



Chipsmall Limited consists of a professional team with an average of over 10 year of expertise in the distribution of electronic components. Based in Hongkong, we have already established firm and mutual-benefit business relationships with customers from,Europe,America and south Asia,supplying obsolete and hard-to-find components to meet their specific needs.

With the principle of “Quality Parts,Customers Priority,Honest Operation,and Considerate Service”,our business mainly focus on the distribution of electronic components. Line cards we deal with include Microchip,ALPS,ROHM,Xilinx,Pulse,ON,Everlight and Freescale. Main products comprise IC,Modules,Potentiometer,IC Socket,Relay,Connector.Our parts cover such applications as commercial,industrial, and automotives areas.

We are looking forward to setting up business relationship with you and hope to provide you with the best service and solution. Let us make a better world for our industry!



## Contact us

Tel: +86-755-8981 8866 Fax: +86-755-8427 6832

Email & Skype: info@chipsmall.com Web: www.chipsmall.com

Address: A1208, Overseas Decoration Building, #122 Zhenhua RD., Futian, Shenzhen, China



## PolarHV™ HiPerFET Power MOSFET

## IXFC14N60P

(Electrically Isolated Back Surface)

N-Channel Enhancement Mode  
Avalanche Rated  
Fast Intrinsic Diode

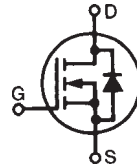

$$\begin{aligned} V_{DSS} &= 600V \\ I_{D25} &= 8A \\ R_{DS(on)} &\leq 630m\Omega \\ t_{rr} &\leq 200ns \end{aligned}$$

| Symbol        | Test Conditions  | Maximum Ratings    |            |
|---------------|--|--------------------|------------|
| $V_{DSS}$     | $T_J = 25^\circ C$ to $150^\circ C$                                | 600                | V          |
| $V_{DGR}$     | $T_J = 25^\circ C$ to $150^\circ C$ , $R_{GS} = 1M\Omega$          | 600                | V          |
| $V_{GSS}$     | Continuous   | $\pm 30$           | V          |
| $V_{GSM}$     | Transient  | $\pm 40$           | V          |
| $I_{D25}$     | $T_C = 25^\circ C$   | 8                  | A          |
| $I_{DM}$      | $T_C = 25^\circ C$ , pulse width limited by $T_{JM}$               | 42                 | A          |
| $I_A$         | $T_C = 25^\circ C$   | 14                 | A          |
| $E_{AS}$      | $T_C = 25^\circ C$   | 900                | mJ         |
| $dV/dt$       | $I_S \leq I_{DM}$ , $V_{DD} \leq V_{DSS}$ , $T_J \leq 150^\circ C$ | 10                 | V/ns       |
| $P_D$         | $T_C = 25^\circ C$   | 125                | W          |
| $T_J$         |  | -55 ... +150       | $^\circ C$ |
| $T_{JM}$      |  | 150                | $^\circ C$ |
| $T_{stg}$     |  | -55 ... +150       | $^\circ C$ |
| $T_L$         | 1.6mm (0.062 in.) from case for 10s                                | 300                | $^\circ C$ |
| $T_{SOLD}$    | Plastic body for 10s   | 260                | $^\circ C$ |
| $V_{ISOL}$    | 50/60 Hz, RMS  | $t = 1min$ 2500    | V~         |
|               | $I_{ISOL} \leq 1mA$  | $t = 1s$ 3000      | V~         |
| $M_d$         | Mounting force   | 11..66 / 2.5..14.6 | N/lb.      |
| <b>Weight</b> |  | 2                  | g          |

ISOPLUS 220™

E153432

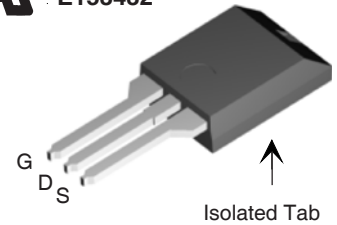

G = Gate      D = Drain  
S = Source

### Features

- UL recognized package
- Silicon chip on Direct-Copper-Bond substrate
  - High power dissipation
  - Isolated mounting surface
  - 2500V electrical isolation
- Avalanche rated
- Fast intrinsic diode

### Advantages

- Easy to mount
- Space savings
- High power density

### Applications:

- Switched-mode and resonant-mode power supplies
- DC-DC Converters
- Laser Drivers
- AC and DC motor drives
- Robotics and servo controls

| Symbol       | Test Conditions<br>( $T_J = 25^\circ C$ , unless otherwise specified) | Characteristic Values |      |                          |
|--------------|---|-----------------------|------|--------------------------|
|              |   | Min.                  | Typ. | Max.                     |
| $BV_{DSS}$   | $V_{GS} = 0V$ , $I_D = 250\mu A$                                      | 600                   |      | V                        |
| $V_{GS(th)}$ | $V_{DS} = V_{GS}$ , $I_D = 2.5mA$                                     | 3.0                   |      | 5.5 V                    |
| $I_{GSS}$    | $V_{GS} = \pm 30V$ , $V_{DS} = 0V$                                    |                       |      | $\pm 100$ nA             |
| $I_{DSS}$    | $V_{DS} = V_{DSS}$<br>$V_{GS} = 0V$<br>$T_J = 125^\circ C$            |                       |      | 5 $\mu A$<br>500 $\mu A$ |
| $R_{DS(on)}$ | $V_{GS} = 10V$ , $I_D = 7A$ , Note 1                                  |                       |      | 630 $m\Omega$            |

| Symbol       | Test Conditions<br>( $T_J = 25^\circ\text{C}$ , unless otherwise specified)   | Characteristic Values |      |                    |
|--------------|---|-----------------------|------|--------------------|
|              |   | Min.                  | Typ. | Max.               |
| $g_{fs}$     | $V_{DS} = 20\text{V}$ , $I_D = 7\text{A}$ , Note 1  | 7                     | 13   | S                  |
| $C_{iss}$    | $V_{GS} = 0\text{V}$ , $V_{DS} = 25\text{V}$ , $f = 1\text{MHz}$  |                       | 2500 | pF                 |
| $C_{oss}$    |   |                       | 215  | pF                 |
| $C_{rss}$    |   |                       | 13   | pF                 |
| $t_{d(on)}$  | <b>Resistive Switching Times</b><br>$V_{GS} = 10\text{V}$ , $V_{DS} = 0.5 \cdot V_{DSS}$ , $I_D = 7\text{A}$<br>$R_G = 10\Omega$ (External) |                       | 23   | ns                 |
| $t_r$        |   |                       | 27   | ns                 |
| $t_{d(off)}$ |   |                       | 70   | ns                 |
| $t_f$        |   |                       | 26   | ns                 |
| $Q_{g(on)}$  | $V_{GS} = 10\text{V}$ , $V_{DS} = 0.5 \cdot V_{DSS}$ , $I_D = 7\text{A}$  |                       | 36   | nC                 |
| $Q_{gs}$     |   |                       | 16   | nC                 |
| $Q_{gd}$     |   |                       | 12   | nC                 |
| $R_{thJC}$   |   |                       | 1.00 | $^\circ\text{C/W}$ |
| $R_{thCS}$   |   | 0.21                  |      | $^\circ\text{C/W}$ |

### Source-Drain Diode

| Symbol   | Test Conditions<br>( $T_J = 25^\circ\text{C}$ , unless otherwise specified)                           | Characteristic Values |      |        |
|----------|---|-----------------------|------|--------|
|          |   | Min.                  | Typ. | Max.   |
| $I_S$    | $V_{GS} = 0\text{V}$  |                       |      | 14 A   |
| $I_{SM}$ | Repetitive, pulse width limited by $T_{JM}$   |                       |      | 42 A   |
| $V_{SD}$ | $I_F = I_S$ , $V_{GS} = 0\text{V}$ , Note 1   |                       |      | 1.5 V  |
| $t_{rr}$ | $I_F = 14\text{A}$ , $-di/dt = 100\text{A}/\mu\text{s}$<br>$V_R = 100\text{V}$ , $V_{GS} = 0\text{V}$ |                       |      | 200 ns |
| $Q_{RM}$ |   |                       | 6.0  | nC     |
| $I_{RM}$ |   |                       | 0.6  | A      |

Note 1: Pulse test,  $t \leq 300\mu\text{s}$ ; duty cycle,  $d \leq 2\%$ .

### ISOPLUS220™ (IXFC) Outline

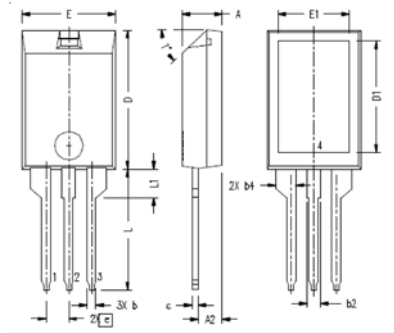

Note:  
Bottom heatsink (Pin 4) is electrically isolated from Pin 1, 2, or 3.

| SYM | INCHES     |      | MILLIMETERS |       |
|-----|------------|------|-------------|-------|
|     | MIN        | MAX  | MIN         | MAX   |
| A   | .157       | .197 | 4.00        | 5.00  |
| A2  | .098       | .118 | 2.50        | 3.00  |
| b   | .035       | .051 | 0.90        | 1.30  |
| b2  | .049       | .065 | 1.25        | 1.65  |
| b4  | .093       | .100 | 2.35        | 2.55  |
| c   | .028       | .039 | 0.70        | 1.00  |
| D   | .591       | .630 | 15.00       | 16.00 |
| D1  | .472       | .512 | 12.00       | 13.00 |
| E   | .394       | .433 | 10.00       | 11.00 |
| E1  | .295       | .335 | 7.50        | 8.50  |
| e   | .100 BASIC |      | 2.55 BASIC  |       |
| L   | .512       | .571 | 13.00       | 14.50 |
| L1  | .118       | .138 | 3.00        | 3.50  |
| T*  |            |      | 42.5*       | 47.5* |

Ref: IXYS CO 0177 R0

IXYS reserves the right to change limits, test conditions, and dimensions.

|  |           |           |           |           |              |              |              |              |              |             |
|--|-----------|-----------|-----------|-----------|--------------|--------------|--------------|--------------|--------------|-------------|
| IXYS MOSFETs and IGBTs are covered by one or more of the following U.S. patents: | 4,835,592 | 4,931,844 | 5,049,961 | 5,237,481 | 6,162,665    | 6,404,065 B1 | 6,683,344    | 6,727,585    | 7,005,734 B2 | 7,157,338B2 |
|  | 4,850,072 | 5,017,508 | 5,063,307 | 5,381,025 | 6,259,123 B1 | 6,534,343    | 6,710,405 B2 | 6,759,692    | 7,063,975 B2 |             |
|  | 4,881,106 | 5,034,796 | 5,187,117 | 5,486,715 | 6,306,728 B1 | 6,583,505    | 6,710,463    | 6,771,478 B2 | 7,071,537    |             |

**Fig. 1. Output Characteristics @ 25°C**

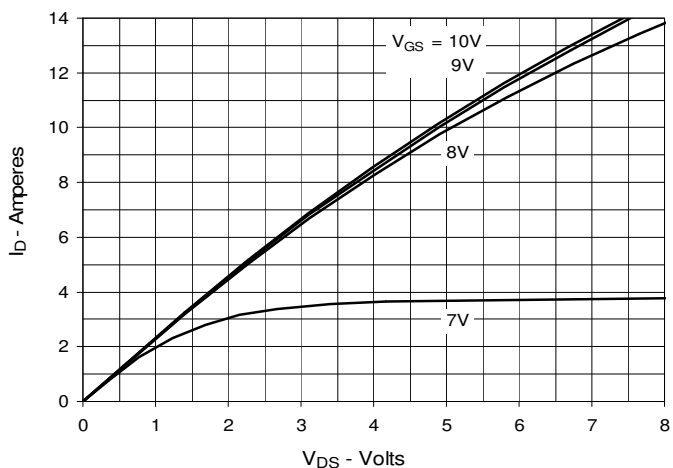

**Fig. 2. Extended Output Characteristics @ 25°C**

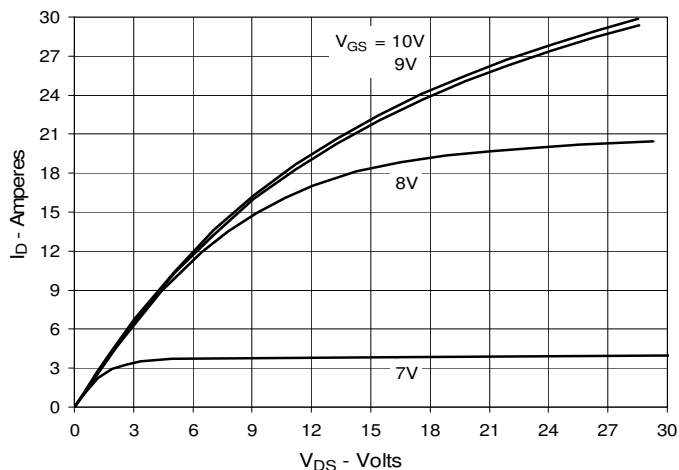

**Fig. 3. Output Characteristics @ 125°C**

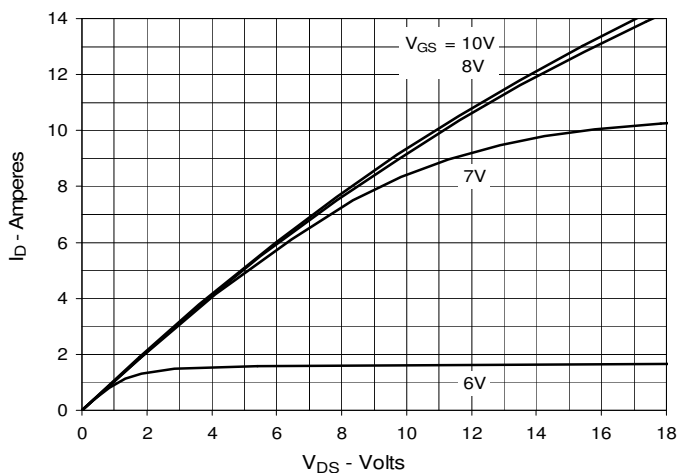

**Fig. 4.  $R_{DS(on)}$  Normalized to  $I_D = 7A$  Value vs. Junction Temperature**

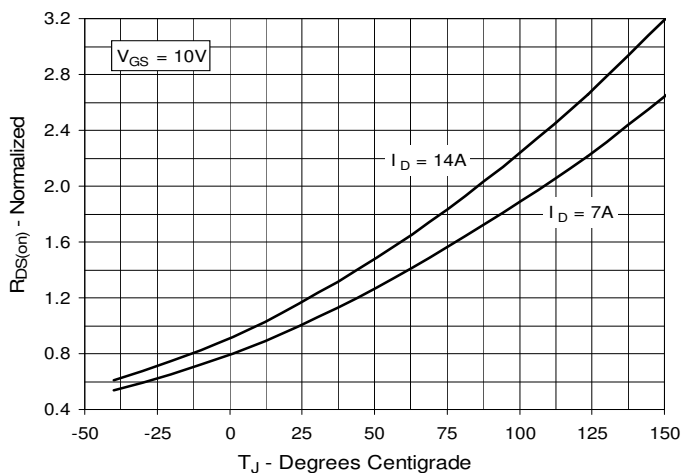

**Fig. 5.  $R_{DS(on)}$  Normalized to  $I_D = 7A$  Value vs. Drain Current**

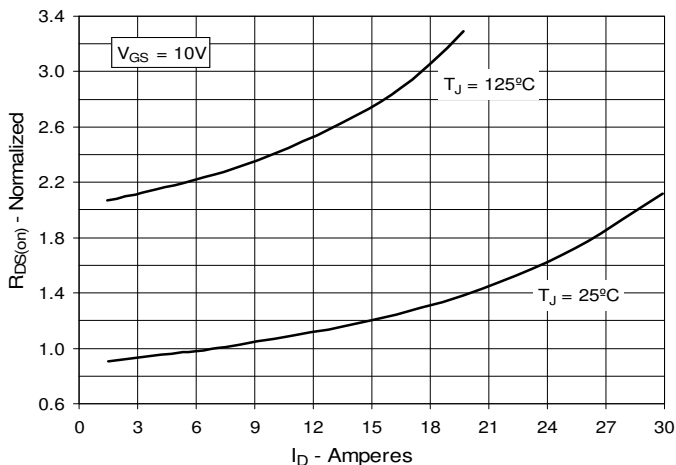

**Fig. 6. Maximum Drain Current vs. Case Temperature**

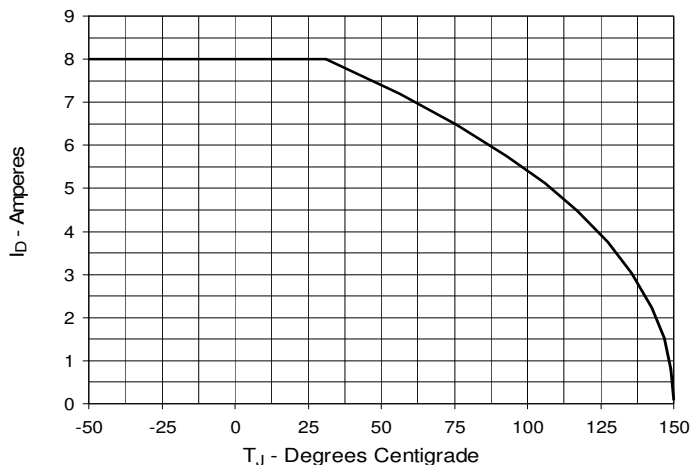

**Fig. 7. Input Admittance**

**Fig. 8. Transconductance**

**Fig. 9. Forward Voltage Drop of Intrinsic Diode**

**Fig. 10. Gate Charge**

**Fig. 11. Capacitance**

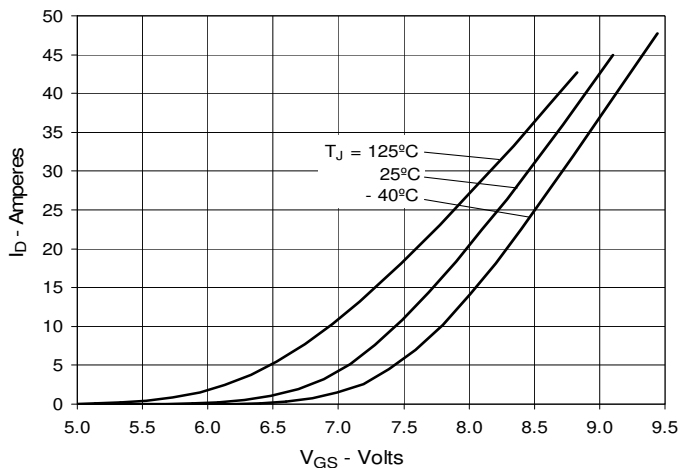
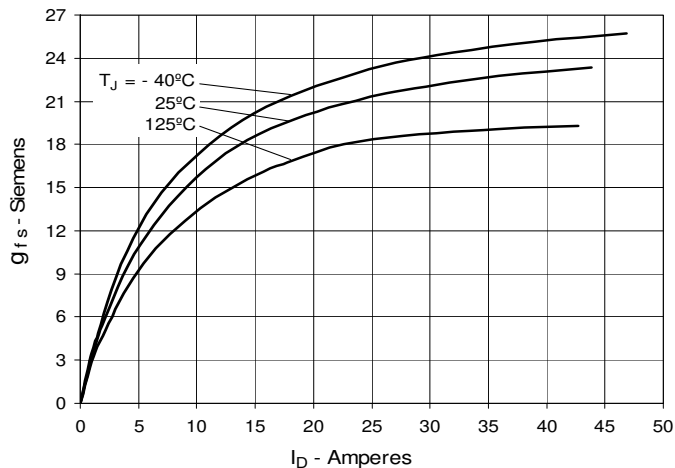
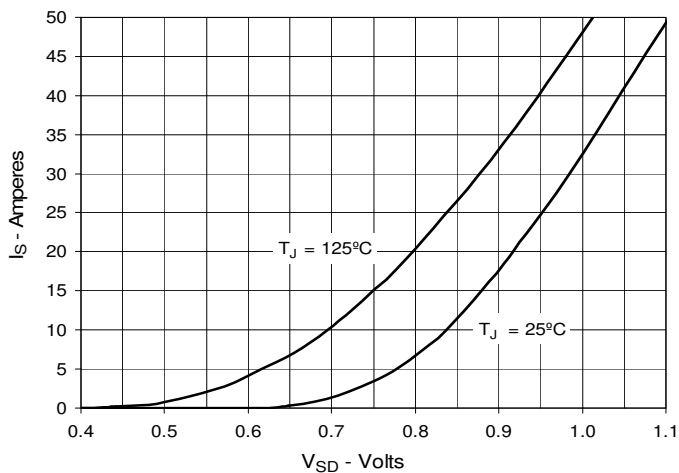
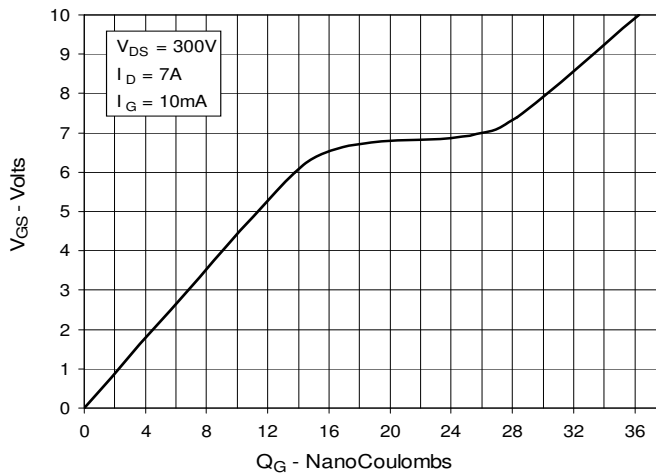
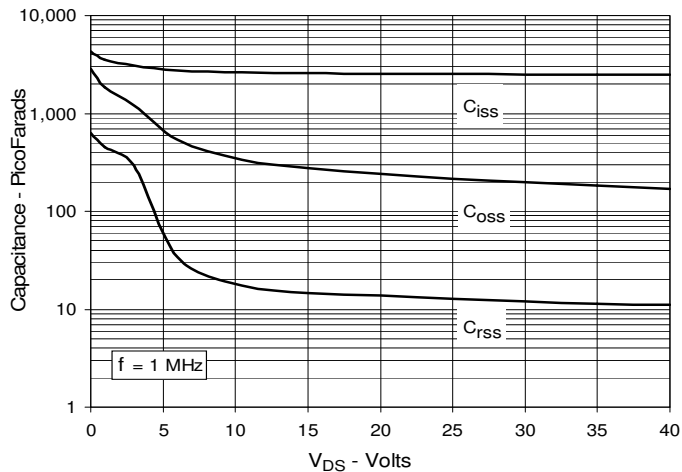
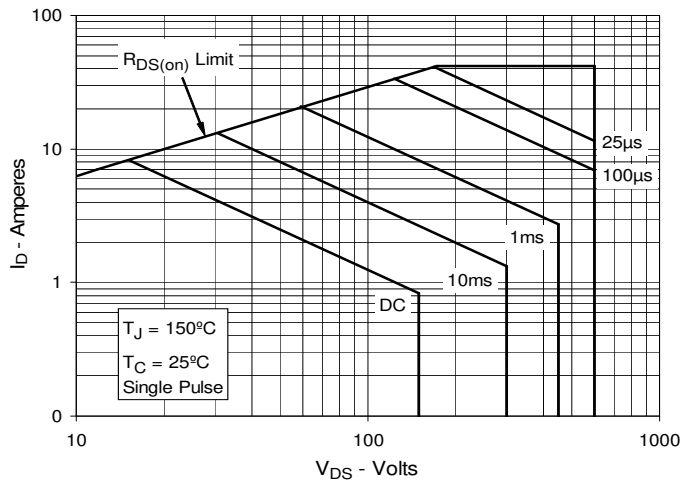
**Fig. 12. Forward-Bias Safe Operating Area**

Fig. 13. Maximum Transient Thermal Impedance

