



Chipsmall Limited consists of a professional team with an average of over 10 year of expertise in the distribution of electronic components. Based in Hongkong, we have already established firm and mutual-benefit business relationships with customers from,Europe,America and south Asia,supplying obsolete and hard-to-find components to meet their specific needs.

With the principle of “Quality Parts,Customers Priority,Honest Operation,and Considerate Service”,our business mainly focus on the distribution of electronic components. Line cards we deal with include Microchip,ALPS,ROHM,Xilinx,Pulse,ON,Everlight and Freescale. Main products comprise IC,Modules,Potentiometer,IC Socket,Relay,Connector.Our parts cover such applications as commercial,industrial, and automotives areas.

We are looking forward to setting up business relationship with you and hope to provide you with the best service and solution. Let us make a better world for our industry!



Contact us

Tel: +86-755-8981 8866 Fax: +86-755-8427 6832

Email & Skype: info@chipsmall.com Web: www.chipsmall.com

Address: A1208, Overseas Decoration Building, #122 Zhenhua RD., Futian, Shenzhen, China



Polar™ Power MOSFET

HiPerFET™

N-Channel Enhancement Mode
Avalanche Rated
Fast Intrinsic Diode

IXFH20N100P

IXFT20N100P

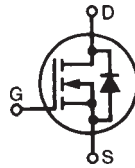

$V_{DSS} = 1000V$
 $I_{D25} = 20A$
 $R_{DS(on)} \leq 570m\Omega$
 $t_{rr} \leq 300ns$

| Symbol | Test Conditions | Maximum Ratings | |
|------------|--|-----------------|------------|
| V_{DSS} | $T_J = 25^\circ C$ to $150^\circ C$ | 1000 | V |
| V_{DGR} | $T_J = 25^\circ C$ to $150^\circ C$, $R_{GS} = 1M\Omega$ | 1000 | V |
| V_{GSS} | Continuous | ± 30 | V |
| V_{GSM} | Transient | ± 40 | V |
| I_{D25} | $T_C = 25^\circ C$ | 20 | A |
| I_{DM} | $T_C = 25^\circ C$, pulse width limited by T_{JM} | 50 | A |
| I_{AR} | $T_C = 25^\circ C$ | 10 | A |
| E_{AS} | $T_C = 25^\circ C$ | 800 | mJ |
| dV/dt | $I_S \leq I_{DM}$, $V_{DD} \leq V_{DSS}$, $T_J \leq 150^\circ C$ | 15 | V/ns |
| P_D | $T_C = 25^\circ C$ | 660 | W |
| T_J | | -55 ... +150 | $^\circ C$ |
| T_{JM} | | 150 | $^\circ C$ |
| T_{stg} | | -55 ... +150 | $^\circ C$ |
| T_L | Maximum lead temperature for soldering | 300 | $^\circ C$ |
| T_{SOLD} | Plastic body for 10s | 260 | $^\circ C$ |
| M_d | Mounting torque (TO-247) | 1.13/10 | Nm/lb.in. |
| Weight | TO-247 | 6 | g |
| | TO-268 | 5 | g |

TO-247 (IXFH)

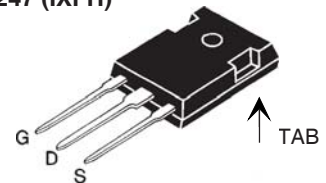

TO-268 (IXFT)

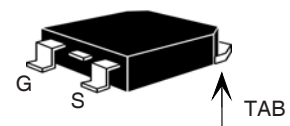

G = Gate D = Drain
S = Source TAB = Drain

Features

- International standard packages
- Fast recovery diode
- Unclamped Inductive Switching (UIS) rated
- Low package inductance
 - easy to drive and to protect

Advantages

- Easy to mount
- Space savings
- High power density

Applications:

- Switched-mode and resonant-mode power supplies
- DC-DC Converters
- Laser Drivers
- AC and DC motor controls
- Robotics and servo controls

| Symbol | Test Conditions | Characteristic Values | | |
|--------------|---|-----------------------|------|--------------|
| | | Min. | Typ. | Max. |
| BV_{DSS} | $V_{GS} = 0V$, $I_D = 1mA$ | 1000 | | V |
| $V_{GS(th)}$ | $V_{DS} = V_{GS}$, $I_D = 1mA$ | 3.5 | | 6.5 V |
| I_{GSS} | $V_{GS} = \pm 30V$, $V_{DS} = 0V$ | | | ± 200 nA |
| I_{DSS} | $V_{DS} = V_{DSS}$ $V_{GS} = 0V$ | $T_J = 125^\circ C$ | | 25 μA |
| | | | | 1.5 mA |
| $R_{DS(on)}$ | $V_{GS} = 10V$, $I_D = 0.5 \cdot I_{D25}$, Note 1 | 470 | 570 | m Ω |

| Symbol | Test Conditions ($T_J = 25^\circ\text{C}$ unless otherwise specified) | Characteristic Values | | |
|--------------|--|-----------------------|------|-------------------------|
| | | Min. | Typ. | Max. |
| g_{fs} | $V_{DS} = 20\text{V}, I_D = 0.5 \cdot I_{D25}$, Note 1 | 8 | 14 | S |
| C_{iss} | $V_{GS} = 0\text{V}, V_{DS} = 25\text{V}, f = 1\text{MHz}$ | | 7300 | pF |
| C_{oss} | | | 456 | pF |
| C_{rss} | | | 55 | pF |
| R_{Gi} | Gate input resistance | | 1.20 | Ω |
| $t_{d(on)}$ | Resistive Switching Times $V_{GS} = 10\text{V}, V_{DS} = 0.5 \cdot V_{DSS}, I_D = 0.5 \cdot I_{D25}$ $R_G = 2\Omega$ (External) | | 40 | ns |
| t_r | | | 37 | ns |
| $t_{d(off)}$ | | | 56 | ns |
| t_f | | | 45 | ns |
| $Q_{g(on)}$ | $V_{GS} = 10\text{V}, V_{DS} = 0.5 \cdot V_{DSS}, I_D = 0.5 \cdot I_{D25}$ | | 126 | nC |
| Q_{gs} | | | 50 | nC |
| Q_{gd} | | | 55 | nC |
| R_{thJC} | (TO-247) | | | 0.19 $^\circ\text{C/W}$ |
| R_{thCS} | | | 0.21 | $^\circ\text{C/W}$ |

| Source-Drain Diode | | Characteristic Values | | |
|--|---|-----------------------|------|--------|
| $T_J = 25^\circ\text{C}$ unless otherwise specified) | | Min. | Typ. | Max. |
| I_S | $V_{GS} = 0\text{V}$ | | | 20 A |
| I_{SM} | Repetitive, pulse width limited by T_{JM} | | | 80 A |
| V_{SD} | $I_F = I_S, V_{GS} = 0\text{V}$, Note 1 | | | 1.5 V |
| t_{rr} | $I_F = 10\text{A}, -di/dt = 100\text{A}/\mu\text{s}$ $V_R = 100\text{V}, V_{GS} = 0\text{V}$ | | | 300 ns |
| Q_{RM} | | | 0.9 | |
| I_{RM} | | | 9.0 | A |

Note 1: Pulse test, $t \leq 300\mu\text{s}$; duty cycle, $d \leq 2\%$.

TO-247 (IXFH) Outline

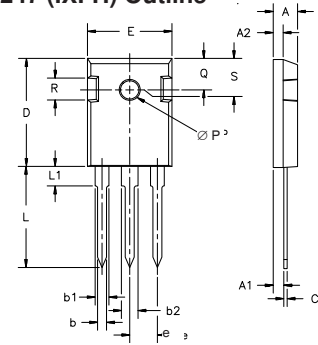

| Dim. | Millimeter | | Inches | |
|----------------|------------|-------|--------|-------|
| | Min. | Max. | Min. | Max. |
| A | 4.7 | 5.3 | .185 | .209 |
| A ₁ | 2.2 | 2.54 | .087 | .102 |
| A ₂ | 2.2 | 2.6 | .087 | .102 |
| b | 1.0 | 1.4 | .040 | .055 |
| b ₁ | 1.65 | 2.13 | .065 | .084 |
| b ₂ | 2.87 | 3.12 | .113 | .123 |
| C | .4 | .8 | .016 | .031 |
| D | 20.80 | 21.46 | .819 | .845 |
| E | 15.75 | 16.26 | .610 | .640 |
| e | 5.20 | 5.72 | 0.205 | 0.225 |
| L | 19.81 | 20.32 | .780 | .800 |
| L ₁ | | 4.50 | | .177 |
| ∅P | 3.55 | 3.65 | .140 | .144 |
| Q | 5.89 | 6.40 | 0.232 | 0.252 |
| R | 4.32 | 5.49 | .170 | .216 |
| S | 6.15 | BSC | 242 | BSC |

TO-268 Outline

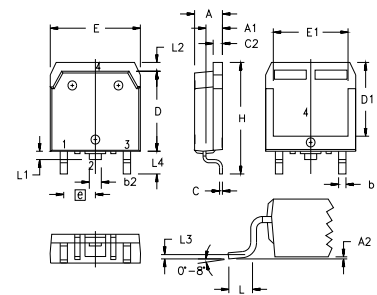

| SYM | INCHES | | MILLIMETERS | |
|----------------|----------|------|-------------|-------|
| | MIN | MAX | MIN | MAX |
| A | .193 | .201 | 4.90 | 5.10 |
| A ₁ | .106 | .114 | 2.70 | 2.90 |
| A ₂ | .001 | .010 | 0.02 | 0.25 |
| b | .045 | .057 | 1.15 | 1.45 |
| b ₂ | .075 | .083 | 1.90 | 2.10 |
| C | .016 | .026 | 0.40 | 0.65 |
| C ₂ | .057 | .063 | 1.45 | 1.60 |
| D | .543 | .551 | 13.80 | 14.00 |
| D ₁ | .488 | .500 | 12.40 | 12.70 |
| E | .624 | .632 | 15.85 | 16.05 |
| E ₁ | .524 | .535 | 13.30 | 13.60 |
| e | .215 BSC | | 5.45 BSC | |
| H | .736 | .752 | 18.70 | 19.10 |
| L | .094 | .106 | 2.40 | 2.70 |
| L ₁ | .047 | .055 | 1.20 | 1.40 |
| L ₂ | .039 | .045 | 1.00 | 1.15 |
| L ₃ | .010 BSC | | 0.25 BSC | |
| L ₄ | .150 | .161 | 3.80 | 4.10 |

IXYS reserves the right to change limits, test conditions, and dimensions.

IXYS MOSFETs and IGBTs are covered 4,835,592 4,931,844 5,049,961 5,237,481 6,162,665 6,404,065 B1 6,683,344 6,727,585 7,005,734 B2 7,157,338B2
by one or more of the following U.S. patents: 4,850,072 5,017,508 5,063,307 5,381,025 6,259,123 B1 6,534,343 6,710,405 B2 6,759,692 7,063,975 B2
4,881,106 5,034,796 5,187,117 5,486,715 6,306,728 B1 6,583,505 6,710,463 6,771,478 B2 7,071,537

Fig. 1. Output Characteristics @ 25°C

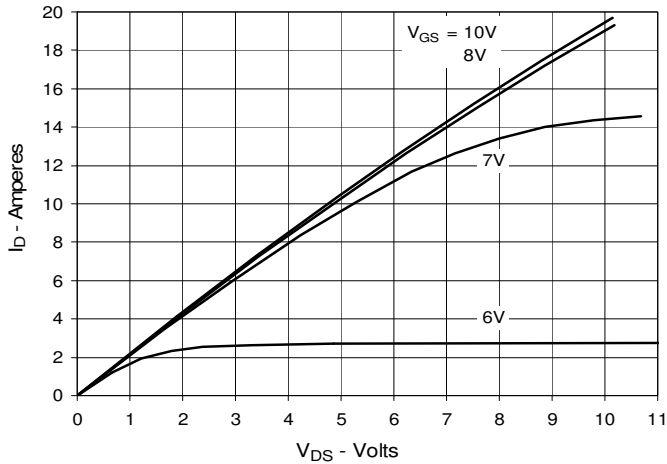

Fig. 2. Extended Output Characteristics @ 25°C

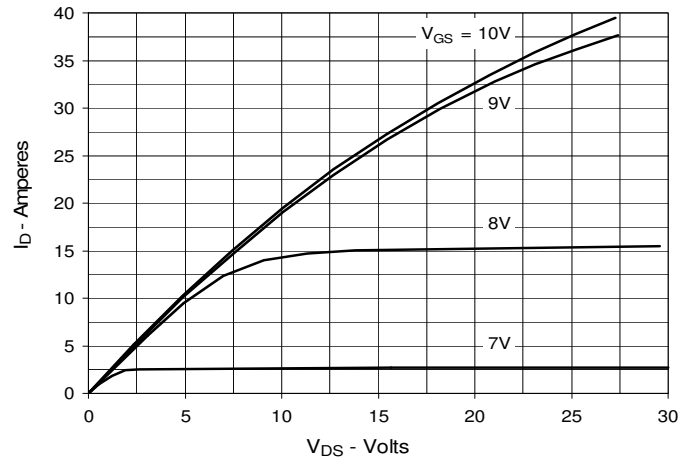

Fig. 3. Output Characteristics @ 125°C

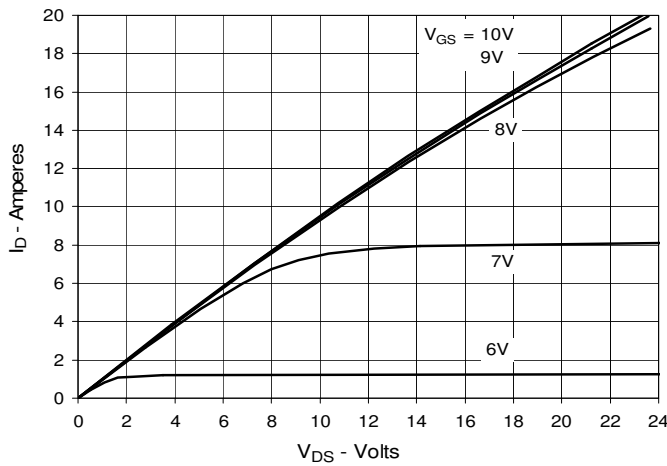

Fig. 4. $R_{DS(on)}$ Normalized to $I_D = 10A$ Value vs. Junction Temperature

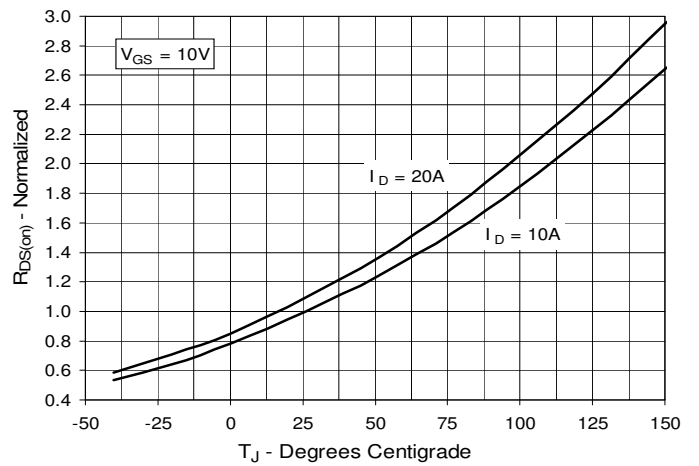

Fig. 5. $R_{DS(on)}$ Normalized to $I_D = 10A$ Value vs. Drain Current

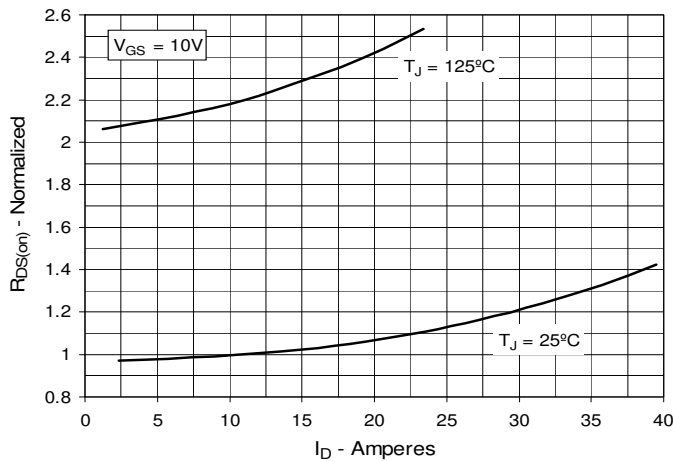

Fig. 6. Maximum Drain Current vs. Case Temperature

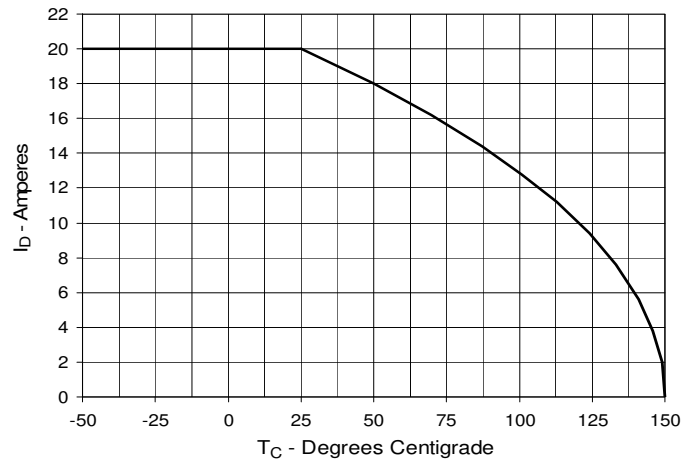

Fig. 7. Input Admittance

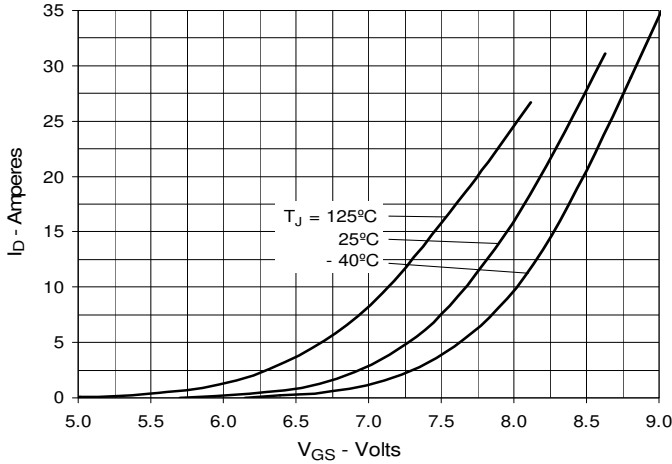

Fig. 8. Transconductance

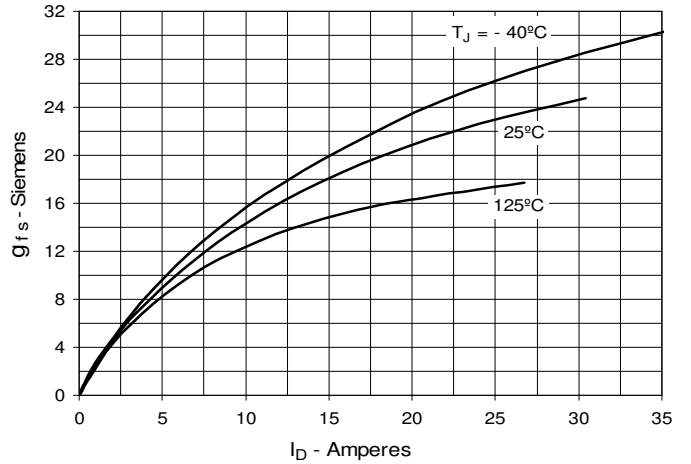

Fig. 9. Forward Voltage Drop of Intrinsic Diode

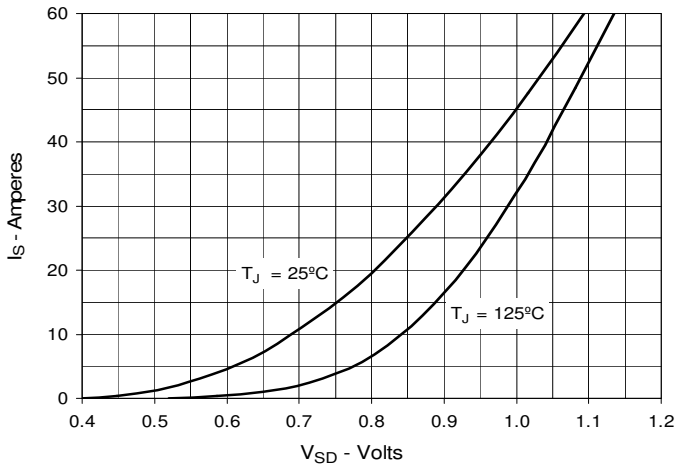

Fig. 10. Gate Charge

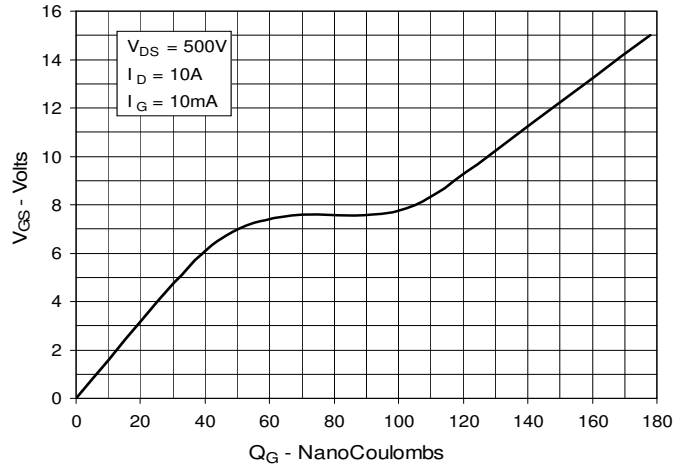

Fig. 11. Capacitance

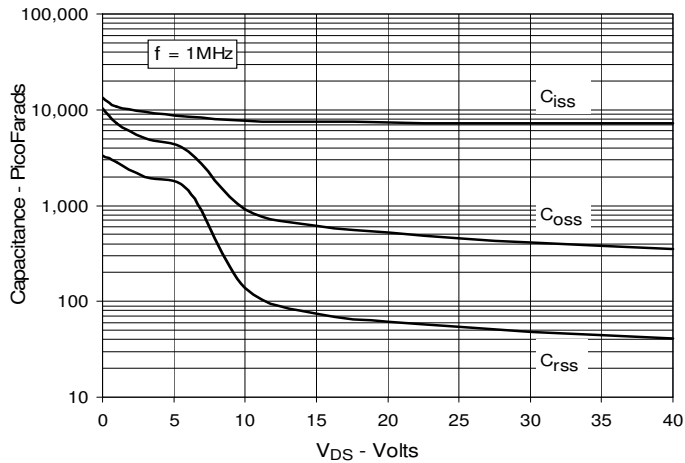
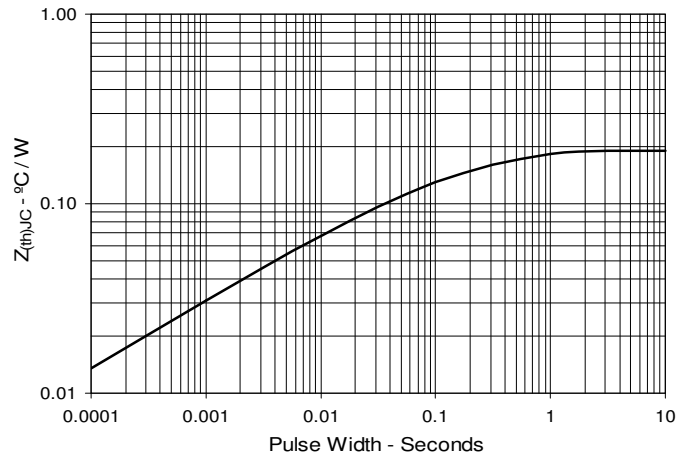

Fig. 12. Maximum Transient Thermal Impedance



IXYS reserves the right to change limits, test conditions, and dimensions.