



Chipsmall Limited consists of a professional team with an average of over 10 year of expertise in the distribution of electronic components. Based in Hongkong, we have already established firm and mutual-benefit business relationships with customers from,Europe,America and south Asia,supplying obsolete and hard-to-find components to meet their specific needs.

With the principle of “Quality Parts,Customers Priority,Honest Operation,and Considerate Service”,our business mainly focus on the distribution of electronic components. Line cards we deal with include Microchip,ALPS,ROHM,Xilinx,Pulse,ON,Everlight and Freescale. Main products comprise IC,Modules,Potentiometer,IC Socket,Relay,Connector.Our parts cover such applications as commercial,industrial, and automotives areas.

We are looking forward to setting up business relationship with you and hope to provide you with the best service and solution. Let us make a better world for our industry!



## Contact us

Tel: +86-755-8981 8866 Fax: +86-755-8427 6832

Email & Skype: info@chipsmall.com Web: www.chipsmall.com

Address: A1208, Overseas Decoration Building, #122 Zhenhua RD., Futian, Shenzhen, China



# IX series

Pushbutton switches for harsh environments •  
bushing Ø 12 mm • momentary NO & NC/NO



## DISTINCTIVE FEATURES

Backlighted marking in a compact case

Strong tactile feedback

NO or NC/NO

High sealing level, no space between actuator and bushing (IP67/IP69K)



## ENVIRONMENTAL SPECIFICATIONS

- Operating and storage temperature : -40 °C to +85 °C (-40 °F to +185 °F)
- Front panel sealing : IP67 according to IEC 60529, IP69K according to DIN 40050-9
- Shock resistance: 100 g according to IEC 512-4, test 6c
- Salt spray: IEC 512-6, test 11f



## ELECTRICAL SPECIFICATIONS

- Max. current/voltage rating with resistive load:
  - Gold plated contact (0): 100 mA 28 VDC, 1,000,000 cycles
  - Silver contact (1): 2 A 28 VDC, 100,000 cycles
- Initial contact resistance : 100 mΩ max.
- Insulation resistance : 1 GΩ min. at 500 VDC
- Dielectric strength : 1,500 Vrms
- Contact bounce : 10 ms



### LED COMPONENT SPECIFICATIONS

LED color	Forward current	Typ. forward voltage	Max. forward voltage
Red (R)	20 mA	1.9 V	2.5 V
Yellow (Y)	20 mA	2.3 V	2.8 V
Green (G)	20 mA	4 V	4.5 V
Blue (B)	20 mA	3.2 V	3.7 V
White (W)	20 mA	3.3 V	4 V
Red/green (F)	20 mA	Red: 2 V / green: 3.2 V	Red: 2.8 V / green: 3.7 V

A resistor must be series-connected by the user.  
Resistor value =  $\frac{\text{supply voltage} - \text{LED forward voltage}}{\text{LED forward current}}$

The company reserves the right to change specifications without notice.

# IX series

Pushbutton switches for harsh environments •  
bushing Ø 12 mm • momentary NO & NC/NO

## GENERAL SPECIFICATIONS

- Panel thickness : 1.5 to 6 mm
- Total travel : 2 mm (.078) ± 0.3 mm
- Typical operating force : 7 N ± 2 N
- Low level/mech. life : 1,000,000 cycles
- Torque : 0.55 Nm (0.6 Nm max.) applied to nut
- Soldering : 320 °C (608 °F) max. for 3 sec.

## MATERIALS

- Case : thermoplastic UL94-V0
- Actuator : silicone
- Bushing : ABS UL94 HB
- Contacts :
  - 0 : brass, gold plated
  - 1 : silver
- Output wires : AWG24, section 0.23 mm<sup>2</sup> - 500 mm
- Terminal seal : epoxy

APEM products may be recycled at end-of-life for the re-claiming of valuable metal components.

## CONNECTIONS

### WIRES TERMINALS

- Contact NO : black color / Contact NC : blue color
- LED : + : red color  
- : white color

## TERMINALS

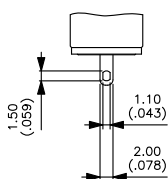

Solder lug S

## ELECTRICAL FUNCTION

### ILLUMINATED MODELS

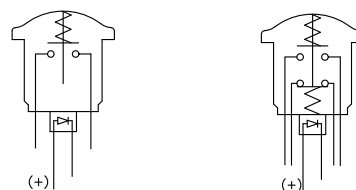

Function 3 (NO)

Function 5 (NC/NO)

### NON-ILLUMINATED MODELS

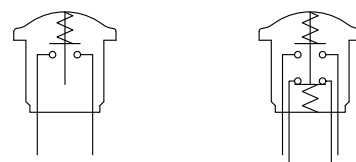

Function 3 (NO)

Function 5 (NC/NO)

## MOUNTING

### PANEL CUT-OUT

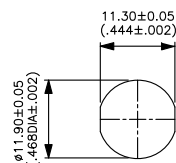

### MATRIX MOUNTING

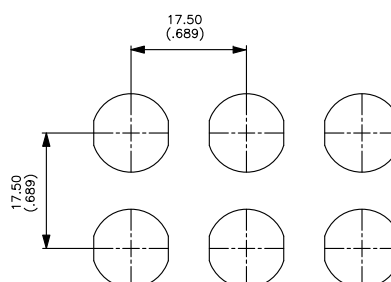



Pushbutton switches for harsh environments •  
bushing Ø 12 mm • momentary NO & NC/NO



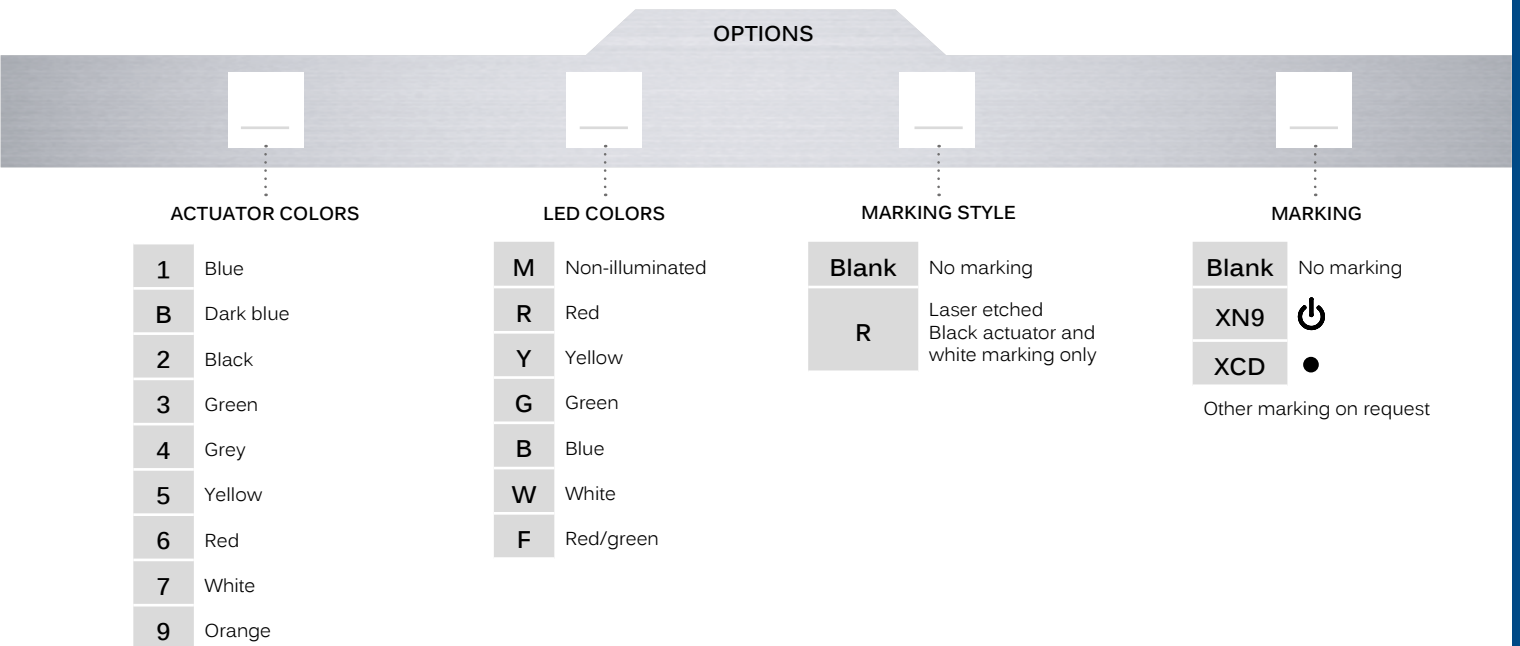
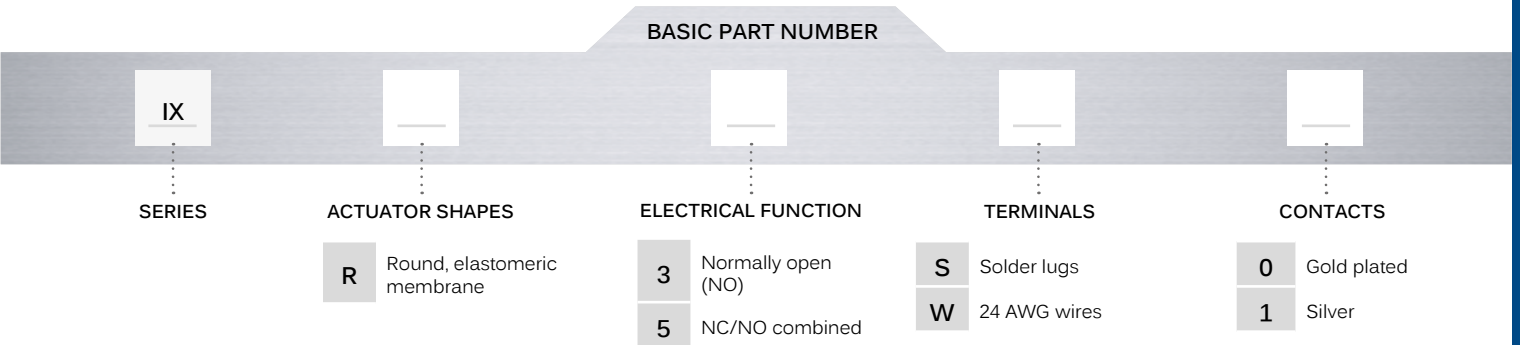

## BUILD YOUR PART NUMBER



## ABOUT THIS SERIES

On the following pages, you will find successively basic part numbers of switches and options in the same order as in above chart.

-  **Notice** : please note that not all combinations of above numbers are available. Refer to the following pages for further information.
-  **Mounting accessories** : Standard hardware supplied : 1 hex nut 14 mm (.551) across flats and 1 O-Ring.

# IX series

Pushbutton switches for harsh environments •  
bushing Ø 12 mm • momentary NO & NC/NO

**SOLDER LUG TERMINALS  
NON-ILLUMINATED - NO**



IXR3S••M

**SOLDER LUG TERMINALS  
NON-ILLUMINATED - NC/NO**



IXR5S••M

**SOLDER LUG TERMINALS  
ILLUMINATED - NC/NO**



IXR5S

**FLYING LEAD TERMINALS  
ILLUMINATED - NC/NO**



IXR5W

→ FLAT

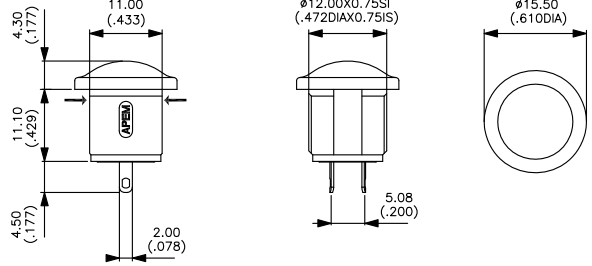

→ FLAT

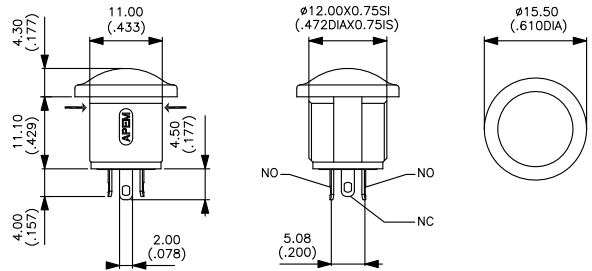

→ FLAT

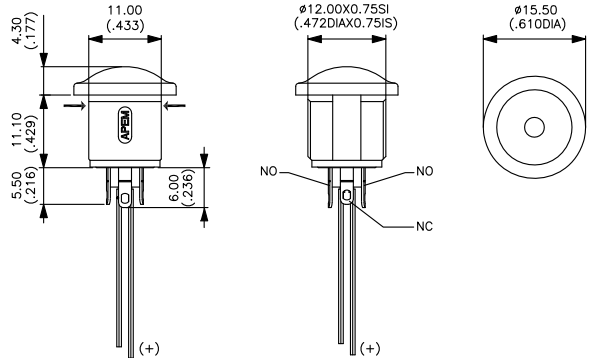

→ FLAT

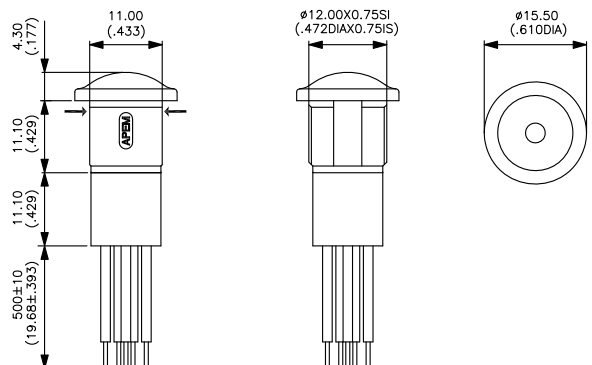

# IX series

Pushbutton switches for harsh environments •  
bushing Ø 12 mm • momentary NO & NC/NO

## ACTUATOR COLORS



- |   |           |   |        |
|---|-----------|---|--------|
| 1 | Blue      | 5 | Yellow |
| B | Dark blue | 6 | Red    |
| 2 | Black     | 7 | White  |
| 3 | Green     | 9 | Orange |
| 4 | Grey      |   |        |

## LED COLORS



- |   |                 |
|---|-----------------|
| M | Non-illuminated |
| R | Red             |
| Y | Yellow          |
| G | Green           |
| B | Blue            |
| W | White           |
| F | Red/green       |



## MARKING STYLE



- |       |  |
|-------|--|
| Blank | No marking   |
| R     | Laser etched - Black actuator and white marking only |

## MARKING



- |       |  |
|-------|--|
| Blank | No Marking   |
| XN9   |  - Symbol "power" |
| XCD   |  - Symbol "dot"   |

Other marking on request