



Chipsmall Limited consists of a professional team with an average of over 10 year of expertise in the distribution of electronic components. Based in Hongkong, we have already established firm and mutual-benefit business relationships with customers from,Europe,America and south Asia,supplying obsolete and hard-to-find components to meet their specific needs.

With the principle of “Quality Parts,Customers Priority,Honest Operation,and Considerate Service”,our business mainly focus on the distribution of electronic components. Line cards we deal with include Microchip,ALPS,ROHM,Xilinx,Pulse,ON,Everlight and Freescale. Main products comprise IC,Modules,Potentiometer,IC Socket,Relay,Connector.Our parts cover such applications as commercial,industrial, and automotives areas.

We are looking forward to setting up business relationship with you and hope to provide you with the best service and solution. Let us make a better world for our industry!



Contact us

Tel: +86-755-8981 8866 Fax: +86-755-8427 6832

Email & Skype: info@chipsmall.com Web: www.chipsmall.com

Address: A1208, Overseas Decoration Building, #122 Zhenhua RD., Futian, Shenzhen, China





GP100 Rectifier Backplane

150044268 (J2014001L901)

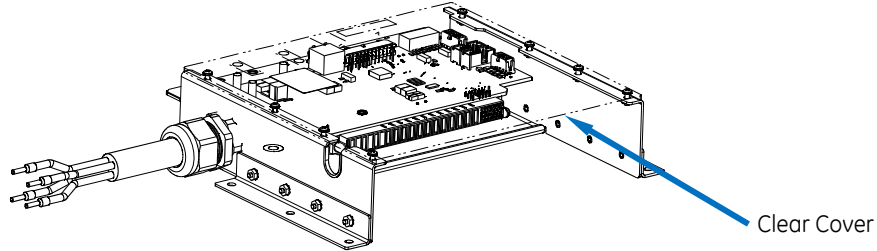

Read and follow all safety statements, warnings, and precautions in this guide.

The backplane is Safety Approved in Service Access locations only. Minimum clearance for cooling airflow: 3" front and rear.

Rectifier retention latch engagement and front mechanical support are not provided by the backplane.

Caution: Equipment Damage

Turn AC power OFF to the backplane before installing or removing rectifiers to avoid damage to the rectifier.
This backplane does not support hot plug in of rectifiers.

Tools required:

Torque wrench - 0-240 in-lb / 28 Nm
Screw Driver - Phillips #2

Sockets- 5/16"

Step 1 - Set Jumpers

Jumpers are on the top under the cover.

Set jumpers per engineering instructions.

- HDR3 not used with I²C
- HDR5 I²C / RS485
- HDR21 I²C A0
- HDR22 Remote ON/OFF enable

1. Remove cover - 8 screws.
2. Set jumpers

Details: See *GP100 Global Platform Line High Efficiency Rectifier Data Sheet*

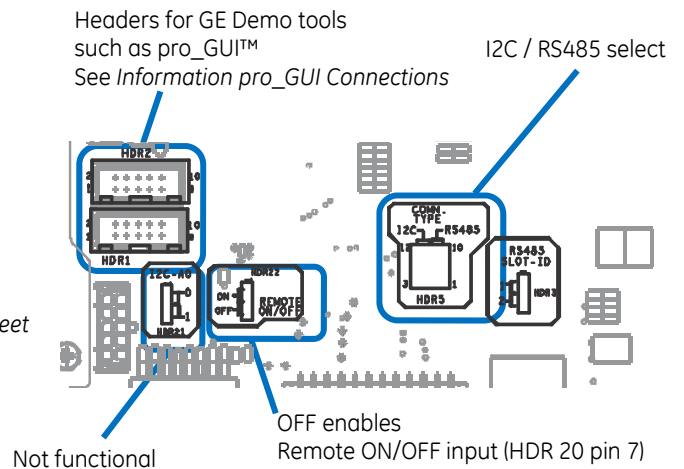

Step 2 - Mount Backplane

Attach the backplane to the frame/rack using a 6 (three on each side) 12-24 screws (provided).
Torque to 35 in-lb - 5/16" socket.

Step 3 - Connect DC Output

DC lug landings are at the top rear, under the cover.

There are no DC output protectors in the shelf.

DC Output - 115A max.

Lug Landings - 10-32 on 5/8" centers

1. Remove cover - 8 screws - if not removed in step 1.
2. Connect wires with suitable lugs to POS and NEG lug landings. Install. Torque to 30 in-lb (3.4 Nm).
3. Install cover - 4 screws.

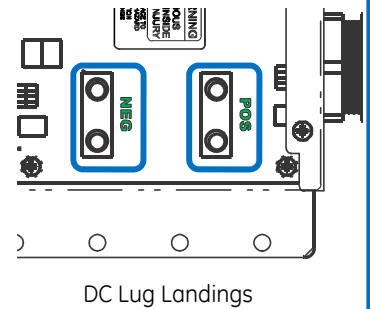

Step 4 - Connect AC Input

Each Rectifier: 380 Vac at 10 A or 480Vac at 8 A.

Danger: Turn OFF and lock-out tag-out the AC source before making AC connections or working on the backplane. When connecting to AC mains, follow all local and national wiring rules.

Caution: When routing AC ensure cables do not come in contact with sharp or rough surfaces that may damage insulation and cause a short circuit.

External AC protector - 30A max.

AC Cable termination - Phoenix 3200535 terminals.

1. Assemble suitable connector housing onto AC cable or cut pins off as required.
2. Connect backplane AC cable to 380/480Vac 3-phase.

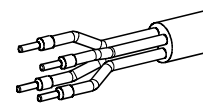

- | | |
|-------|---------|
| Green | Ground |
| Black | Phase A |
| Red | Phase B |
| White | Phase C |

Step 5 - Connect Signals

Connect per engineering instructions.

Connections are to HDR20 "DATA" at the rear of the backplane.

Signal Details: See GP100 Global Platform Line High Efficiency Rectifier Data Sheet

Signal Connector: Housing - Molex 43025-2408 Contacts - Molex Female Terminal series 46235.

Signals - HDR20 "DATA"							
Pin	Signal	Pin	Signal	Pin	Signal	Pin	Signal
1	SDA0	7	REMOTE ON/OFF ¹	13	SCL1	19	STBY_TRIM
2	ALERT0#	8	VPROG	14	LOGIC_GND	20	MOD_PRES
3	LOGIC_GND	9	PFW	15	ALERT1	21	FAULT
4	SDA1	10	ISHARE	16	SCL1	22	8V_INT
5	LOGIC_GND	11	N/C	17	I2CA1_A3 (Rack_ID)	23	PROTOCOL
6	5VA	12	RS485-	18	5VA	24	RS485+

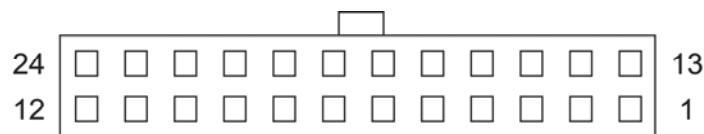

1. REMOTE ON/OFF input is enabled only when HDR22 is set to OFF.



Step 6 - Install Rectifier

Caution: Equipment Damage

Turn AC power OFF to the backplane before installing or removing rectifiers to avoid damage to the rectifier. This backplane does not support hot plug in of rectifiers.

1. Verify AC to backplane is OFF.
2. Slide Rectifier firmly into a Rectifier position - oriented as shown. Assure that the rectifier is fully mated with the backplane connector before applying AC power

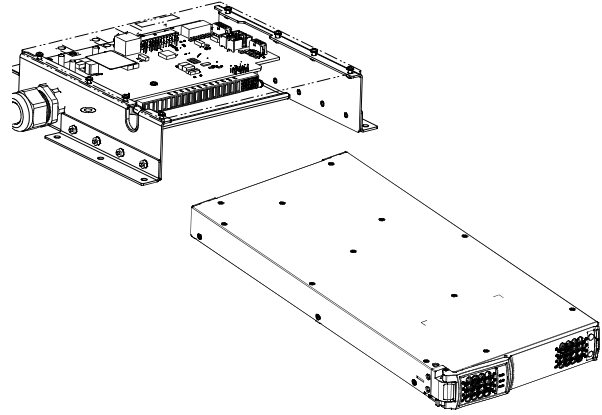

Information pro_GUI Connections

pro_GUI Connections are to HDR1 and HDR2

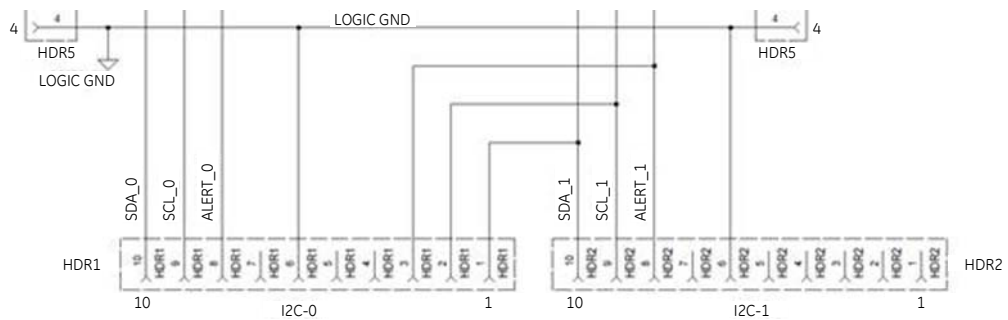

Specifications and Application

- Specifications and engineering information are in the GP100 Global Platform Line High Efficiency Rectifier Data Sheet available at www.gecriticalpower.com
- External Surge Protective Devices (SPDs) - are required on all AC inputs. Equipment Safety is Approved in IEC 60664-1 Installation Category II environments.
- Equipment and subassembly ports: 1. are suitable for connection to intra-building or unexposed wiring or cabling; 2. can be connected to shielded intra-building cabling grounded at both ends.
- Grounding / Bonding Network – Connect to an Isolated Ground Plane (Isolated Bonding Network) or an Integrated Ground Plane (Mesh-Bonding Network or Common Bonding Network).
- Installation Environment - Service Access area only.
- DC return may be either Isolated DC return (DC-I) or Common DC return (DC-C). DC output can either be isolated or either side could be connected to frame ground for reference.

Reference Documents

These documents are available at www.gecriticalpower.com.

Document	Title
GP100	GP100 Global Platform Line High Efficiency Rectifier Data Sheet

Drawings and other engineering information is available - contact Technical Support at 1- 888 546-3243 or PE.TechSupport@ge.com .



Safety Statements

- Do not install this equipment over combustible surfaces.
- Rules and Regulations - Follow all national and local rules and regulations when making field connections.
- Compression Connectors
 - U. S. or Canada installations - use Listed/Certified compression connectors to terminate Listed/Certified field-wire conductors where required.
 - All installations - apply the appropriate connector to the correct size conductor as specified by the connector manufacturer, using only the connector manufacturer's recommended or approved tooling for that connector.
- Electrical Connection Securing: Torque to the values specified on labels or in the product documentation.
- Cable Dress - dress to avoid damage to the conductors and undue stress on the connectors.
- Fuses and Circuit Breakers - Size as required by the National Electric Code (NEC) and/or local codes. Refer to the equipment ratings to assure current does not exceed:
 - Continuous Load (List 1) - 60% of protector rating
 - Maximum Load (List 2 - typically end of discharge) - 80% of protector rating.
- Field-wired Conductors - Follow all National Electric Code (NEC) and local rules and regulations .
 - Size AC field-wired conductors with 75°C ampacity (NEC) equal to or greater than their panel board circuit breaker rating.
 - Insulation rating: 90°C minimum; 105°C (minimum) if internal to enclosed equipment cabinets.
- AC and DC input disconnect/protection - Provide accessible devices to remove input power in an emergency.
- Alarm Signals - Provide external current limiting protection. Rating 60V, 0.5A unless otherwise noted.
- Grounding - Connect the equipment chassis directly to ground. In enclosed equipment cabinets connect to the cabinet ac service ground bus. In huts, vaults, and central offices connect to the system bonding network.
- Circuit Breakers and Fuses - Use only those specified in the equipment ordering guide.
- GMT Style Fuses - Use only fuses provided with safety caps.

Precautions

- Install, service, and operate equipment only by professional, skilled and qualified personnel who have the necessary knowledge and practical experience with electrical equipment and who understand the hazards that can arise when working on this type of equipment.
- Disconnect batteries from outputs and/or follow safety procedures while working on equipment. Batteries may be connected in parallel with the output of the rectifiers. Turning off the rectifiers will not necessarily remove power from the bus.
- Do not disconnect permanent bonding connections unless all power inputs are disconnected.
- Verify that equipment is properly safety earth grounded before connecting power. High leakage currents may be possible.
- Exercise care and follow all safety warnings and practices when servicing this equipment. Hazardous energy and voltages are present in the unit and on the interface cables that can shock or cause serious injury. When equipped with ringer modules, hazardous voltages will be present on the ringer output connectors.
- Use the following precautions in addition to proper job training and safety procedures:
 - Use only properly insulated tools.
 - Remove all metallic objects (key chains, glasses, rings, watches, or other jewelry).
 - Follow Lock Out Tag Out (LOTO) procedures: customer specified, site specific, or general as appropriate. Disconnect all power input before servicing the equipment. Check for multiple power inputs.
 - Wear safety glasses.
 - Follow Personal Protective Equipment requirements: customer specified, site specific, or general as appropriate.
 - Test circuits before touching.
 - Be aware of potential hazards before servicing equipment.
 - Identify exposed hazardous electrical potentials on connectors, wiring, etc.
 - Avoid contacting circuits when removing or replacing covers;.
 - Use a personal ESD strap when accessing or removing electronic components.
- Personnel with electronic medical devices need to be aware that proximity to DC power and distribution systems, including batteries and cables, typically found in telecommunications utility rooms, can affect medical electronic devices, such as pacemakers. Effects decrease with distance.

