



Chipsmall Limited consists of a professional team with an average of over 10 year of expertise in the distribution of electronic components. Based in Hongkong, we have already established firm and mutual-benefit business relationships with customers from,Europe,America and south Asia,supplying obsolete and hard-to-find components to meet their specific needs.

With the principle of “Quality Parts,Customers Priority,Honest Operation,and Considerate Service”,our business mainly focus on the distribution of electronic components. Line cards we deal with include Microchip,ALPS,ROHM,Xilinx,Pulse,ON,Everlight and Freescale. Main products comprise IC,Modules,Potentiometer,IC Socket,Relay,Connector.Our parts cover such applications as commercial,industrial, and automotives areas.

We are looking forward to setting up business relationship with you and hope to provide you with the best service and solution. Let us make a better world for our industry!



Contact us

Tel: +86-755-8981 8866 Fax: +86-755-8427 6832

Email & Skype: info@chipsmall.com Web: www.chipsmall.com

Address: A1208, Overseas Decoration Building, #122 Zhenhua RD., Futian, Shenzhen, China





500 mW Metallurgically Bonded Glass Zener Diodes

Qualified per MIL-PRF-19500/435

*Qualified Levels:
JAN, JANTX,
JANTXV and JANS*

DESCRIPTION

The 1N4099-1 through 1N4135-1 and 1N4614-1 through 1N4627-1 series are 500 mW, Zener voltage regulators in the axial-leaded, glass DO-35 package. Voltages from 1.8 to 100V in 5%, 2%, and 1% tolerances are available. They are constructed with an internal metallurgical bond and are mil-qualified up to the JANS level for high reliability applications.

Important: For the latest information, visit our website <http://www.microsemi.com>.

FEATURES

- JEDEC registered 1N4099 through 1N4135 and 1N4614 through 1N4627 series.
- Internal metallurgical bond.
- Max noise density 40 $\mu\text{V} / \sqrt{\text{Hz}}$ for 6.8 V and up. Falls quickly to 1 $\mu\text{V} / \sqrt{\text{Hz}}$ at lower voltages.
- JAN, JANTX, JANTXV and JANS qualifications are available per MIL-PRF-19500/435.
- RoHS compliant versions available (commercial grade only).

APPLICATIONS / BENEFITS

- Flexible axial-lead mounting terminals.
- Regulates voltage over broad ranges of current and temperature.
- Extensive selection from 1.8 to 100 volts.
- Voltage tolerances of 5% (standard), 2% and 1% are available.
- Hermetically sealed surface mount package.
- Non-sensitive to ESD per MIL-STD-750 method 1020.
- Minimal capacitance (see [Figure 3](#)).
- Inherently radiation hard as described in Microsemi [MicroNote 050](#).

MAXIMUM RATINGS @ $T_C = +25^\circ\text{C}$ unless otherwise specified

| Parameters/Test Conditions | Symbol | Value | Unit |
|---|---------------------|-------------|---------------------------|
| Junction and Storage Temperature | T_J and T_{STG} | -65 to +175 | $^\circ\text{C}$ |
| Thermal Resistance Junction-to-Ambient ⁽¹⁾ | $R_{\theta JA}$ | 300 | $^\circ\text{C}/\text{W}$ |
| Thermal Resistance Junction-to-Lead @ 3/8 (10 mm) lead length from body | $R_{\theta JL}$ | 250 | $^\circ\text{C}/\text{W}$ |
| Rated Average Power Dissipation ⁽²⁾ | $P_{M(AV)}$ | 0.5 | W |
| Forward Voltage @ 200 mA | V_F | 1.1 | V |
| Solder Temperature @ 10 s | | 260 | $^\circ\text{C}$ |

- Notes:**
1. When mounted on FR4 PC board (1 oz Cu) with 4 mm² copper pads and track width 1 mm, length 25 mm.
 2. The 0.5 W should be linearly derated starting at $T_L = 50^\circ\text{C}$ and goes to zero at 175 $^\circ\text{C}$. For ambient T_A condition on a typical PC board, it linearly derates from 500 mW starting at 25 $^\circ\text{C}$ and goes to zero at 175 $^\circ\text{C}$ (see [Figure 2](#)).



DO-35 (DO-204AH) Package

Also available in:

 **DO-213AA package**
(surface mount)
[1N4099UR-1 – 1N4135UR-1](#)
and
[1N4614UR-1 – 1N4627UR-1](#)

 **DO-216 package**
(tabbed surface mount)
[1PMT4099 – 1PMT4135 and](#)
[1PMT4614 – 1PMT4627](#)

MSC – Lawrence
6 Lake Street,
Lawrence, MA 01841
Tel: 1-800-446-1158 or
(978) 620-2600
Fax: (978) 689-0803

MSC – Ireland
Gort Road Business Park,
Ennis, Co. Clare, Ireland
Tel: +353 (0) 65 6840044
Fax: +353 (0) 65 6822298

Website:
www.microsemi.com

MECHANICAL and PACKAGING

- CASE: Hermetically sealed axial-lead glass DO-35 (DO-204AH) style package.
- TERMINALS: Tin-lead or RoHS compliant annealed matte-tin (on commercial grade only) plating. Solderable per MIL-STD-750, method 2026.
- POLARITY: Cathode indicated by band. The diode is to be operated with the banded end positive with respect to the opposite end for Zener regulation.
- MARKING: Part number.
- TAPE & REEL option: Standard per EIA-296 (add "TR" suffix to part number). Consult factory for quantities.
- WEIGHT: Approximately 0.2 grams.
- See [Package Dimensions](#) on last page.

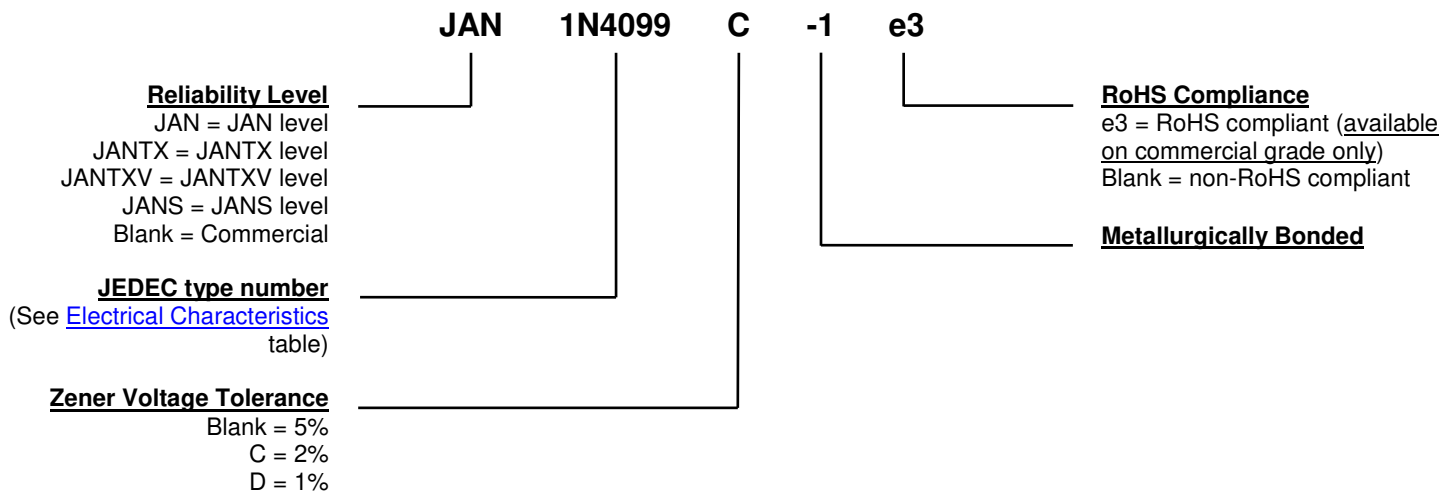
PART NOMENCLATURE

SYMBOLS & DEFINITIONS

| Symbol | Definition |
|-----------------------|---|
| α_{VZ} | Temperature Coefficient of Regulator Voltage: The change in regulator voltage divided by the change in temperature that caused it expressed in %/C or mV/°C. |
| I_R | Reverse Current: The maximum reverse (leakage) current that will flow at the specified voltage and temperature. |
| I_Z, I_{ZT}, I_{ZK} | Regulator Current: The dc regulator current (I_Z), at a specified test point (I_{ZT}), near breakdown knee (I_{ZK}). |
| I_{ZM} | Maximum Regulator (Zener) Current: The maximum rated dc current for the specified power rating. |
| N_D | Noise Density: The noise generated over a specified frequency bandwidth usually specified in terms of mV/ $\sqrt{\text{Hz}}$. |
| V_R | Reverse Voltage: The reverse voltage dc value, no alternating component. |
| V_Z | Zener Voltage: The Zener voltage the device will exhibit at a specified current (I_Z) in its breakdown region. |
| Z_{ZT} or Z_{ZK} | Dynamic Impedance: The small signal impedance of the diode when biased to operate in its breakdown region at a specified rms current modulation (typically 10% of I_{ZT} or I_{ZK}) and superimposed on I_{ZT} or I_{ZK} respectively. |

ELECTRICAL CHARACTERISTICS @ 25 °C unless otherwise stated

| INDUSTRY PART NUMBER* (Note 1) | NOMINAL ZENER VOLTAGE $V_Z @ I_{ZT}$ (Note 2) | ZENER TEST CURRENT I_{ZT} | MAXIMUM ZENER IMPEDANCE Z_{ZT} (Note 3) | MAXIMUM REVERSE CURRENT $I_R @ V_R$ | | MAXIMUM NOISE DENSITY $N_D @ I_{ZT}$ | MAXIMUM ZENER CURRENT I_{ZM} | MAXIMUM TEMP. COEFF. OF ZENER VOLTAGE α_{VZ} |
|---|---|--------------------------------------|---|--|-------|---|---|---|
| | Volts | μA | Ohms | μA | Volts | $\mu V/\sqrt{Hz}$ | mA | %/°C |
| 1N4614-1 | 1.8 | 250 | 1200 | 3.5 | 1.0 | 1 | 120.0 | -0.075 |
| 1N4615-1 | 2.0 | 250 | 1250 | 2.5 | 1.0 | 1 | 110.0 | -0.075 |
| 1N4616-1 | 2.2 | 250 | 1300 | 2.0 | 1.0 | 1 | 100.0 | -0.075 |
| 1N4617-1 | 2.4 | 250 | 1400 | 1.0 | 1.0 | 1 | 95.0 | -0.075 |
| 1N4618-1 | 2.7 | 250 | 1500 | 0.5 | 1.0 | 1 | 90.0 | -0.075 |
| 1N4619-1 | 3.0 | 250 | 1600 | 0.4 | 1.0 | 1 | 87.0 | -0.075 |
| 1N4620-1 | 3.3 | 250 | 1650 | 3.5 | 1.5 | 1 | 85.0 | -0.075 |
| 1N4621-1 | 3.6 | 250 | 1700 | 3.5 | 2.0 | 1 | 83.0 | -0.065 |
| 1N4622-1 | 3.9 | 250 | 1650 | 2.5 | 2.0 | 1 | 80.0 | -0.060 |
| 1N4623-1 | 4.3 | 250 | 1600 | 2.0 | 2.0 | 1 | 77.0 | -0.050 |
| 1N4624-1 | 4.7 | 250 | 1550 | 5.0 | 3.0 | 1 | 75.0 | -0.050,+0.020 |
| 1N4625-1 | 5.1 | 250 | 1500 | 5.0 | 3.0 | 2 | 70.0 | -0.045,+0.030 |
| 1N4626-1 | 5.6 | 250 | 1400 | 5.0 | 4.0 | 4 | 65.0 | -0.020,+0.040 |
| 1N4627-1 | 6.2 | 250 | 1200 | 5.0 | 5.0 | 5 | 61.0 | -0.010,+0.050 |
| 1N4099-1 | 6.8 | 250 | 200 | 1.0 | 5.2 | 40 | 56.0 | +0.060 |
| 1N4100-1 | 7.5 | 250 | 200 | 1.0 | 5.7 | 40 | 51.0 | +0.065 |
| 1N4101-1 | 8.2 | 250 | 200 | 0.5 | 6.3 | 40 | 46.0 | +0.070 |
| 1N4102-1 | 8.7 | 250 | 200 | 0.5 | 6.7 | 40 | 44.0 | +0.075 |
| 1N4103-1 | 9.1 | 250 | 200 | 0.5 | 7.0 | 40 | 42.0 | +0.080 |
| 1N4104-1 | 10.0 | 250 | 200 | 0.5 | 7.6 | 40 | 38.0 | +0.080 |
| 1N4105-1 | 11.0 | 250 | 200 | 0.05 | 8.5 | 40 | 35.0 | +0.080 |
| 1N4106-1 | 12.0 | 250 | 200 | 0.05 | 9.2 | 40 | 32.0 | +0.080 |
| 1N4107-1 | 13.0 | 250 | 200 | 0.05 | 9.9 | 40 | 29.0 | +0.080 |
| 1N4108-1 | 14.0 | 250 | 200 | 0.05 | 10.7 | 40 | 27.0 | +0.085 |
| 1N4109-1 | 15.0 | 250 | 100 | 0.05 | 11.4 | 40 | 25.0 | +0.085 |
| 1N4110-1 | 16.0 | 250 | 100 | 0.05 | 12.2 | 40 | 24.0 | +0.085 |
| 1N4111-1 | 17.0 | 250 | 100 | 0.05 | 13.0 | 40 | 22.0 | +0.090 |
| 1N4112-1 | 18.0 | 250 | 100 | 0.05 | 13.7 | 40 | 21.0 | +0.090 |
| 1N4113-1 | 19.0 | 250 | 150 | 0.05 | 14.5 | 40 | 20.0 | +0.090 |
| 1N4114-1 | 20.0 | 250 | 150 | 0.01 | 15.2 | 40 | 19.0 | +0.090 |
| 1N4115-1 | 22.0 | 250 | 150 | 0.01 | 16.8 | 40 | 17.0 | +0.090 |
| 1N4116-1 | 24.0 | 250 | 150 | 0.01 | 18.3 | 40 | 16.0 | +0.090 |
| 1N4117-1 | 25.0 | 250 | 150 | 0.01 | 19.0 | 40 | 15.0 | +0.090 |
| 1N4118-1 | 27.0 | 250 | 150 | 0.01 | 20.5 | 40 | 14.0 | +0.090 |
| 1N4119-1 | 28.0 | 250 | 200 | 0.01 | 21.3 | 40 | 14.0 | +0.095 |
| 1N4120-1 | 30.0 | 250 | 200 | 0.01 | 22.8 | 40 | 13.0 | +0.095 |
| 1N4121-1 | 33.0 | 250 | 200 | 0.01 | 25.1 | 40 | 12.0 | +0.095 |
| 1N4122-1 | 36.0 | 250 | 200 | 0.01 | 27.4 | 40 | 11.0 | +0.095 |
| 1N4123-1 | 39.0 | 250 | 200 | 0.01 | 29.7 | 40 | 9.8 | +0.095 |
| 1N4124-1 | 43.0 | 250 | 250 | 0.01 | 32.7 | 40 | 8.9 | +0.095 |
| 1N4125-1 | 47.0 | 250 | 250 | 0.01 | 35.8 | 40 | 8.1 | +0.095 |
| 1N4126-1 | 51.0 | 250 | 300 | 0.01 | 38.8 | 40 | 7.5 | +0.100 |
| 1N4127-1 | 56.0 | 250 | 300 | 0.01 | 42.6 | 40 | 6.7 | +0.100 |
| 1N4128-1 | 60.0 | 250 | 400 | 0.01 | 45.6 | 40 | 6.4 | +0.100 |
| 1N4129-1 | 62.0 | 250 | 500 | 0.01 | 47.1 | 40 | 6.1 | +0.100 |
| 1N4130-1 | 68.0 | 250 | 700 | 0.01 | 51.7 | 40 | 5.6 | +0.100 |
| 1N4131-1 | 75.0 | 250 | 700 | 0.01 | 57.0 | 40 | 5.1 | +0.100 |
| 1N4132-1 | 82.0 | 250 | 800 | 0.01 | 62.4 | 40 | 4.6 | +0.100 |
| 1N4133-1 | 87.0 | 250 | 1000 | 0.01 | 66.2 | 40 | 4.4 | +0.100 |
| 1N4134-1 | 91.0 | 250 | 1200 | 0.01 | 69.2 | 40 | 4.2 | +0.100 |
| 1N4135-1 | 100.0 | 250 | 1600 | 0.01 | 76.0 | 40 | 3.8 | +0.100 |

*JEDEC Registered Data.

SEE NOTES ON NEXT PAGE.

- NOTE 1:** The JEDEC type numbers shown in the prior table have a standard tolerance of +/-5% on the nominal Zener voltage. V_Z is measured with the diode in thermal equilibrium (still air) at 25 °C.
- NOTE 2:** Zener impedance is derived by superimposing on I_{ZT} a 60 Hz rms ac current at 10% of I_{ZT} (25 μ A). See [MicroNote 202](#) for Zener impedance variation with different operating currents.
- NOTE 3:** Based upon 400 mW maximum power dissipation at 25 °C lead temperature, allowance has been made for the higher voltage associated with operation at higher currents.

GRAPHS

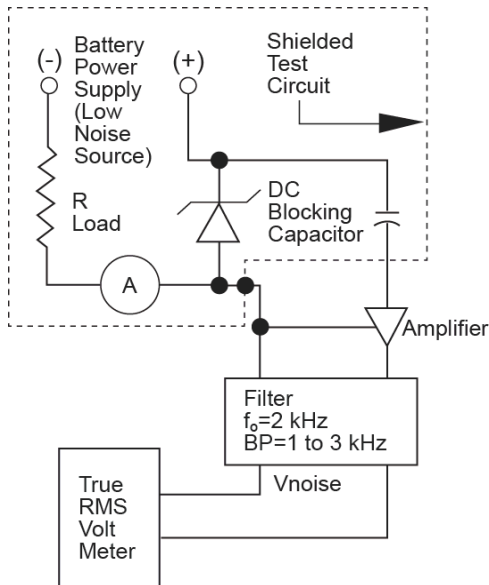

FIGURE 1 – Noise Density Measurement Circuit

Noise density, (N_D) is specified in microvolt-rms per square-root-hertz. Actual measurement is performed using a 1 KHz to 3 KHz frequency bandpass filter at a constant Zener test current (I_{ZT}) at 25 °C ambient temperature. N_D is calculated from the formula.

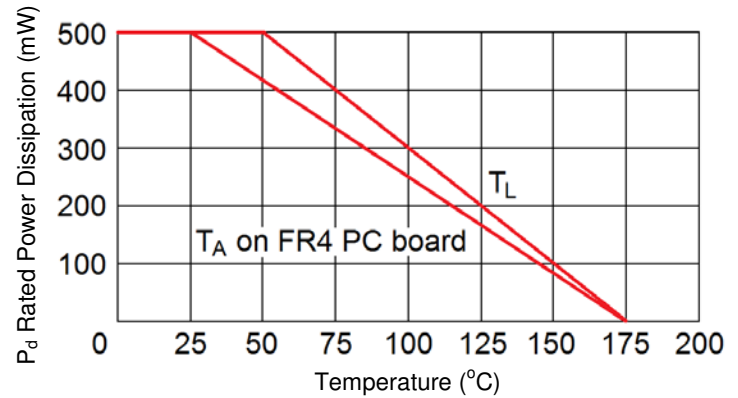

FIGURE 2 – Power Derating Curve

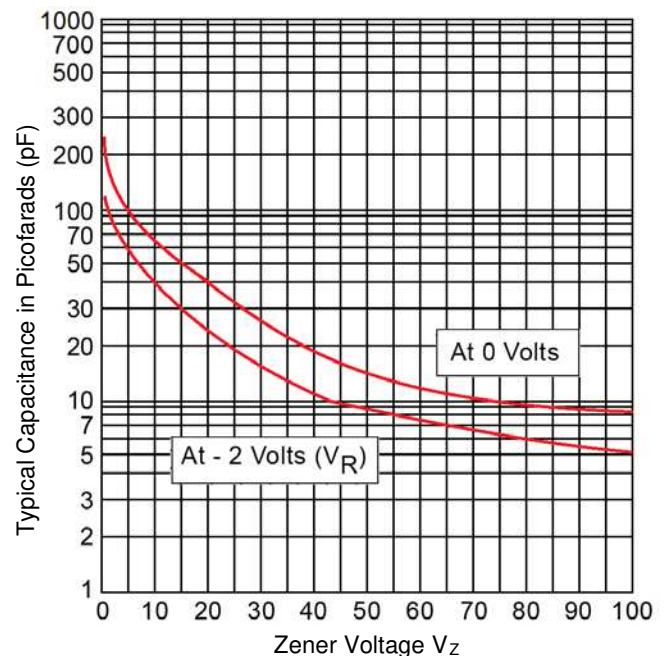
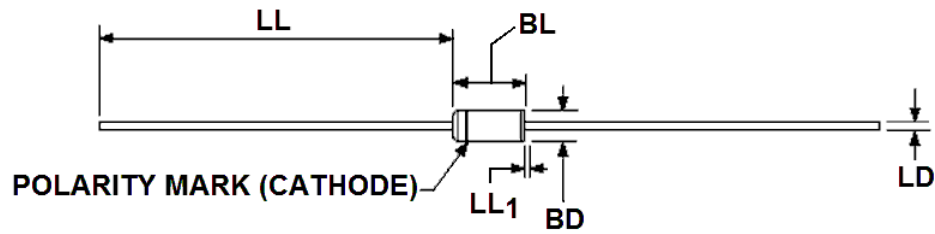

FIGURE 3 – Capacitance vs. Zener Voltage (Typical)

PACKAGE DIMENSIONS

| Ltr | Dimensions | | | | Notes |
|-----------------------|------------|-------|-------------|-------|-------|
| | Inches | | Millimeters | | |
| | Min | Max | Min | Max | |
| BD | 0.056 | 0.090 | 1.42 | 2.29 | 3 |
| BL | 0.140 | 0.200 | 3.56 | 5.08 | 3 |
| LD | 0.018 | 0.022 | 0.46 | 0.56 | |
| LL | 1.000 | 1.500 | 25.40 | 38.10 | |
| LL₁ | - | 0.050 | - | 1.27 | 4 |

NOTES:

1. Dimensions are in inches.
2. Millimeters are given for information only.
3. Package contour optional within BD and length BL. Heat slugs, if any, shall be included within this cylinder but shall not be subject to minimum limit of BD. The BL dimension shall include the entire body including slugs.
4. Within this zone lead, diameter may vary to allow for lead finishes and irregularities other than heat slugs.
5. In accordance with ASME Y14.5M, diameters are equivalent to Φ x symbology.