



Chipsmall Limited consists of a professional team with an average of over 10 year of expertise in the distribution of electronic components. Based in Hongkong, we have already established firm and mutual-benefit business relationships with customers from,Europe,America and south Asia,supplying obsolete and hard-to-find components to meet their specific needs.

With the principle of “Quality Parts,Customers Priority,Honest Operation,and Considerate Service”,our business mainly focus on the distribution of electronic components. Line cards we deal with include Microchip,ALPS,ROHM,Xilinx,Pulse,ON,Everlight and Freescale. Main products comprise IC,Modules,Potentiometer,IC Socket,Relay,Connector.Our parts cover such applications as commercial,industrial, and automotives areas.

We are looking forward to setting up business relationship with you and hope to provide you with the best service and solution. Let us make a better world for our industry!



Contact us

Tel: +86-755-8981 8866 Fax: +86-755-8427 6832

Email & Skype: info@chipsmall.com Web: www.chipsmall.com







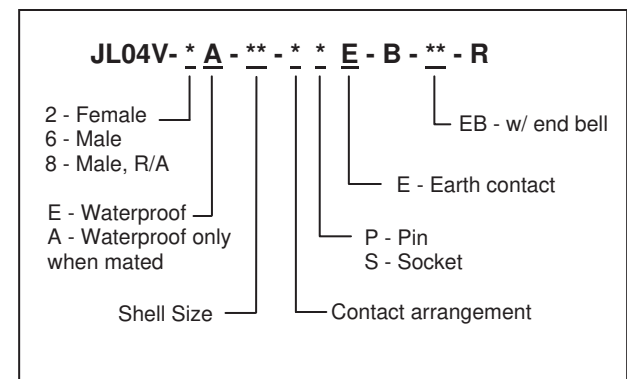
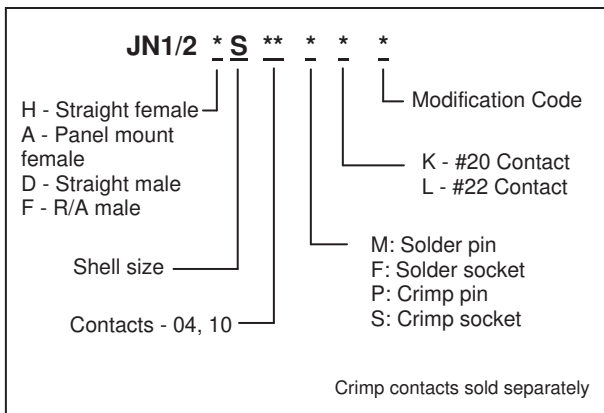
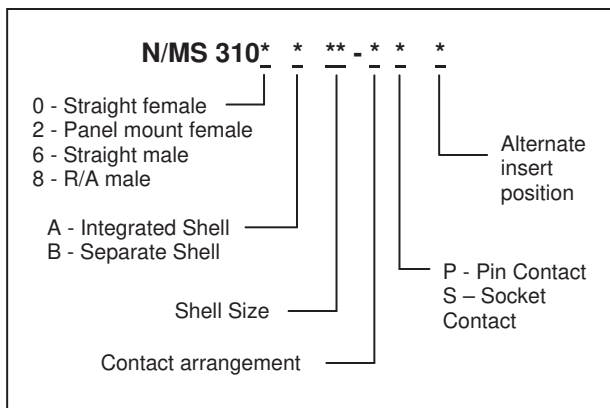
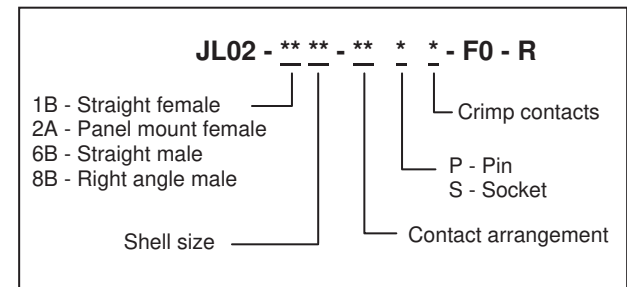
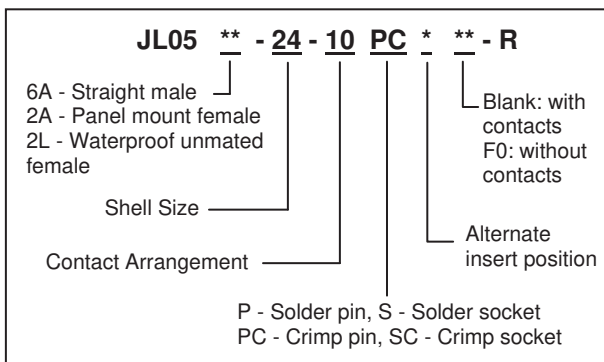
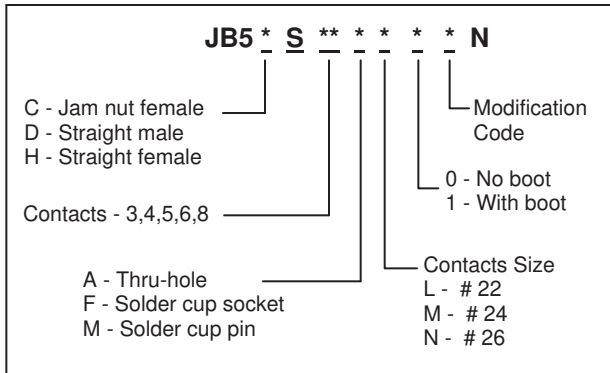
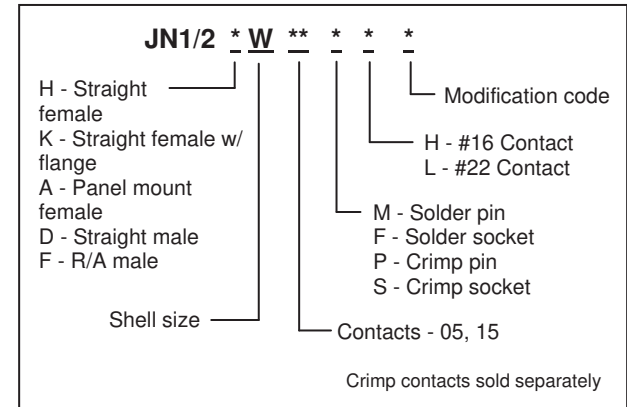
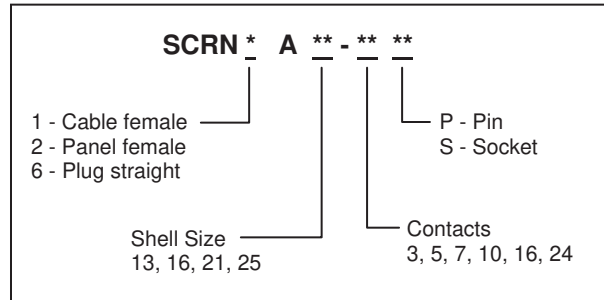
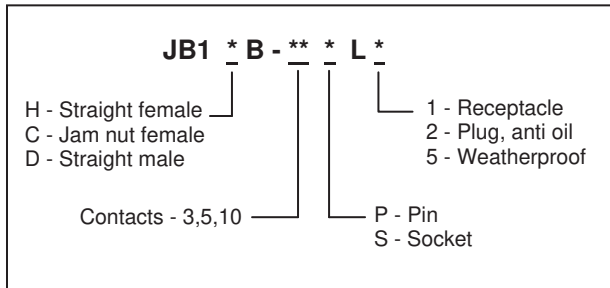

Address: A1208, Overseas Decoration Building, #122 Zhenhua RD., Futian, Shenzhen, China





Circular Connectors



Series	JB5	JB1	JN1 / JN2	JN1W / JN2W	SRCN	JL02	JL04V	JL05	N/MS
Photo									
Shell Size	Φ11.0mm	Φ18.0mm	Φ19.0mm	Φ26.2mm	Φ21.2-33.2mm	Φ34-62.7mm	Φ22-56.3mm	Φ36-51.7mm	Φ20-77mm
Pin Count	3, 4, 5, 6, 8	3, 5, 10	4, 10	5, 15	3, 5, 7, 10, 16, 24	10, 17, 19, 24, 37, 48, 54	3, 4, 6, 7, 8, 9, 18, 22	4,5,7,8,9,10, 17,19,24,30, 36,37,52,73	1~11,14,16,17, 19,22,24,26,35, 37,48,54
Shell Material	Metal	Metal	JN1: Plastic JN2: Metal	JN1W: Plastic JN2W: Metal	Metal	Metal	Metal	Metal	Metal
Mated Condition	IP68	IP67	IP67	IP67	N/A	N/A	IP67	IP67	N/A
Current Rating	2 ~ 3A	3A	3 ~ 5A	3 ~ 13A	5 ~ 10A	1.5 ~ 3.0A	13 ~ 80A	5 ~ 46A	13 ~ 150A
Voltage Rating	200VAC ~ 320VAC	300VAC	200VAC	200VAC ~ 400VAC	250VAC / 350VDC	200VAC ~ 500VAC	100VAC ~ 500VAC	250VAC ~ 900VAC	200VAC ~ 3,000VAC
Durability	5,000 cycles	500 cycles	500 cycles	500 cycles	500 cycles	500 cycles	500 cycles	500 cycles	500 cycles
Lock	Push-pull	Threaded	Push and twist	Push and twist	Screw	Threaded	Threaded	Bayonet	Threaded
Operating Temp	-55 ~ +85 °C	-30 ~ +85 °C	-20 ~ +125 °C	-20 ~ +125 °C	-25 ~ +85 °C	-55 ~ +85 °C	-55 ~ +125 °C	-55 ~ +125 °C	-55 ~ +125 °C
Wire Size	AWG #22-28	AWG #22-28	AWG #20-28	AWG #14-28	AWG #16-20	AWG #4-16	AWG #4-18	AWG #8-26	AWG #0-16
Termination	Solder	Crimp	Crimp / Solder	Crimp / Solder	Solder	Crimp	Solder	Crimp / Solder	Solder
Features	Small size. Unmated waterproof.	EMI Shielding	One-touch locking mechanism	One-touch locking mechanism	UL approved. 5 insert guide keys.	Mates with MIL-C-5015 standard.	TUV and UL approved	JIS B 6015 compatible.	UL approved. Mates with MIL-C-5015 standard.