



Chipsmall Limited consists of a professional team with an average of over 10 year of expertise in the distribution of electronic components. Based in Hongkong, we have already established firm and mutual-benefit business relationships with customers from,Europe,America and south Asia,supplying obsolete and hard-to-find components to meet their specific needs.

With the principle of “Quality Parts,Customers Priority,Honest Operation,and Considerate Service”,our business mainly focus on the distribution of electronic components. Line cards we deal with include Microchip,ALPS,ROHM,Xilinx,Pulse,ON,Everlight and Freescale. Main products comprise IC,Modules,Potentiometer,IC Socket,Relay,Connector.Our parts cover such applications as commercial,industrial, and automotives areas.

We are looking forward to setting up business relationship with you and hope to provide you with the best service and solution. Let us make a better world for our industry!



## Contact us

Tel: +86-755-8981 8866 Fax: +86-755-8427 6832

Email & Skype: info@chipsmall.com Web: www.chipsmall.com

Address: A1208, Overseas Decoration Building, #122 Zhenhua RD., Futian, Shenzhen, China



# HRS-Original Multi-purpose High-pin-count Miniature Waterproof Connectors

## RM-W Series



### Overview

RM-W series connectors originally developed by Hirose offer miniature waterproof connectors to satisfy the requirements of high-capability in a small package. The locking structure adopts a thread coupling style, showing superior waterproof reliability.

### Features

#### 1. Rich variation

In RM-W series, you can select an optimal product for your application through different kinds of both plugs and receptacles.

Plugs :

Available in 3 types - straight plug, straight low-height plug, and right-angled plug.

Receptacles :

Single-body waterproof type is available to satisfy waterproof requirements in a single connector.

Fixing methods :

Available in 2 types-Jam nut type and screw tightening type with square flange. The Jam nut types offer a front or back mount application.

Available numbers of contacts :

2, 3, 4, 8, 10, 12, 15, 20, 40, and 55 contacts in 2 contact plating types: gold or silver.

#### 2. Waterproof structure

When fully mated, the connectors meet the waterproof requirements of IP67 and IP68. Single-body waterproof receptacles also meet the requirements of IP67 and IP68.

\*IP67 : Submerged in 1m for 30 minutes.

\*IP68 : Submerged in 2m for 14 days.

#### 3. Flexible cable arrangements

The assembly type right-angled plugs permit exiting of the cable over a 360-degree range in any direction.

#### Assembly type (straight plug/RM15W)

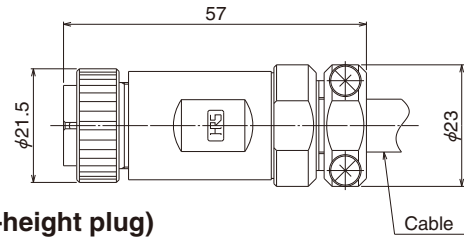

#### (Low-height plug)

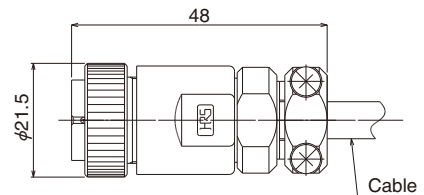
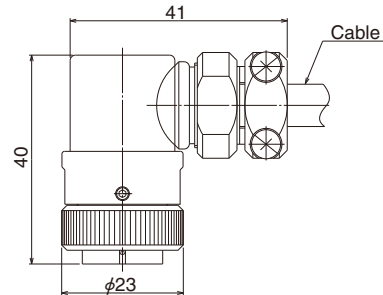

Fig.1

#### Assembly type (right-angled plug/RM15W)



Flexible cable arrangements

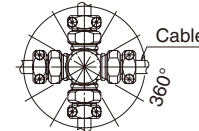

Fig.2

## ■ Product Specifications (RM15WT size products)

Rating	Voltage rating	600V AC, 840V DC (2 pos.) 500V AC, 700V DC (3, 4, 8 pos.) 350V AC, 490V DC (10 pos.) 350V AC, 490V DC (12 pos.)
	Current rating	10A (2, 3, 4 pos.) 5A (8, 10, 12 pos.)
	Operating temperature range (Note 1)	-25°C to +85°C
	Storage temperature range (Note 2)	-10°C to +60°C

Characteristic	Specification	Conditions
1. Contact resistance	2mΩ max.(2, 3, 4 pos.) 4mΩ max.(8, 10, 12 pos.)	1A DC
2. Insulation resistance	1,000MΩ min	500V DC
3. Withstanding voltage	No flashover or insulation breakdown.	1,800V AC/one minute (2 pos.) 2,000V AC/one minute (3 pos.) 1,500V AC/one minute (4, 8 pos.) 1,000V AC/one minute (10, 12 pos.)
4. Vibration	No electrical discontinuity for 10μs max.	Frequency : 10 to 55Hz, single amplitude of 0.75mm, for 3 hours in 3 axis.
5. Shock	No electrical discontinuity for 10μs max.	Acceleration of 490m/s <sup>2</sup> , 11ms duration, sine half-wave waveform, 3 cycles in each of the 3 axis.
6. Durability (insertion/withdrawal)	4mΩ max.(2, 3, 4 pos.) 8mΩ max.(8, 10, 12 pos.)	2,000 cycles
7. Temperature cycle	Insulation resistance : 100MΩ min.	Temperature : -55°C → Room temperature → +85°C → Room temperature Time : 30 → 10 to 15 → 30 → 10 to 15 (Minutes) 5 cycles
8. Humidity	Insulation resistance : 100MΩ min.(Dry state)	96 hours at temperature of 40°C and humidity of 90% to 95%.
9. Water / dust protection	When mated with corresponding connector.	Complete dust protection. No water penetration when submerged for 48 hours at the depth of 1.8 meter.

Note 1 : Includes temperature rise caused by the current flow.

Note 2 : The term "storage" refers to products stored for long period of time prior to mounting and use. Operating temperature range and humidity range covers non-conducting condition of installed connectors in storage, shipment or during transportation.

## ■ Materials / Finish

Item	Material	Finish	Remarks
Body	Zinc alloy, brass	Chrome plated or nickel plated	—————
Insulator	Diallyl phthalate resin	—————	UL94V-0 (Color : Black)
Contacts	Brass, phosphor bronze, or copper alloy	Silver plated or gold plated	—————
Packing	SIR (black or red), or NBR (gray)	—————	—————

Note : Do not mix different contact plating.

## ■ Product Number Structure

Refer to the chart below when determining the product specifications from the product number.

Please select from the product numbers listed in this catalog when placing orders.

**RM 15 W T P\*\* - 2 P (\*\*)**

①    ②    ① ③    ④    ⑤ ⑥    ⑦

① Series name : RM-W	⑤ Number of Contacts
② Shell size	⑥ Contact type P : Male contact S : Female contact
③ Lock type T : Screw Lock	
④ Connector type P : Plug LP : Plug(right angle) R : Receptacle	⑦ Plating (71) : Silver plated (72) : Gold plated

## Plugs - Straight Long Back Shell

### RM15WTPZA-10S(71)

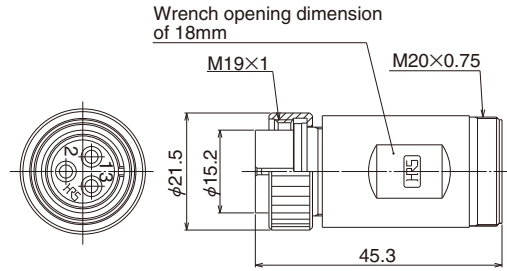

(Representative example)

[Specification number] (\*\*), -\*\*  
 (71) : Silver plated contacts  
 (72) : Gold plated contacts

Part No.	HRS No.	No. of contacts	Weight
RM15WTPZA-2P(**)	109-1734-5 **	2	43g
RM15WTPZA-3P(72)	109-1602-4 72	3	45g
RM15WTPZA-4P(**)	109-1735-8 **	4	44g
RM15WTPZA-8P(**)	109-1736-0 **	8	43g
RM15WTPZA-10P(**)	109-1737-3 **	10	44g
RM15WTPZA-12P(**)	109-1738-6 **	12	

Part No.	HRS No.	No. of contacts	Weight
RM15WTPZA-2S(**)	109-1729-5 **	2	45g
RM15WTPZA-3S(**)	109-1601-1 **	3	47g
RM15WTPZA-8S(**)	109-1731-7 **	8	45g
RM15WTPZA-10S(**)	109-1732-0 **	10	
RM15WTPZA-12S(**)	109-1733-2 **	12	

## Applicable Strain Reliefs

### External cable clamp + internal, self-tightening

#### JR16WCC-10(72)

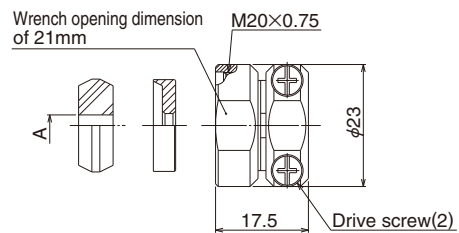
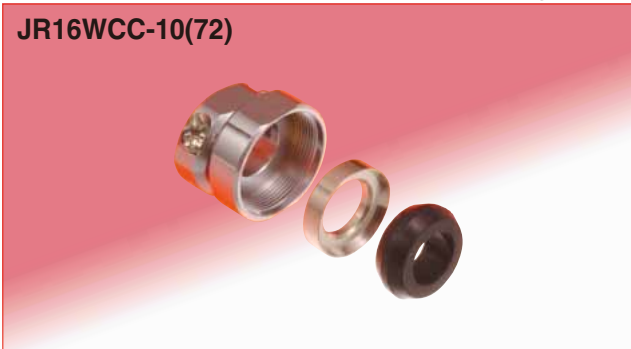

(Representative example)

Part No.	HRS No.	A	Weight
JR16WCC-4(72)	114-2052-6 72	4	17.5g
JR16WCC-6(72)	114-2053-9 72	6	
JR16WCC-8(72)	114-2054-1 72	8	

Part No.	HRS No.	A	Weight
JR16WCC-10(72)	114-2055-4 72	10	17.5g
JR16WCC-11(72)	114-2154-6 72	11	
JR16WCC-12(72)	114-2056-7 72	12	

### Internal, self tightening

#### JR16WCCA-10(72)

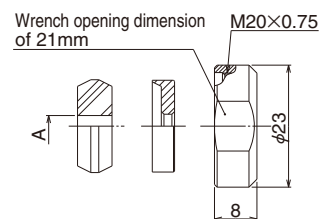

(Representative example)

Part No.	HRS No.	A	Weight
JR16WCCA-4(72)	114-2076-4 72	4	16g
JR16WCCA-6(72)	114-2077-7 72	6	
JR16WCCA-8(72)	114-2078-0 72	8	

Part No.	HRS No.	A	Weight
JR16WCCA-10(72)	114-2079-2 72	10	16g
JR16WCCA-11(72)	114-2155-9 72	11	
JR16WCCA-12(72)	114-2080-1 72	12	

Note 1 : Cable jacket diameter : Use  $A \pm 0.2\text{mm}$

Note 2 : When using the self-tightening strain relief verify the cable pull force requirements.

## ■ Plugs - Straight Short Back Shell

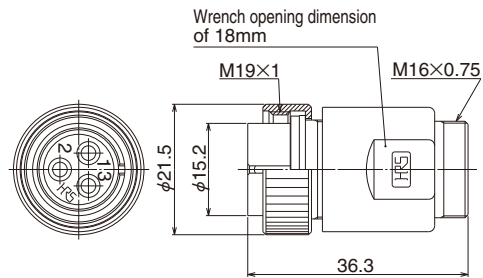

(Representative example)

[Specification number] (\*\*), -\*\*  
 (71) : Silver plated contacts  
 (72) : Gold plated contacts

Part No.	HRS No.	No. of contacts	Weight
RM15WTPZ-2P(**)	109-1616-9 **	2	32g
RM15WTPZ-3P(**)	109-1622-1 **	3	34g
RM15WTPZ-4P(**)	109-1617-1 **	4	33g
RM15WTPZ-8P(**)	109-1618-4 **	8	32g
RM15WTPZ-10P(**)	109-1619-7 **	10	33g
RM15WTPZ-12P(**)	109-1620-6 **	12	

Part No.	HRS No.	No. of contacts	Weight
RM15WTPZ-2S(**)	109-1611-5 **	2	34g
RM15WTPZ-3S(**)	109-1621-9 **	3	36g
RM15WTPZ-8S(**)	109-1613-0 **	8	34g
RM15WTPZ-10S(**)	109-1614-3 **	10	
RM15WTPZ-12S(**)	109-1615-6 **	12	

## ■ Applicable Strain Reliefs

### ● External cable clamp + internal, self-tightening

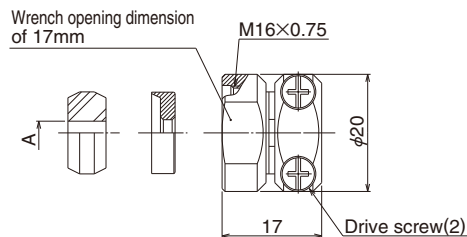

(Representative example)

Part No.	HRS No.	A	Weight
JR13WCC-4(72)	114-2045-0 72	4	17g
JR13WCC-5(72)	114-2046-3 72	5	
JR13WCC-6(72)	114-2047-6 72	6	

Part No.	HRS No.	A	Weight
JR13WCC-7(72)	114-2048-9 72	7	17g
JR13WCC-8(72)	114-2049-1 72	8	
JR13WCC-9(72)	114-2050-0 72	9	
JR13WCC-10(72)	114-2051-3 72	10	

### ● Internal, self tightening

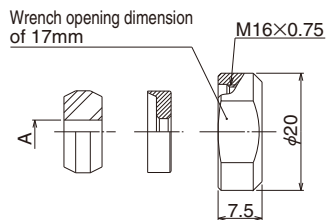

(Representative example)

Part No.	HRS No.	A	Weight
JR13WCCA-4(72)	114-2069-9 72	4	12g
JR13WCCA-5(72)	114-2070-8 72	5	
JR13WCCA-6(72)	114-2071-0 72	6	

Part No.	HRS No.	A	Weight
JR13WCCA-7(72)	114-2072-3 72	7	12g
JR13WCCA-8(72)	114-2073-6 72	8	
JR13WCCA-9(72)	114-2074-9 72	9	
JR13WCCA-10(72)	114-2075-1 72	10	

Note 1 : Cable jacket diameter : Use A ± 0.2mm

Note 2 : When using the self-tightening strain relief verify the cable pull force requirements.

Apr. 1. 2017 Copyright 2017 HIROSE ELECTRIC CO., LTD. All Rights Reserved.

## ■ Plugs - Right Angle

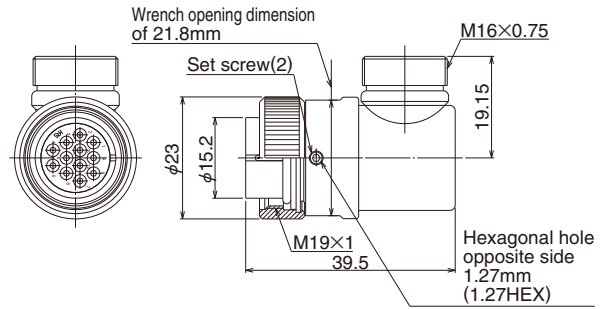

(Representative example)

Part No.	HRS No.	No. of contacts	Weight
RM15WTLP-4P(71)	109-1886-3 71	4	60.6g
RM15WTLP-8P(71)	109-1887-6 71	8	61.5g
RM15WTLP-8S(72)	109-1889-1 72	8	63.2g

Note 1 : Packing material : NBR, body plating : nickel  
 Note 2 : HRS recommended tool : 1.27mm Hex Wrench  
 Note 3 : Recommended set screw tightening torque : 0.2 to 0.3N·m.

Part No.	HRS No.	No. of contacts	Weight
RM15WTLP-10P(71)	109-0020-0 71	10	62.1g
RM15WTLP-10S(71)	109-0999-4 71	10	63.1g
RM15WTLP-12P(71)	109-0997-9 71	12	62.3g
RM15WTLP-12S(71)	109-1991-9 71		64.3g

## ■ Applicable Strain Reliefs

### ● External cable clamp + internal, self-tightening

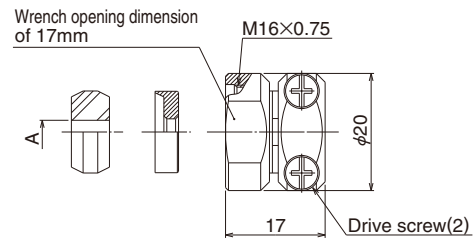

(Representative example)

Part No.	HRS No.	A	Weight
JR13WCC-4(72)	114-2045-0 72	4	17g
JR13WCC-5(72)	114-2046-3 72	5	
JR13WCC-6(72)	114-2047-6 72	6	

Part No.	HRS No.	A	Weight
JR13WCC-7(72)	114-2048-9 72	7	17g
JR13WCC-8(72)	114-2049-1 72	8	
JR13WCC-9(72)	114-2050-0 72	9	
JR13WCC-10(72)	114-2051-3 72	10	

### ● Internal, self tightening

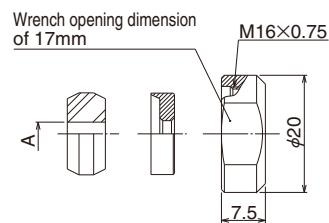

(Representative example)

Part No.	HRS No.	A	Weight
JR13WCCA-4(72)	114-2069-9 72	4	12g
JR13WCCA-5(72)	114-2070-8 72	5	
JR13WCCA-6(72)	114-2071-0 72	6	

Part No.	HRS No.	A	Weight
JR13WCCA-7(72)	114-2072-3 72	7	12g
JR13WCCA-8(72)	114-2073-6 72	8	
JR13WCCA-9(72)	114-2074-9 72	9	
JR13WCCA-10(72)	114-2075-1 72	10	

Note 1 : Cable jacket diameter : Use  $A \pm 0.2\text{mm}$   
 Note 2 : When using the self-tightening strain relief verify the cable pull force requirements.

## ■ Receptacles

### ● Front panel mount

RM15WTRZ-10S(71)

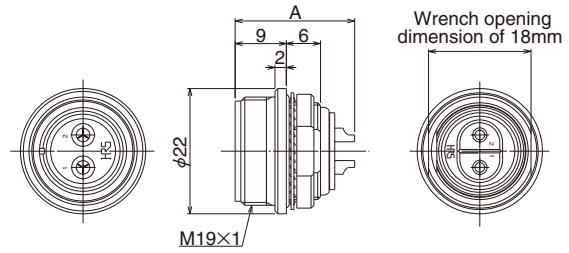
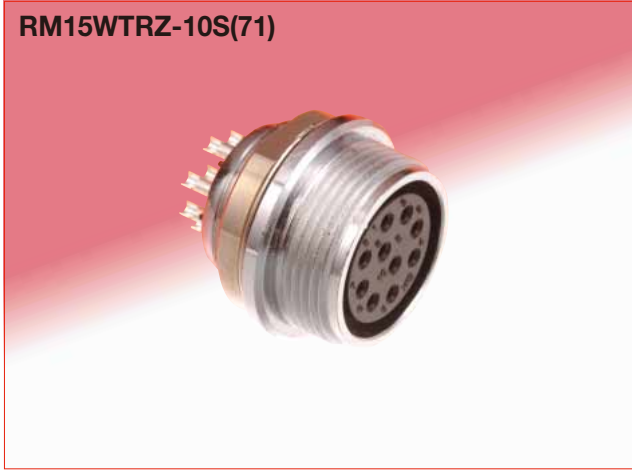

(Representative example)

[Specification number] (\*\*), -\*\*  
 (71) : Silver plated contacts  
 (72) : Gold plated contacts

Part No.	HRS No.	No. of contacts	A	Weight
RM15WTRZ-2P(**)	109-1631-2 **	2	21	13g
RM15WTRZ-3P(**)	109-1632-5 **	3	22.1	15g
RM15WTRZ-4P(**)	109-1633-8 **	4	21	14g
RM15WTRZ-8P(**)	109-1634-0 **	8	20.65	13g
RM15WTRZ-10P(**)	109-1635-3 **	10		14g
RM15WTRZ-12P(**)	109-1636-6 **	12		

Note : Recommended nut tightening torque : 3N·m

Part No.	HRS No.	No. of contacts	A	Weight
RM15WTRZ-2S(**)	109-1637-9 **	2	21.75	15g
RM15WTRZ-3S(**)	109-1638-1 **	3	22.1	17g
RM15WTRZ-8S(**)	109-1640-3 **	8	21.6	15g
RM15WTRZ-10S(**)	109-1641-6 **	10		
RM15WTRZ-12S(**)	109-1642-9 **	12		

### ● Rear panel mount

RM15WTRZA-10S(71)

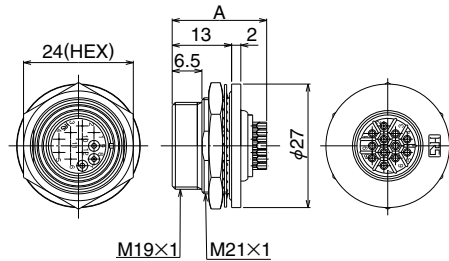
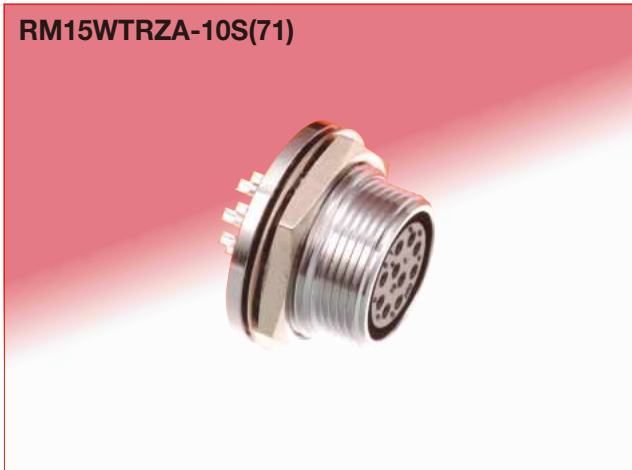

(Representative example)

[Specification number] (\*\*), -\*\*  
 (71) : Silver plated contacts  
 (72) : Gold plated contacts

Part No.	HRS No.	No. of contacts	A	Weight
RM15WTRZA-2P(**)	109-1651-0 **	2	21	22g
RM15WTRZA-3P(**)	109-1652-2 **	3	22.1	24g
RM15WTRZA-4P(**)	109-1653-5 **	4	21	23g
RM15WTRZA-8P(**)	109-1654-8 **	8	20.65	22g
RM15WTRZA-10P(**)	109-1655-0 **	10		23g
RM15WTRZA-12P(**)	109-1656-3 **	12		

Note : Recommended nut tightening torque : 3N·m

Part No.	HRS No.	No. of contacts	A	Weight
RM15WTRZA-2S(**)	109-1657-6 **	2	21.75	24g
RM15WTRZA-3S(**)	109-1658-9 **	3	22.1	26g
RM15WTRZA-8S(**)	109-1660-0 **	8	21.6	24g
RM15WTRZA-10S(**)	109-1661-3 **	10		
RM15WTRZA-12S(**)	109-1662-6 **	12		

## ■ Receptacles (Square flange)

### ● Waterproof (When mated with corresponding plug)

RM15WTRZB-10S(71)

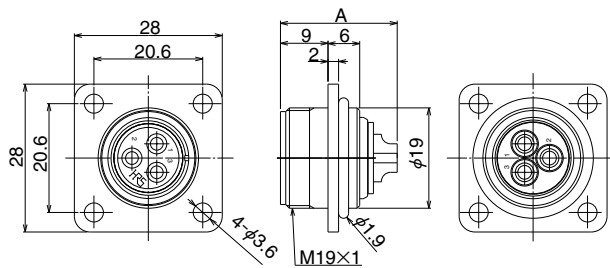

(Representative example)

[Specification number] (\*\*), -\*\*  
 (71) : Silver plated contacts  
 (72) : Gold plated contacts

Part No.	HRS No.	No. of contacts	A	Weight
RM15WTRZB-2P(**)	109-1671-7 **	2	21	19g
RM15WTRZB-3P(**)	109-1672-0 **	3	22.1	21g
RM15WTRZB-4P(**)	109-1673-2 **	4	21	20g
RM15WTRZB-8P(**)	109-1674-5 **	8	20.65	19g
RM15WTRZB-10P(**)	109-1675-8 **	10		20g
RM15WTRZB-12P(**)	109-1676-0 **	12		20g

Note 1 : Screw size : M3

Note 2 : Recommended nut tightening torque : 0.3 to 0.35N·m

Part No.	HRS No.	No. of contacts	A	Weight
RM15WTRZB-2S(**)	109-1677-3 **	2	21.75	21g
RM15WTRZB-3S(**)	109-1678-6 **	3	22.1	23g
RM15WTRZB-8S(**)	109-1680-8 **	8	21.6	21g
RM15WTRZB-10S(**)	109-1681-0 **	10		
RM15WTRZB-12S(**)	109-1682-3 **	12		

### ● Waterproof (single body)

RM15WTRZB-10PA(71)

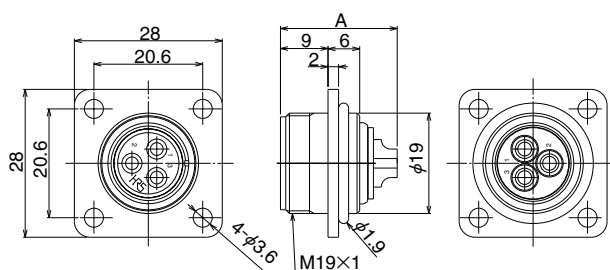

(Representative example)

[Specification number] (\*\*), -\*\*  
 (71) : Silver plated contacts  
 (72) : Gold plated contacts

Part No.	HRS No.	No. of contacts	A	Weight
RM15WTRZB-3PA(**)	109-1692 7	3	22.1	20g
RM15WTRZB-4PA(**)	109-1693 0	4	21	21g

Note 1 : Screw size : M3

Note 2 : Recommended nut tightening torque : 0.3 to 0.35N·m

Part No.	HRS No.	No. of contacts	A	Weight
RM15WTRZB-8PA(**)	109-1694 2	8	20.65	22g
RM15WTRZB-10PA(**)	109-1695 5	10	20.6	24g



**◆ Plug – Disassembly / Assembly**

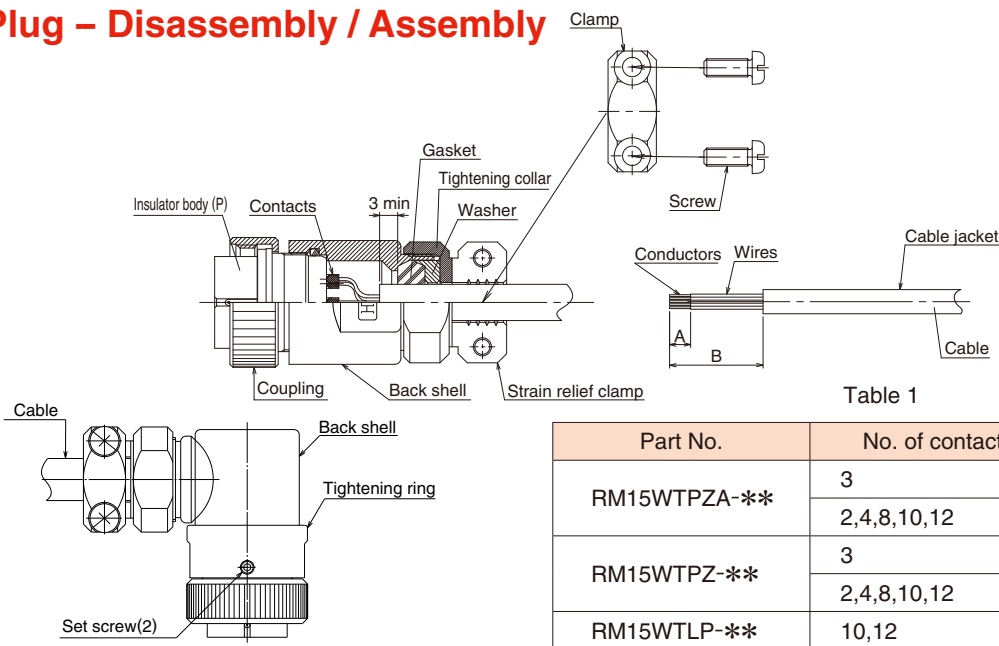

Table 1

Part No.	No. of contacts	A	B
RM15WTPZA-**	3	6mm	21mm
	2,4,8,10,12	3mm	
RM15WTPZ-**	3	6mm	12mm
	2,4,8,10,12	3mm	
RM15WTLP-**	10,12	3mm	25mm

**Disassembly**

- ① Fix the plug in the assembly fixture (RM15TP-T01 (HRS No.150-0098-0)), then remove the insulator body (P) and the back shell. Right-angle plugs have set screws in the tightening ring at 2 locations. Loosen the set screws before removing the back shell.  
② Remove the 2 screws of the strain relief clamp, and then remove the clamp from the tightening collar.

**Wiring**

- ① Assure that the cable outer diameter will fit the strain relief clamp, and is prepared as recommended in Table 1. It is recommended that the exposed conductors be pre-soldered, to assure easier insertion in the soldering cup.  
② Pass the parts over the cable in the order of: tightening collar, washer, bushing, back shell, and coupling. Refer to the drawings (above) for assembly orientation of all components.  
③ Solder the wires to the contacts of the insulator body (P).  
Use of heat-shrink tubing or another insulating media between the soldered contacts is suggested.

**Connector Assembly**

**Straight Plugs**

- ① Place the completely wired insulator body (P) in the assembly fixture secured in a vise. Insert in the coupling, then back shell. The back shell should be tightened to a torque of 3N·m.

**Right-angle Plugs**

- ① Place the completely wired insulator body (P) in an assembly fixture secured by a vise. Insert in the coupling, then back shell (with tightening ring). When attaching the back shell, orient the cable in the desired direction and fasten the tightening ring to the insulator body (P) with a torque of 3N·m. After this, tighten and fix the 2 sets crews with a torque of 0.2 to 0.25N·m.

**Additional assembly recommendations :**

- In applications where continuous extremely high vibrations may be encountered it is recommended that a thread locking compound be applied to male threads prior to assembly (Loctite 263 manufactured by Henkel Japan K.K. or equivalent)
- ② Assemble in the following order : gasket then washer, then the tightening-collar. During assembly, make sure to keep the tip of the cable sheath at least 3mm from the gasket, as shown in the figure (above).
  - ③ To prevent loosening of the male threads, apply Loctite 263 (Henkel Japan K.K. or equivalent) to the male threads of the back shell. Then tighten the tightening-collar to a torque of 3N·m with the clamp and the cable so that the cable cannot rotate. (Screw-tightening torque : 0.65 to 0.70N·m)

**Points to be checked**

- ① This connector has a waterproof feature. Please verify that the assembled connector is waterproof by conducting the test described below.
  - ② Because the force required to secure the strain relief clamp differs with the cable structure, please check the connector assembly before use to make sure there is no rotation.
4. (Test verification of waterproof capability)  
Apply air pressure of 17.6kPa for 30 seconds from the mating end of the plug connector. No air should leak from inside the connector.

**Waterproof verification - plug assembly**

Apply air pressure of 17.6kPa for 30 seconds from the mating side of the plug assembly. There shall not be any air leakage from inside the connector when submerged in the water tank.

**Precautions**

5. The waterproof capability may be impaired if the cable sheath or gasket is damaged or contaminated when performing the assembly. Please handle carefully.

## ◆ Receptacle - recommended panel cut-outs

Front mounting, rear nut

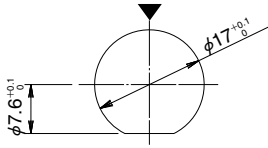

Panel thickness : 0.5 to 2mm

For RM15WTRZ receptacles

Rear mounting, front nut

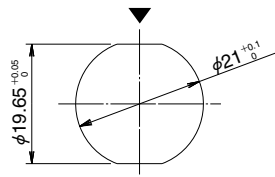

Panel thickness : 0.5 to 2.5mm

For RM15WTRZA receptacles

Square flange, screw mounting

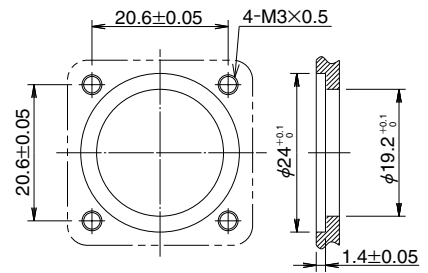

Panel thickness : 2.5 to 4mm

For RM15WTRZB receptacles

Note 1 : When attaching the receptacle to the panel, be certain to check that the gasket is in place in the groove. Do not pinch the gasket.

Note 2 : The view of the above diagrams is from the receptacle mating side.

Note 3 : The ▼ symbol in the above diagrams indicates the coupling guide position of the receptacles.

## ◆ Contact Arrangement and Specifications

Contact arrangement	Shell size : 15					
No. of contacts	2	3	4	8	10	12
Withstanding voltage	1,800V AC / 1 minute	2,000V AC / 1 minute	1,500V AC / 1 minute		1,000V AC / 1 minute	
Current rating	10A			5A		
Insulation resistance	1,000MΩ min.					
Contact resistance	2mΩ max.			4mΩ max.		
Solder pot inner diameter	1.7mm	2.8mm	1.7mm	1.1mm		

Note 1 : The contact configuration as viewed from the wiring side.

Note 2 : The ▼ symbol in the above diagrams indicates the coupling guide position of the receptacles.

Note 3 : Withstanding voltages indicate test voltage values.

## ◆ Precautions

1. Switch off the power of the circuit before disconnecting or plugging in the connectors.
2. Use a connectors with socket contacts at the power side of the circuit.
3. Make sure that the coupling is in completely cocked position.
4. Use correct plug / receptacle to assure dust and water protection.

## Product Specifications (RM21WT to RM31WT size products)

Rating	Voltage rating	600V AC, 840V DC (40 pos.) 500V AC, 700V DC (15, 55 pos.) 350V AC, 490V DC (20 pos.)
	Current rating	5A
	Operating temperature range (Note 1)	-25°C to +85°C
	Storage temperature range (Note 2)	-10°C to +60°C

Characteristic	Specification	Conditions
1. Contact resistance	4mΩ max.	1A DC
2. Insulation resistance	1,000MΩ min	500V DC
3. Withstanding voltage	No flashover or insulation breakdown.	1,800V AC/one minute (40 pos.) 1,500V AC/one minute (15, 55 pos.) 1,000V AC/one minute (20 pos.)
4. Vibration	No electrical discontinuity for 10μs max.	Frequency : 10 to 55Hz, single amplitude of 0.75mm, for 3 hours in 3 axis.
5. Shock	No electrical discontinuity for 10μs max.	Acceleration of 490m/s <sup>2</sup> , 11ms duration, sine half-wave waveform, 3 cycles in each of the 3 axis.
6. Durability (insertion/withdrawal)	8mΩ max.	2,000 cycles
7. Temperature cycle	Insulation resistance : 100MΩ min.	Temperature : -55°C → Room temperature → +85°C → Room temperature Time : 30 → 10 to 15 → 30 → 10 to 15 (Minutes) 5 cycles
8. Humidity	Insulation resistance : 100MΩ min. (Dry state)	96 hours at temperature of 40°C and humidity of 90% to 95%.
9. Water / dust protection	When mated with corresponding connector.	Complete dust protection. No water penetration when submerged for 48 hours at the depth of 1.8 meter.

Note 1 : Includes temperature rise caused by the current flow.

Note 2 : The term "storage" refers to products stored for long period of time prior to mounting and use. Operating temperature range and humidity range covers non-conducting condition of installed connectors in storage, shipment or during transportation.

## Materials / Finish

Item	Material	Finish	Remarks
Body	Brass	Chrome plated or nickel plated	—————
Insulator	Diallyl phthalate resin	—————	UL94V-0 (Color : Black)
Contacts	Brass, copper alloy	Silver plated	—————
Packing	Chloroprene rubber or SIR	—————	(Color : Black)

Note : Do not mix different contact plating.

## Product Number Structure

Refer to the chart below when determining the product specifications from the product number.

Please select from the product numbers listed in this catalog when placing orders.

**RM 31 W T P\* - 40 S (\*\*)**  
 ① ② ③ ④ ⑤ ⑥ ⑦

① Series name : RM-W	⑤ Number of contacts
② Shell size	⑥ Contact type P : Male contact S : Female contact
③ Lock type T : Screw Lock	
④ Connector type P : Plug R : Receptacle	⑦ Other specifications A two-digit number is added to indicate other specifications.

**RM 21 W T P - CP (10) (\*\*)**  
 ⑧ ⑨ ⑦

⑧ CP: Strain relief	⑨ ( ) with : External cable clamp ( ) without : Internal cable clamp Numbers : Cable size
---------------------	---

## Plugs - Straight Short Back Shell

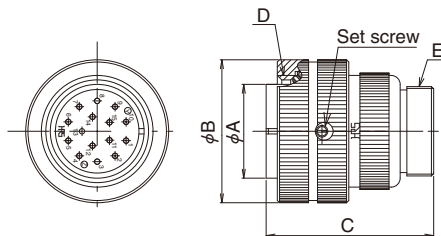

(Representative example)

Part No.	HRS No.	No. of contacts	φA	φB	C	E	F	Weight	Remarks
RM21WTP-15P(71)	109-1403-8 71	15	21	32	37.5	TM25×2	M20×0.75	85g	Silver plated only
RM21WTP-20P(71)	109-1404-0 71	20						85g	
RM31WTP-40S(71)	109-1571-2 71	40	30.8	42	52	TM35×2	M28×0.75	152g	
RM31WTP-40P(71)	109-1573-8 71							157g	
RM31WTP-55S(71)	109-1572-5 71	55						150g	
RM31WTP-55P(71)	109-1574-0 71							150g	

Note : Recommended set screw tightening torque : 0.2 to 0.3 N·m.

## Applicable Strain Reliefs

### External cable clamp + internal, self-tightening

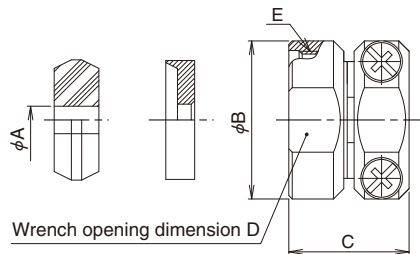

(Representative example)

Part No.	HRS No.	φA	φB	C	D	E	Weight	Remarks
JR16WCC-4(72)	114-2052-6 72	4	23	17.5	21	M20×0.75	17.5g	For RM21WT (No locking screw attached)
JR16WCC-6(72)	114-2053-9 72	6						
JR16WCC-8(72)	114-2054-1 72	8						
JR16WCC-10(72)	114-2055-4 72	10						
JR16WCC-11(72)	114-2154-6 72	11						
JR16WCC-12(72)	114-2056-7 72	12						

Note 1 : Cable jacket diameter: Use A ± 0.2mm.

Note 2 : HRS recommended tool : 1.27mm Hex Wrench

Note 3 : Recommended set screw tightening torque : 0.3 to 0.4N·m.

### Internal, self tightening

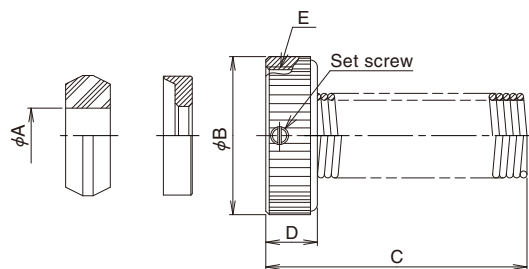

(Representative example)

Part No.	HRS No.	φA	φB	C	D	E	Weight	Remarks
RM21WTP-CP(8)(71)	109-1405-3 71	8	23	38	7.5	M20×0.75	22.5g	For RM21WT
RM21WTP-CP(10)(71)	109-1406-6 71	10					22g	
RM21WTP-CP(12)(71)	109-1407-9 71	12					21.5g	
RM31WTP-CP(10)(71)	109-1575-3 71	10	31	42	12	M28×0.75	46g	For RM31WT
RM31WTP-CP(12)(71)	109-1576-6 71	12					45g	
RM31WTP-CP(14)(71)	109-1579-4 71	14					43.5g	
RM31WTP-CP(16)(71)	109-1577-9 71	16					42g	
RM31WTP-CP(18)(71)	109-1578-1 71	18						

Note 1 : Cable jacket diameter : Use A ± 0.2mm.

Note 2 : Code cramp No. should be the same as connector shell No.

Note 3 : When using the self-tightening strain relief verify the cable pull force requirements.

Note 4 : Recommended set screw tightening torque : 0.2 to 0.3N·m.

## ■ Receptacles

### ● Front panel mount

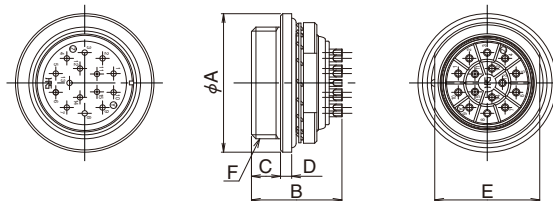

(Representative example)

Part No.	HRS No.	No. of contacts	φA	B	C	D	E	F	Weight	Remarks	
RM21WTR-15P(71)	109-1445-8 71	15	31	21	6.5	2.5	23.5	TM25×2	28g	Silver plated only	
RM21WTR-20P(71)	109-1446-0 71	20							31.5g		
RM31WTR-40S(71)	109-1527-0 71	40	41				34	TM35×2	52g		50g
RM31WTR-40P(71)	109-1525-5 71										
RM31WTR-55S(71)	109-1528-3 71	55	53.5g								
RM31WTR-55P(71)	109-1526-8 71										

### ◆ Receptacle - recommended panel cut-out

Front mounting, rear nut

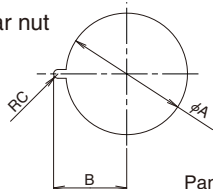

Panel thickness : 0.5 to 2mm

Part No.	φA	B	RC
For RM21WTR	22.1	12.75	0.8
For RM31WTR	32.1	17.75	0.85

Note : Tolerance is +0.1/0.

For RM\*\*WTR receptacles

Note 1 : When attaching the receptacle to the panel, be certain to check that the gasket is in place in the groove. Do not pinch the gasket.

Note 2 : The view of the above diagrams is from the receptacle mating side.

Note 3 : The ▼ symbol in the above diagrams indicates the coupling guide position of the receptacles.

### ◆ Contact Arrangement and Specifications

Contact arrangement	Shell size : 21		Shell size : 31
Number of contacts	15	20	55
Withstanding voltage	1,500V AC / 1 minute	1,000V AC / 1 minute	1,500V AC / 1 minute
Current rating	5A		
Insulation resistance	1,000MΩ min.		
Contact resistance	4mΩ max.		
Solder pot inner diameter	1.1mm		

Note 1 : The contact configuration as viewed from the wiring side.

Note 2 : The ▼ symbol in the above diagrams indicates the coupling guide position of the receptacles.

Note 3 : Withstanding voltages indicate test voltage values.

### ◆ Precautions

1. Switch off the power of the circuit before disconnecting or plugging in the connectors.
2. Use a connectors with socket contacts at the power side of the circuit.
3. Make sure that the coupling is in completely locked position.
4. Use correct plug / receptacle to assure dust and water protection.



# HIROSE ELECTRIC CO.,LTD.

2-6-3,Nakagawa Chuoh,Tsuzuki-Ku,Yokohama-Shi 224-8540,JAPAN

TEL: +81-45-620-3526 Fax: +81-45-591-3726

<http://www.hirose.com>

<http://www.hirose-connectors.com>