



Chipsmall Limited consists of a professional team with an average of over 10 year of expertise in the distribution of electronic components. Based in Hongkong, we have already established firm and mutual-benefit business relationships with customers from,Europe,America and south Asia,supplying obsolete and hard-to-find components to meet their specific needs.

With the principle of “Quality Parts,Customers Priority,Honest Operation,and Considerate Service”,our business mainly focus on the distribution of electronic components. Line cards we deal with include Microchip,ALPS,ROHM,Xilinx,Pulse,ON,Everlight and Freescale. Main products comprise IC,Modules,Potentiometer,IC Socket,Relay,Connector.Our parts cover such applications as commercial,industrial, and automotives areas.

We are looking forward to setting up business relationship with you and hope to provide you with the best service and solution. Let us make a better world for our industry!



Contact us

Tel: +86-755-8981 8866 Fax: +86-755-8427 6832

Email & Skype: info@chipsmall.com Web: www.chipsmall.com

Address: A1208, Overseas Decoration Building, #122 Zhenhua RD., Futian, Shenzhen, China



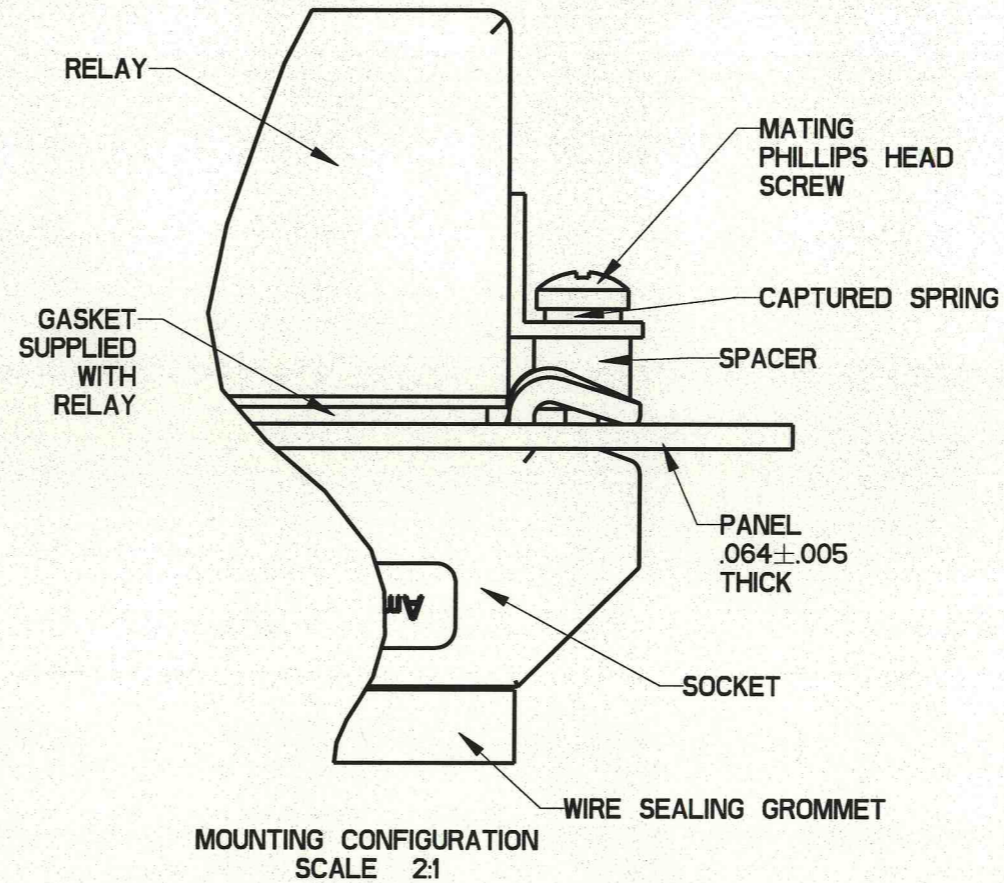
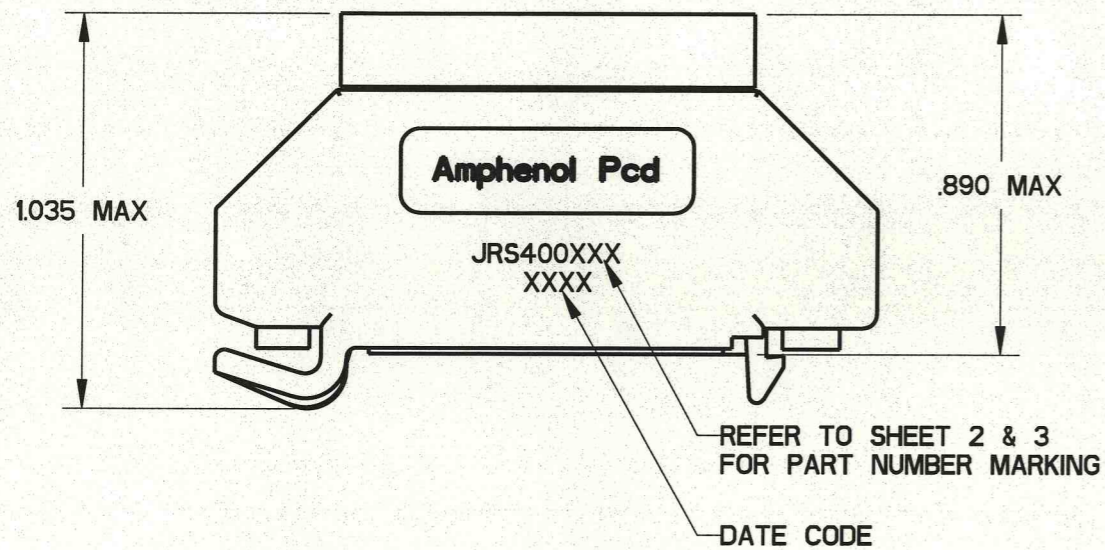
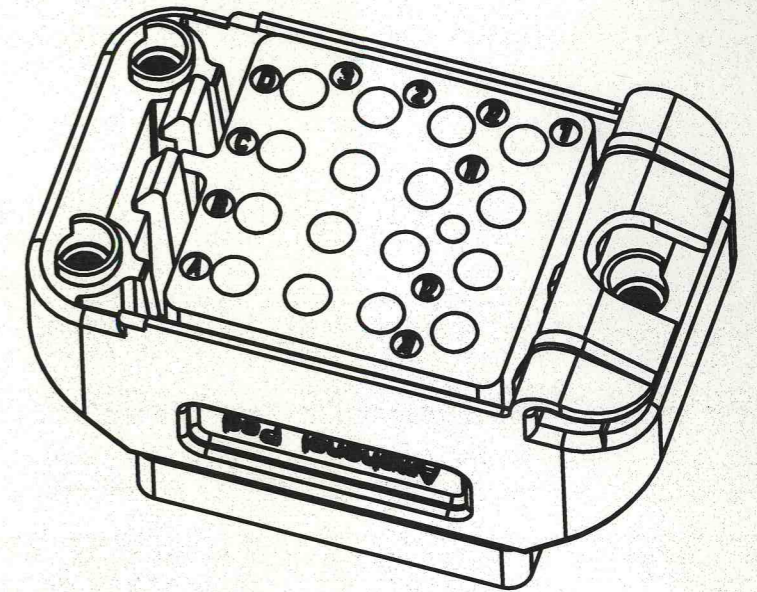
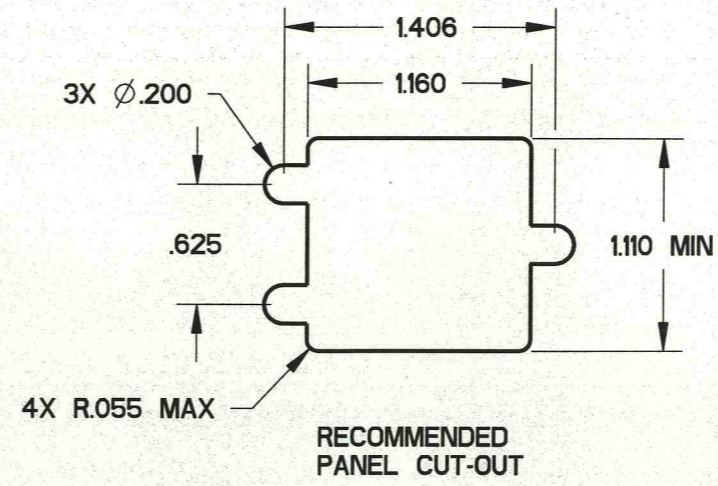
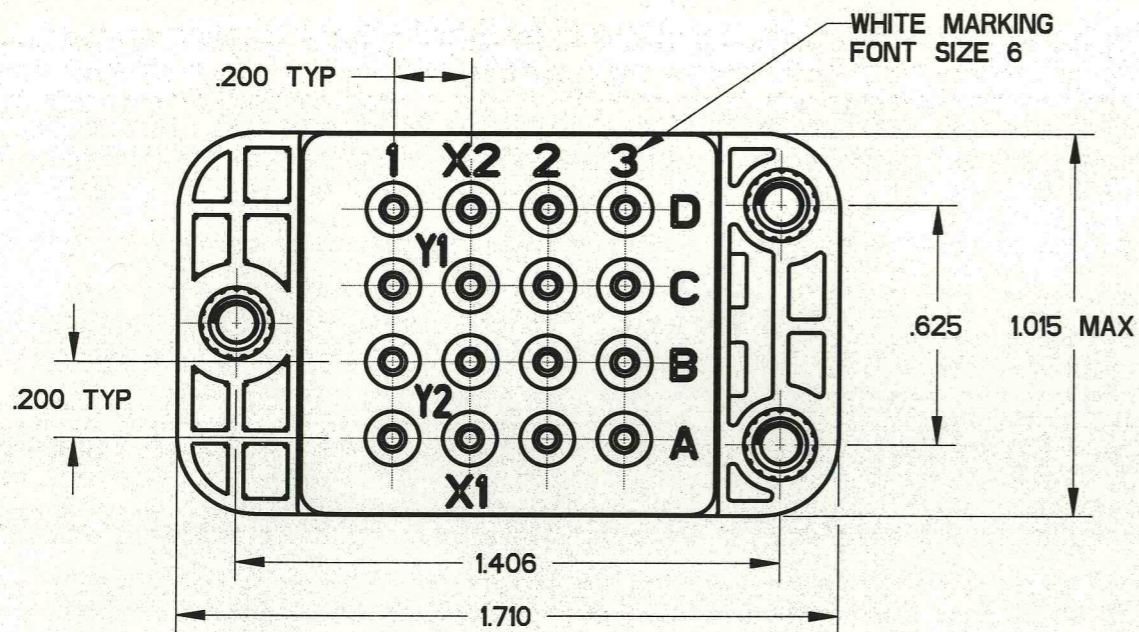

- NOTES:
- MATERIALS:
 HOUSING: POLYETHERIMIDE PER ASTM-D5205
 GROMMET: SILICONE RUBBER PER A-A-59588
 THREADED INSERT: STAINLESS STEEL
 - OPERATING RANGE:
 TEMPERATAURE: -65 °C TO 125 °C
 INSULATION RESISTANCE: 1000 MEGOHMS MIN.
 DIELECTRIC WITHSTANDING VOLTAGE: 1500 VRMS AT SEA LEVEL AND 500 VRMS AT 80,000 FT. ALTITUDE
 VIBRATION: MIL-STD-202, METHOD 204, TEST CONDITION G
 SHOCK: MIL-STD-202, METHOD 213, TEST CONDITION C
 - PART ACCEPTS M39029/92-533 AND M39029/92-534 SOCKET CONTACTS, SIZE 16/16 AND SIZE 16/20.

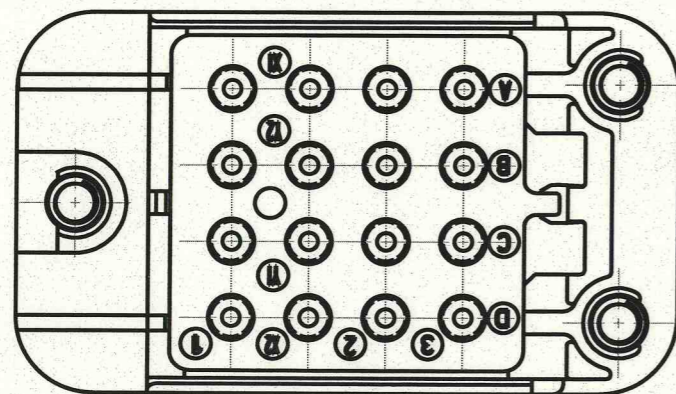

DIMENSIONS ANSI Y14.5M UNITS: INCHES Pro/E FILE	TOLERANCES .XX ±0.01 .XXX ±0.005 ANGLES ±1.0°	PROJECTION 	Amphenol Pcd SPECIFICATION DRAWING		TITLE SNAP-IN RELAY SOCKET 4 POLE		
			ENGR Frank.Li 07-Apr-08		SIZE	DWG NO.	REV
ORIGINAL 	THIS DOCUMENT CONTAINS PROPRIETARY INFORMATION WHICH IS THE CONFIDENTIAL PROPERTY OF AMPHENOL PCD INC., BEVERLY, MA			CHKD 5/29/09	B JRS400100	-	
				APPD	CODE: 58982	SCALE: 2:1	SHEET 1 OF 3

JRS400100

JRS400100

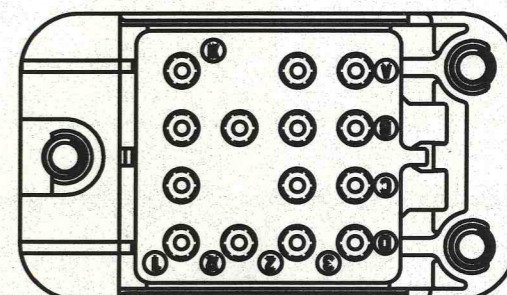
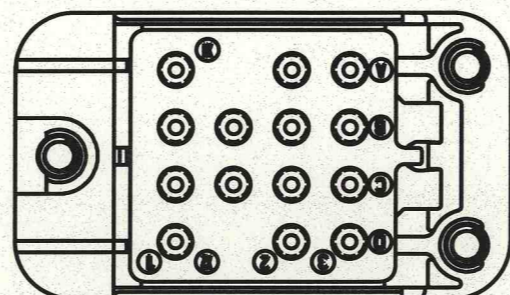
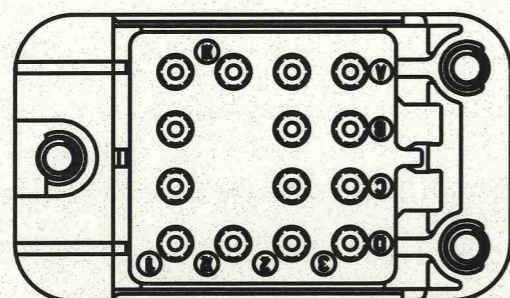
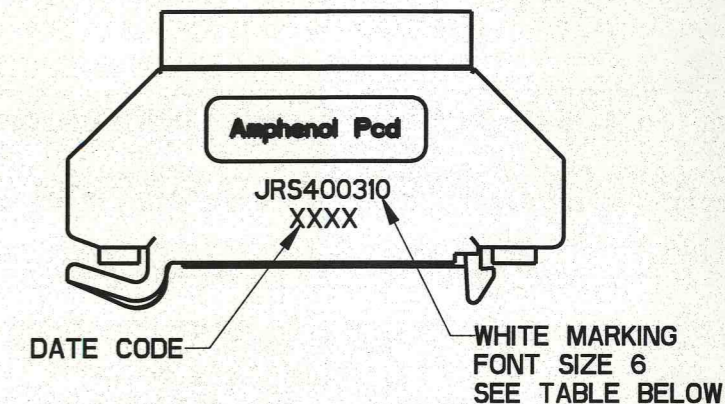
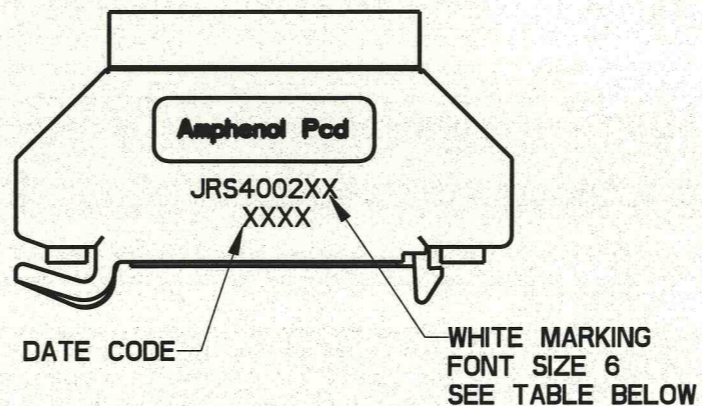
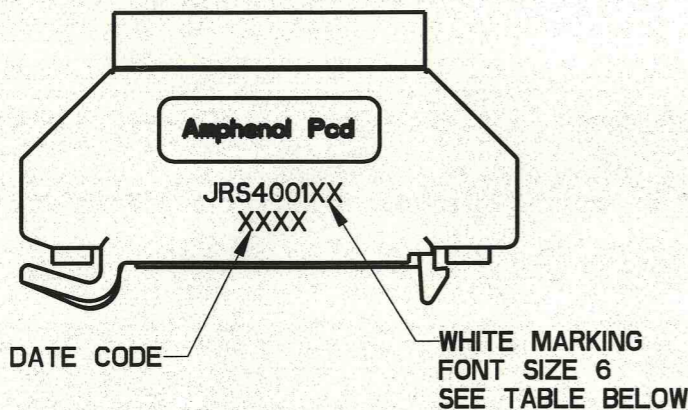
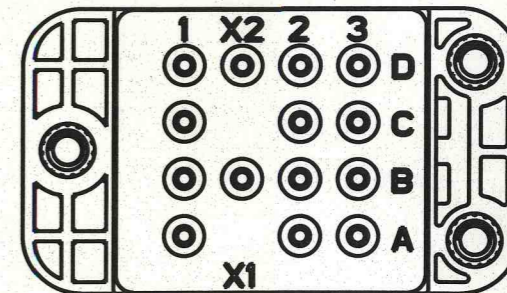
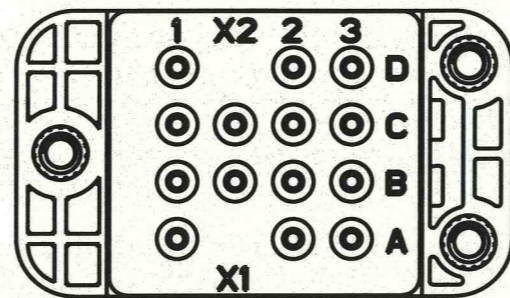
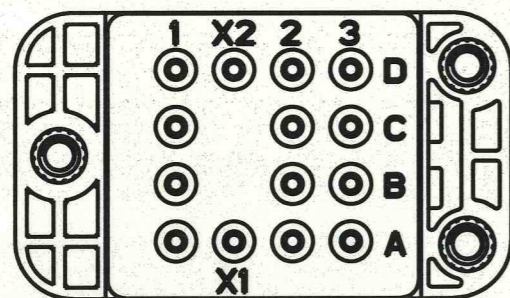

JRS4001XX

JRS4002XX

JRS4003XX

PART NUMBER TABLE

APCD P/N	HARDWARE PACKAGE	CONTACTS SUPPLIED
JRS400100	NONE	NONE
JRS400101	NONE	YES
JRS400110	YES	NONE
JRS400111	YES	YES

PART NUMBER TABLE

APCD P/N	HARDWARE PACKAGE	CONTACTS SUPPLIED
JRS400200	NONE	NONE
JRS400201	NONE	YES
JRS400210	YES	NONE
JRS400211	YES	YES

PART NUMBER TABLE

APCD P/N	HARDWARE PACKAGE	CONTACTS SUPPLIED
JRS400300	NONE	NONE
JRS400301	NONE	YES
JRS400310	YES	NONE
JRS400311	YES	YES

SIZE B	DWG NO. JRS400100	REV -
CODE: 58982	SCALE: 2:1	SHEET 2 OF 3

JRS400100

JRS400100

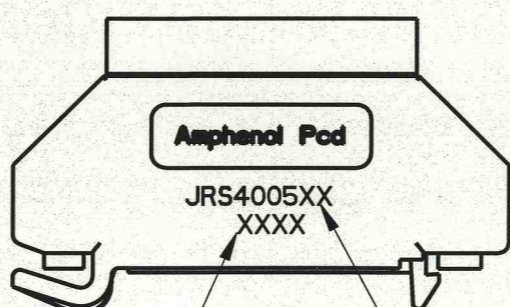
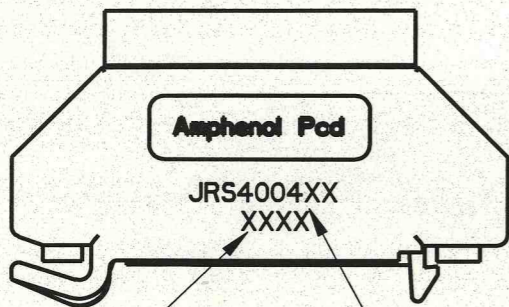
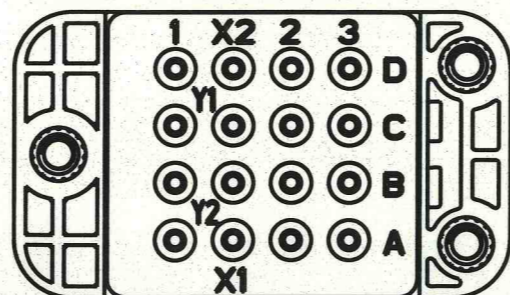
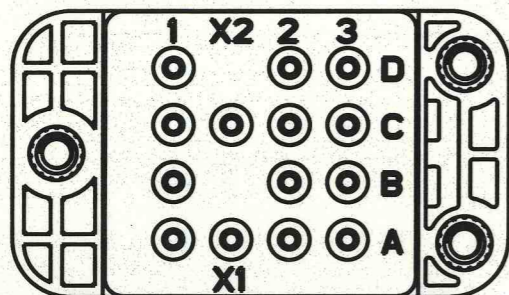

DATE CODE → WHITE MARKING
FONT SIZE 6
SEE TABLE BELOW

DATE CODE → WHITE MARKING
FONT SIZE 6
SEE TABLE BELOW

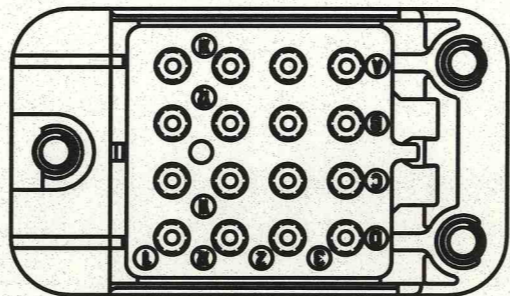
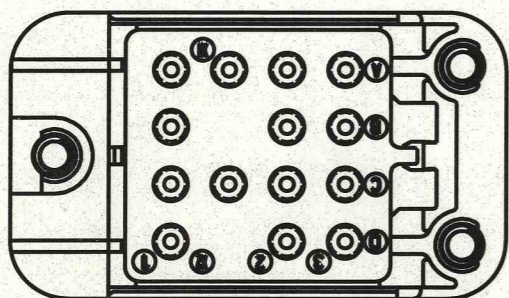

JRS4004XX

JRS4005XX

PART NUMBER TABLE

APCD P/N	HARDWARE PACKAGE	CONTACTS SUPPLIED
JRS400400	NONE	NONE
JRS400401	NONE	YES
JRS400410	YES	NONE
JRS400411	YES	YES

PART NUMBER TABLE

APCD P/N	HARDWARE PACKAGE	CONTACTS SUPPLIED
JRS400500	NONE	NONE
JRS400501	NONE	YES
JRS400510	YES	NONE
JRS400511	YES	YES

JRS400100

JRS400100

SIZE B	DWG NO. JRS400100	REV -
CODE: 58982	SCALE: 2:1	SHEET 3 OF 3