



Chipsmall Limited consists of a professional team with an average of over 10 year of expertise in the distribution of electronic components. Based in Hongkong, we have already established firm and mutual-benefit business relationships with customers from,Europe,America and south Asia,supplying obsolete and hard-to-find components to meet their specific needs.

With the principle of “Quality Parts,Customers Priority,Honest Operation,and Considerate Service”,our business mainly focus on the distribution of electronic components. Line cards we deal with include Microchip,ALPS,ROHM,Xilinx,Pulse,ON,Everlight and Freescale. Main products comprise IC,Modules,Potentiometer,IC Socket,Relay,Connector.Our parts cover such applications as commercial,industrial, and automotives areas.

We are looking forward to setting up business relationship with you and hope to provide you with the best service and solution. Let us make a better world for our industry!



## Contact us

Tel: +86-755-8981 8866 Fax: +86-755-8427 6832

Email & Skype: info@chipsmall.com Web: www.chipsmall.com

Address: A1208, Overseas Decoration Building, #122 Zhenhua RD., Futian, Shenzhen, China



# General Specifications

Toggle

Rockers

Pushbuttons

Illuminated PB

Programmable

Keylocks

Rotaries

Slides

Tactiles

Tilt

Touch

Indicators

Accessories

Supplement

### Electrical Capacity (Resistive Load)

**Switching Rating:** 25mA @ 24V DC  
**Nonswitching Rating:** 0.1A @ 50V DC

### Other Ratings

	JS02 Extended Actuator	JS04 Flush Actuator
<b>Contact Resistance:</b>	50 milliohms maximum	50 milliohms maximum
<b>Insulation Resistance:</b>	100 megohms minimum @ 500V DC	100 megohms minimum @ 100V DC
<b>Dielectric Strength:</b>	500V AC minimum for 1 minute minimum	300V AC minimum for 1 minute minimum
<b>Mechanical Life:</b>	2,000 operations minimum	2,000 operations minimum
<b>Electrical Life:</b>	2,000 operations minimum	2,000 operations minimum
<b>Total Travel:</b>	.031" (0.8mm)	.026" (0.65mm)

### Materials & Finishes

	JS02 Extended Actuator	JS04 Flush Actuator
<b>Actuator:</b>	Glass fiber reinforced polyamide	Glass fiber reinforced polyamide
<b>Cover:</b>	Glass fiber reinforced polyamide (UL94V-0)	Glass fiber reinforced polyamide (UL94V-0)
<b>Base:</b>	Glass fiber reinforced polyamide (UL94V-0)	Glass fiber reinforced polyamide (UL94V-0)
<b>Contacts:</b>	Beryllium copper with gold plating	Copper alloy with gold plating
<b>Terminals:</b>	Brass with gold plating	Brass with gold plating

### Environmental Data

<b>Operating Temp Range:</b>	<b>JS02 Extended Actuator:</b> -20°C through +70°C (-4°F through +158°F) <b>JS04 Flush Actuator:</b> -30°C through +85°C (-22°F through +185°F)
<b>Humidity:</b>	90 ~ 95% humidity for 96 hours @ 40°C (104°F)
<b>Vibration:</b>	10 ~ 55Hz with peak-to-peak amplitude of 1.5mm traversing the frequency range & returning in 1 minute; 3 right angled directions for 2 hours
<b>Shock:</b>	50G (490m/s <sup>2</sup> ) acceleration (tested in 6 right angled directions, with 5 shocks in each direction)

### PCB Processing

<b>Soldering:</b>	Reflow Soldering Recommended. See Profile A in Supplement section. Manual Soldering: See Profile A in Supplement section. Note: Switches are packaged in OFF position and should be soldered in OFF position.
<b>Cleaning:</b>	These devices are not process sealed. Hand clean locally using alcohol based solution.

### Standards & Certifications

<b>Flammability Standards:</b>	UL 94V-0 rated cover & base The JS Series slides have not been tested for UL recognition or CSA certification. These switches are designed for use in a low-voltage, low-current circuit. When used as intended in a low-voltage, low-current circuit, the results do not produce hazardous energy.
--------------------------------	--

# Distinctive Characteristics

Extended and flush slide actuators available.

Twin sliding contact mechanism with self-cleaning action (JS02) provides smooth actuation and produces high contact reliability.

Gold plated contacts prevent oxidation and sulfide effect and provide stable contact resistance.

Use of self-extinguishing UL94V-0 certified material in cover and base provides high arc resistance and high insulation resistance.

Gull-wing terminals ensure secure PCB mounting and prevent dislodging during vapor phase and infrared convection reflow soldering.

Terminal spacing conforms to standard PCB grid.  
 For JS02: .100" (2.54mm)  
 For JS04: .050" (1.27mm)

End-to-end stackable.

Packaged in tape-reel or stick-tube. Tape-reel packaging meets EIA-481-D Standard.

Coplanarity: all considered surfaces must lie between two parallel planes that are a maximum distance apart of .0059" (0.15mm). (Additional coplanarity details in Terms and Acronyms in the Supplement section.)

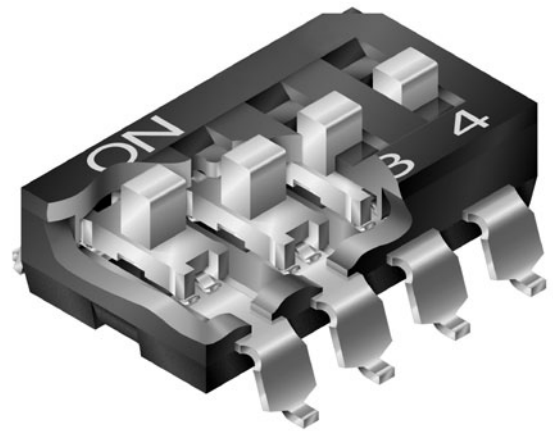

Actual Sizes

JS02



JS04



- Toggles
- Rockers
- Pushbuttons
- Illuminated PB
- Programmable
- Keylocks
- Rotaries
- H Slides**
- Tactiles
- Tilt
- Touch
- Indicators
- Accessories
- Supplement

### TYPICAL SWITCH ORDERING EXAMPLE

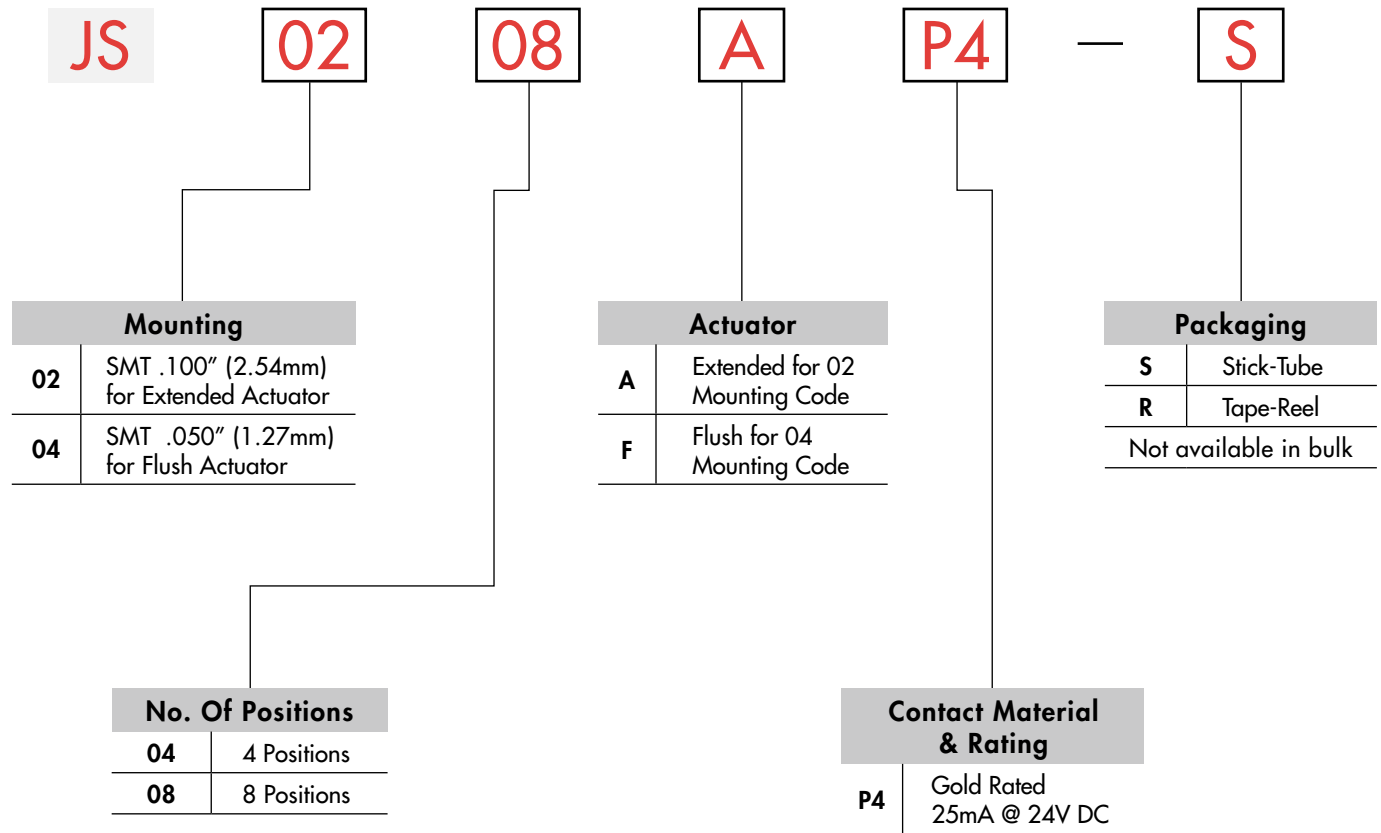

### DESCRIPTION FOR TYPICAL ORDERING EXAMPLE

**JS0208AP4-S**

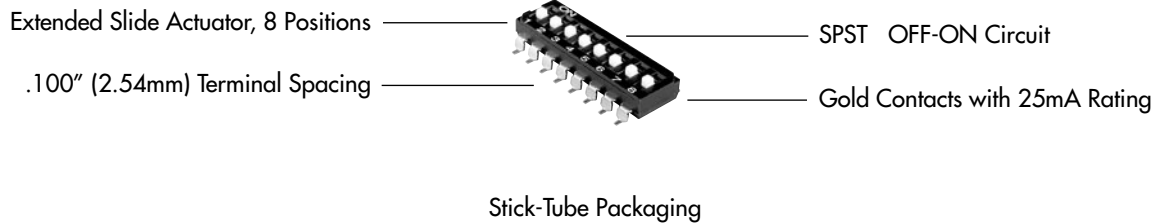

TYPICAL SWITCH DIMENSIONS

Single Pole

4 Positions • Extended Actuator

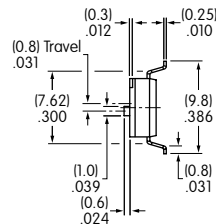
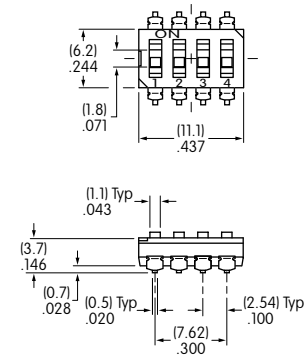

End View

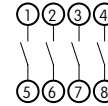
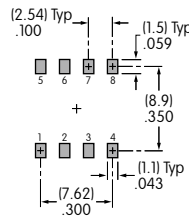

Schematic

JS0204AP4

Single Pole

8 Positions • Extended Actuator

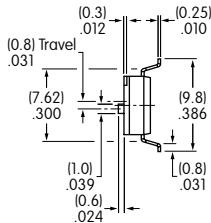
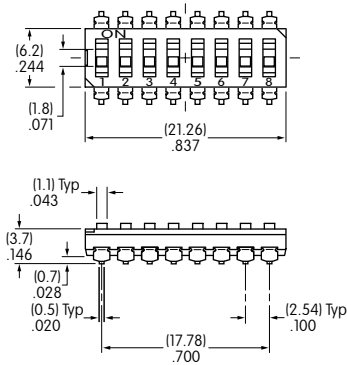

End View

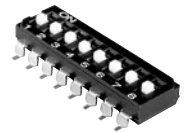
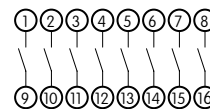
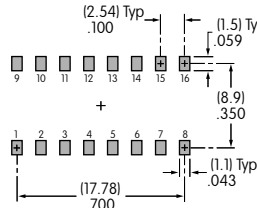

Schematic

JS0208AP4

Single Pole

4 Positions • Flush Actuator

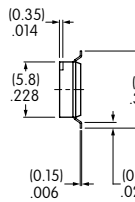
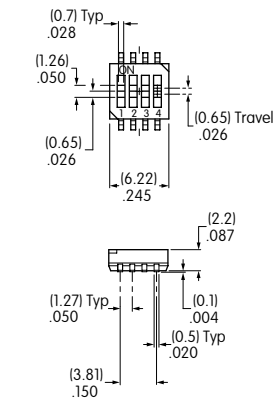

End View

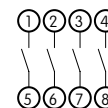
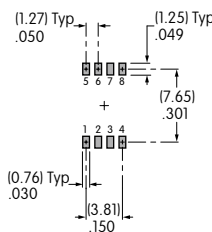

Schematic

JS0404FP4

Single Pole

8 Positions • Flush Actuator

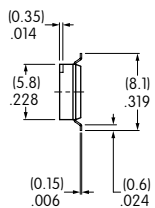
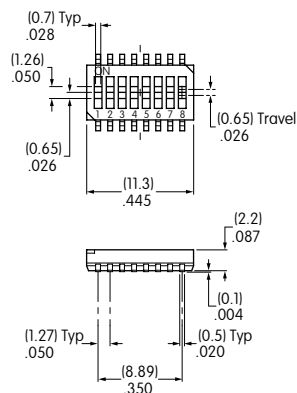

End View

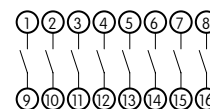
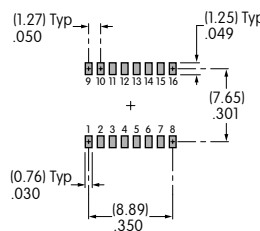

Schematic

JS0408FP4

## PACKAGING

**S**

### Stick-Tube Packaging

Switches are packaged in OFF position.  
Switches are not available in bulk and must be ordered in the following increments:

#### Extended Actuator

JS0204AP4-S: 46 pieces per stick-tube  
JS0208AP4-S: 24 pieces per stick-tube

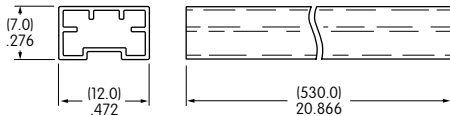

#### Flush Actuator

JS0404FP4-S: 80 pieces per stick-tube  
JS0408FP4-S: 45 pieces per stick-tube

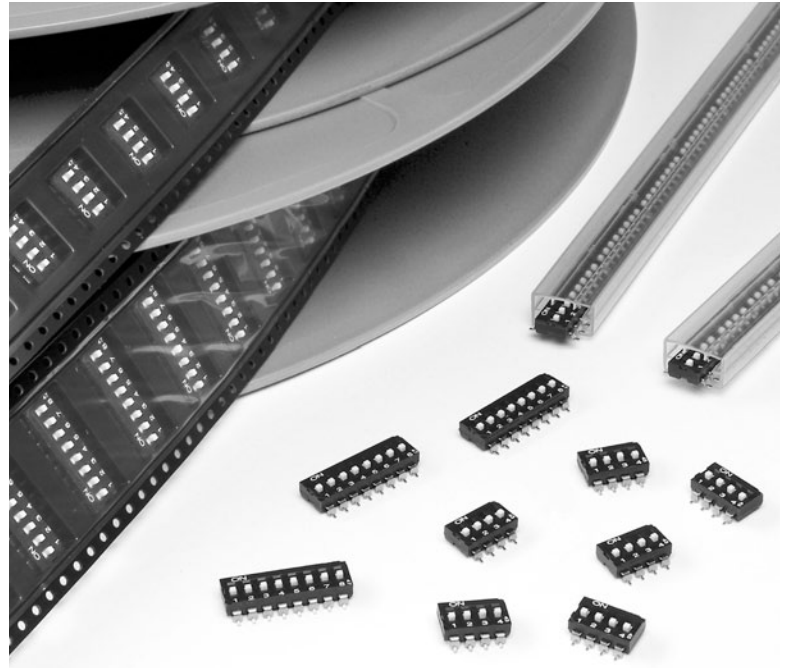
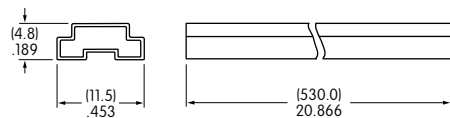

**R**

### Tape-Reel Packaging for Extended Actuator

Switches are packaged in OFF position.  
Switches are not available in bulk and must be ordered in the following increments:

JS0204AP4-R: 500 pieces per tape-reel  
JS0208AP4-R: 500 pieces per tape-reel

Minimum Leader Length: 15.75" (400mm)  
Minimum Trailer Length: 6.3" (160mm)

Tape-reel packaging meets EIA-481-D Standard.

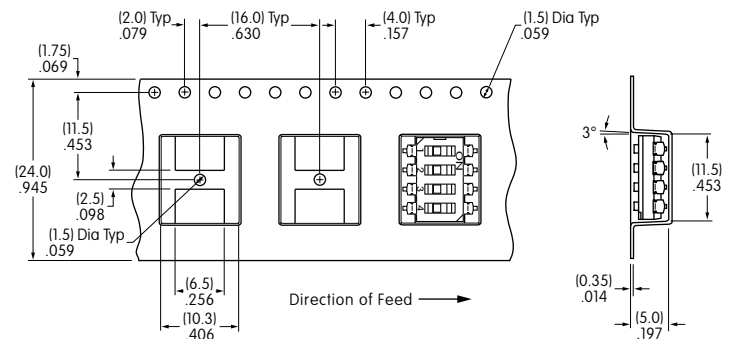

Tape Dimensions for JS0204AP4-R

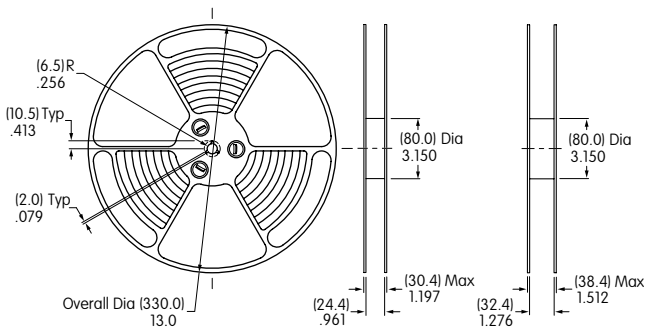

Reel Dimensions JS0204AP4-R JS0208AP4-R

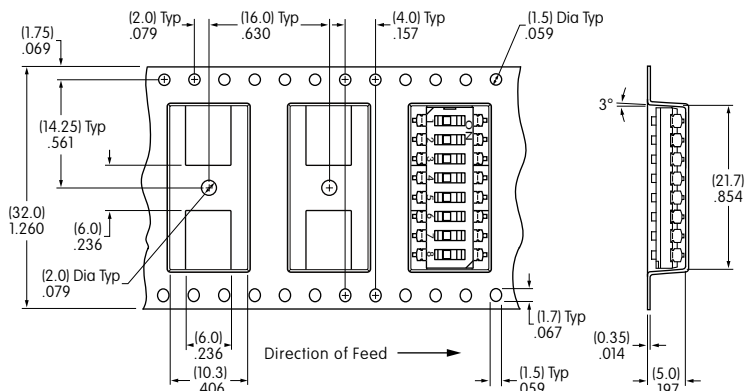

Tape Dimensions for JS0208AP4-R

Toggles

Rockers

Pushbuttons

Programmable Illuminated PB

Keylocks

Rotaries

Slides **H**

Tactiles

Tilt

Touch

Indicators

Accessories

Supplement

PACKAGING (CONTINUED)

**R**

**Tape-Reel Packaging for Flush Actuator**

Switches are packaged in OFF position.  
Switches are not available in bulk and must be ordered in the following increments:

- JS0404FP4-R: 2,000 pieces per tape-reel
- JS0408FP4-R: 2,000 pieces per tape-reel

Minimum Leader Length: 15.75" (400mm)  
Minimum Trailer Length: 6.3" (160mm)

Tape-reel packaging meets EIA-481-D Standard.

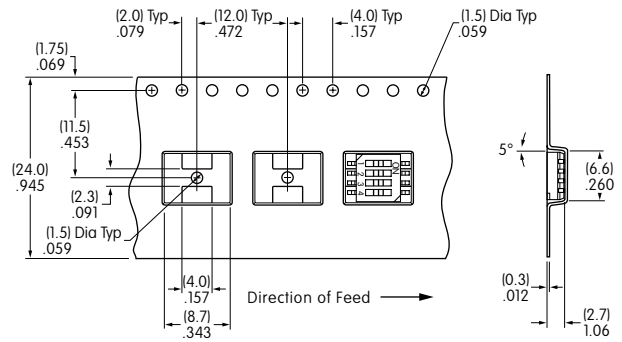

Tape Dimensions for JS0404FP4-R

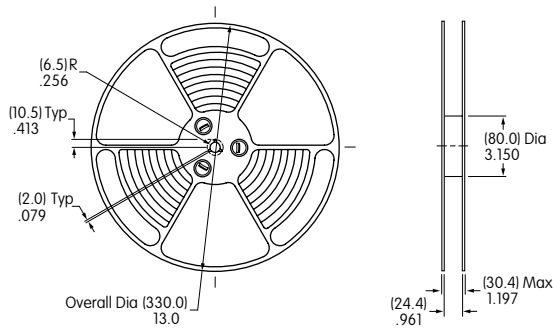

Reel Dimensions for JS0404FP4-R & JS0408FP4-R

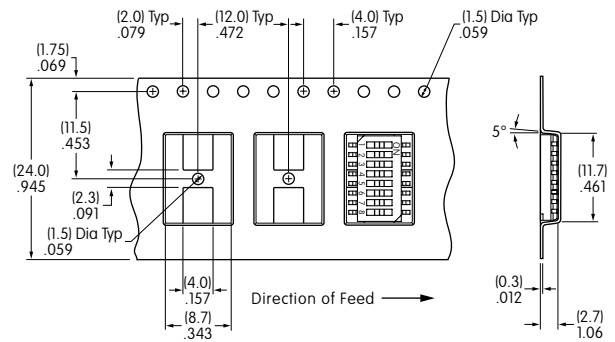

Tape Dimensions for JS0408FP4-R

Toggles

Rockers

Pushbuttons

Illuminated PB

Programmable

Keylocks

Rotaries

**H** Slides

Tactiles

Tilt

Touch

Indicators

Accessories

Supplement