



Chipsmall Limited consists of a professional team with an average of over 10 year of expertise in the distribution of electronic components. Based in Hongkong, we have already established firm and mutual-benefit business relationships with customers from,Europe,America and south Asia,supplying obsolete and hard-to-find components to meet their specific needs.

With the principle of “Quality Parts,Customers Priority,Honest Operation,and Considerate Service”,our business mainly focus on the distribution of electronic components. Line cards we deal with include Microchip,ALPS,ROHM,Xilinx,Pulse,ON,Everlight and Freescale. Main products comprise IC,Modules,Potentiometer,IC Socket,Relay,Connector.Our parts cover such applications as commercial,industrial, and automotives areas.

We are looking forward to setting up business relationship with you and hope to provide you with the best service and solution. Let us make a better world for our industry!



Contact us

Tel: +86-755-8981 8866 Fax: +86-755-8427 6832

Email & Skype: info@chipsmall.com Web: www.chipsmall.com

Address: A1208, Overseas Decoration Building, #122 Zhenhua RD., Futian, Shenzhen, China



Radial Leaded Multilayer Ceramic Capacitors for General Purpose Class 1, Class 2 and Class 3, 50 V_{DC}, 100 V_{DC}, 200 V_{DC}, 500 V_{DC}

FEATURES

- High capacitance with small size
- High reliability
- Crimp and straight leadstyles
- Material categorization:
For definitions of compliance please see www.vishay.com/doc?99912

RoHS
COMPLIANT

APPLICATIONS

- Temperature compensation
- Coupling and decoupling

QUICK REFERENCE DATA										
DESCRIPTION	VALUE									
Ceramic Class	1				2				3	
Ceramic Dielectric	C0G				X7R				Y5V	
Voltage (V _{DC})	50	100	200	500	50	100	200	500	50	100
Min. Capacitance (pF)	10	10	33	33	100	100	100	100	10 000	10 000
Max. Capacitance (pF)	10 000	5600	3900	1800	1 000 000	560 000	220 000	47 000	1 000 000	220 000
Mounting	Radial									

MARKING

Marking indicates capacitance value and tolerance in accordance with "EIA 198" and voltage marks.

OPERATING TEMPERATURE RANGE

C0G, X7R: - 55 °C to + 125 °C

Y5V: - 30 °C to + 85 °C

TEMPERATURE CHARACTERISTICS

Class 1: C0G

Class 2: X7R

Class 3: Y5V

SECTIONAL SPECIFICATIONS

Climatic category (acc. to EN 60058-1)

Class 1 and 2: 55/125/21

Class 3: 30/85/21

APPROVALS

EIA 198

IEC 60384-9

DESIGN

- The capacitors consist of a general purpose MLCC
- The lead wires are 0.5 mm and are made of 100 % tinned copper clad steel wire
- The capacitors may be supplied with straight or kinked leads having a lead spacing of 2.5 mm and 5.0 mm
- Coating is made of yellow colored flame retardant epoxy resin in accordance with UL 94 V-0

CAPACITANCE RANGE

10 pF to 1 μF

TOLERANCE ON CAPACITANCE

± 5 %, ± 10 %, ± 20 %, + 80 %/- 20 %

RATED VOLTAGE

50 V_{DC}, 100 V_{DC}, 200 V_{DC}, 500 V_{DC}

TEST VOLTAGE

- 50 V_{DC} and 100 V_{DC}: 250 % of rated voltage
- 200 V_{DC}: 150 % of rated voltage + 100 V_{DC}
- 500 V_{DC}: 130 % of rated voltage + 100 V_{DC}

INSULATION RESISTANCE AT 500 V_{DC}

- 50 V_{DC} and 100 V_{DC}: 100 GΩ or 1000 ΩF whichever is less at rated voltage within 2 min of charging
- 200 V_{DC} and 500 V_{DC}: 10 GΩ or 100 ΩF whichever is less at rated voltage within 2 min of charging

DISSIPATION FACTOR

- Class 1 0.1 % max. when C ≥ 30 pF
(at 1 MHz; 1 V where C ≤ 1000 pF, and at 1 kHz; 1 V where C > 1000 pF)
For C < 30 pF: DF = 100/(400 + 20 x C)
DF = Dissipation factor in %;
C = Capacitance value in pF
- Class 2 2.5 % max. (at 1 kHz; 1 V)
- Class 3 5 % max. (at 1 kHz; 1 V)

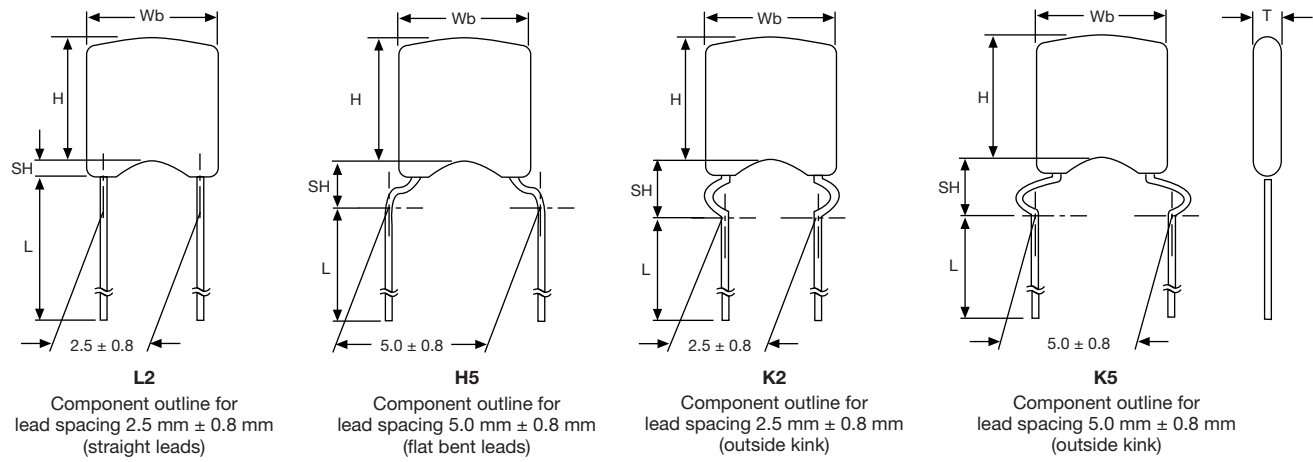
LEAD CONFIGURATION AND DIMENSIONS (in millimeters)

SIZE CODE	Wb _{MAX.}	H _{MAX.}	T _{MAX.}	MAXIMUM SEATING HEIGHT (SH)			
				L2	H5	K2	K5
10	3.6	3.6	2.3	1.6	2.6	3.5	-
15	4.0	4.0	2.6	1.6	2.6	3.5	3.5
20	5.0	5.0	3.2	1.6	2.6	3.5	3.5

Notes

- Bulk packed types have a standard lead length L = 30 mm ± 5 mm.
- The K5 lead style is not available for size 10.
- L2 and H5 are preferred styles.

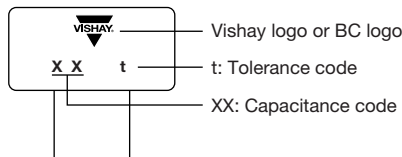
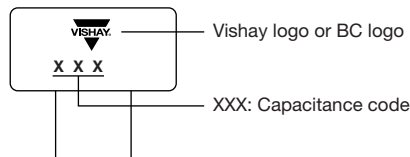
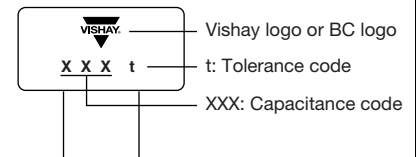
MARKING
SIZE 10 AND 15 CAPACITANCE VALUE < 100 pF

SIZE 10 AND 15 CAPACITANCE VALUE ≥ 100 pF

SIZE 20

Notes

- The capacitance code indicates actual capacitance in pF when capacitance value < 100 pF.
- Two significant digits followed by one digit for the multiplier as given following: 1 = * 10, 2 = * 100, 3 = * 1000, 4 = * 10 000, 5 = * 100 000.
- The tolerance codes are J = 5 %, K = 10 %, M = 20 % and Z = + 80 %/- 20 %.

ORDERING CODE INFORMATION

K	104	K	15	X7R	F	5	3	H	5
1	2 3 4	5	6 7	8 9 10	11	12	13	14	15
Product Type	Capacitance (pF)	Capacitance Tolerance	Size Code	T.C. Code	Rated Voltage	Lead Diameter	Packaging/Lead Length	Lead Style	Lead Spacing
K = Radial leaded MLCC	The first two digits are the significant figures of capacitance and the last digit is a multiplier as follows: 0 = * 1 1 = * 10 2 = * 100 3 = * 1000 4 = * 10 000 5 = * 100 000	J = ± 5 % K = ± 10 % M = ± 20 % Z = + 80 %/ - 20 %	Please refer to relevant datasheet	Please refer to relevant datasheet	F = 50 V _{DC} H = 100 V _{DC} K = 200 V _{DC} L = 500 V _{DC}	5 = 0.50 mm ± 0.05 mm	3 = Bulk T = Tape and reel U = Ammo	H = Flat crimp L = Straight K = Outside crimp	2 = 2.5 mm 5 = 5.0 mm



ORDERING CODES

DIELECTRIC COG						
CAP. (pF)	50 V _{DC}		100 V _{DC}		200 V _{DC}	500 V _{DC}
	SMALLER SIZE	NORMAL SIZE	SMALLER SIZE	NORMAL SIZE	NORMAL SIZE	NORMAL SIZE
10	K100#10C0GF5###	K100#15C0GF5###	K100#10C0GH5###	K100#15C0GH5###	-	-
12	K120#10C0GF5###	K120#15C0GF5###	K120#10C0GH5###	K120#15C0GH5###	-	-
15	K150#10C0GF5###	K150#15C0GF5###	K150#10C0GH5###	K150#15C0GH5###	-	-
18	K180#10C0GF5###	K180#15C0GF5###	K180#10C0GH5###	K180#15C0GH5###	-	-
22	K220#10C0GF5###	K220#15C0GF5###	K220#10C0GH5###	K220#15C0GH5###	-	-
27	K270#10C0GF5###	K270#15C0GF5###	K270#10C0GH5###	K270#15C0GH5###	-	-
33	K330#10C0GF5###	K330#15C0GF5###	K330#10C0GH5###	K330#15C0GH5###	K330#15C0GK5###	K330#15C0GL5##5
39	K390#10C0GF5###	K390#15C0GF5###	K390#10C0GH5###	K390#15C0GH5###	K390#15C0GK5###	K390#15C0GL5##5
47	K470#10C0GF5###	K470#15C0GF5###	K470#10C0GH5###	K470#15C0GH5###	K470#15C0GK5###	K470#15C0GL5##5
56	K560#10C0GF5###	K560#15C0GF5###	K560#10C0GH5###	K560#15C0GH5###	K560#15C0GK5###	K560#15C0GL5##5
68	K680#10C0GF5###	K680#15C0GF5###	K680#10C0GH5###	K680#15C0GH5###	K680#15C0GK5###	K680#15C0GL5##5
82	K820#10C0GF5###	K820#15C0GF5###	K820#10C0GH5###	K820#15C0GH5###	K820#15C0GK5###	K820#15C0GL5##5
100	K101#10C0GF5###	K101#15C0GF5###	K101#10C0GH5###	K101#15C0GH5###	K101#15C0GK5###	K101#15C0GL5##5
120	K121#10C0GF5###	K121#15C0GF5###	K121#10C0GH5###	K121#15C0GH5###	K121#15C0GK5###	K121#15C0GL5##5
150	K151#10C0GF5###	K151#15C0GF5###	K151#10C0GH5###	K151#15C0GH5###	K151#15C0GK5###	K151#15C0GL5##5
180	K181#10C0GF5###	K181#15C0GF5###	K181#10C0GH5###	K181#15C0GH5###	K181#15C0GK5###	K181#15C0GL5##5
220	K221#10C0GF5###	K221#15C0GF5###	K221#10C0GH5###	K221#15C0GH5###	K221#15C0GK5###	K221#15C0GL5##5
270	K271#10C0GF5###	K271#15C0GF5###	K271#10C0GH5###	K271#15C0GH5###	K271#15C0GK5###	K271#15C0GL5##5
330	K331#10C0GF5###	K331#15C0GF5###	K331#10C0GH5###	K331#15C0GH5###	K331#15C0GK5###	K331#15C0GL5##5
390	K391#10C0GF5###	K391#15C0GF5###	K391#10C0GH5###	K391#15C0GH5###	K391#15C0GK5###	K391#15C0GL5##5
470	K471#10C0GF5###	K471#15C0GF5###	K471#10C0GH5###	K471#15C0GH5###	K471#15C0GK5###	K471#20C0GL5##5
560	K561#10C0GF5###	K561#15C0GF5###	K561#10C0GH5###	K561#15C0GH5###	K561#15C0GK5###	K561#20C0GL5##5
680	K681#10C0GF5###	K681#15C0GF5###	-	K681#15C0GH5###	K681#15C0GK5###	K681#20C0GL5##5
820	K821#10C0GF5###	K821#15C0GF5###	-	K821#15C0GH5###	K821#15C0GK5###	K821#20C0GL5##5
1000	K102#10C0GF5###	K102#15C0GF5###	-	K102#20C0GH5###	K102#20C0GK5###	K102#20C0GL5##5
1200	-	K122#15C0GF5###	-	K122#20C0GH5###	K122#20C0GK5###	K122#20C0GL5##5
1500	-	K152#15C0GF5###	-	K152#20C0GH5###	K152#20C0GK5###	K152#20C0GL5##5
1800	-	K182#15C0GF5###	-	K182#20C0GH5###	K182#20C0GK5###	K182#20C0GL5##5
2200	-	K222#15C0GF5###	-	K222#20C0GH5###	K222#20C0GK5###	-
2700	-	K272#20C0GF5###	-	K272#20C0GH5###	K272#20C0GK5###	-
3300	-	K332#20C0GF5###	-	K332#20C0GH5###	K332#20C0GK5###	-
3900	-	K392#20C0GF5###	-	K392#20C0GH5###	K392#20C0GK5###	-
4700	-	K472#20C0GF5###	-	K472#20C0GH5###	-	-
5600	-	K562#20C0GF5###	-	K562#20C0GH5###	-	-
6800	-	K682#20C0GF5###	-	-	-	-
8200	-	K822#20C0GF5###	-	-	-	-
10 000	-	K103#20C0GF5###	-	-	-	-

Notes

- Lead diameter is 0.5 mm
- # 5th digit is capacitance tolerance code: ± 5 % = J; ± 10 % = K
- # 13th digit is packaging code: Bulk = 3; Reel = T; Ammo = U
- # 14th digit is lead style code: L; H; K (L and H are preferred lead configuration)
- # 15th digit is lead spacing code: 2.5 mm = 2; 5.0 mm = 5



DIELECTRIC X7R						
CAP. (pF)	50 V _{DC}		100 V _{DC}		200 V _{DC}	500 V _{DC}
	SMALLER SIZE	NORMAL SIZE	SMALLER SIZE	NORMAL SIZE	NORMAL SIZE	NORMAL SIZE
100	K101#10X7RF5###	K101#15X7RF5###	K101#10X7RH5###	K101#15X7RH5###	K101#15X7RK5###	K101#15X7RL5##5
120	K121#10X7RF5###	K121#15X7RF5###	K121#10X7RH5###	K121#15X7RH5###	K121#15X7RK5###	K121#15X7RL5##5
150	K151#10X7RF5###	K151#15X7RF5###	K151#10X7RH5###	K151#15X7RH5###	K151#15X7RK5###	K151#15X7RL5##5
180	K181#10X7RF5###	K181#15X7RF5###	K181#10X7RH5###	K181#15X7RH5###	K181#15X7RK5###	K181#15X7RL5##5
220	K221#10X7RF5###	K221#15X7RF5###	K221#10X7RH5###	K221#15X7RH5###	K221#15X7RK5###	K221#15X7RL5##5
270	K271#10X7RF5###	K271#15X7RF5###	K271#10X7RH5###	K271#15X7RH5###	K271#15X7RK5###	K271#15X7RL5##5
330	K331#10X7RF5###	K331#15X7RF5###	K331#10X7RH5###	K331#15X7RH5###	K331#15X7RK5###	K331#15X7RL5##5
390	K391#10X7RF5###	K391#15X7RF5###	K391#10X7RH5###	K391#15X7RH5###	K391#15X7RK5###	K391#15X7RL5##5
470	K471#10X7RF5###	K471#15X7RF5###	K471#10X7RH5###	K471#15X7RH5###	K471#15X7RK5###	K471#15X7RL5##5
560	K561#10X7RF5###	K561#15X7RF5###	K561#10X7RH5###	K561#15X7RH5###	K561#15X7RK5###	K561#15X7RL5##5
680	K681#10X7RF5###	K681#15X7RF5###	K681#10X7RH5###	K681#15X7RH5###	K681#15X7RK5###	K681#15X7RL5##5
820	K821#10X7RF5###	K821#15X7RF5###	K821#10X7RH5###	K821#15X7RH5###	K821#15X7RK5###	K821#15X7RL5##5
1000	K102#10X7RF5###	K102#15X7RF5###	K102#10X7RH5###	K102#15X7RH5###	K102#15X7RK5###	K102#15X7RL5##5
1200	K122#10X7RF5###	K122#15X7RF5###	K122#10X7RH5###	K122#15X7RH5###	K122#15X7RK5###	K122#15X7RL5##5
1500	K152#10X7RF5###	K152#15X7RF5###	K152#10X7RH5###	K152#15X7RH5###	K152#15X7RK5###	K152#15X7RL5##5
1800	K182#10X7RF5###	K182#15X7RF5###	K182#10X7RH5###	K182#15X7RH5###	K182#15X7RK5###	K182#15X7RL5##5
2200	K222#10X7RF5###	K222#15X7RF5###	K222#10X7RH5###	K222#15X7RH5###	K222#15X7RK5###	K222#15X7RL5##5
2700	K272#10X7RF5###	K272#15X7RF5###	K272#10X7RH5###	K272#15X7RH5###	K272#15X7RK5###	K272#15X7RL5##5
3300	K332#10X7RF5###	K332#15X7RF5###	K332#10X7RH5###	K332#15X7RH5###	K332#15X7RK5###	K332#20X7RL5##5
3900	K392#10X7RF5###	K392#15X7RF5###	K392#10X7RH5###	K392#15X7RH5###	K392#15X7RK5###	K392#20X7RL5##5
4700	K472#10X7RF5###	K472#15X7RF5###	K472#10X7RH5###	K472#15X7RH5###	K472#15X7RK5###	K472#20X7RL5##5
5600	K562#10X7RF5###	K562#15X7RF5###	K562#10X7RH5###	K562#15X7RH5###	K562#15X7RK5###	K562#20X7RL5##5
6800	K682#10X7RF5###	K682#15X7RF5###	K682#10X7RH5###	K682#15X7RH5###	K682#15X7RK5###	K682#20X7RL5##5
8200	K822#10X7RF5###	K822#15X7RF5###	K822#10X7RH5###	K822#15X7RH5###	K822#15X7RK5###	K822#20X7RL5##5
10 000	K103#10X7RF5###	K103#15X7RF5###	K103#10X7RH5###	K103#15X7RH5###	K103#15X7RK5###	K103#20X7RL5##5
12 000	K123#10X7RF5###	K123#15X7RF5###	-	K123#15X7RH5###	K123#15X7RK5###	K123#20X7RL5##5
15 000	K153#10X7RF5###	K153#15X7RF5###	-	K153#15X7RH5###	K153#15X7RK5###	K153#20X7RL5##5
18 000	K183#10X7RF5###	K183#15X7RF5###	-	K183#15X7RH5###	K183#15X7RK5###	K183#20X7RL5##5
22 000	K223#10X7RF5###	K223#15X7RF5###	-	K223#15X7RH5###	K223#15X7RK5###	K223#20X7RL5##5
27 000	K273#10X7RF5###	K273#15X7RF5###	-	K273#20X7RH5###	K273#20X7RK5###	K273#20X7RL5##5
33 000	K333#10X7RF5###	K333#15X7RF5###	-	K333#20X7RH5###	K333#20X7RK5###	K333#20X7RL5##5
39 000	K393#10X7RF5###	K393#15X7RF5###	-	K393#20X7RH5###	K393#20X7RK5###	K393#20X7RL5##5
47 000	K473#10X7RF5###	K473#15X7RF5###	-	K473#20X7RH5###	K473#20X7RK5###	K473#20X7RL5##5
56 000	K563#10X7RF5###	K563#15X7RF5###	-	K563#20X7RH5###	K563#20X7RK5###	-
68 000	K683#10X7RF5###	K683#15X7RF5###	-	K683#20X7RH5###	K683#20X7RK5###	-
82 000	K823#10X7RF5###	K823#15X7RF5###	-	K823#20X7RH5###	K823#20X7RK5###	-
100 000	K104#10X7RF5###	K104#15X7RF5###	-	K104#20X7RH5###	K104#20X7RK5###	-
150 000	-	K154#20X7RF5###	-	K154#20X7RH5###	K154#20X7RK5###	-
220 000	-	K224#20X7RF5###	-	K224#20X7RH5###	K224#20X7RK5###	-
330 000	-	K334#20X7RF5###	-	K334#20X7RH5###	-	-
470 000	-	K474#20X7RF5###	-	K474#20X7RH5###	-	-
560 000	-	K564#20X7RF5###	-	K564#20X7RH5###	-	-
680 000	-	K684#20X7RF5###	-	-	-	-
1 000 000	-	K105#20X7RF5###	-	-	-	-

Notes

- Lead diameter is 0.5 mm
- # 5th digit is capacitance tolerance code: ± 10 % = K; ± 20 % = M
- # 13th digit is packaging code: Bulk = 3; Reel = T; Ammo = U
- # 14th digit is lead style code: L; H; K (L and H are preferred lead configuration)
- # 15th digit is lead spacing code: 2.5 mm = 2; 5.0 mm = 5



DIELECTRIC Y5V			
CAP. (pF)	50 V _{DC}		100 V _{DC}
	SMALLER SIZE	NORMAL SIZE	NORMAL SIZE
10 000	K103Z10Y5VF5###	K103Z15Y5VF5###	K103Z15Y5VH5###
15 000	K153Z10Y5VF5###	K153Z15Y5VF5###	K153Z15Y5VH5###
22 000	K223Z10Y5VF5###	K223Z15Y5VF5###	K223Z15Y5VH5###
33 000	K333Z10Y5VF5###	K333Z15Y5VF5###	K333Z15Y5VH5###
47 000	K473Z10Y5VF5###	K473Z15Y5VF5###	K473Z15Y5VH5###
68 000	K683Z10Y5VF5###	K683Z15Y5VF5###	K683Z15Y5VH5###
100 000	K104Z10Y5VF5###	K104Z15Y5VF5###	K104Z15Y5VH5###
150 000	K154Z10Y5VF5###	K154Z15Y5VF5###	K154Z20Y5VH5###
220 000	-	K224Z15Y5VF5###	K224Z20Y5VH5###
330 000	-	K334Z20Y5VF5###	-
470 000	-	K474Z20Y5VF5###	-
680 000	-	K684Z20Y5VF5###	-
1 000 000	-	K105Z20Y5VF5###	-

Notes

- Lead diameter is 0.5 mm
- Tolerance is + 80 %/- 20 %
- # 13th digit is packaging code: Bulk = 3; Reel = T; Ammo = U
- # 14th digit is lead style code: L; H; K (L and H are preferred lead configuration)
- # 15th digit is lead spacing code: 2.5 mm = 2; 5.0 mm = 5

TAPING AND PACKAGING**LABELLING**

Each reel is provided with a label showing the following details:

Manufacturer, K style, capacitance, tolerance, batch number, quantity of components, rated voltage, dielectric.

On special request other designations can be shown.

For example:

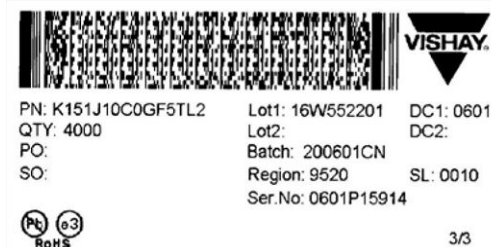

PACKAGING QUANTITIES AND BOX DIMENSIONS			
PACKAGING	SIZE CODE	SMALLEST PACKAGING QUANTITY (SPQ)	BOX DIMENSIONS L x W x H (mm)
Tape on reel	10, 15	4000	370 x 370 x 60
	20	3000	
Ammopack	10, 15, 20	2500	335 x 290 x 50
Bulk ⁽¹⁾	10, 15, 20	5000	245 x 120 x 65

Note

- ⁽¹⁾ SPQ contains one or a multiple of poly-bags, 1000 units per bag.

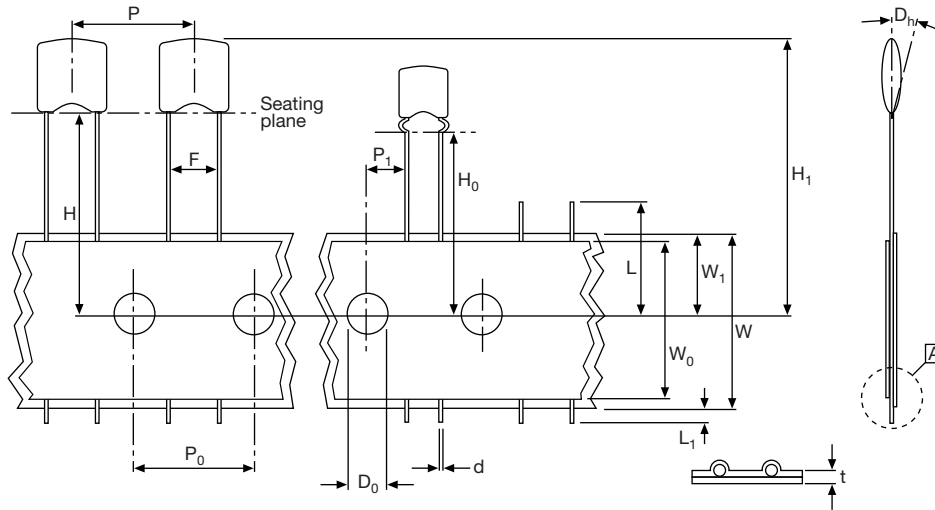
CAPACITORS ON TAPE

PARAMETER	SYMBOL	DIMENSIONS	
		mm	INCH
Cut-off length	L	≤ 11.0	≤ 0.443
Lead end protrusion	L ₁	≤ 1.0	≤ 0.039
Height to seating plane (straight leads)	H	≥ 18.0	≥ 0.709
Height to seating plane (crimp leads)	H ₀	16.0 ± 0.5	0.630 ± 0.020
Top of component height	H ₁	≤ 32	≤ 1.26
Body inclination	Δh	0.0 ± 1.0	0.000 ± 0.039
Carrier tape width	W	18.0 + 1.0/- 0.5	0.709 + 0.039/- 0.020
Hold down tape width	W ₀	15.0 REF.	0.591 REF.
Sprocket hole position	W ₁	9.00 + 0.075/- 0.50	0.354 + 0.030/- 0.020
Lead space	F	2.50 + 0.60/- 0.40	0.100 + 0.024/- 0.016
		5.00 + 0.60/- 0.40	0.200 + 0.024/- 0.016
Sprocket hole pitch	P ₀	12.70 ± 0.3	0.500 ± 0.012
Sprocket hole center to lead center at F = 2.5 mm	P ₁	5.08 ± 0.7	0.200 ± 0.028
Sprocket hole center to lead center at F = 5 mm		3.85 ± 0.7	0.150 ± 0.028
Sprocket hole diameter	D ₀	4.00 ± 0.30	0.157 ± 0.012
Overall tape thickness	t	≤ 0.90	≤ 0.035
Wire lead diameter	d	0.50 ± 0.05	0.020 ± 0.002
Taping pitch	P	12.7 REF.	0.50 REF.



REEL DATA

A maximum of 0.5 % of the total number of capacitors per reel may be missing.

A maximum of 1 consecutive vacant positions is followed by 6 consecutive components.

Tape begins and ends with a minimum of 4 empty positions (50 mm tape).

Maximum of 5 splicers per reel.

REEL

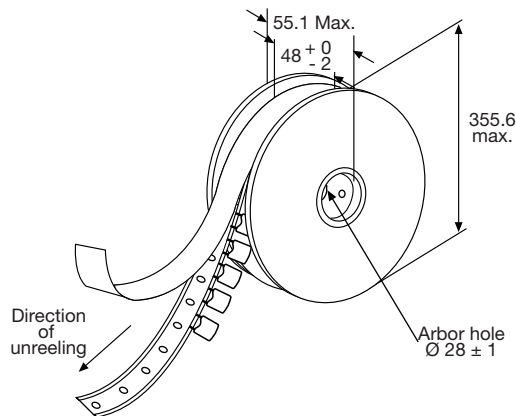

REEL DIMENSIONS		
REEL SIZE		(mm)
A	Outer diameter	355.6 max.
L	Hole diameter	28 ± 1.5
K	Core diameter	90
H ₁	Internal width	48 + 0/- 2
H ₂	External width	55 max.

AMMOPACK DATA

A maximum of 0.5 % of the total number of capacitors per box may be missing.

A maximum of 2 consecutive vacant positions is followed by 6 consecutive components.

Tape begins and ends with a minimum of 4 empty positions (50 mm tape).

Maximum of 5 splicers per reel.

The cumulative pitch tolerance over 20 consecutive units is not to exceed ± 1.0 mm.

Lead space (F) shall be measured at (3.6 ± 0.5) mm from the capacitor seating plane.

AMMOPACK

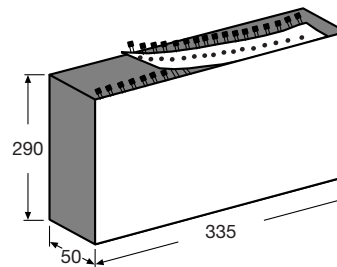

RELATED DOCUMENTS	
General Information	www.vishay.com/doc?45163



Disclaimer

ALL PRODUCT, PRODUCT SPECIFICATIONS AND DATA ARE SUBJECT TO CHANGE WITHOUT NOTICE TO IMPROVE RELIABILITY, FUNCTION OR DESIGN OR OTHERWISE.

Vishay Intertechnology, Inc., its affiliates, agents, and employees, and all persons acting on its or their behalf (collectively, "Vishay"), disclaim any and all liability for any errors, inaccuracies or incompleteness contained in any datasheet or in any other disclosure relating to any product.

Vishay makes no warranty, representation or guarantee regarding the suitability of the products for any particular purpose or the continuing production of any product. To the maximum extent permitted by applicable law, Vishay disclaims (i) any and all liability arising out of the application or use of any product, (ii) any and all liability, including without limitation special, consequential or incidental damages, and (iii) any and all implied warranties, including warranties of fitness for particular purpose, non-infringement and merchantability.

Statements regarding the suitability of products for certain types of applications are based on Vishay's knowledge of typical requirements that are often placed on Vishay products in generic applications. Such statements are not binding statements about the suitability of products for a particular application. It is the customer's responsibility to validate that a particular product with the properties described in the product specification is suitable for use in a particular application. Parameters provided in datasheets and/or specifications may vary in different applications and performance may vary over time. All operating parameters, including typical parameters, must be validated for each customer application by the customer's technical experts. Product specifications do not expand or otherwise modify Vishay's terms and conditions of purchase, including but not limited to the warranty expressed therein.

Except as expressly indicated in writing, Vishay products are not designed for use in medical, life-saving, or life-sustaining applications or for any other application in which the failure of the Vishay product could result in personal injury or death. Customers using or selling Vishay products not expressly indicated for use in such applications do so at their own risk. Please contact authorized Vishay personnel to obtain written terms and conditions regarding products designed for such applications.

No license, express or implied, by estoppel or otherwise, to any intellectual property rights is granted by this document or by any conduct of Vishay. Product names and markings noted herein may be trademarks of their respective owners.

Material Category Policy

Vishay Intertechnology, Inc. hereby certifies that all its products that are identified as RoHS-Compliant fulfill the definitions and restrictions defined under Directive 2011/65/EU of The European Parliament and of the Council of June 8, 2011 on the restriction of the use of certain hazardous substances in electrical and electronic equipment (EEE) - recast, unless otherwise specified as non-compliant.

Please note that some Vishay documentation may still make reference to RoHS Directive 2002/95/EC. We confirm that all the products identified as being compliant to Directive 2002/95/EC conform to Directive 2011/65/EU.

Vishay Intertechnology, Inc. hereby certifies that all its products that are identified as Halogen-Free follow Halogen-Free requirements as per JEDEC JS709A standards. Please note that some Vishay documentation may still make reference to the IEC 61249-2-21 definition. We confirm that all the products identified as being compliant to IEC 61249-2-21 conform to JEDEC JS709A standards.