



Chipsmall Limited consists of a professional team with an average of over 10 year of expertise in the distribution of electronic components. Based in Hongkong, we have already established firm and mutual-benefit business relationships with customers from,Europe,America and south Asia,supplying obsolete and hard-to-find components to meet their specific needs.

With the principle of “Quality Parts,Customers Priority,Honest Operation,and Considerate Service”,our business mainly focus on the distribution of electronic components. Line cards we deal with include Microchip,ALPS,ROHM,Xilinx,Pulse,ON,Everlight and Freescale. Main products comprise IC,Modules,Potentiometer,IC Socket,Relay,Connector.Our parts cover such applications as commercial,industrial, and automotives areas.

We are looking forward to setting up business relationship with you and hope to provide you with the best service and solution. Let us make a better world for our industry!



Contact us

Tel: +86-755-8981 8866 Fax: +86-755-8427 6832

Email & Skype: info@chipsmall.com Web: www.chipsmall.com

Address: A1208, Overseas Decoration Building, #122 Zhenhua RD., Futian, Shenzhen, China



KA5L0565R

Fairchild Power Switch(FPS™)

Features

- Precision Fixed Operating Frequency (50kHz)
- Low Start-up Current(Typ. 100uA)
- Pulse by Pulse Current Limiting
- Over Current Protection
- Over Voltage Protection (Min. 25V)
- Internal Thermal Shutdown Function
- Under Voltage Lockout
- Internal High Voltage Sense FET
- Auto-Restart Mode

Description

The Fairchild Power Switch(FPS) product family is specially designed for an off-line SMPS with minimal external components. The Fairchild Power Switch(FPS) consists of a high voltage power SenseFET and a current mode PWM IC. Included PWM controller integrates the fixed frequency oscillator, the under voltage lock-out, the leading edge blanking, the optimized gate turn-on/turn-off driver, the thermal shutdown protection, the over voltage protection, and the temperature compensated precision current sources for the loop compensation and the fault protection circuitry. Compared to a discrete MOSFET and a PWM controller or an RCCsolution, a Fairchild Power Switch(FPS) can reduce the total component count, design size and weight and at the same time increase efficiency, productivity, and system reliability. It has a basic platform well suited for the cost effective design in a flyback converter.

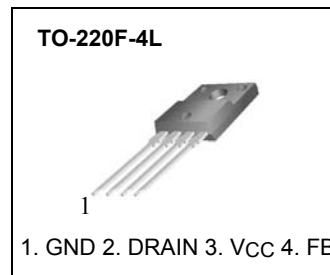

Internal Block Diagram

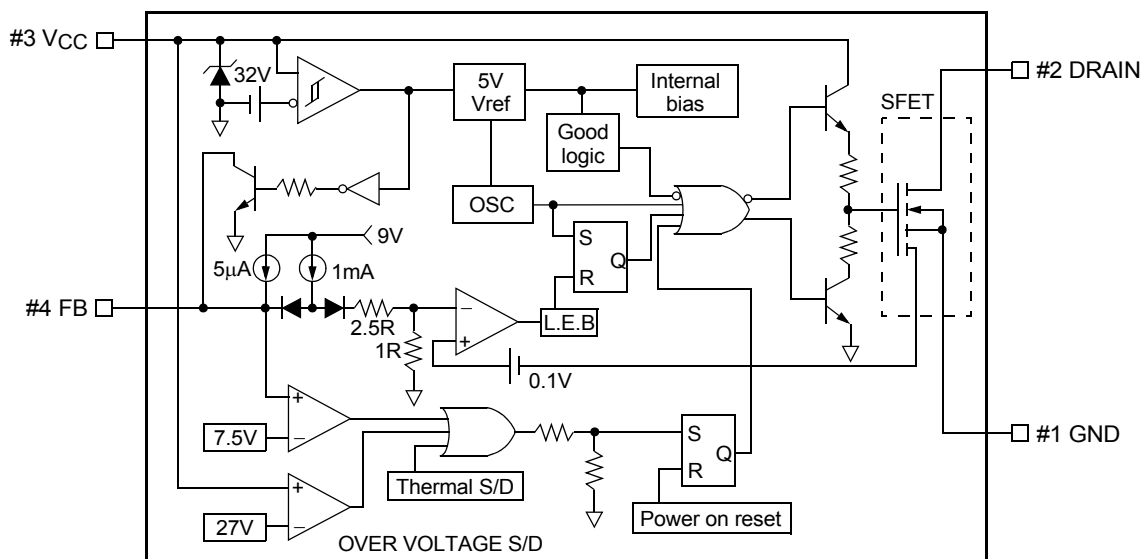

Rev.1.0.0

Absolute Maximum Ratings

Parameter	Symbol	Value	Unit
Drain-Gate Voltage ($R_{GS}=1M\Omega$)	V_{DGR}	650	V
Gate-Source (GND) Voltage	V_{GS}	± 30	V
Drain Current Pulsed ⁽²⁾	I_{DM}	20	ADC
Single Pulsed Avalanche Current ⁽³⁾ (Energy ⁽²⁾)	$I_{AS}(EAS)$	13(400)	A(mJ)
Continuous Drain Current ($T_C=25^\circ C$)	I_D	5.0	ADC
Continuous Drain Current ($T_C=100^\circ C$)	I_D	3.5	ADC
Maximum Supply Voltage	$V_{CC,MAX}$	30	V
Input Voltage Range	V_{FB}	-0.3 to V_{SD}	V
Total Power Dissipation	P_D	38	W
	Darting	0.3	W/ $^\circ C$
Operating Ambient Temperature	T_A	-25 to +85	$^\circ C$
Storage Temperature	T_{STG}	-55 to +150	$^\circ C$

Notes:

- $T_j = 25^\circ C$ to $150^\circ C$
- Repetitive rating: Pulse width limited by maximum junction temperature
- $L = 30mH$, $V_{DD} = 50V$, $R_G = 27\Omega$, starting $T_j = 25^\circ C$

Electrical Characteristics (SenseFET part)

(Ta=25°C unless otherwise specified)

Parameter	Symbol	Condition	Min.	Typ.	Max.	Unit
Drain-Source Breakdown Voltage	BVDSS	VGS=0V, ID=50μA	650	-	-	V
Zero Gate Voltage Drain Current	IDSS	VDS=Max., Rating, VGS=0V	-	-	50	μA
		VDS=0.8Max., Rating, VGS=0V, TC=125°C	-	-	200	μA
Static Drain-Source on Resistance ^(Note)	RDS(ON)	VGS=10V, ID=2.5A	-	1.76	2.2	Ω
Forward Transconductance ^(Note)	gfs	VDS=50V, ID=2.5A	2.5	-	-	S
Input Capacitance	Ciss	VGS=0V, VDS=25V, f=1MHz	-	1457	-	pF
Output Capacitance	Coss		-	130	-	
Reverse Transfer Capacitance	Crss		-	38.8	-	
Turn on Delay Time	td(on)	VDD=0.5BVDSS, ID=5.0A (MOSFET switching time are essentially independent of operating temperature)	-	-	60	nS
Rise Time	tr		-	-	150	
Turn Off Delay Time	td(off)		-	-	300	
Fall Time	tf		-	-	130	
Total Gate Charge (Gate-Source+Gate-Drain)	Qg	VGS=10V, ID=5.0A, VDS=0.5BVDSS (MOSFET switching time are essentially independent of operating temperature)	-	-	56	nC
Gate-Source Charge	Qgs		-	10.3	-	
Gate-Drain (Miller) Charge	Qgd		-	22.3	-	

Note:

1. Pulse test: Pulse width ≤ 300μS, duty cycle ≤ 2%

2. $S = \frac{1}{R}$

Electrical Characteristics (Control Part) (Continued)

(Ta=25°C unless otherwise specified)

Parameter	Symbol	Condition	Min.	Typ.	Max.	Unit
UVLO SECTION						
Start Threshold Voltage	VSTART	-	14	15	16	V
Stop Threshold Voltage	VSTOP	After turn on	8.4	9	9.6	V
OSCILLATOR SECTION						
Initial Accuracy	FOSC	KA5L0565R	45	50	55	kHz
Frequency Change With Temperature ⁽²⁾	$\Delta F/\Delta T$	-25°C ≤ Ta ≤ +85°C	-	±5	±10	%
Maximum Duty Cycle	Dmax	KA5L0565R	72	77	82	%
FEEDBACK SECTION						
Feedback Source Current	IFB	Ta=25°C, 0V ≤ Vfb ≤ 3V	0.7	0.9	1.1	mA
Shutdown Feedback Voltage	VSD	-	6.9	7.5	8.1	V
Shutdown Delay Current	Idelay	Ta=25°C, 5V ≤ Vfb ≤ VSD	4.0	5.0	6.0	μA
REFERENCE SECTION						
Output Voltage ⁽¹⁾	Vref	Ta=25°C	4.80	5.00	5.20	V
Temperature Stability ⁽¹⁾⁽²⁾	Vref/ΔT	-25°C ≤ Ta ≤ +85°C	-	0.3	0.6	mV/°C
CURRENT LIMIT (SELF-PROTECTION) SECTION						
Peak Current Limit	I _{OVER}	Max. inductor current	1.76	2.00	2.24	A
PROTECTION SECTION						
Thermal Shutdown Temperature (Tj) ⁽¹⁾	TSD	-	140	160	-	°C
Over Voltage Protection Voltage	VOVP	-	25	27	29	V
TOTAL DEVICE SECTION						
Start Up Current	I _{START}	VCC=14V	-	100	170	uA
Operating Supply Current (Control Part Only)	I _{OP}	Ta=25°C	-	7	12	mA

Note:

1. These parameters, although guaranteed, are not 100% tested in production
2. These parameters, although guaranteed, are tested in EDS (wafer test) process

Typical Performance Characteristics

(These characteristic graphs are normalized at $T_a=25^\circ\text{C}$)

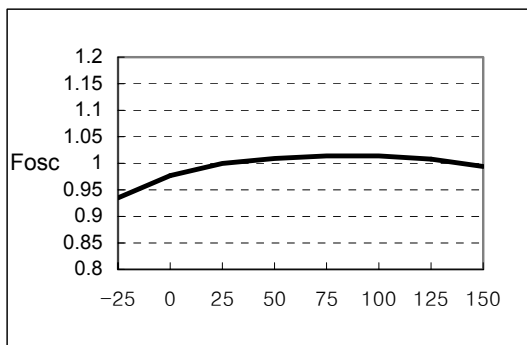

Figure 1. Operating Frequency

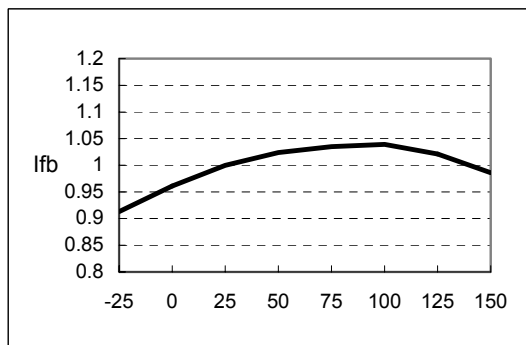

Figure 2. Feedback Source Current

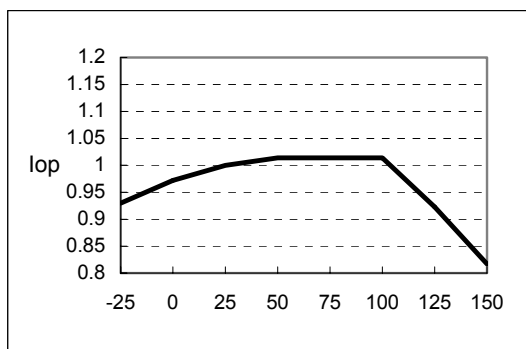

Figure 3. Operating Supply Current

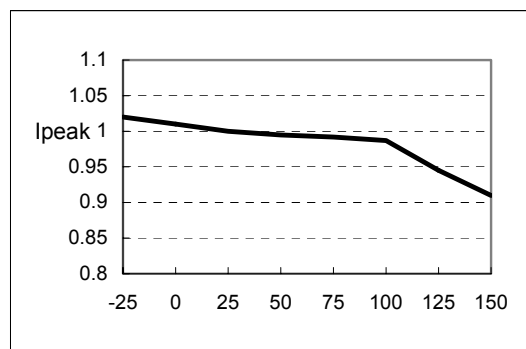

Figure 4. Peak Current Limit

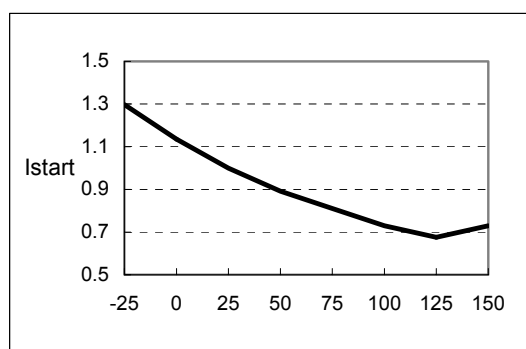

Figure 5. Start up Current

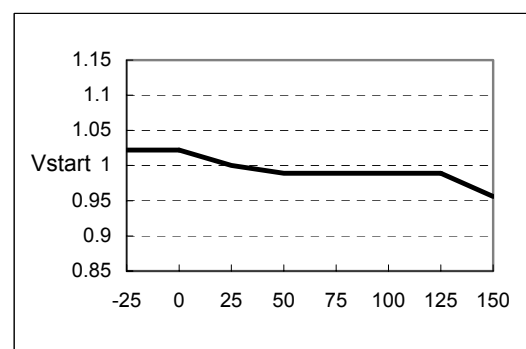

Figure 6. Start Threshold Voltage

Typical Performance Characteristics (Continued)

(These characteristic graphs are normalized at $T_a=25^\circ\text{C}$)

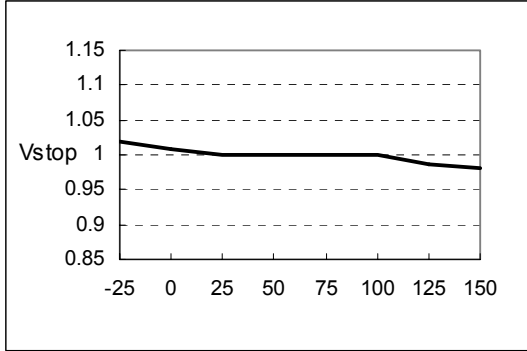

Figure 7. Stop Threshold Voltage

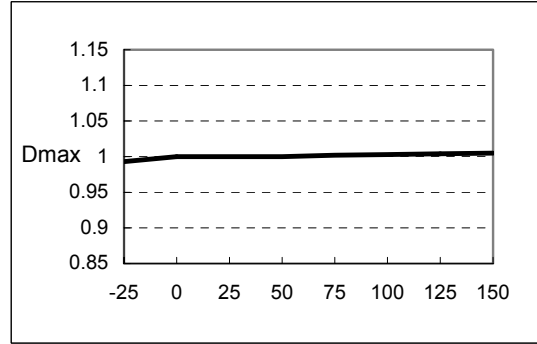

Figure 8. Maximum Duty Cycle

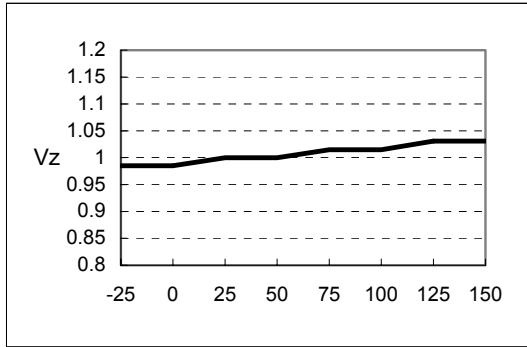

Figure 9. VCC Zener Voltage

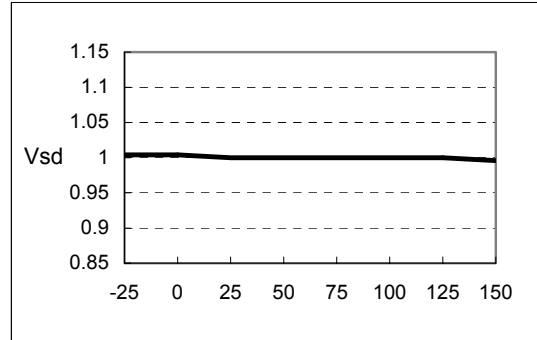

Figure 10. Shutdown Feedback Voltage

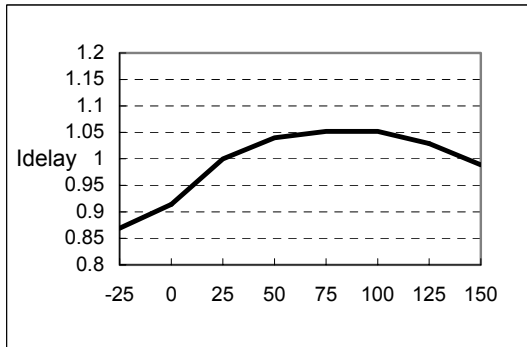

Figure 11. Shutdown Delay Current

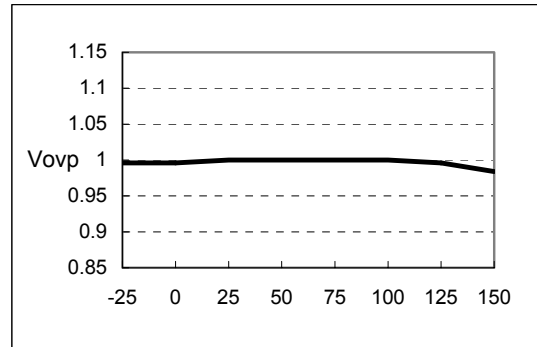

Figure 12. Over Voltage Protection

Typical Performance Characteristics (Continued)

(These characteristic graphs are normalized at $T_a=25^\circ\text{C}$)

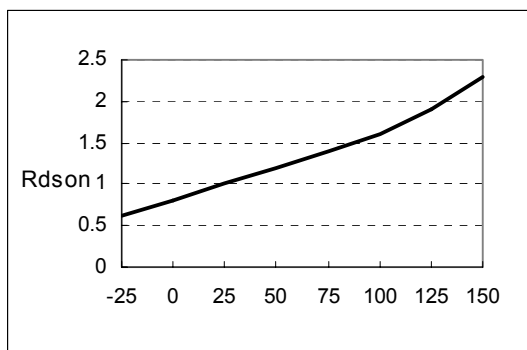
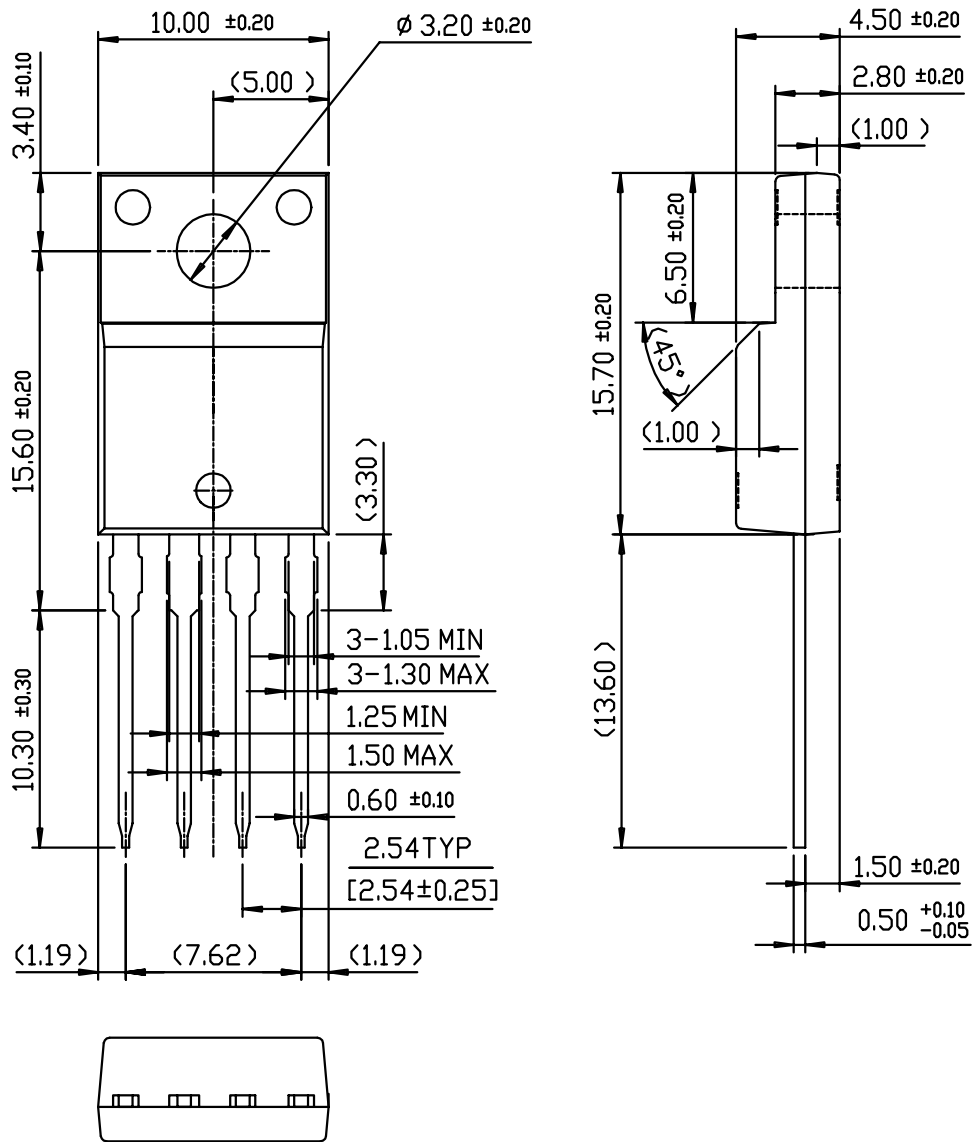

Figure 13. Static Drain-Source on Resistance

Package Dimensions

TO-220F-4L



Ordering Information

Product Number	Package	Rating	Fosc
KA5L0565RTU	TO-220F-4L	650V, 5A	50kHz
KA5L0565RYDTU	TO-220F-4L(Forming)		

TU : Non Forming Type

YDTU : Forming Type

DISCLAIMER

FAIRCHILD SEMICONDUCTOR RESERVES THE RIGHT TO MAKE CHANGES WITHOUT FURTHER NOTICE TO ANY PRODUCTS HEREIN TO IMPROVE RELIABILITY, FUNCTION OR DESIGN. FAIRCHILD DOES NOT ASSUME ANY LIABILITY ARISING OUT OF THE APPLICATION OR USE OF ANY PRODUCT OR CIRCUIT DESCRIBED HEREIN; NEITHER DOES IT CONVEY ANY LICENSE UNDER ITS PATENT RIGHTS, NOR THE RIGHTS OF OTHERS.

LIFE SUPPORT POLICY

FAIRCHILD'S PRODUCTS ARE NOT AUTHORIZED FOR USE AS CRITICAL COMPONENTS IN LIFE SUPPORT DEVICES OR SYSTEMS WITHOUT THE EXPRESS WRITTEN APPROVAL OF THE PRESIDENT OF FAIRCHILD SEMICONDUCTOR CORPORATION. As used herein:

1. Life support devices or systems are devices or systems which, (a) are intended for surgical implant into the body, or (b) support or sustain life, and (c) whose failure to perform when properly used in accordance with instructions for use provided in the labeling, can be reasonably expected to result in a significant injury of the user.
2. A critical component in any component of a life support device or system whose failure to perform can be reasonably expected to cause the failure of the life support device or system, or to affect its safety or effectiveness.