



Chipsmall Limited consists of a professional team with an average of over 10 year of expertise in the distribution of electronic components. Based in Hongkong, we have already established firm and mutual-benefit business relationships with customers from,Europe,America and south Asia,supplying obsolete and hard-to-find components to meet their specific needs.

With the principle of “Quality Parts,Customers Priority,Honest Operation,and Considerate Service”,our business mainly focus on the distribution of electronic components. Line cards we deal with include Microchip,ALPS,ROHM,Xilinx,Pulse,ON,Everlight and Freescale. Main products comprise IC,Modules,Potentiometer,IC Socket,Relay,Connector.Our parts cover such applications as commercial,industrial, and automotives areas.

We are looking forward to setting up business relationship with you and hope to provide you with the best service and solution. Let us make a better world for our industry!



Contact us

Tel: +86-755-8981 8866 Fax: +86-755-8427 6832

Email & Skype: info@chipsmall.com Web: www.chipsmall.com

Address: A1208, Overseas Decoration Building, #122 Zhenhua RD., Futian, Shenzhen, China



KA7632/KA7633

Fixed Multi-output Regulator

Features

- Output Currents up to 0.5A (output1 & 2)
- Output Current up to 1A with External Transistor (output3)
- Fixed Precision Output 1 voltage $3.3V \pm 2\%$
- Fixed Precision Output 2 voltage $8V \pm 2\%$ (KA7632)
- Fixed Precision Output 2 voltage $9V \pm 2\%$ (KA7633)
- Control Signal Generator for Output 3 voltage ($5.1V \pm 2\%$)
- Reset Facility for Output Voltage1
- Output 2,3 with Disable by TTL Input
- Current Limit Protection at Each Output
- Thermal Shut Down

Description

The KA7632/KA7633 is a multi-output positive voltage regulator designed to provide fixed precision output voltages of 3.3V, 8V (KA7632) / 9V (KA7633) at current up to 0.5A and 5.1V at current up to 1A with external PNP transistor. An internal reset circuit generates a reset pulse when the output 1 decrease below the regulated value. Output2 & 3 can be disabled by TTL input. Protection features include over voltage protection, short circuit protection and thermal shutdown.

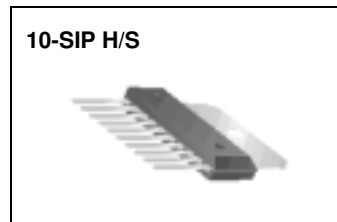

Internal Block Diagram

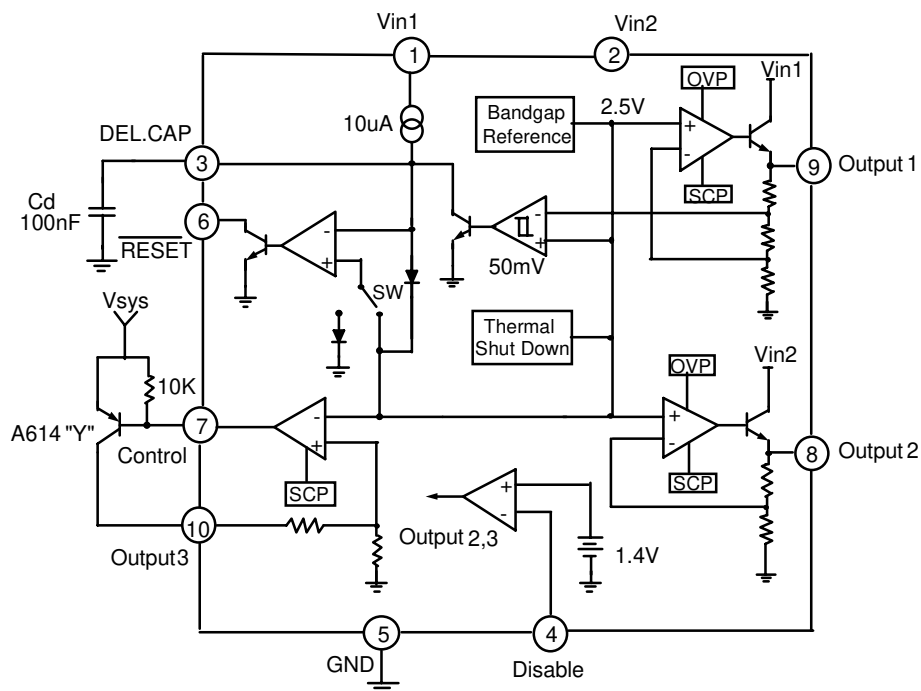

Absolute Maximum Ratings

Parameter	Symbol	Value	Unit	Remark
DC Input Voltage	Vin	20	V	-
Disable Input Voltage	Vc	20	V	-
Output Current	Io	0.5	A	-
Power Dissipation	Pd	1.5	W	No Heatsink
Junction Temperature	Tj	+150	°C	-
Operating Temperature	Topr	0~+125	°C	-

Electrical Characteristics(KA7632)

(Refer to test circuit Vin1=6V , Vin2=10.5V , Tj = +25 °C, unless otherwise specified)

Parameter	Symbol	Conditions	Min.	Typ.	Max.	Unit
Output Voltage 1	Vo1	Io1=10mA 6V<Vin1<14V 5mA<Io1<500mA	3.22 3.14	3.3 3.3	3.38 3.46	V
Output Voltage 2	Vo2	Io2=10mA 10.5V<Vin2<18V 5mA<Io2<500mA	7.84 7.7	8 8	8.16 8.3	V
Dropout Output Voltage 1,2	Vd1,2	Io1,2=500mA	-	-	2.5	V
Line Regulation 1,2	ΔVo 1,2	6V <Vin1<14V 10.5V <Vin2<18V Io1,2 = 200mA	-	-	40 80	mV
Load Regulation 1,2	ΔVo 1,2	5mA < Io1 < 500mA 5mA < Io2 < 500mA	-	-	70 160	mV
Output Voltage 3	Vo3	Vsys=7V, Io3=100mA	4.97	5.1	5.23	V
Line Regulation 3	ΔVo3	13V< Vin2 <18V, Io3 =100mA	-	-	50	mV
Load Regulation 3	ΔVo3	5mA < Io3 < 1A	-	-	110	mV
Reset Pulse Delay	Trd	Cd=100nF, Note1	-	25	-	ms
Saturation Voltage in Reset Condition	VrL	I6=5mA	-	-	0.4	V
Leakage Current at Pin 6	IrH	V6=10V	-	-	10	μA
Output Voltage Thermal Drift	STt	0 °C < Tj < +125 °C , Note 2	-	100	-	ppm/°C
Short Circuit Output Current	Isc1,2	Vin1=6V , Vin2 =10.5V	-	-	1.6	A
Disable Voltage High	VdisH	Output 2 Active	2	-	-	V
Disable Voltage Low	VdisL	Output 2 Disabled	-	-	0.8	V
Disable Bias Current	Idis	0V < Vdis < 7V	-100	-	2	μA
Junction Temperature for TSD	Ttsd	Note 2	-	145	-	°C
Quiescent Current	Iq	Io1=10mA, Output2 Disabled	-	-	2	mA
Reset Threshold Voltage	Vr	K=Vo1	K-0.4	K-0.25	K-0.1	V
Reset Threshold Hysteresis	Vrth	Note 1	20	50	100	mA

Notes:

- To check the reset circuit ,the reset output is low to discharge the delay capacitor(=Cd). if it's less than Vo1-0.25V. And the reset output is high when the delay capacitor voltage linearly increased by the internal current source(10μA) if it's more than Vo1- 0.2V. The equations of delay time is same as below. Trd = (Cd × 2.5) / 10μA
- These parameters, although guaranteed, are not 100% tested in production.

Electrical Characteristics(KA7633)

(Refer to test circuit $V_{in1}=6V$, $V_{in2}=11.5V$, $T_j = +25\text{ }^\circ\text{C}$, unless otherwise specified)

Parameter	Symbol	Conditions	Min.	Typ.	Max.	Unit
Output Voltage 1	V_{o1}	$I_{o1}=10\text{mA}$ $6V < V_{in1} < 14V$ $5\text{mA} < I_{o1} < 500\text{mA}$	3.22 3.14	3.3 3.3	3.38 3.46	V
Output Voltage 2	V_{o2}	$I_{o2}=10\text{mA}$ $11.5V < V_{in2} < 18V$ $5\text{mA} < I_{o2} < 500\text{mA}$	8.82 8.65	9 9	9.18 9.35	V
Dropout Output Voltage 1,2	$V_{d1,2}$	$I_{o1,2}=500\text{mA}$	-	-	2.5	V
Line Regulation 1,2	$\Delta V_{o1,2}$	$6V < V_{in1} < 14V$ $11.5V < V_{in2} < 18V$ $I_{o1,2} = 200\text{mA}$	-	-	40 80	mV
Load Regulation 1,2	$\Delta V_{o1,2}$	$5\text{mA} < I_{o1} < 500\text{mA}$ $5\text{mA} < I_{o2} < 500\text{mA}$	-	-	70 160	mV
Output Voltage 3	V_{o3}	$V_{sys}=7V$, $I_{o3}=100\text{mA}$	4.97	5.1	5.23	V
Line Regulation 3	ΔV_{o3}	$13V < V_{in2} < 18V$, $I_{o3} = 100\text{mA}$	-	-	50	mV
Load Regulation 3	ΔV_{o3}	$5\text{mA} < I_{o3} < 1A$	-	-	110	mV
Reset Pulse Delay	Trd	$C_d=100\text{nF}$, Note1	-	25	-	ms
Saturation Voltage in Reset Condition	V_{rL}	$I_6=5\text{mA}$	-	-	0.4	V
Leakage Current at Pin 6	I_{rH}	$V_6=10V$	-	-	10	μA
Output Voltage Thermal Drift	STt	$0\text{ }^\circ\text{C} < T_j < +125\text{ }^\circ\text{C}$, Note 2	-	100	-	ppm/ $^\circ\text{C}$
Short Circuit Output Current	$I_{sc1,2}$	$V_{in1}=6V$, $V_{in2} = 11.5V$	-	-	1.6	A
Disable Voltage High	V_{disH}	Output 2 Active	2	-	-	V
Disable Voltage Low	V_{disL}	Output 2 Disabled	-	-	0.8	V
Disable Bias Current	I_{dis}	$0V < V_{dis} < 7V$	-100	-	2	μA
Junction Temperature for TSD	T_{tsd}	Note 2	-	145	-	$^\circ\text{C}$
Quiescent Current	I_q	$I_{o1}=10\text{mA}$, Output2 Disabled	-	-	2	mA
Reset Threshold Voltage	V_r	$K=V_{o1}$	K-0.4	K-0.25	K-0.1	V
Reset Threshold Hysteresis	V_{rth}	Note 1	20	50	100	mA

Notes:

- To check the reset circuit ,the reset output is low to discharge the delay capacitor(=Cd). if it's less than $V_{o1}-0.25V$. And the reset output is high when the delay capacitor voltage linearly increased by the internal current source($10\mu\text{A}$) if it's more than $V_{o1}-0.2V$. The equations of delay time is same as below. $Trd = (Cd \times 2.5) / 10\mu\text{A}$
- These parameters, although guaranteed, are not 100% tested in production.

Typical Performance Characteristics

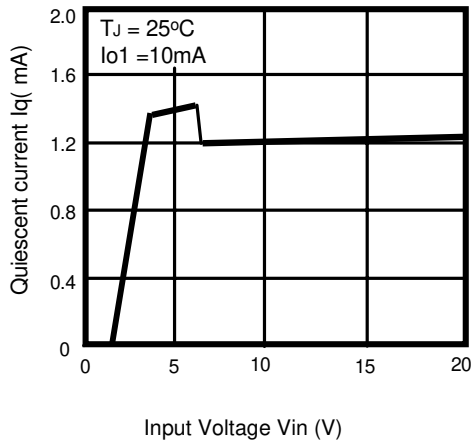

Figure 1. Quiescent Current vs. Input Voltage

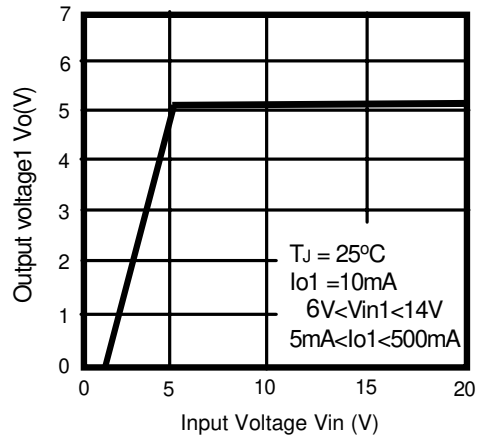

Figure 2. Output Voltage1 vs. Input Voltage

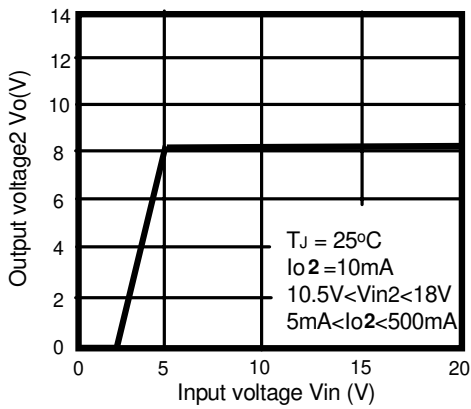

Figure 3. Output Voltage2 vs. Input Voltage

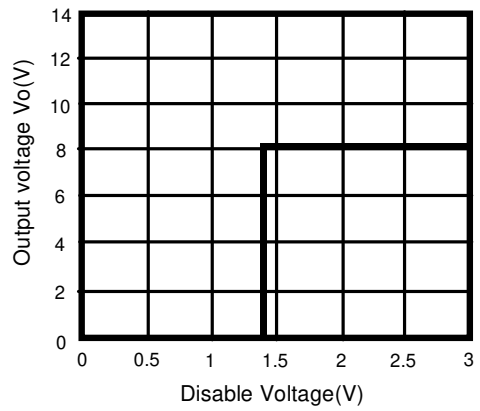

Figure 4. Output Voltage vs. Disable Voltage High(Low)

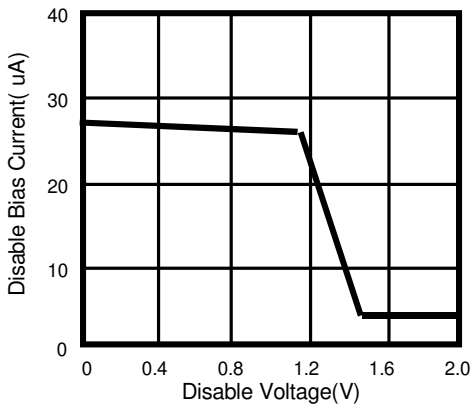

Figure 5. Disable Bias Current vs. Disable Voltage

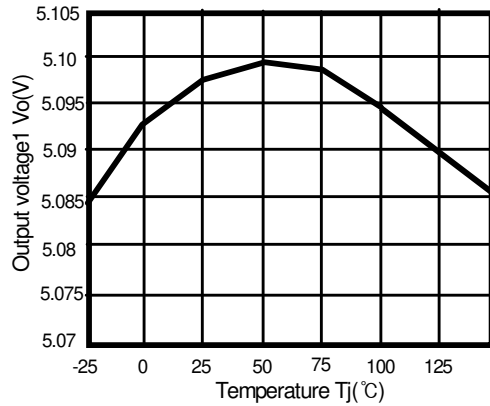

Figure 6. Output Voltage1 vs. Temperature(Tj)

Typical Performance Characteristics (continued)

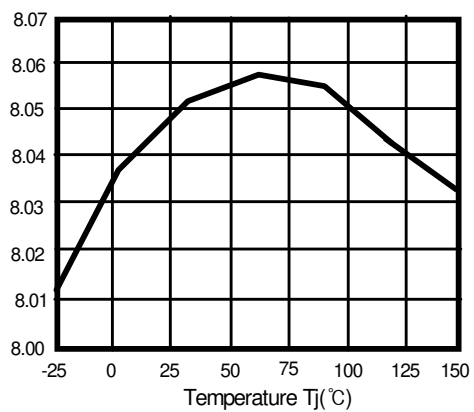

Figure 7. Output Voltage2 vs. Temperature(T_j)

Mechanical Dimensions

Package

Dimensions in millimeters

10-SIP H/S

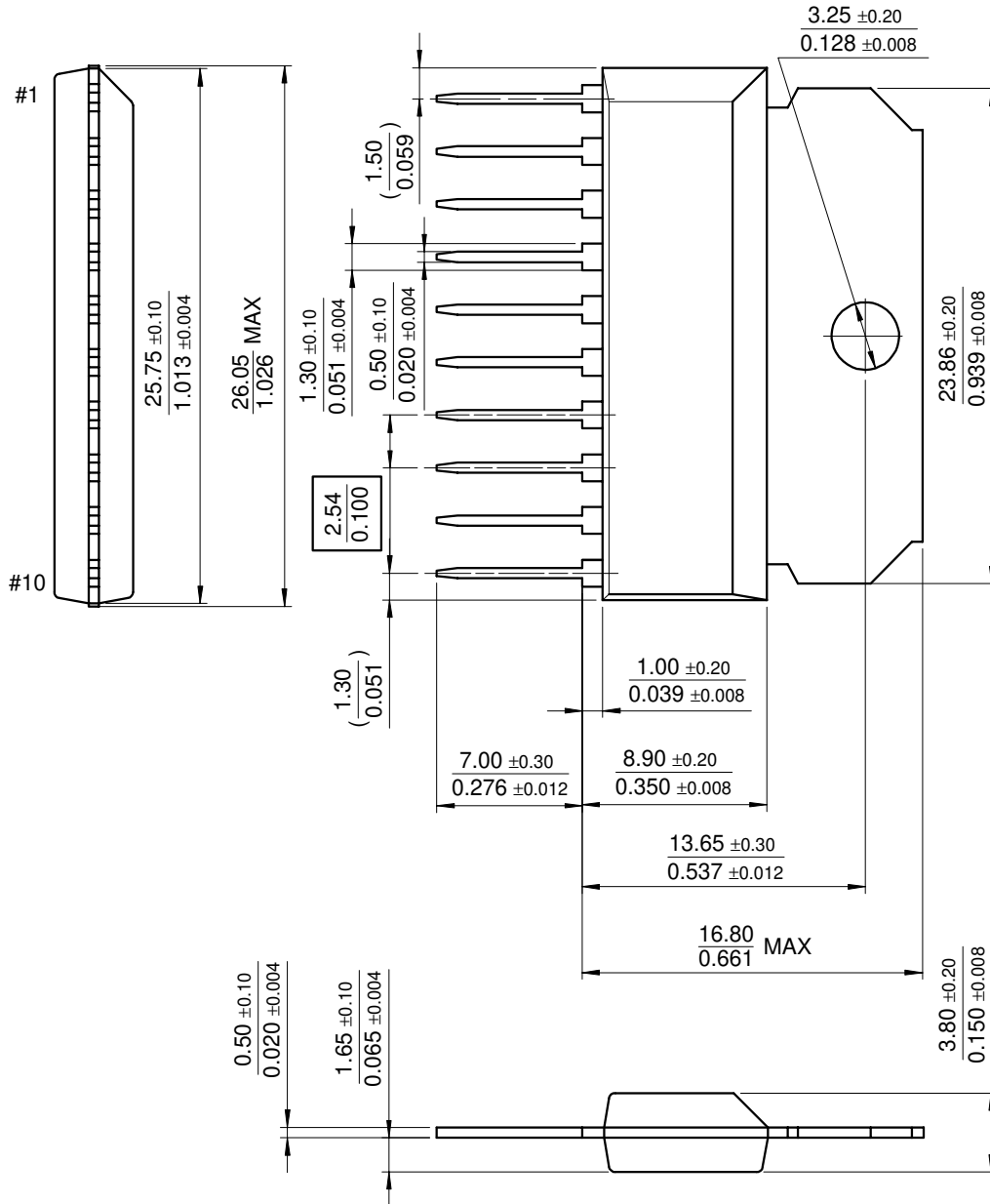

Ordering Information

Product Number	Package	Operating Temperature
KA7632	10-SIP H/S	0°C to +125°C
KA7633		

DISCLAIMER

FAIRCHILD SEMICONDUCTOR RESERVES THE RIGHT TO MAKE CHANGES WITHOUT FURTHER NOTICE TO ANY PRODUCTS HEREIN TO IMPROVE RELIABILITY, FUNCTION OR DESIGN. FAIRCHILD DOES NOT ASSUME ANY LIABILITY ARISING OUT OF THE APPLICATION OR USE OF ANY PRODUCT OR CIRCUIT DESCRIBED HEREIN; NEITHER DOES IT CONVEY ANY LICENSE UNDER ITS PATENT RIGHTS, NOR THE RIGHTS OF OTHERS.

LIFE SUPPORT POLICY

FAIRCHILD'S PRODUCTS ARE NOT AUTHORIZED FOR USE AS CRITICAL COMPONENTS IN LIFE SUPPORT DEVICES OR SYSTEMS WITHOUT THE EXPRESS WRITTEN APPROVAL OF THE PRESIDENT OF FAIRCHILD SEMICONDUCTOR CORPORATION. As used herein:

1. Life support devices or systems are devices or systems which, (a) are intended for surgical implant into the body, or (b) support or sustain life, and (c) whose failure to perform when properly used in accordance with instructions for use provided in the labeling, can be reasonably expected to result in a significant injury of the user.
2. A critical component in any component of a life support device or system whose failure to perform can be reasonably expected to cause the failure of the life support device or system, or to affect its safety or effectiveness.