



Chipsmall Limited consists of a professional team with an average of over 10 year of expertise in the distribution of electronic components. Based in Hongkong, we have already established firm and mutual-benefit business relationships with customers from,Europe,America and south Asia,supplying obsolete and hard-to-find components to meet their specific needs.

With the principle of “Quality Parts,Customers Priority,Honest Operation,and Considerate Service”,our business mainly focus on the distribution of electronic components. Line cards we deal with include Microchip,ALPS,ROHM,Xilinx,Pulse,ON,Everlight and Freescale. Main products comprise IC,Modules,Potentiometer,IC Socket,Relay,Connector.Our parts cover such applications as commercial,industrial, and automotives areas.

We are looking forward to setting up business relationship with you and hope to provide you with the best service and solution. Let us make a better world for our industry!



Contact us

Tel: +86-755-8981 8866 Fax: +86-755-8427 6832

Email & Skype: info@chipsmall.com Web: www.chipsmall.com

Address: A1208, Overseas Decoration Building, #122 Zhenhua RD., Futian, Shenzhen, China



KAI-02150

1920 (H) x 1080 (V) Interline CCD Image Sensor

Description

The KAI-02150 Image Sensor is a 1080p (1920 × 1080) CCD in a 2/3" optical format. Based on the TRUESENSE 5.5-micron Interline Transfer CCD Platform, the sensor features broad dynamic range, excellent imaging performance, and a flexible readout architecture that enables use of 1, 2, or 4 outputs for full resolution readout up to 64 frames per second. A vertical overflow drain structure suppresses image blooming and enables electronic shuttering for precise exposure control.

Table 1. GENERAL SPECIFICATIONS

Parameter	Typical Value
Architecture	Interline CCD, Progressive Scan
Total Number of Pixels	2004 (H) × 1144 (V)
Number of Effective Pixels	1960 (H) × 1120 (V)
Number of Active Pixels	1920 (H) × 1080 (V)
Pixel Size	5.5 μm (H) × 5.5 μm (V)
Active Image Size	10.56 mm (H) × 5.94 mm (V) 12.1 mm (Diagonal), 2/3" Optical Format
Aspect Ratio	16:9
Number of Outputs	1, 2, or 4
Charge Capacity	20,000 electrons
Output Sensitivity	34 μV/e ⁻
Quantum Efficiency Pan (-ABA, -PBA) R, G, B (-FBA, -QBA) R, G, B (-CBA, -PBA)	44% 31%, 37%, 38% 29%, 37%, 39%
Base ISO KAI-02150-ABA KAI-02150-FBA KAI-02150-CBA KAI-02150-PBA	330 170 150 330
Read Noise (f = 40 MHz)	12 e ⁻ rms
Dark Current Photodiode/VCCD	7/100 e ⁻ /s
Dark Current Doubling Temp Photodiode/VCCD	7°C/9°C
Dynamic Range	64 dB
Charge Transfer Efficiency	0.999999
Blooming Suppression	> 300 X
Smear	-100 dB
Image Lag	< 10 electrons
Maximum Pixel Clock Speed	40 MHz
Maximum Frame Rate Quad/Dual/Single Output	64/33/17 fps
Package	68 Pin PGA 64 Pin CLCC
Cover Glass	AR Coated, 2-Sides or Clear Glass

NOTE: All Parameters are specified at T = 40°C unless otherwise noted.



ON Semiconductor®

www.onsemi.com

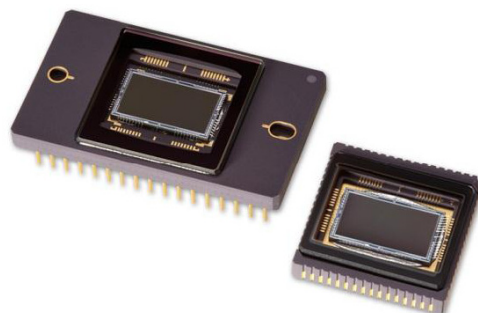

Figure 1. KAI-02150 Interline CCD Image Sensor

Features

- Bayer Color Pattern, TRUESENSE Sparse Color Filter Pattern, and Monochrome Configurations
- Progressive Scan Readout
- Flexible Readout Architecture
- High Frame Rate
- High Sensitivity
- Low Noise Architecture
- Excellent Smear Performance
- Package Pin Reserved for Device Identification

Applications

- Industrial Imaging
- Medical Imaging
- Security

ORDERING INFORMATION

See detailed ordering and shipping information on page 2 of this data sheet.

KAI-02150

The sensor is available with the TRUESENSE Sparse Color Filter Pattern, a technology which provides a 2x improvement in light sensitivity compared to a standard color Bayer part.

The sensor shares common PGA pin-out and electrical configurations with other devices based on the TRUESENSE 5.5 micron Interline Transfer CCD Platform, allowing a single camera design to support multiple members of this sensor family.

ORDERING INFORMATION

Standard Devices

See full datasheet for ordering information associated with devices no longer recommended for new designs.

Table 2. ORDERING INFORMATION – STANDARD DEVICES

Part Number	Description	Marking Code
KAI-02150-AAA-JP-BA	Monochrome, No Microlens, PGA Package, Taped Clear Cover Glass, No Coatings, Standard Grade.	KAI-02150-AAA Serial Number
KAI-02150-AAA-JP-AE	Monochrome, No Microlens, PGA Package, Taped Clear Cover Glass, No Coatings, Engineering Grade.	
KAI-02150-ABA-JD-BA	Monochrome, Telecentric Microlens, PGA Package, Sealed Clear Cover Glass with AR Coating (Both Sides), Standard Grade.	KAI-02150-ABA Serial Number
KAI-02150-ABA-JD-AE	Monochrome, Telecentric Microlens, PGA Package, Sealed Clear Cover Glass with AR Coating (Both Sides), Engineering Grade.	
KAI-02150-ABA-JP-BA	Monochrome, Telecentric Microlens, PGA Package, Taped Clear Cover Glass, No Coatings, Standard Grade.	
KAI-02150-ABA-JP-AE	Monochrome, Telecentric Microlens, PGA Package, Taped Clear Cover Glass, No Coatings, Engineering Grade.	
KAI-02150-ABA-FD-BA	Monochrome, Telecentric Microlens, CLCC Package, Sealed Clear Cover Glass with AR Coating (Both Sides), Standard Grade.	
KAI-02150-ABA-FD-AE	Monochrome, Telecentric Microlens, CLCC Package, Sealed Clear Cover Glass with AR Coating (Both Sides), Engineering Grade.	
KAI-02150-FBA-JD-BA	Gen2 Color (Bayer RGB), Telecentric Microlens, PGA Package, Sealed Clear Cover Glass with AR Coating (Both Sides), Standard Grade.	KAI-02150-FBA Serial Number
KAI-02150-FBA-JD-AE	Gen2 Color (Bayer RGB), Telecentric Microlens, PGA Package, Sealed Clear Cover Glass with AR Coating (Both Sides), Engineering Grade.	
KAI-02150-FBA-FD-BA	Gen2 Color (Bayer RGB), Telecentric Microlens, CLCC Package, Sealed Clear Cover Glass with AR Coating (Both Sides), Standard Grade.	
KAI-02150-FBA-FD-AE	Gen2 Color (Bayer RGB), Telecentric Microlens, CLCC Package, Sealed Clear Cover Glass with AR Coating (Both Sides), Engineering Grade.	
KAI-02150-FBA-JB-B2	Gen2 Color (Bayer RGB), Telecentric Microlens, PGA Package, Sealed Clear Cover Glass (No Coatings), Grade 2.	KAI-02150-FBA Serial Number V _{AB} = xx.x
KAI-02150-FBA-JB-AE	Gen2 Color (Bayer RGB), Telecentric Microlens, PGA Package, Sealed Clear Cover Glass (No Coatings), Engineering Grade.	
KAI-02150-FBA-JB-B2-T	Gen2 Color (Bayer RGB), Telecentric Microlens, PGA Package, Sealed Clear Cover Glass (No Coatings), Grade 2, Packed in Trays.	
KAI-02150-QBA-JD-BA	Gen2 Color (TRUESENSE Sparse CFA), Telecentric Microlens, PGA Package, Sealed Clear Cover Glass with AR Coating (Both Sides), Standard Grade.	KAI-02150-QBA Serial Number
KAI-02150-QBA-JD-AE	Gen2 Color (TRUESENSE Sparse CFA), Telecentric Microlens, PGA Package, Sealed Clear Cover Glass with AR Coating (Both Sides), Engineering Grade.	
KAI-02150-QBA-FD-BA	Gen2 Color (TRUESENSE Sparse CFA), Telecentric Microlens, CLCC Package, Sealed Clear Cover Glass with AR Coating (Both Sides), Standard Grade.	
KAI-02150-QBA-FD-AE	Gen2 Color (TRUESENSE Sparse CFA), Telecentric Microlens, CLCC Package, Sealed Clear Cover Glass with AR Coating (Both Sides), Engineering Grade.	

See the ON Semiconductor *Device Nomenclature* document (TND310/D) for a full description of the naming convention used for image sensors. For reference documentation, including information on evaluation kits, please visit our web site at www.onsemi.com.

KAI-02150

Not Recommended for New Designs

Table 3. ORDERING INFORMATION – NOT RECOMMENDED FOR NEW DESIGNS

Part Number	Description	Marking Code
KAI-02150-CBA-JD-BA	Gen1 Color (Bayer RGB), Telecentric Microlens, PGA Package, Sealed Clear Cover Glass with AR Coating (Both Sides), Standard Grade.	KAI-02150-CBA Serial Number
KAI-02150-CBA-JD-AE	Gen1 Color (Bayer RGB), Telecentric Microlens, PGA Package, Sealed Clear Cover Glass with AR Coating (Both Sides), Engineering Grade.	
KAI-02150-CBA-FD-BA	Gen1 Color (Bayer RGB), Telecentric Microlens, CLCC Package, Sealed Clear Cover Glass with AR Coating (Both Sides), Standard Grade.	
KAI-02150-CBA-FD-AE	Gen1 Color (Bayer RGB), Telecentric Microlens, CLCC Package, Sealed Clear Cover Glass with AR Coating (Both Sides), Engineering Grade.	
KAI-02150-CBA-JB-B2	Gen1 Color (Bayer RGB), Telecentric Microlens, PGA Package, Sealed Clear Cover Glass (No Coatings), Grade 2.	KAI-02150-CBA Serial Number V _{AB} = xx.x
KAI-02150-CBA-JB-AE	Gen1 Color (Bayer RGB), Telecentric Microlens, PGA Package, Sealed Clear Cover Glass (No Coatings), Engineering Grade.	
KAI-02150-CBA-JB-B2-T	Gen1 Color (Bayer RGB), Telecentric Microlens, PGA Package, Sealed Clear Cover Glass (No Coatings), Grade 2, Packed in Trays.	
KAI-02150-PBA-JD-BA	Gen1 Color (TRUESENSE Sparse CFA), Telecentric Microlens, PGA Package, Sealed Clear Cover Glass with AR Coating (Both Sides), Standard Grade.	KAI-02150-PBA Serial Number
KAI-02150-PBA-JD-AE	Gen1 Color (TRUESENSE Sparse CFA), Telecentric Microlens, PGA Package, Sealed Clear Cover Glass with AR Coating (Both Sides), Engineering Grade.	
KAI-02150-PBA-FD-BA	Gen1 Color (TRUESENSE Sparse CFA), Telecentric Microlens, CLCC Package, Sealed Clear Cover Glass with AR Coating (Both Sides), Standard Grade.	
KAI-02150-PBA-FD-AE	Gen1 Color (TRUESENSE Sparse CFA), Telecentric Microlens, CLCC Package, Sealed Clear Cover Glass with AR Coating (Both Sides), Engineering Grade.	

DEVICE DESCRIPTION

Architecture

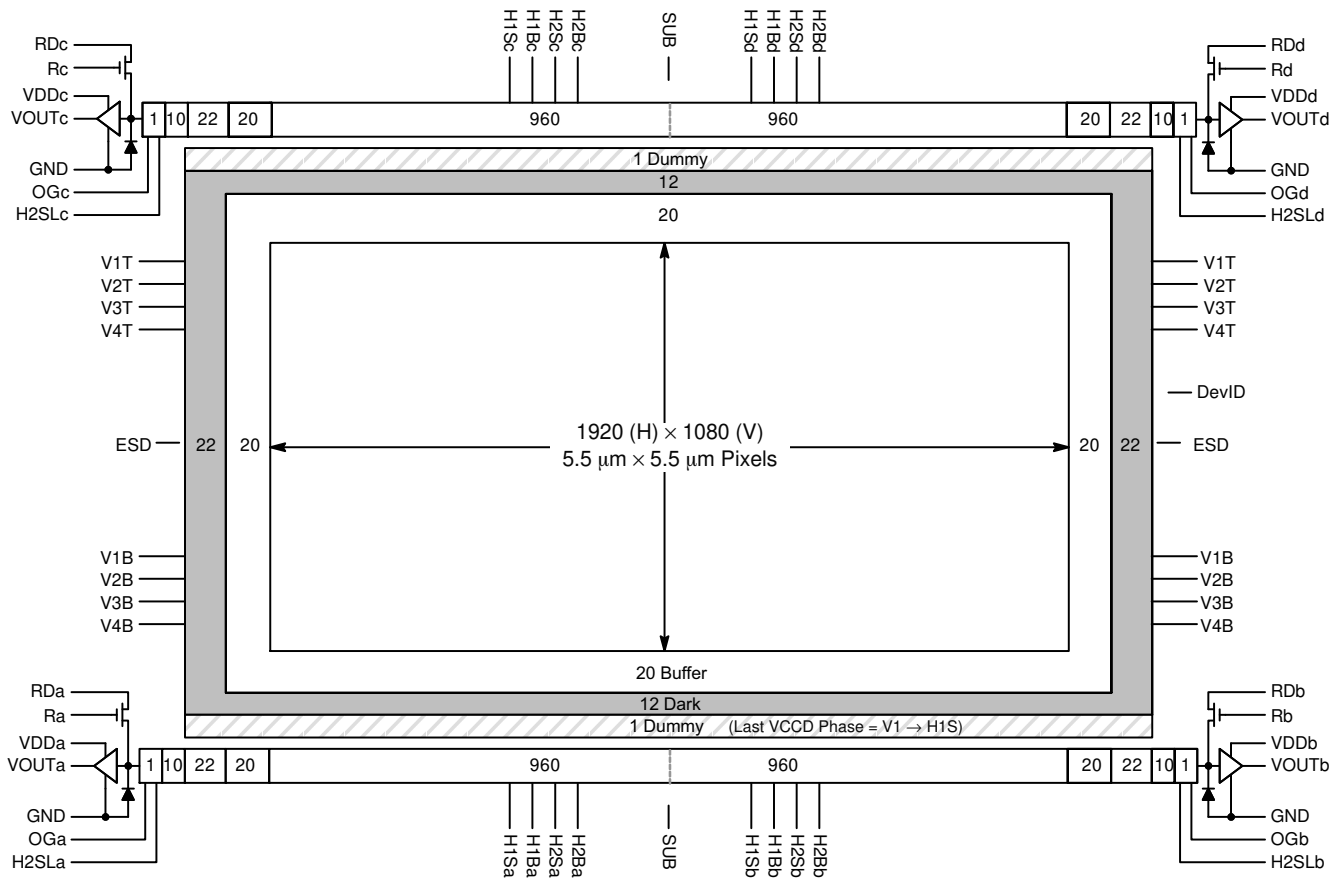

Figure 2. Block Diagram

Dark Reference Pixels

There are 12 dark reference rows at the top and 12 dark rows at the bottom of the image sensor. The dark rows are not entirely dark and so should not be used for a dark reference level. Use the 22 dark columns on the left or right side of the image sensor as a dark reference.

Under normal circumstances use only the center 20 columns of the 22 column dark reference due to potential light leakage.

Dummy Pixels

Within each horizontal shift register there are 11 leading additional shift phases. These pixels are designated as dummy pixels and should not be used to determine a dark reference level.

In addition, there is one dummy row of pixels at the top and bottom of the image.

Active Buffer Pixels

20 unshielded pixels adjacent to any leading or trailing dark reference regions are classified as active buffer pixels.

These pixels are light sensitive but are not tested for defects and non-uniformities.

Image Acquisition

An electronic representation of an image is formed when incident photons falling on the sensor plane create electron-hole pairs within the individual silicon photodiodes. These photoelectrons are collected locally by the formation of potential wells at each photosite. Below photodiode saturation, the number of photoelectrons collected at each pixel is linearly dependent upon light level and exposure time and non-linearly dependent on wavelength. When the photodiodes charge capacity is reached, excess electrons are discharged into the substrate to prevent blooming.

ESD Protection

Adherence to the power-up and power-down sequence is critical. Failure to follow the proper power-up and power-down sequences may cause damage to the sensor. See Power-Up and Power-Down Sequence section.

Bayer Color Filter Pattern

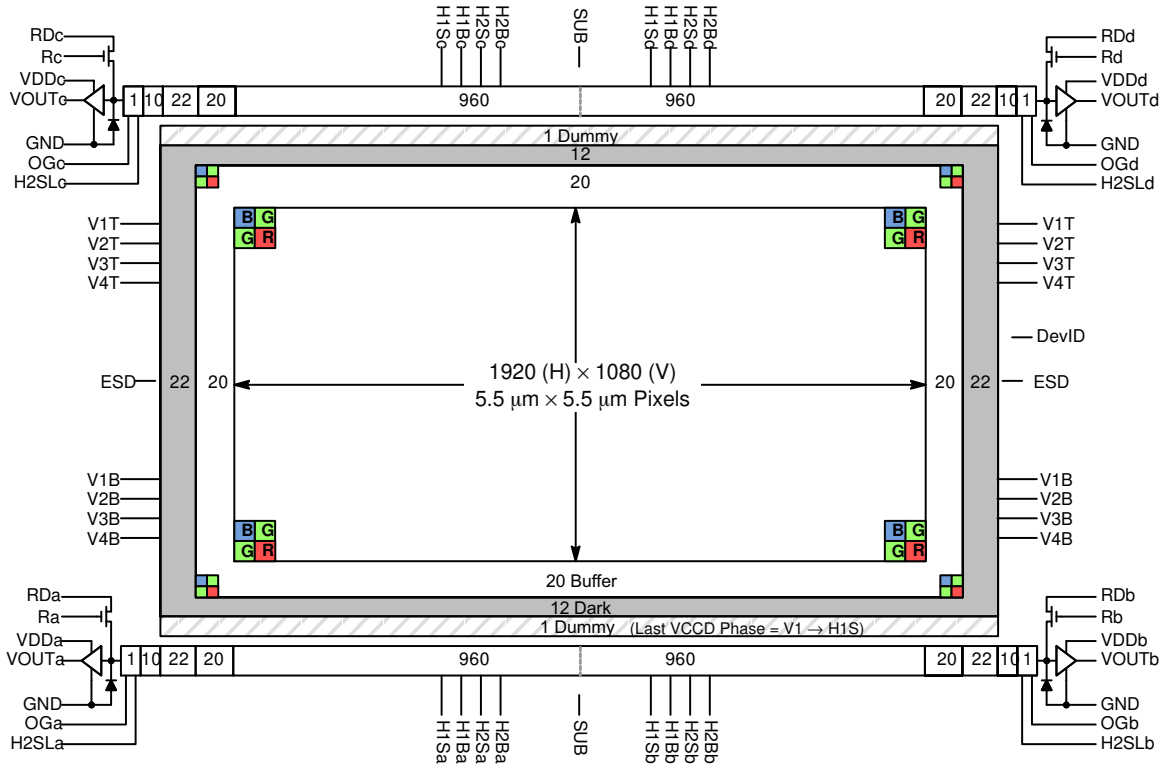

Figure 3. Bayer Color Filter Pattern

TRUESENSE Sparse Color Filter Pattern

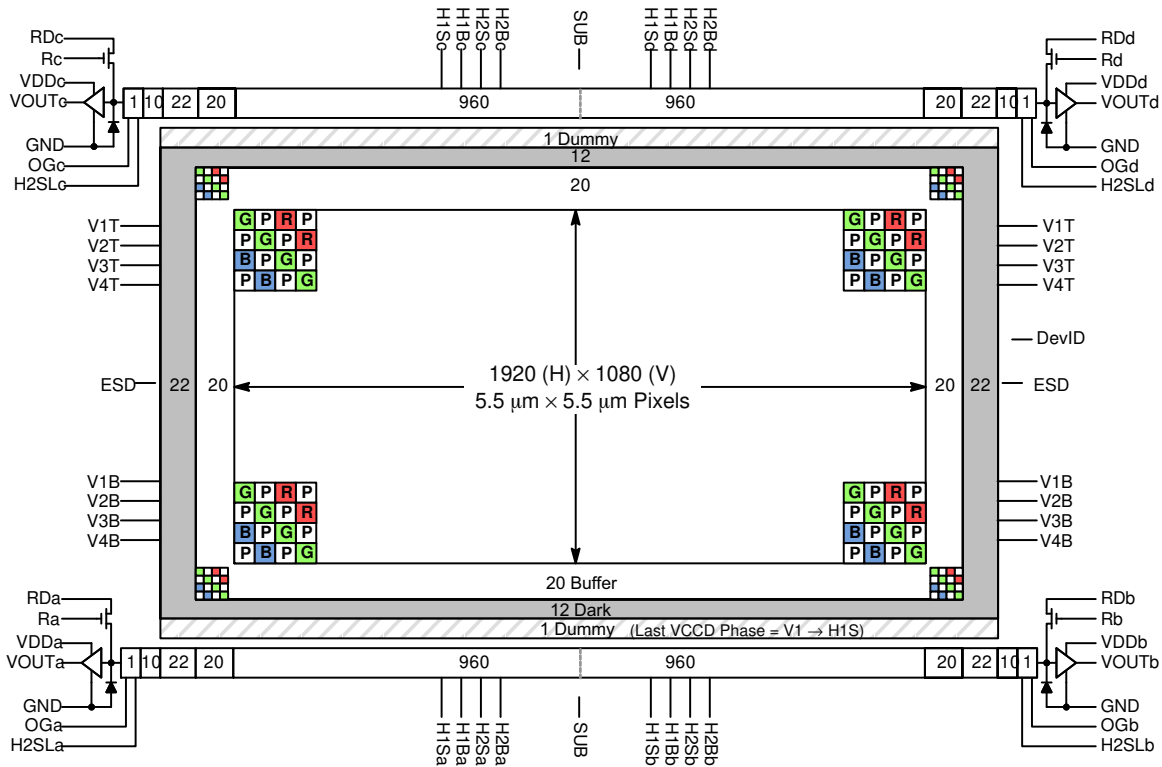

Figure 4. TRUESENSE Sparse Color Filter Pattern

Physical Description

Pin Grid Array Pin Description

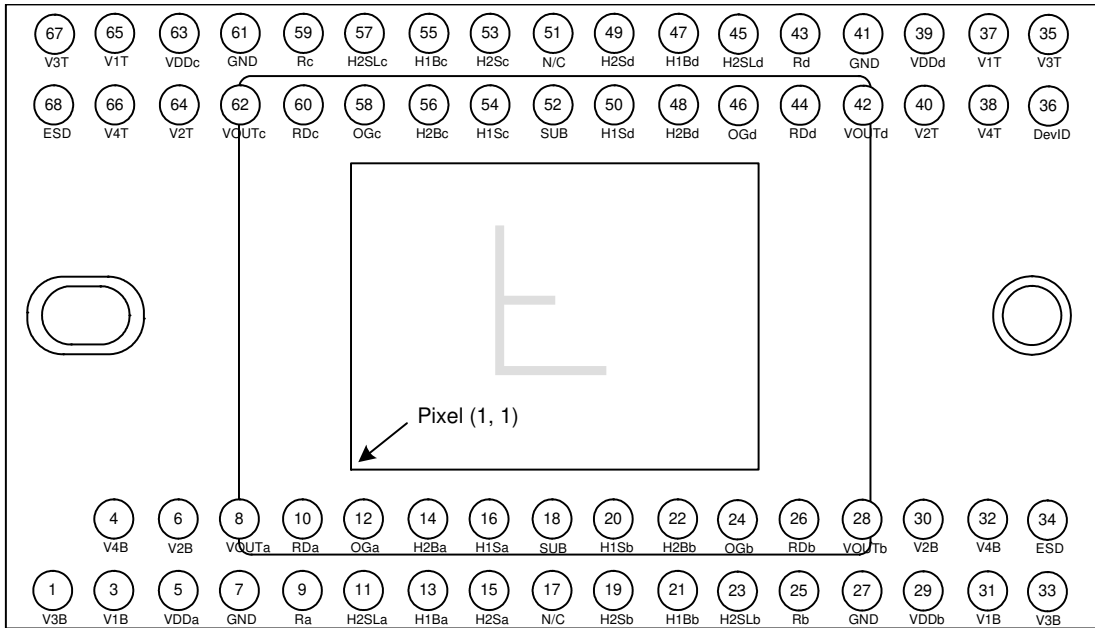

Figure 5. PGA Package Pin Designations – Top View

Table 4. PGA PACKAGE PIN DESCRIPTION

Pin	Name	Description
1	V3B	Vertical CCD Clock, Phase 3, Bottom
3	V1B	Vertical CCD Clock, Phase 1, Bottom
4	V4B	Vertical CCD Clock, Phase 4, Bottom
5	VDDa	Output Amplifier Supply, Quadrant a
6	V2B	Vertical CCD Clock, Phase 2, Bottom
7	GND	Ground
8	VOUa	Video Output, Quadrant a
9	Ra	Reset Gate, Quadrant a
10	RDa	Reset Drain, Quadrant a
11	H2SLa	Horizontal CCD Clock, Phase 2, Storage, Last Phase, Quadrant a
12	OGa	Output Gate, Quadrant a
13	H1Ba	Horizontal CCD Clock, Phase 1, Barrier, Quadrant a
14	H2Ba	Horizontal CCD Clock, Phase 2, Barrier, Quadrant a
15	H2Sa	Horizontal CCD Clock, Phase 2, Storage, Quadrant a
16	H1Sa	Horizontal CCD Clock, Phase 1, Storage, Quadrant a
17	N/C	No Connect
18	SUB	Substrate
19	H2Sb	Horizontal CCD Clock, Phase 2, Storage, Quadrant b
20	H1Sb	Horizontal CCD Clock, Phase 1, Storage, Quadrant b
21	H1Bb	Horizontal CCD Clock, Phase 1, Barrier, Quadrant b
22	H2Bb	Horizontal CCD Clock, Phase 2, Barrier, Quadrant b
23	H2SLb	Horizontal CCD Clock, Phase 1, Storage, Last Phase, Quadrant b
24	OGb	Output Gate, Quadrant b

KAI-02150

Table 4. PGA PACKAGE PIN DESCRIPTION (continued)

Pin	Name	Description
25	Rb	Reset Gate, Quadrant b
26	RDb	Reset Drain, Quadrant b
27	GND	Ground
28	VOUtb	Video Output, Quadrant b
29	VDDb	Output Amplifier Supply, Quadrant b
30	V2B	Vertical CCD Clock, Phase 2, Bottom
31	V1B	Vertical CCD Clock, Phase 1, Bottom
32	V4B	Vertical CCD Clock, Phase 4, Bottom
33	V3B	Vertical CCD Clock, Phase 3, Bottom
34	ESD	ESD Protection Disable
35	V3T	Vertical CCD Clock, Phase 3, Top
36	DevID	Device Identification
37	V1T	Vertical CCD Clock, Phase 1, Top
38	V4T	Vertical CCD Clock, Phase 4, Top
39	VDDd	Output Amplifier Supply, Quadrant d
40	V2T	Vertical CCD Clock, Phase 2, Top
41	GND	Ground
42	VOUtd	Video Output, Quadrant d
43	Rd	Reset Gate, Quadrant d
44	RDd	Reset Drain, Quadrant d
45	H2SLd	Horizontal CCD Clock, Phase 2, Storage, Last Phase, Quadrant d
46	OGd	Output Gate, Quadrant d
47	H1Bd	Horizontal CCD Clock, Phase 1, Barrier, Quadrant d
48	H2Bd	Horizontal CCD Clock, Phase 2, Barrier, Quadrant d
49	H2Sd	Horizontal CCD Clock, Phase 2, Storage, Quadrant d
50	H1Sd	Horizontal CCD Clock, Phase 1, Storage, Quadrant d
51	N/C	No Connect
52	SUB	Substrate
53	H2Sc	Horizontal CCD Clock, Phase 2, Storage, Quadrant c
54	H1Sc	Horizontal CCD Clock, Phase 1, Storage, Quadrant c
55	H1Bc	Horizontal CCD Clock, Phase 1, Barrier, Quadrant c
56	H2Bc	Horizontal CCD Clock, Phase 2, Barrier, Quadrant c
57	H2SLc	Horizontal CCD Clock, Phase 2, Storage, Last Phase, Quadrant c
58	OGc	Output Gate, Quadrant c
59	Rc	Reset Gate, Quadrant c
60	RDc	Reset Drain, Quadrant c
61	GND	Ground
62	VOUtc	Video Output, Quadrant c
63	VDDc	Output Amplifier Supply, Quadrant c
64	V2T	Vertical CCD Clock, Phase 2, Top
65	V1T	Vertical CCD Clock, Phase 1, Top
66	V4T	Vertical CCD Clock, Phase 4, Top
67	V3T	Vertical CCD Clock, Phase 3, Top
68	ESD	EDS Protection Disable

1. Liked named pins are internally connected and should have a common drive signal.
2. N/C pins (17, 51) should be left floating.

KAI-02150

Ceramic Leadless Chip Carrier Pin Description

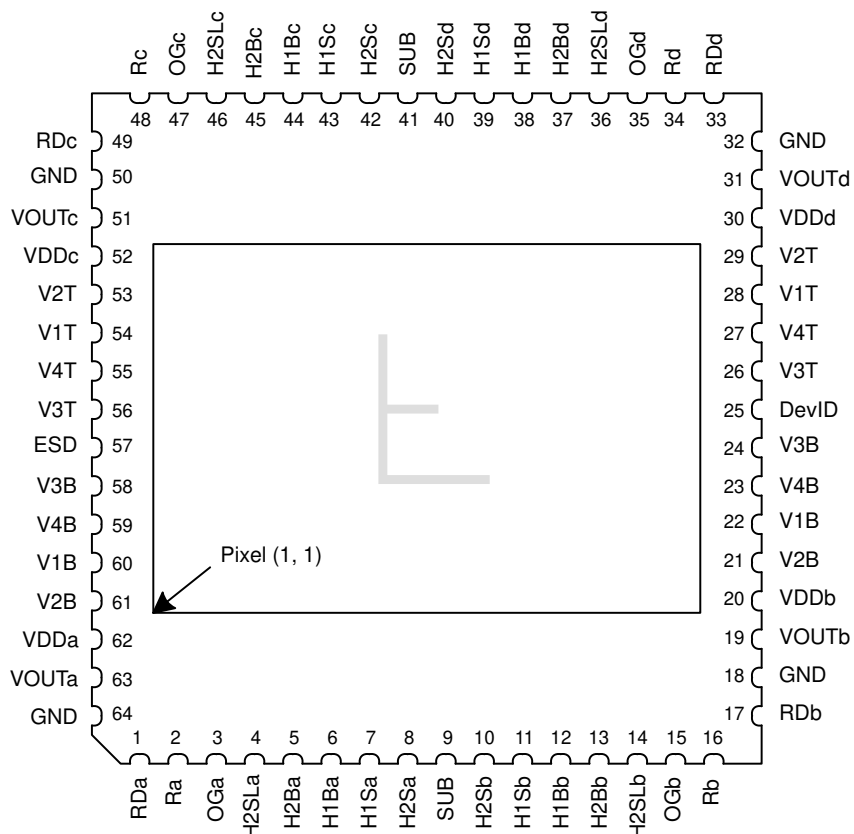

Figure 6. CLCC Package Pin Designations – Top View

Table 5. CLCC PACKAGE PIN DESCRIPTION

Pin	Name	Description
1	RDa	Reset Drain, Quadrant a
2	Ra	Reset Gate, Quadrant a
3	OGa	Output Gate, Quadrant a
4	H2SLa	Horizontal CCD Clock, Phase 2, Storage, Last Phase, Quadrant a
5	H2Ba	Horizontal CCD Clock, Phase 2, Barrier, Quadrant a
6	H1Ba	Horizontal CCD Clock, Phase 1, Barrier, Quadrant a
7	H1Sa	Horizontal CCD Clock, Phase 1, Storage, Quadrant a
8	H2Sa	Horizontal CCD Clock, Phase 2, Storage, Quadrant a
9	SUB	Substrate
10	H2Sb	Horizontal CCD Clock, Phase 2, Storage, Quadrant b
11	H1Sb	Horizontal CCD Clock, Phase 1, Storage, Quadrant b
12	H1Bb	Horizontal CCD Clock, Phase 1, Barrier, Quadrant b
13	H2Bb	Horizontal CCD Clock, Phase 2, Barrier, Quadrant b
14	H2SLb	Horizontal CCD Clock, Phase 2, Storage, Last Phase, Quadrant b
15	OGb	Output Gate, Quadrant b
16	Rb	Reset Gate, Quadrant b
17	RDb	Reset Drain, Quadrant b
18	GND	Ground
19	VOUTb	Video Output, Quadrant b

KAI-02150

Table 5. CLCC PACKAGE PIN DESCRIPTION (continued)

Pin	Name	Description
20	VDDb	Output Amplifier Supply, Quadrant b
21	V2B	Vertical CCD Clock, Phase 2, Bottom
22	V1B	Vertical CCD Clock, Phase 1, Bottom
23	V4B	Vertical CCD Clock, Phase 4, Bottom
24	V3B	Vertical CCD Clock, Phase 3, Bottom
25	DevID	Device Identification
26	V3T	Vertical CCD Clock, Phase 3, Top
27	V4T	Vertical CCD Clock, Phase 4, Top
28	V1T	Vertical CCD Clock, Phase 1, Top
29	V2T	Vertical CCD Clock, Phase 2, Top
30	VDDd	Output Amplifier Supply, Quadrant d
31	VOUtd	Video Output, Quadrant d
32	GND	Ground
33	RDd	Reset Drain, Quadrant d
34	Rd	Reset Gate, Quadrant d
35	OGd	Output Gate, Quadrant d
36	H2SLd	Horizontal CCD Clock, Phase 2, Storage, Last Phase, Quadrant d
37	H2Bd	Horizontal CCD Clock, Phase 2, Barrier, Quadrant d
38	H1Bd	Horizontal CCD Clock, Phase 1, Barrier, Quadrant d
39	H1Sd	Horizontal CCD Clock, Phase 1, Storage, Quadrant d
40	H2Sd	Horizontal CCD Clock, Phase 2, Storage, Quadrant d
41	SUB	Substrate
42	H2Sc	Horizontal CCD Clock, Phase 2, Storage, Quadrant c
43	H1Sc	Horizontal CCD Clock, Phase 1, Storage, Quadrant c
44	H1Bc	Horizontal CCD Clock, Phase 1, Barrier, Quadrant c
45	H2Bc	Horizontal CCD Clock, Phase 2, Barrier, Quadrant c
46	H2SLc	Horizontal CCD Clock, Phase 2, Storage, Last Phase, Quadrant c
47	OGc	Output Gate, Quadrant c
48	Rc	Reset Gate, Quadrant c
49	RDc	Reset Drain, Quadrant c
50	GND	Ground
51	VOUtc	Video Output, Quadrant c
52	VDDc	Output Amplifier Supply, Quadrant c
53	V2T	Vertical CCD Clock, Phase 2, Top
54	V1T	Vertical CCD Clock, Phase 1, Top
55	V4T	Vertical CCD Clock, Phase 4, Top
56	V3T	Vertical CCD Clock, Phase 3, Top
57	ESD	ESD Protection Disable
58	V3B	Vertical CCD Clock, Phase 3, Bottom
59	V4B	Vertical CCD Clock, Phase 4, Bottom
60	V1B	Vertical CCD Clock, Phase 1, Bottom
61	V2B	Vertical CCD Clock, Phase 2, Bottom
62	VDDa	Output Amplifier Supply, Quadrant a
63	VOUta	Video Output, Quadrant a
64	GND	Ground

1. Liked named pins are internally connected and should have a common drive signal.

IMAGING PERFORMANCE

Typical Operational Conditions

Unless otherwise noted, the Imaging Performance Specifications are measured using the following conditions.

Table 6. TYPICAL OPERATIONAL CONDITIONS

Description	Condition	Notes
Light Source	Continuous Red, Green and Blue LED Illumination.	1
Operation	Nominal Operating Voltages and Timing.	

1. For monochrome sensor, only green LED used.

Specifications

Table 7. PERFORMANCE SPECIFICATIONS

Description	Symbol	Min.	Nom.	Max.	Unit	Sampling Plan	Temperature Tested at (°C)
ALL CONFIGURATIONS							
Dark Field Global Non-Uniformity	DSNU	–	–	2.0	mVpp	Die	27, 40
Bright Field Global Non-Uniformity (Note 1)		–	2.0	5.0	% rms	Die	27, 40
Bright Field Global Peak to Peak Non-Uniformity (Note 1)	PRNU	–	5.0	15.0	% pp	Die	27, 40
Bright Field Center Non-Uniformity (Note 1)		–	1.0	2.0	% rms	Die	27, 40
Maximum Photoresponse Non-Linearity (Note 2)	NL	–	2	–	%	Design	
Maximum Gain Difference between Outputs (Note 2)	ΔG	–	10	–	%	Design	
Maximum Signal Error due to Non-Linearity Differences (Note 2)	ΔNL	–	1	–	%	Design	
Horizontal CCD Charge Capacity	H_{Ne}	–	55	–	ke^-	Design	
Vertical CCD Charge Capacity	V_{Ne}	–	45	–	ke^-	Design	
Photodiode Charge Capacity (Note 3)	P_{Ne}	–	20	–	ke^-	Die	27, 40
Horizontal CCD Charge Transfer Efficiency	HCTTE	0.999995	0.999999	–		Die	
Vertical CCD Charge Transfer Efficiency	VCTE	0.999995	0.999999	–		Die	
Photodiode Dark Current	I_{PD}	–	7	70	e/p/s	Die	40
Vertical CCD Dark Current	I_{VD}	–	100	300	e/p/s	Die	40
Image Lag	Lag	–	–	10	e^-	Design	
Anti-Blooming Factor	X_{AB}	300	–	–		Design	
Vertical Smear	Smr	–	–100	–	dB	Design	
Read Noise (Note 4)	n_{e-T}	–	12	–	e^- rms	Design	
Dynamic Range (Notes 4, 5)	DR	–	64	–	dB	Design	
Output Amplifier DC Offset	V_{ODC}	–	9.4	–	V	Die	27, 40
Output Amplifier Bandwidth (Note 6)	f_{-3db}	–	250	–	MHz	Die	
Output Amplifier Impedance	R_{OUT}	–	127	–	Ω	Die	27, 40
Output Amplifier Sensitivity	$\Delta V/\Delta N$	–	34	–	$\mu V/e^-$	Design	

KAI-02150

Table 7. PERFORMANCE SPECIFICATIONS (continued)

Description	Symbol	Min.	Nom.	Max.	Unit	Sampling Plan	Temperature Tested at (°C)
-------------	--------	------	------	------	------	---------------	----------------------------

KAI-02150-ABA, KAI-02150-QBA AND KAI-02150-PBA CONFIGURATIONS (Note 7)

Peak Quantum Efficiency	QE _{MAX}	–	44	–	%	Design	
Peak Quantum Efficiency Wavelength	λ _{QE}	–	480	–	nm	Design	

KAI-02150-FBA AND KAI-02150-QBA GEN2 COLOR CONFIGURATIONS WITH MAR GLASS

Peak Quantum Efficiency Blue Green Red	QE _{MAX}	– – –	38 37 31	– – –	%	Design	
Peak Quantum Efficiency Wavelength Blue Green Red	λ _{QE}	– – –	460 530 605	– – –	nm	Design	

KAI-02150-FBA GEN2 COLOR CONFIGURATIONS WITH CLEAR GLASS

Peak Quantum Efficiency Blue Green Red	QE _{MAX}	– – –	35 34 29	– – –	%	Design	
Peak Quantum Efficiency Wavelength Blue Green Red	λ _{QE}	– – –	460 530 605	– – –	nm	Design	

KAI-02150-CBA AND KAI-02150-PBA GEN1 COLOR CONFIGURATIONS WITH MAR GLASS (Note 7)

Peak Quantum Efficiency Blue Green Red	QE _{MAX}	– – –	39 37 29	– – –	%	Design	
Peak Quantum Efficiency Wavelength Blue Green Red	λ _{QE}	– – –	470 540 620	– – –	nm	Design	

KAI-02150-CBA GEN1 COLOR CONFIGURATION WITH CLEAR GLASS (Note 7)

Peak Quantum Efficiency Blue Green Red	QE _{MAX}	– – –	36 34 27	– – –	%	Design	
Peak Quantum Efficiency Wavelength Blue Green Red	λ _{QE}	– – –	470 540 620	– – –	nm	Design	

1. Per color.
2. Value is over the range of 10% to 90% of photodiode saturation.
3. The operating value of the substrate voltage, V_{AB}, will be marked on the shipping container for each device. The value of V_{AB} is set such that the photodiode charge capacity is 680 mV.
4. At 40 MHz.
5. Uses 20LOG (P_{Ne} / n_{e-T}).
6. Assumes 5 pF load.
7. This color filter set configuration (Gen1) is not recommended for new designs.

TYPICAL PERFORMANCE CURVES

Quantum Efficiency

Monochrome with Microlens

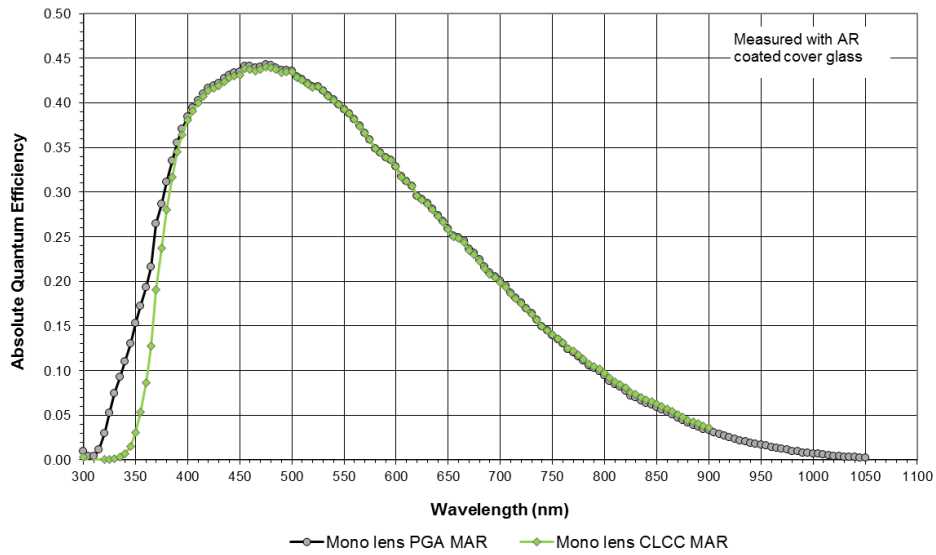

NOTE: The PGA and CLCC versions have different quantum efficiencies due to differences in the cover glass transmission. See Figure 35: Cover Glass Transmission for more details.

Figure 7. Monochrome with Microlens Quantum Efficiency

Monochrome without Microlens

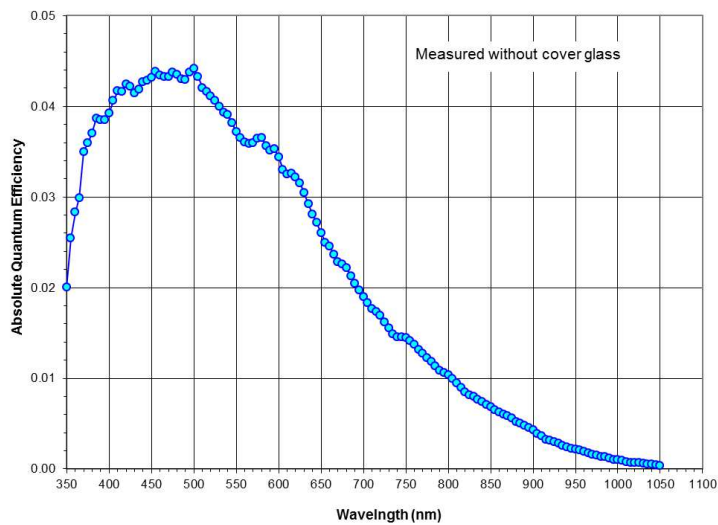

Figure 8. Monochrome without Microlens Quantum Efficiency

Color (Bayer RGB) with Microlens and MAR Cover Glass (Gen2 and Gen1 CFA)

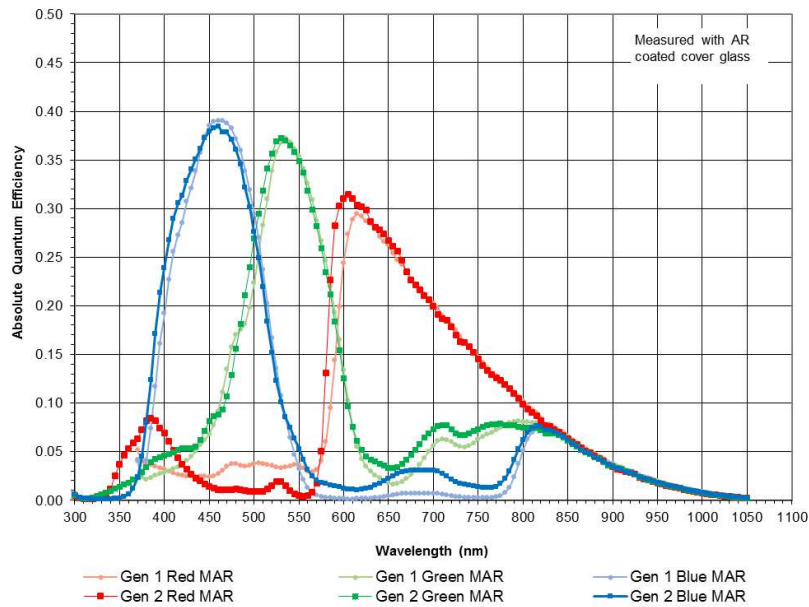

Figure 9. MAR Glass Color (Bayer) with Microlens Quantum Efficiency

Color (Bayer RGB) with Microlens and Clear Cover Glass (Gen2 and Gen1 CFA)

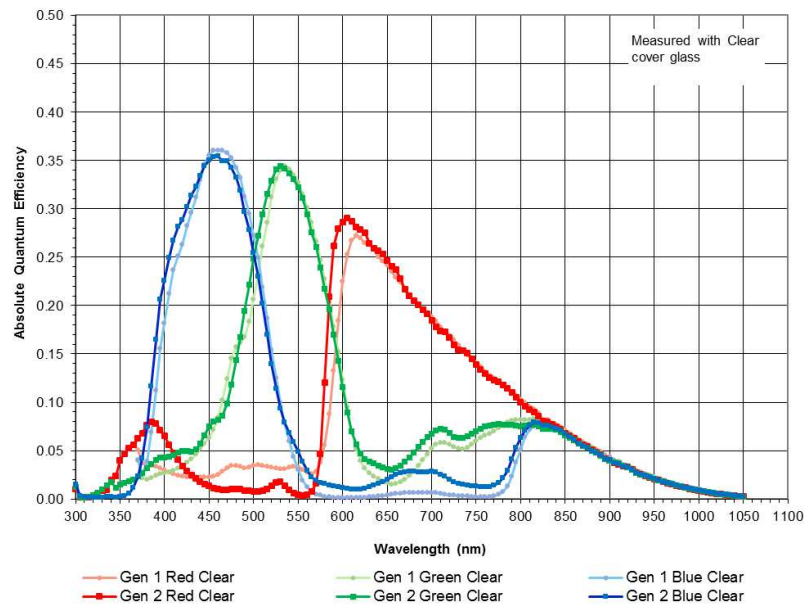

Figure 10. Clear Glass Color (Bayer) with Microlens Quantum Efficiency

Color (TRUESENSE Sparse CFA) with Microlens (Gen2 and Gen1 CFA)

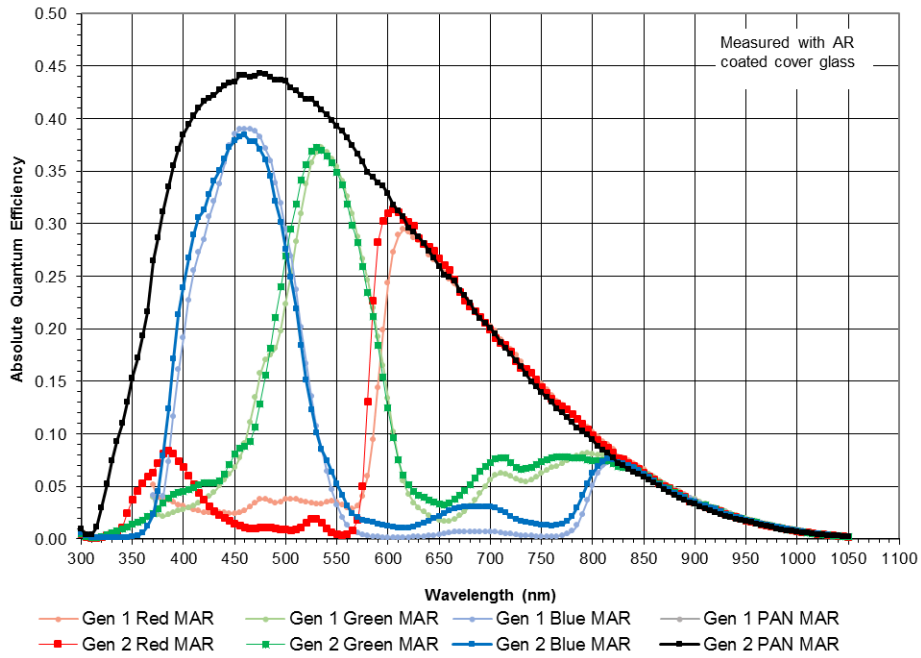

Figure 11. Color (TRUESENSE Sparse CFA) with Microlens Quantum Efficiency

Angular Quantum Efficiency

For the curves marked “Horizontal”, the incident light angle is varied in a plane parallel to the HCCD. For the curves marked “Vertical”, the incident light angle is varied in a plane parallel to the VCCD.

Monochrome with Microlens

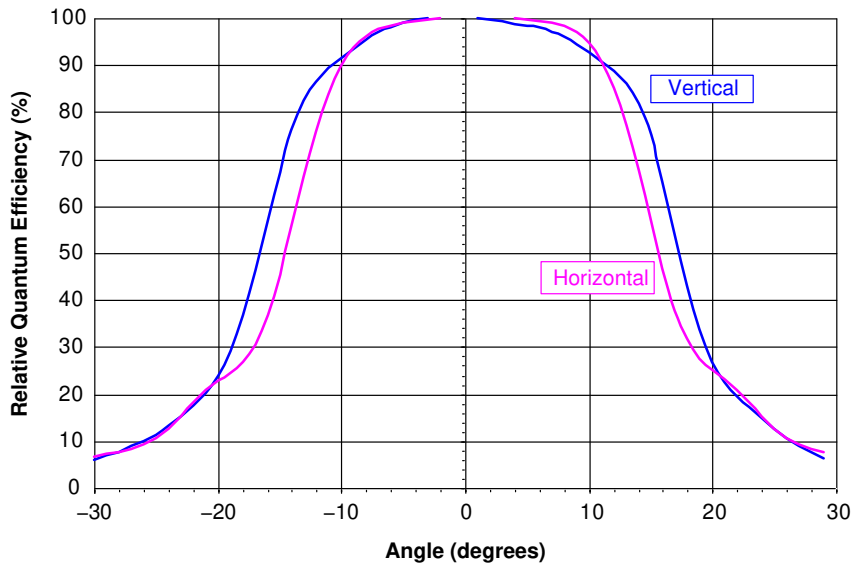

Figure 12. Monochrome with Microlens Angular Quantum Efficiency

Dark Current vs. Temperature

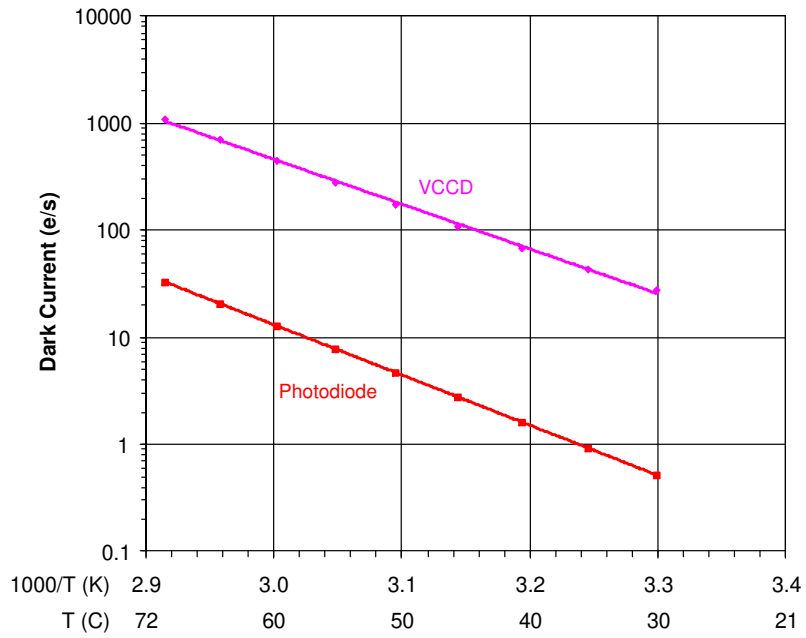

Figure 13. Dark Current vs. Temperature

Power-Estimated

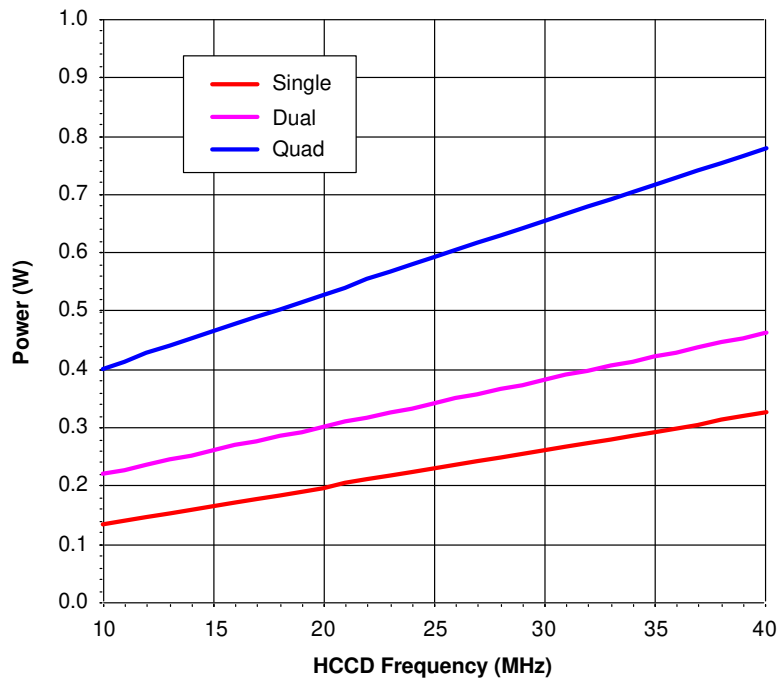

Figure 14. Power

Frame Rates

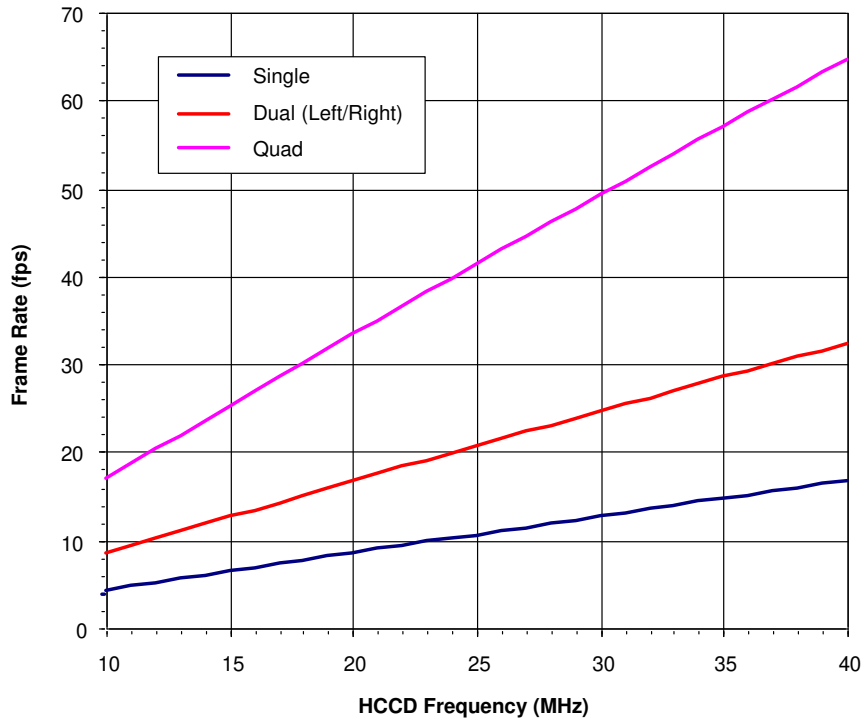

Figure 15. Frame Rates

KAI-02150

DEFECT DEFINITIONS

Table 8. OPERATION CONDITIONS FOR DEFECT TESTING AT 40°C

Description	Condition	Notes
Operational Mode	Two Outputs, Using VOUTa and VOUTc, Continuous Readout	
HCCD Clock Frequency	10 MHz	
Pixels per Line	2,160	1
Lines per Frame	672	2
Line Time	218.9 μ s	
Frame Time	147.1 ms	
Photodiode Integration Time	Mode A: PD_Tint = Frame Time = 147.1 ms, No Electronic Shutter Used Mode B: PD_Tint = 33 ms, Electronic Shutter Used	
VCCD Integration Time	125.2 ms	3
Temperature	40°C	
Light Source	Continuous Red, Green and Blue LED Illumination	4
Operation	Nominal Operating Voltages and Timing	

1. Horizontal overclocking used.
2. Vertical overclocking used.
3. VCCD Integration Time = 572 lines \times Line Time, which is the total time a pixel will spend in the VCCD registers.
4. For monochrome sensor, only the green LED is used.

Table 9. DEFECT DEFINITIONS FOR TESTING AT 40°C

Description	Definition	Standard Grade	Grade 2	Notes
Major Dark Field Defective Bright Pixel	PD_Tint = Mode A \rightarrow Defect \geq 51 mV or PD_Tint = Mode B \rightarrow Defect \geq 12 mV	20	20	1
Major Bright Field Defective Dark Pixel	Defect \geq 12%	20	20	1
Minor Dark Field Defective Bright Pixel	PD_Tint = Mode A \rightarrow Defect \geq 26 mV or PD_Tint = Mode B \rightarrow Defect \geq 6 mV	200	200	
Cluster Defect (Standard Grade)	A group of 2 to 10 contiguous major defective pixels, but no more than 2 adjacent defect horizontally.	8	N/A	2
Cluster Defect (Grade 2)	A group of 2 to 10 contiguous major defective pixels.	N/A	10	2
Column Defect	A group of more than 10 contiguous major defective pixels along a single column.	0	0	2

1. For the color device (KAI-02150-FBA, KAI-02150-CBA, KAI-02150-QBA, or KAI-02150-PBA), a bright field defective pixel deviates by 12% with respect to pixels of the same color.
2. Column and cluster defects are separated by no less than two (2) good pixels in any direction (excluding single pixel defects).

KAI-02150

Table 10. OPERATION CONDITIONS FOR DEFECT TESTING AT 27°C

Description	Condition	Notes
Operational Mode	Two Outputs, Using VOUTa and VOUTc, Continuous Readout	
HCCD Clock Frequency	20 MHz	
Pixels per Line	2,160	1
Lines per Frame	672	2
Line Time	109.8 μs	
Frame Time	73.8 ms	
Photodiode Integration Time (PD_Tint)	Mode A: PD_Tint = Frame Time = 73.8 ms, No Electronic Shutter Used Mode B: PD_Tint = 33 ms, Electronic Shutter Used	
VCCD Integration Time	62.8 ms	3
Temperature	27°C	
Light Source	Continuous Red, Green and Blue LED Illumination	4
Operation	Nominal Operating Voltages and Timing	

1. Horizontal overclocking used.
2. Vertical overclocking used.
3. VCCD Integration Time = 572 lines × Line Time, which is the total time a pixel will spend in the VCCD registers.
4. For monochrome sensor, only the green LED is used.

Table 11. DEFECT DEFINITIONS FOR TESTING AT 40°C

Description	Definition	Standard Grade	Grade 2	Notes
Major Dark Field Defective Bright Pixel	PD_Tint = Mode A → Defect ≥ 8 mV or PD_Tint = Mode B → Defect ≥ 4 mV	20	20	1
Major Bright Field Defective Dark Pixel	Defect ≥ 12%	20	20	1
Cluster Defect (Standard Grade)	A group of 2 to 10 contiguous major defective pixels, but no more than 2 adjacent defect horizontally.	8	N/A	2
Cluster Defect (Grade 2)	A group of 2 to 10 contiguous major defective pixels.	N/A	10	2
Column Defect	A group of more than 10 contiguous major defective pixels along a single column.	0	0	2

1. For the color device (KAI-02150-FBA, KAI-02150-CBA, KAI-02150-QBA, or KAI-02150-PBA), a bright field defective pixel deviates by 12% with respect to pixels of the same color.
2. Column and cluster defects are separated by no less than two (2) good pixels in any direction (excluding single pixel defects).

Defect Map

The defect map supplied with each sensor is based upon testing at an ambient (27°C) temperature. Minor point defects are not included in the defect map. All defective

pixels are reference to pixel 1, 1 in the defect maps. See Figure 16: Regions of Interest for the location of pixel 1, 1.

TEST DEFINITIONS

Test Regions of Interest

Image Area ROI: Pixel (1, 1) to Pixel (1960, 1120)
 Active Area ROI: Pixel (21, 21) to Pixel (1940, 1100)
 Center ROI: Pixel (931, 511) to Pixel (1030, 610)

Only the Active Area ROI pixels are used for performance and defect tests.

Overclocking

The test system timing is configured such that the sensor is overclocked in both the vertical and horizontal directions. See Figure 16 for a pictorial representation of the regions of interest.

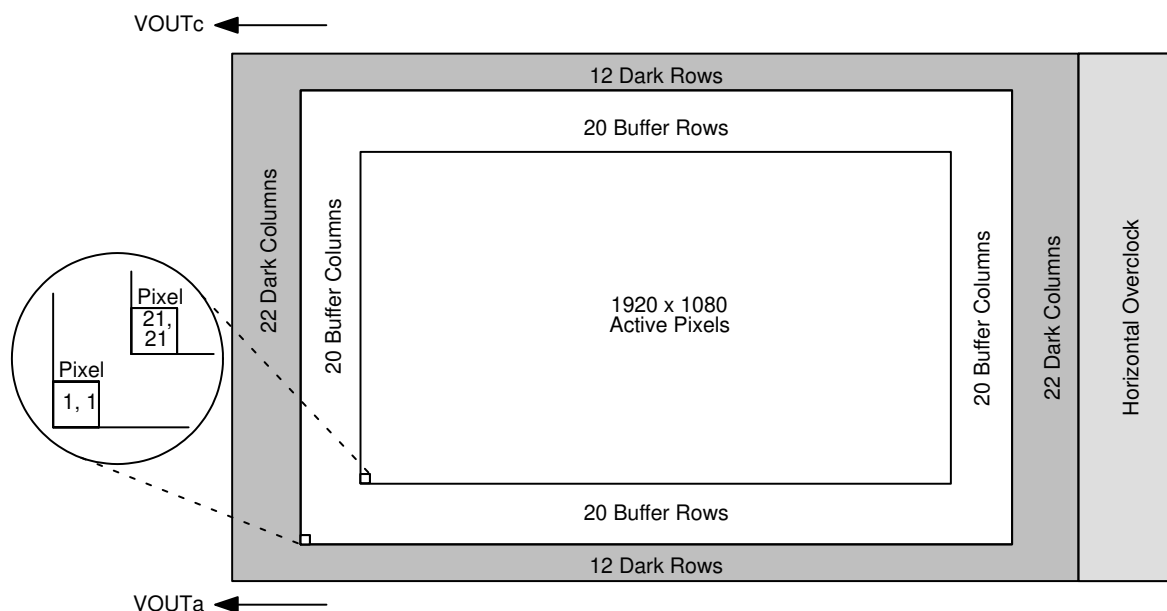

Figure 16. Regions of Interest

Tests

Dark Field Global Non-Uniformity

This test is performed under dark field conditions. The sensor is partitioned into 144 sub regions of interest, each of which is 120 by 120 pixels in size. See Figure 17: Test Sub Regions of Interest. The average signal level of each of the 144 sub regions of interest is calculated. The signal level of each of the sub regions of interest is calculated using the following formula:

$$\text{Signal of ROI}[i] = (\text{ROI Average in Counts} - \text{Horizontal Overclock Average in Counts}) \cdot \text{mV per Count}$$

Units : mVpp (millivolts Peak to Peak)

Where i = 1 to 144. During this calculation on the 144 sub regions of interest, the maximum and minimum signal levels are found. The dark field global uniformity is then calculated as the maximum signal found minus the minimum signal level found.

Global Non-Uniformity

This test is performed with the imager illuminated to a level such that the output is at 70% of saturation (approximately 476 mV). Prior to this test being performed the substrate

voltage has been set such that the charge capacity of the sensor is 680 mV. Global non-uniformity is defined as

$$\text{Global Non-Uniformity} = 100 \cdot \left(\frac{\text{Active Area Standard Deviation}}{\text{Active Area Signal}} \right)$$

Units : % rms

Active Area Signal = Active Area Average – Dark Column Average

Global Peak to Peak Non-Uniformity

This test is performed with the imager illuminated to a level such that the output is at 70% of saturation (approximately 476 mV). Prior to this test being performed the substrate voltage has been set such that the charge capacity of the sensor is 680 mV. The sensor is partitioned into 144 sub regions of interest, each of which is 120 by 120 pixels in size. See Figure 17: Test Sub Regions of Interest. The average signal level of each of the 144 sub regions of interest (ROI) is calculated. The signal level of each of the sub regions of interest is calculated using the following formula:

$$\text{Signal of ROI}[i] = (\text{ROI Average in Counts} - \text{Horizontal Overclock Average in Counts}) \cdot \text{mV per Count}$$

Where $i = 1$ to 144. During this calculation on the 144 sub regions of interest, the maximum and minimum signal levels are found. The global peak to peak uniformity is then calculated as:

$$\text{Global Uniformity} = 100 \cdot \left(\frac{\text{Max. Signal} - \text{Min. Signal}}{\text{Active Area Signal}} \right)$$

Units : % pp

Center Non-Uniformity

This test is performed with the imager illuminated to a level such that the output is at 70% of saturation (approximately 476 mV). Prior to this test being performed the substrate voltage has been set such that the charge capacity of the sensor is 680 mV. Defects are excluded for the calculation of this test. This test is performed on the center 100 by 100 pixels of the sensor. Center uniformity is defined as:

$$\text{Center ROI Uniformity} = 100 \cdot \left(\frac{\text{Center ROI Standard Deviation}}{\text{Center ROI Signal}} \right)$$

Units : % rms

Center ROI Signal = Center ROI Average – Dark Column Average

Dark Field Defect Test

This test is performed under dark field conditions. The sensor is partitioned into 144 sub regions of interest, each of which is 120 by 120 pixels in size. In each region of interest, the median value of all pixels is found. For each region of interest, a pixel is marked defective if it is greater than or equal to the median value of that region of interest plus the defect threshold specified in the “Defect Definitions” section.

Bright Field Defect Test

This test is performed with the imager illuminated to a level such that the output is at approximately 476 mV.

Prior to this test being performed the substrate voltage has been set such that the charge capacity of the sensor is 680 mV. The average signal level of all active pixels is found. The bright and dark thresholds are set as:

$$\text{Dark Defect Threshold} = \text{Active Area Signal} \cdot \text{Threshold}$$

$$\text{Bright Defect Threshold} = \text{Active Area Signal} \cdot \text{Threshold}$$

The sensor is then partitioned into 144 sub regions of interest, each of which is 120 by 120 pixels in size. In each region of interest, the average value of all pixels is found. For each region of interest, a pixel is marked defective if it is greater than or equal to the median value of that region of interest plus the bright threshold specified or if it is less than or equal to the median value of that region of interest minus the dark threshold specified.

Example for major bright field defective pixels:

- Average value of all active pixels is found to be 476 mV.
- Dark defect threshold: $476 \text{ mV} \cdot 12 \% = 57 \text{ mV}$.
- Bright defect threshold: $476 \text{ mV} \cdot 12 \% = 57 \text{ mV}$.
- Region of interest #1 selected. This region of interest is pixels 21, 21 to pixels 140, 140.
 - ♦ Median of this region of interest is found to be 470 mV.
 - ♦ Any pixel in this region of interest that is $\geq (470 + 57 \text{ mV})$ 527 mV in intensity will be marked defective.
 - ♦ Any pixel in this region of interest that is $\leq (470 - 57 \text{ mV})$ 413 mV in intensity will be marked defective.
- All remaining 144 sub regions of interest are analyzed for defective pixels in the same manner.

Test Sub Regions of Interest

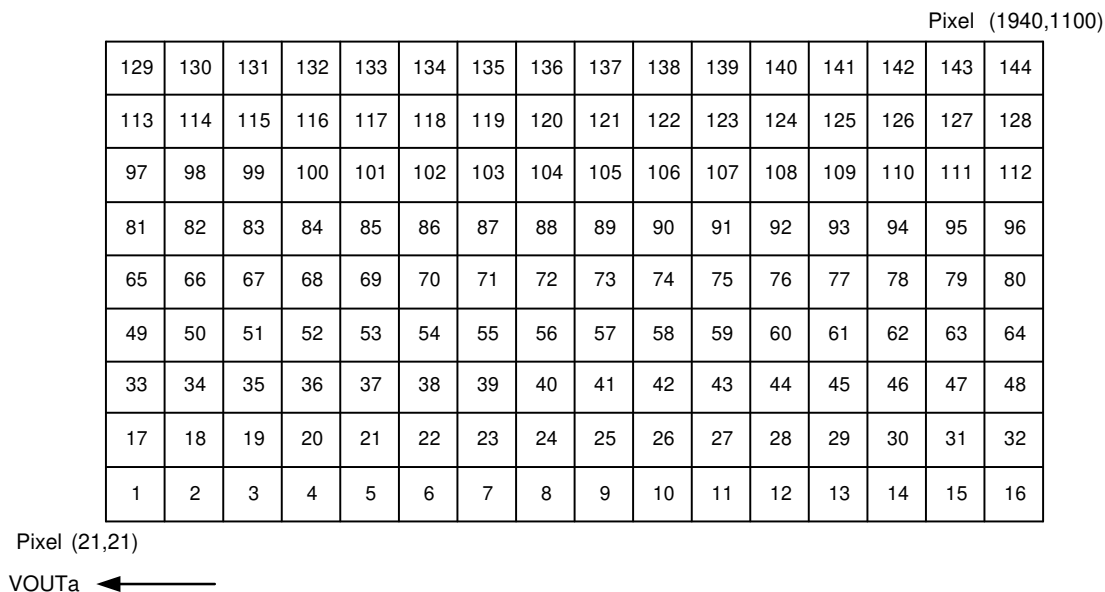

Figure 17. Test Sub Regions of Interest

OPERATION

Absolute Maximum Ratings

Absolute maximum rating is defined as a level or condition that should not be exceeded at any time per the

description. If the level or the condition is exceeded, the device will be degraded and may be damaged. Operation at these values will reduce MTTF.

Table 12. ABSOLUTE MAXIMUM RATINGS

Description	Symbol	Minimum	Maximum	Unit	Notes
Operating Temperature	T _{OP}	-50	70	°C	1
Humidity	RH	5	90	%	2
Output Bias Current	I _{OUT}	-	60	mA	3
Off-Chip Load	C _L	-	10	pF	

Stresses exceeding those listed in the Maximum Ratings table may damage the device. If any of these limits are exceeded, device functionality should not be assumed, damage may occur and reliability may be affected.

- Noise performance will degrade at higher temperatures.
- T = 25°C. Excessive humidity will degrade MTTF.
- Total for all outputs. Maximum current is -15 mA for each output. Avoid shorting output pins to ground or any low impedance source during operation. Amplifier bandwidth increases at higher current and lower load capacitance at the expense of reduced gain (sensitivity).

Table 13. ABSOLUTE MAXIMUM VOLTAGE RATINGS BETWEEN PINS AND GROUND

Description	Minimum	Maximum	Unit	Notes
VDD _α , VOUT _α	-0.4	17.5	V	1
RD _α	-0.4	15.5	V	1
V1B, V1T	ESD - 0.4	ESD + 24.0	V	
V2B, V2T, V3B, V3T, V4B, V4T	ESD - 0.4	ESD + 14.0	V	
H1S _α , H1B _α , H2S _α , H2B _α , H2SL _α , R _α , OG _α	ESD - 0.4	ESD + 14.0	V	1
ESD	-10.0	0.0	V	
SUB	-0.4	40.0	V	2

- α denotes a, b, c or d.
- Refer to Application Note *Using Interline CCD Image Sensors in High Intensity Visible Lighting Conditions*

Power-Up and Power-Down Sequence

Adherence to the power-up and power-down sequence is critical. Failure to follow the proper power-up and power-down sequences may cause damage to the sensor.

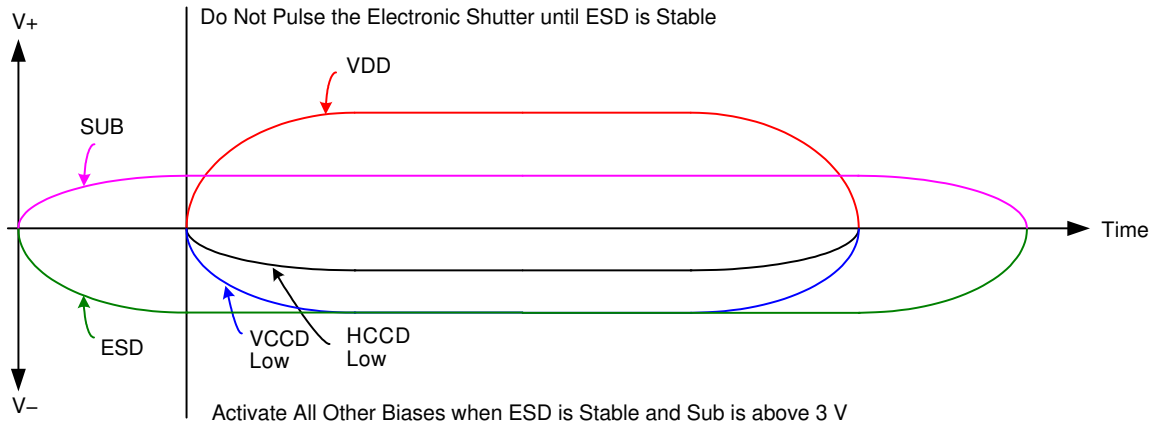

Notes:

1. Activate all other biases when ESD is stable and SUB is above 3 V.
2. Do not pulse the electronic shutter until ESD is stable.
3. VDD cannot be +15 V when SUB is 0 V.
4. The image sensor can be protected from an accidental improper ESD voltage by current limiting the SUB current to less than 10 mA. SUB and VDD must always be greater than GND. ESD must always be less than GND. Placing diodes between SUB, VDD, ESD and ground will protect the sensor from accidental overshoots of SUB, VDD and ESD during power on and power off. See the figure below.

Figure 18. Power-Up and Power-Down Sequence

The VCCD clock waveform must not have a negative overshoot more than 0.4 V below the ESD voltage.

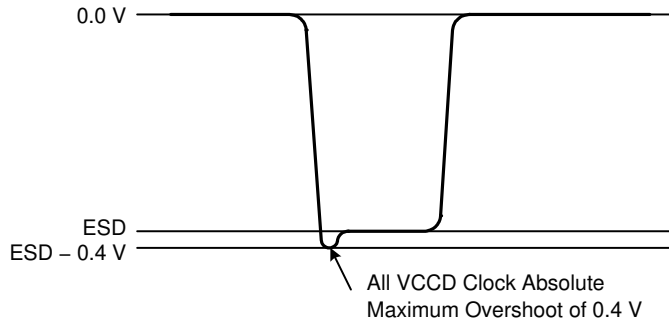

Figure 19. VCCD Clock Waveform

Example of external diode protection for SUB, VDD and ESD. α denotes a, b, c or d.

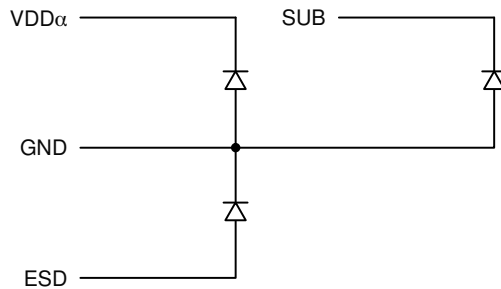

Figure 20. Example of External Diode Protection

DC Bias Operating Conditions

Table 14. DC BIAS OPERATING CONDITIONS

Description	Pins	Symbol	Min.	Nom.	Max.	Unit	Max. DC Current	Notes
Reset Drain	RD α	RD	11.8	12.0	12.2	V	10 μ A	1
Output Gate	OG α	OG	-2.2	-2.0	-1.8	V	10 μ A	1
Output Amplifier Supply	VDD α	V _{DD}	14.5	15.0	15.5	V	11.0 mA	1, 2
Ground	GND	GND	0.0	0.0	0.0	V	-1.0 mA	
Substrate	SUB	V _{SUB}	5.0	V _{AB}	V _{DD}	V	50 μ A	3, 8
ESD Protection Disable	ESD	ESD	-9.5	-9.0	V _{x_L}	V	50 μ A	6, 7, 9
Output Bias Current	VOU α	I _{OUT}	-3.0	-7.0	-10.0	mA	-	1, 4, 5

1. α denotes a, b, c or d.
2. The maximum DC current is for one output. $I_{DD} = I_{OUT} + I_{SS}$. See Figure 21.
3. The operating value of the substrate voltage, V_{AB} , will be marked on the shipping container for each device. The value of V_{AB} is set such that the photodiode charge capacity is the nominal P_{Ne} (see Specifications).
4. An output load sink must be applied to each VOUT pin to activate each output amplifier.
5. Nominal value required for 40 MHz operation per output. May be reduced for slower data rates and lower noise.
6. Adherence to the power-up and power-down sequence is critical. See Power Up and Power Down Sequence section.
7. ESD maximum value must be less than or equal to $V1_L + 0.4$ V and $V2_L + 0.4$ V.
8. Refer to Application Note *Using Interline CCD Image Sensors in High Intensity Visible Lighting Conditions*.
9. Where V_{x_L} is the level set for $V1_L$, $V2_L$, $V3_L$, or $V4_L$ in the application.

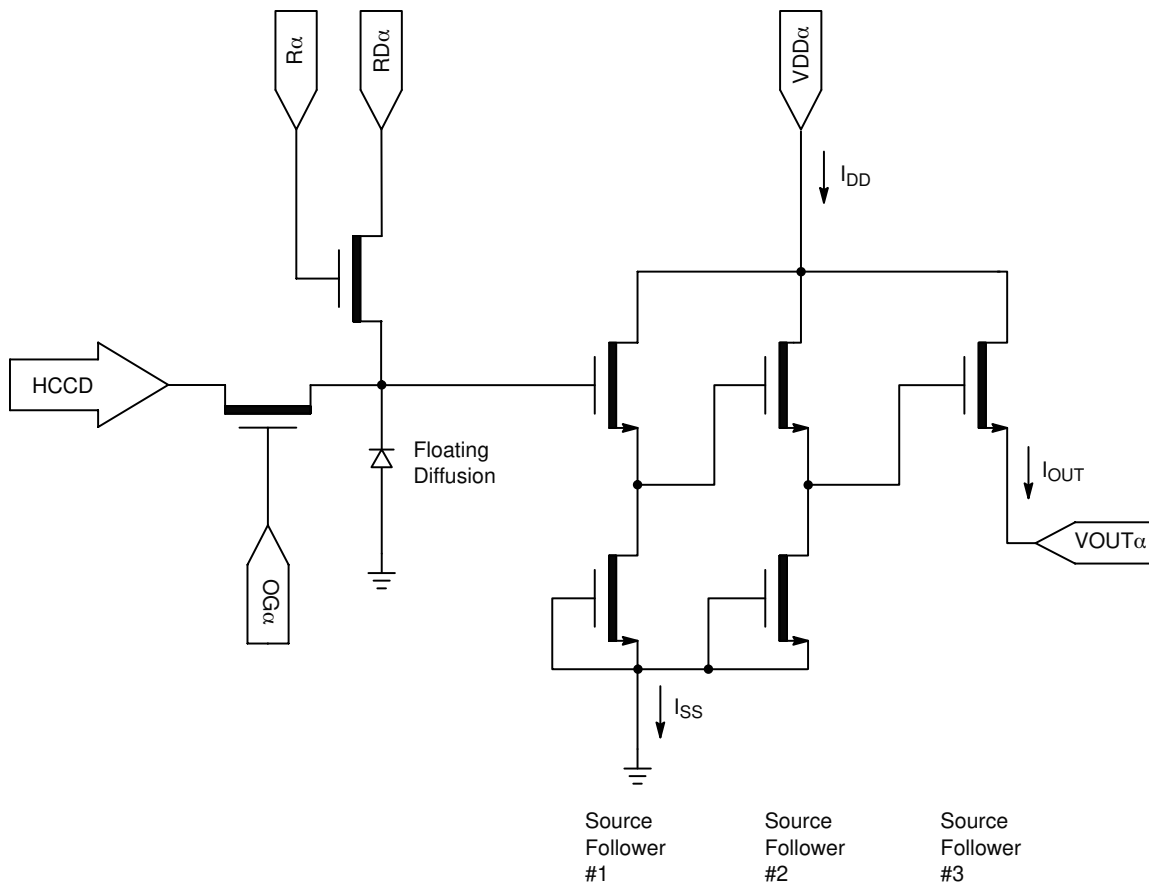

Figure 21. Output Amplifier

AC Operating Conditions

Table 15. CLOCK LEVELS

Description	Pins (Note 1)	Symbol	Level	Min.	Nom.	Max.	Unit	Capacitance (Note 2)
Vertical CCD Clock, Phase 1	V1B, V1T	V1_L	Low	-8.2	-8.0	-7.8	V	12 nF (Note 6)
		V1_M	Mid	-0.2	0.0	0.2		
		V1_H	High	11.5	12.0	12.5		
Vertical CCD Clock, Phase 2	V2B, V2T	V2_L	Low	-8.2	-8.0	-7.8	V	12 nF (Note 6)
		V2_H	High	-0.2	0.0	0.2		
Vertical CCD Clock, Phase 3	V3B, V3T	V3_L	Low	-8.2	-8.0	-7.8	V	12 nF (Note 6)
		V3_H	High	-0.2	0.0	0.2		
Vertical CCD Clock, Phase 4	V4B, V4T	V4_L	Low	-8.2	-8.0	-7.8	V	12 nF (Note 6)
		V4_H	High	-0.2	0.0	0.2		
Horizontal CCD Clock, Phase 1 Storage	H1S α	H1S_L	Low	-5.2 (Note 7)	-4.0	-3.8	V	170 pF (Note 6)
		H1S_A	Amplitude	3.8	4.0	5.2 (Note 7)		
Horizontal CCD Clock, Phase 1 Barrier	H1B α	H1B_L	Low	-5.2 (Note 7)	-4.0	-3.8	V	110 pF (Note 6)
		H1B_A	Amplitude	3.8	4.0	5.2 (Note 7)		
Horizontal CCD Clock, Phase 2 Storage	H2S α	H2S_L	Low	-5.2 (Note 7)	-4.0	-3.8	V	170 pF (Note 6)
		H2S_A	Amplitude	3.8	4.0	5.2 (Note 7)		
Horizontal CCD Clock, Phase 2 Barrier	H2B α	H2B_L	Low	-5.2 (Note 7)	-4.0	-3.8	V	110 pF (Note 6)
		H2B_A	Amplitude	3.8	4.0	5.2 (Note 7)		
Horizontal CCD Clock, Phase 2 Last Phase (Note 3)	H2SL α	H2SL_L	Low	-5.2	-5.0	-4.8	V	20 pF (Note 6)
		H2SL_A	Amplitude	4.8	5.0	5.2		
Reset Gate	R α	R_L (Note 4)	Low	-3.5	-2.0	-1.5	V	16 pF (Note 6)
		R_H	High	2.5	3.0	4.0		
Electronic Shutter (Note 5)	SUB	VES	High	29.0	30.0	40.0	V	800 pF (Note 6)

- α denotes a, b, c or d.
- Capacitance is total for all like named pins.
- Use separate clock driver for improved speed performance.
- Reset low should be set to -3 V for signal levels greater than 40,000 electrons.
- Refer to Application Note *Using Interline CCD Image Sensors in High Intensity Visible Lighting Conditions*.
- Capacitance values are estimated.
- If the minimum horizontal clock low level is used (-5.2 V), then the maximum horizontal clock amplitude should be used (5.2 V amplitude) to create a -5.2 V to 0.0 V clock. If a 5 V clock driver is used, the horizontal low level should be set to -5.0 V and the high level should be a set to 0.0 V.

The figure below shows the DC bias (VSUB) and AC clock (VES) applied to the SUB pin. Both the DC bias and AC clock are referenced to ground.

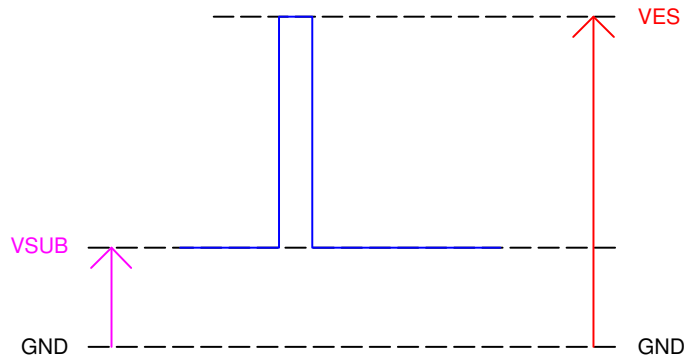

Figure 22. DC Bias and AC Clock Applied to the SUB Pin

Device Identification

The device identification pin (DevID) may be used to determine which Truesense Imaging 5.5 micron pixel interline CCD sensor is being used.

Table 16.

Description	Pins	Symbol	Min.	Nom.	Max.	Unit	Max. DC Current	Notes
Device Identification	DevID	DevID	49,000	55,000	61,000	Ω	50 μ A	1, 2, 3

1. Nominal value subject to verification and/or change during release of preliminary specifications.
2. If the Device Identification is not used, it may be left disconnected.
3. After Device Identification resistance has been read during camera initialization, it is recommended that the circuit be disabled to prevent localized heating of the sensor due to current flow through the R_DeviceID resistor.

Recommended Circuit

Note that V1 must be a different value than V2.

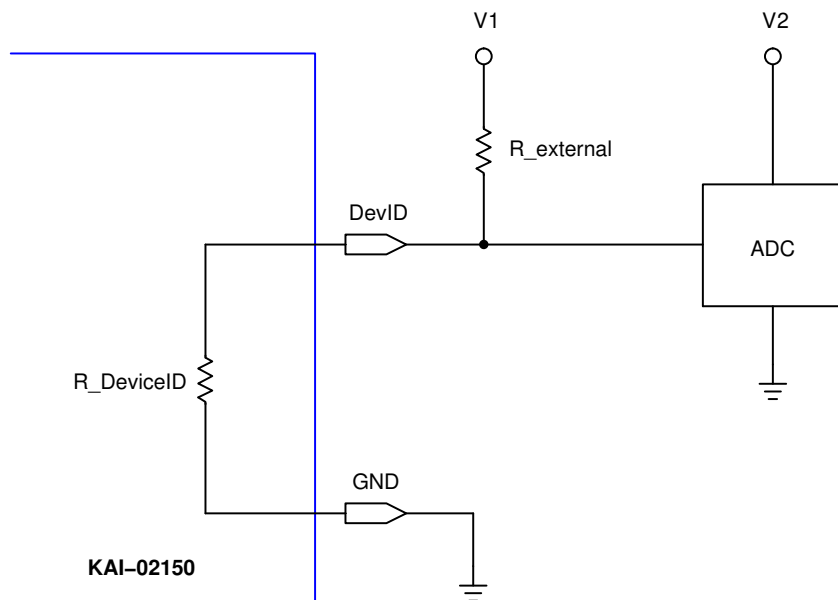

Figure 23. Device Identification Recommended Circuit