



Chipsmall Limited consists of a professional team with an average of over 10 year of expertise in the distribution of electronic components. Based in Hongkong, we have already established firm and mutual-benefit business relationships with customers from,Europe,America and south Asia,supplying obsolete and hard-to-find components to meet their specific needs.

With the principle of “Quality Parts,Customers Priority,Honest Operation,and Considerate Service”,our business mainly focus on the distribution of electronic components. Line cards we deal with include Microchip,ALPS,ROHM,Xilinx,Pulse,ON,Everlight and Freescale. Main products comprise IC,Modules,Potentiometer,IC Socket,Relay,Connector.Our parts cover such applications as commercial,industrial, and automotives areas.

We are looking forward to setting up business relationship with you and hope to provide you with the best service and solution. Let us make a better world for our industry!



Contact us

Tel: +86-755-8981 8866 Fax: +86-755-8427 6832

Email & Skype: info@chipsmall.com Web: www.chipsmall.com

Address: A1208, Overseas Decoration Building, #122 Zhenhua RD., Futian, Shenzhen, China



KAI-16070

4864 (H) x 3232 (V) Interline CCD Image Sensor

Description

The KAI-16070 Image Sensor is a 16-megapixel CCD in a 35 mm optical format. Based on the TRUESENSE 7.4 micron Interline Transfer CCD Platform, the sensor provides very high smear rejection and up to 82 dB linear dynamic range through the use of a unique dual-gain amplifier. Flexible readout architecture enables use of 1, 2, or 4 outputs for full resolution readout up to 8 frames per second, while a vertical overflow drain structure suppresses image blooming and enables electronic shuttering for precise exposure control.

The sensor is available with the TRUESENSE Sparse Color Filter Pattern, a technology which provides a 2x improvement in light sensitivity compared to a standard color Bayer part.

The sensor shares common pin-out and electrical configurations with a full family of ON Semiconductor Interline Transfer CCD image sensors, allowing a single camera design to be leveraged in support of multiple devices.

Table 1. GENERAL SPECIFICATIONS

Parameter	Typical Value
Architecture	Interline CCD; Progressive Scan
Total Number of Pixels	4932 (H) x 3300 (V)
Number of Effective Pixels	4888 (H) x 3256 (V)
Number of Active Pixels	4864 (H) x 3232 (V) (15.7 M)
Pixel Size	7.4 μm (H) x 7.4 μm (V)
Active Image Size	36.0 mm (H) x 23.9 mm (V) 43.2 mm (diag.) 35 mm Optical Format
Aspect Ratio	3:2
Number of Outputs	1, 2, or 4
Charge Capacity	44,000 electrons
Output Sensitivity	9.7 $\mu\text{V}/\text{e}^-$ (low), 33 $\mu\text{V}/\text{e}^-$ (high)
Quantum Efficiency	
Mono (-AAA)	10%
Mono (-AXA, -PXA, -QXA)	48%
R, G, B (-CXA)	32%, 41%, 39%
R, G, B (-FXA)	33%, 40%, 40%
Base ISO	
-AXA	350
-CXA, -PXA	130, 310 (respectively)
-FXA, -PXA	130, 310 (respectively)
Read Noise (f = 40 MHz)	12 electrons rms
Dark Current Photodiode / VCCD	1 / 145 electrons/s
Dark Current Doubling Temp. Photodiode / VCCD	7°C / 9°C
Dynamic Range	
High Gain Amp (40 MHz)	70 dB
Dual Amp, 2x2 Bin (40 MHz)	82 dB
Charge Transfer Efficiency	0.999999
Blooming Suppression	> 1000 X
Smear	-115 dB
Image Lag	< 10 electrons
Maximum Pixel Clock Speed	40 MHz
Maximum Frame Rates	
Quad / Dual / Single Output	8 / 4 / 2 fps
Package	72 pin PGA
Cover Glass	AR Coated, 2 Sides or Clear Glass

NOTE: All parameters are specified at T = 40°C unless otherwise noted.



ON Semiconductor®

www.onsemi.com



Figure 1. KAI-16070 CCD Image Sensor

Features

- Superior Smear Rejection
- Up to 82 dB Linear Dynamic Range
- Bayer Color Pattern, TRUESENSE Sparse Color Filter Pattern, and Monochrome Configurations
- Progressive Scan & Flexible Readout Architecture
- High Frame Rate
- High Sensitivity – Low Noise Architecture
- Package Pin Reserved for Device Identification

Applications

- Industrial Imaging and Inspection
- Traffic
- Aerial Photography

ORDERING INFORMATION

See detailed ordering and shipping information on page 2 of this data sheet.

KAI-16070

ORDERING INFORMATION

Table 2. ORDERING INFORMATION

Part Number	Description	Marking Code
KAI-16070-AAA-JP-B1	Monochrome, No Microlens, PGA Package, Taped Clear Cover Glass, no coatings, Standard Grade	KAI-16070-AAA Serial Number
KAI-16070-AAA-JP-AE	Monochrome, No Microlens, PGA Package, Taped Clear Cover Serial Number Glass, no coatings, Engineering Grade	
KAI-16070-AXA-JD-B1	Monochrome, Special Microlens, PGA Package, Sealed Clear Cover Glass with AR coating (both sides), Grade 1	KAI-16070-AXA Serial Number
KAI-16070-AXA-JD-B2	Monochrome, Special Microlens, PGA Package, Sealed Clear Cover Glass with AR coating (both sides), Grade 2	
KAI-16070-AXA-JD-AE	Monochrome, Special Microlens, PGA Package, Sealed Clear Cover Glass with AR coating (both sides), Engineering Grade	
KAI-16070-FXA-JD-B1	Gen2 Color (Bayer RGB), Special Microlens, PGA Package, Sealed Clear Cover Glass with AR coating (both sides), Grade 1	KAI-16070-FXA Serial Number
KAI-16070-FXA-JD-B2	Gen2 Color (Bayer RGB), Special Microlens, PGA Package, Sealed Clear Cover Glass with AR coating (both sides), Grade 2	
KAI-16070-FXA-JD-AE	Gen2 Color (Bayer RGB), Special Microlens, PGA Package, Sealed Clear Cover Glass with AR coating (both sides), Engineering Grade	
KAI-16070-QXA-JD-B1	Gen2 Color (TRUESENSE Sparse CFA), Special Microlens, PGA Package, Sealed Clear Cover Glass with AR coating (both sides), Grade 1	KAI-16070-QXA Serial Number
KAI-16070-QXA-JD-B2	Gen2 Color (TRUESENSE Sparse CFA), Special Microlens, PGA Package, Sealed Clear Cover Glass with AR coating (both sides), Grade 2	
KAI-16070-QXA-JD-AE	Gen2 Color (TRUESENSE Sparse CFA), Special Microlens, PGA Package, Sealed Clear Cover Glass with AR coating (both sides), Engineering Grade	
KAI-16070-CXA-JD-B1*	Gen1 Color (Bayer RGB), Special Microlens, PGA Package, Sealed Clear Cover Glass with AR coating (both sides), Grade 1	KAI-16070-CXA Serial Number
KAI-16070-CXA-JD-B2*	Gen1 Color (Bayer RGB), Special Microlens, PGA Package, Sealed Clear Cover Glass with AR coating (both sides), Grade 2	
KAI-16070-CXA-JD-AE*	Gen1 Color (Bayer RGB), Special Microlens, PGA Package, Sealed Clear Cover Glass with AR coating (both sides), Engineering Grade	
KAI-16070-PXA-JD-B1*	Gen1 Color (TRUESENSE Sparse CFA), Special Microlens, PGA Package, Sealed Clear Cover Glass with AR coating (both sides), Grade 1	KAI-16070-PXA Serial Number
KAI-16070-PXA-JD-B2*	Gen1 Color (TRUESENSE Sparse CFA), Special Microlens, PGA Package, Sealed Clear Cover Glass with AR coating (both sides), Grade 2	
KAI-16070-PXA-JD-AE*	Gen1 Color (TRUESENSE Sparse CFA), Special Microlens, PGA Package, Sealed Clear Cover Glass with AR coating (both sides), Engineering Grade	

*Not recommended for new designs.

See the ON Semiconductor *Device Nomenclature* document (TND310/D) for a full description of the naming convention used for image sensors. For reference documentation, including information on evaluation kits, please visit our web site at www.onsemi.com.

DEVICE DESCRIPTION

Architecture

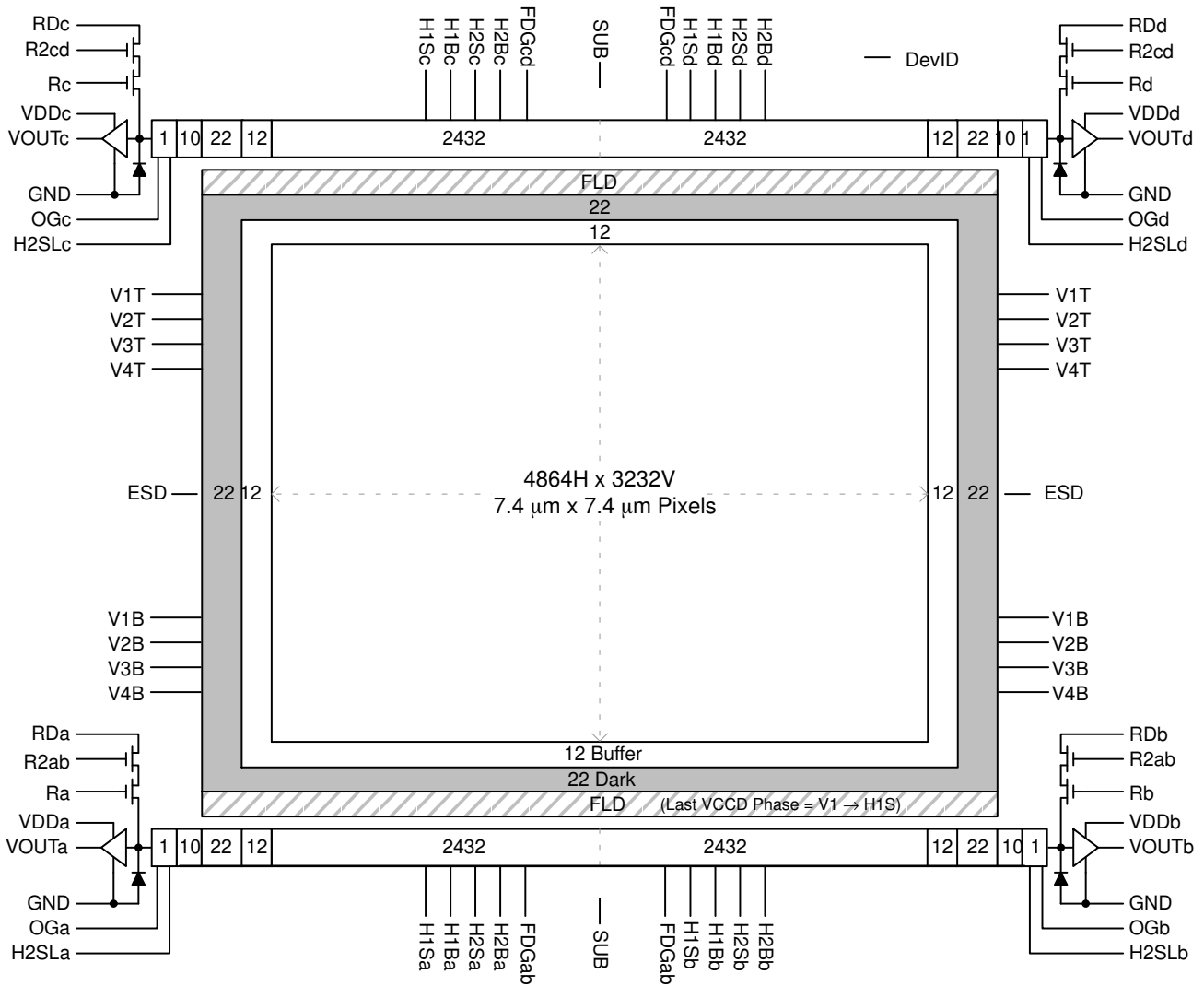

Figure 2. Block Diagram

Dark Reference Pixels

There are 22 dark reference rows at the top and 22 dark rows at the bottom of the image sensor. The dark rows are not entirely dark and so should not be used for a dark reference level. Use the 22 dark columns on the left or right side of the image sensor as a dark reference.

Under normal circumstances use only the center 20 columns of the 22 column dark reference due to potential light leakage.

Dummy Pixels

Within each horizontal shift register there are 11 leading additional shift phases. These pixels are designated as dummy pixels and should not be used to determine a dark reference level.

In addition, there is one dummy row of pixels at the top and bottom of the image.

Active Buffer Pixels

12 unshielded pixels adjacent to any leading or trailing dark reference regions are classified as active buffer pixels. These pixels are light sensitive but are not tested for defects and non-uniformities.

Image Acquisition

An electronic representation of an image is formed when incident photons falling on the sensor plane create electron-hole pairs within the individual silicon photodiodes. These photoelectrons are collected locally by the formation of potential wells at each photosite. Below photodiode saturation, the number of photoelectrons collected at each pixel is linearly dependent upon light level and exposure time and non-linearly dependent on wavelength. When the photodiodes charge capacity is reached, excess electrons are discharged into the substrate to prevent blooming.

KAI-16070

ESD Protection

Adherence to the power-up and power-down sequence is critical. Failure to follow the proper power-up and

power-down sequences may cause damage to the sensor. See Power-Up and Power-Down Sequence section.

Bayer Color Filter Pattern

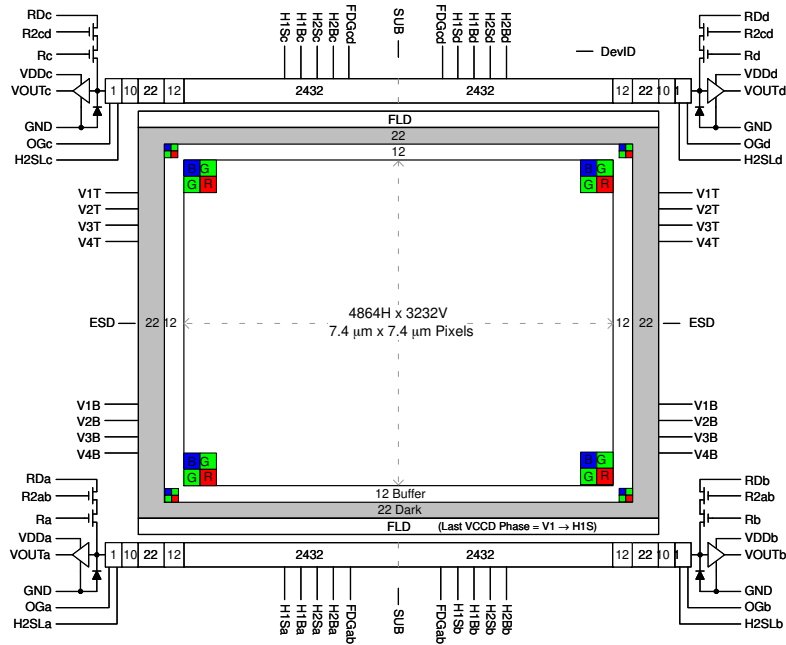

Figure 3. Bayer Color Filter Pattern

TRUESENSE Sparse Color Filter Pattern

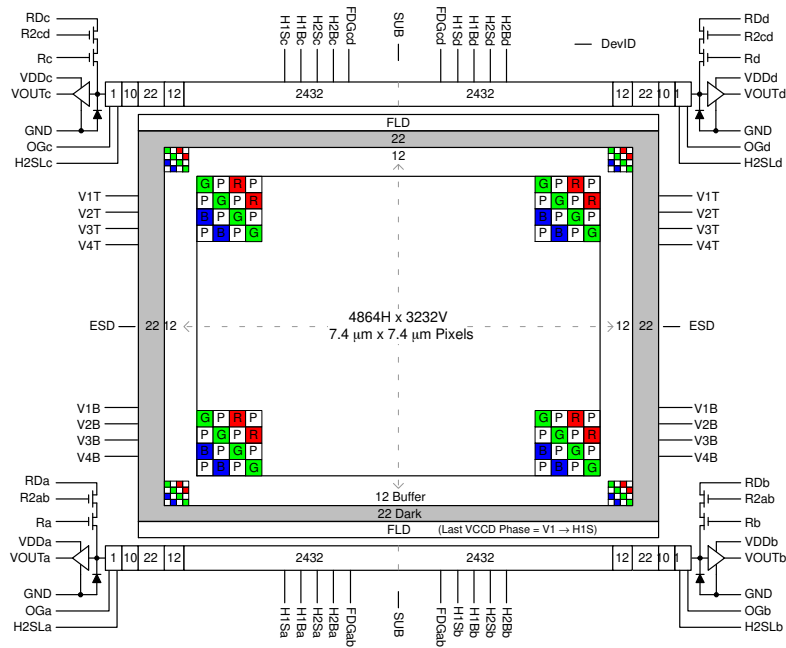

Figure 4. TRUESENSE Sparse Color Filter Pattern

PHYSICAL DESCRIPTION

Pin Description and Device Orientation

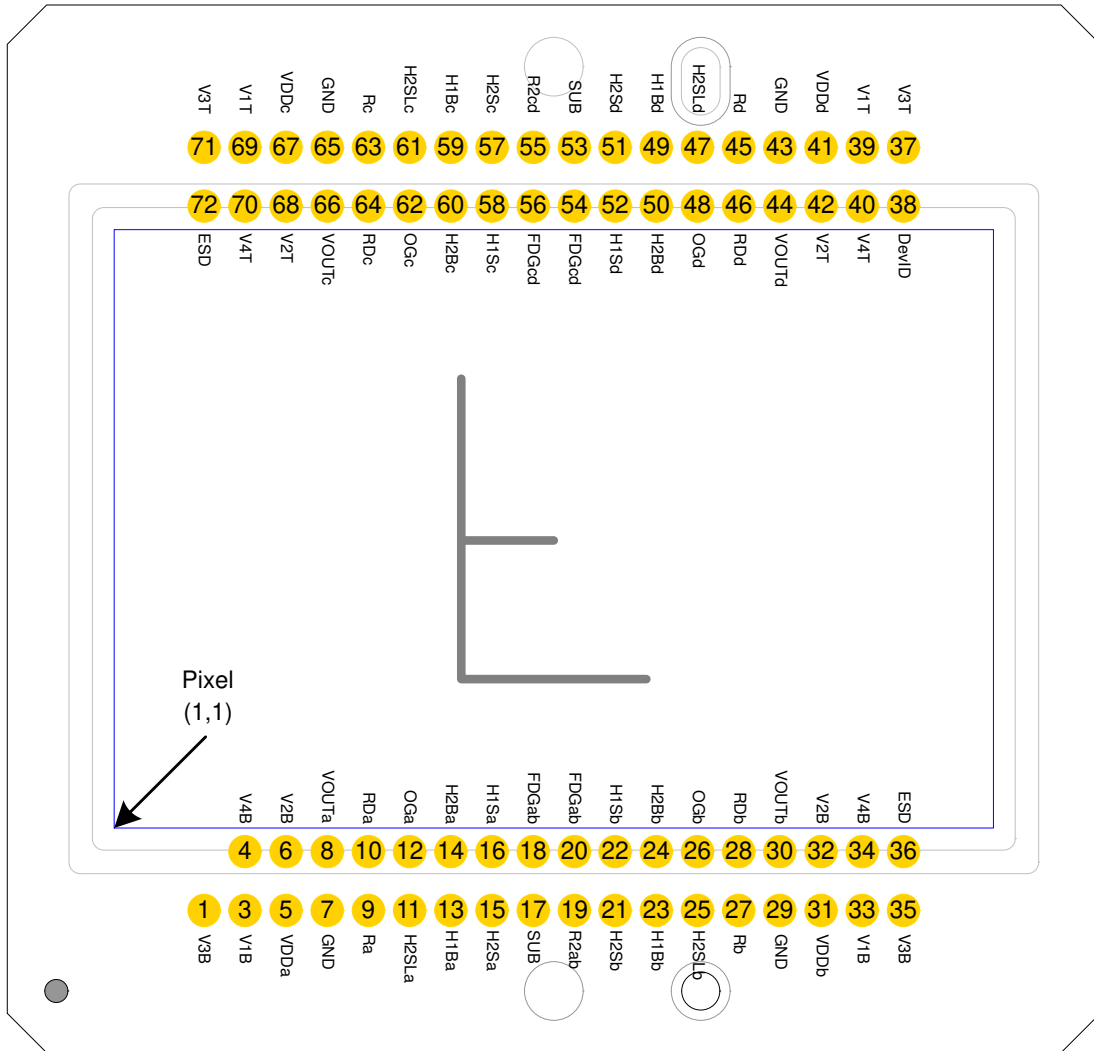

Figure 5. Package Pin Designations – Top View

Table 3. PIN DESCRIPTION

Pin	Name	Description
1	V3B	Vertical CCD Clock, Phase 3, Bottom
[2]		[No Pin – Keyed]
3	V1B	Vertical CCD Clock, Phase 1, Bottom
4	V4B	Vertical CCD Clock, Phase 4, Bottom
5	VDDa	Output Amplifier Supply, Quadrant a
6	V2B	Vertical CCD Clock, Phase 2, Bottom
7	GND	Ground
8	VOUTa	Video Output, Quadrant a
9	Ra	Reset Gate, Standard (High) Gain, Quadrant a
10	RDa	Reset Drain, Quadrant a
11	H2SLa	Horizontal CCD Clock, Phase 2, Storage, Last Phase, Quadrant a
12	OGa	Output Gate, Quadrant a
13	H1Ba	Horizontal CCD Clock, Phase 1, Barrier, Quadrant a
14	H2Ba	Horizontal CCD Clock, Phase 2, Barrier, Quadrant a
15	H2Sa	Horizontal CCD Clock, Phase 2, Storage, Quadrant a
16	H1Sa	Horizontal CCD Clock, Phase 1, Storage, Quadrant a
17	SUB	Substrate
18	FDGab	Fast Line Dump Gate, Bottom
19	R2ab	Reset Gate, Low Gain, Quadrants a & b
20	FDGab	Fast Line Dump Gate, Bottom
21	H2Sb	Horizontal CCD Clock, Phase 2, Storage, Quadrant b
22	H1Sb	Horizontal CCD Clock, Phase 1, Storage, Quadrant b
23	H1Bb	Horizontal CCD Clock, Phase 1, Barrier, Quadrant b
24	H2Bb	Horizontal CCD Clock, Phase 2, Barrier, Quadrant b
25	H2SLb	Horizontal CCD Clock, Phase 2, Storage, Last Phase, Quadrant b
26	OGb	Output Gate, Quadrant b
27	Rb	Reset Gate, Standard (High) Gain, Quadrant b
28	RDb	Reset Drain, Quadrant b
29	GND	Ground
30	VOUTb	Video Output, Quadrant b
31	VDDb	Output Amplifier Supply, Quadrant b
32	V2B	Vertical CCD Clock, Phase 2, Bottom
33	V1B	Vertical CCD Clock, Phase 1, Bottom
34	V4B	Vertical CCD Clock, Phase 4, Bottom
35	V3B	Vertical CCD Clock, Phase 3, Bottom
36	ESD	ESD Protection Disable

Pin	Name	Description
72	ESD	ESD Protection Disable
71	V3T	Vertical CCD Clock, Phase 3, Top
70	V4T	Vertical CCD Clock, Phase 4, Top
69	V1T	Vertical CCD Clock, Phase 1, Top
68	V2T	Vertical CCD Clock, Phase 2, Top
67	VDDc	Output Amplifier Supply, Quadrant c
66	VOUTc	Video Output, Quadrant c
65	GND	Ground
64	RDc	Reset Drain, Quadrant c
63	Rc	Reset Gate, Standard (High) Gain, Quadrant c
62	OGc	Output Gate, Quadrant c
61	H2SLc	Horizontal CCD Clock, Phase 2, Storage, Last Phase, Quadrant c
60	H2Bc	Horizontal CCD Clock, Phase 2, Barrier, Quadrant c
59	H1Bc	Horizontal CCD Clock, Phase 1, Barrier, Quadrant c
58	H1Sc	Horizontal CCD Clock, Phase 1, Storage, Quadrant c
57	H2Sc	Horizontal CCD Clock, Phase 2, Storage, Quadrant c
56	FDGcd	Fast Line Dump Gate, Top
55	R2cd	Reset Gate, Low Gain, Quadrants c & d
54	FDGcd	Fast Line Dump Gate, Top
53	SUB	Substrate
52	H1Sd	Horizontal CCD Clock, Phase 1, Storage, Quadrant d
51	H2Sd	Horizontal CCD Clock, Phase 2, Storage, Quadrant d
50	H2Bd	Horizontal CCD Clock, Phase 2, Barrier, Quadrant d
49	H1Bd	Horizontal CCD Clock, Phase 1, Barrier, Quadrant d
48	OGd	Output Gate, Quadrant d
47	H2SLd	Horizontal CCD Clock, Phase 2, Storage, Last Phase, Quadrant d
46	RDd	Reset Drain, Quadrant d
45	Rd	Reset Gate, Standard (High) Gain, Quadrant d
44	VOUTd	Video Output, Quadrant d
43	GND	Ground
42	V2T	Vertical CCD Clock, Phase 2, Top
41	VDDd	Output Amplifier Supply, Quadrant d
40	V4T	Vertical CCD Clock, Phase 4, Top
39	V1T	Vertical CCD Clock, Phase 1, Top
38	DevID	Device Identification
37	V3T	Vertical CCD Clock, Phase 3, Top

1. Liked named pins are internally connected and should have a common drive signal.

IMAGING PERFORMANCE

Table 4. TYPICAL OPERATION CONDITIONS

Unless otherwise noted, the Imaging Performance Specifications are measured using the following conditions.

Description	Condition	Notes
Light Source	Continuous red, green and blue LED illumination	For monochrome sensor, only green LED used.
Operation	Nominal operating voltages and timing	

Table 5. SPECIFICATIONS – ALL CONFIGURATIONS

Description	Symbol	Min.	Nom.	Max.	Units	Sampling Plan	Temperature Tested At (°C)	Notes
Dark Field Global Non-Uniformity	DSNU	–	–	5	mVpp	Die	27, 40	
Bright Field Global Non-Uniformity		–	2	12	%rms	Die	27, 40	1
Bright Field Global Peak to Peak Non-Uniformity	PRNU	–	10	30	%pp	Die	27, 40	1
Bright Field Center Non-Uniformity		–	1	2	%rms	Die	27, 40	1
Maximum Photo-response Nonlinearity High Gain (4,000 to 20,000 electrons) High Gain (4,000 to 40,000 electrons) Low Gain (8,000 to 80,000 electrons)	NL_HG1 NL_HG2 NL_LG1	– – –	2 3 6	– – –	%	Design		2
Maximum Gain Difference Between Outputs	ΔG	–	10	–	%	Design		2
Horizontal CCD Charge Capacity	HNe	–	90	–	ke ⁻	Design		
Vertical CCD Charge Capacity	VNe	–	60	–	ke ⁻	Design		
Photodiode Charge Capacity	PNe	–	44	–	ke ⁻	Die	27, 40	3
Floating Diffusion Capacity – High Gain	Fne_HG	40	–	–	ke ⁻	Die	27, 40	
Floating Diffusion Capacity – Low Gain	Fne_LG	160	–	–	ke ⁻	Die	27, 40	
Linear Saturation Level – High Gain	Lsat_HG	–	40	–	ke ⁻	Design		
Linear Saturation Level – Low Gain	Lsat_LG	–	160	–	ke ⁻	Design		
Horizontal CCD Charge Transfer Efficiency	HCTE	0.999995	0.999999	–		Die		
Vertical CCD Charge Transfer Efficiency	VCTE	0.999995	0.999999	–		Die		
Photodiode Dark Current	l _{pd}	–	2	70	e/p/s	Die	40	
Vertical CCD Dark Current	l _{vd}	–	200	600	e/p/s	Die	40	
Image Lag	Lag	–	–	10	e ⁻	Design		
Antiblooming Factor	Xab	1000	–	–		Design		
Vertical Smear	Smr	–	–115	–	dB	Design		
Read Noise (High Gain / Low Gain)	n _{e-T}	–	12 / 45	–	e ⁻ rms	Design		4
Dynamic Range, Standard	DR	–	70.5	–	dB	Design		4, 5
Dynamic Range, Extended Linear Dynamic Range Mode (XLDR)	XLDR	–	82.5	–	dB	Design		4, 5
Output Amplifier DC Offset	V _{odc}	5	9.0	14	V	Die	27, 40	
Output Amplifier Bandwidth	f _{-3db}	–	250	–	MHz	Design		6
Output Amplifier Impedance	R _{OUT}	100	127	200	Ω	Die	27, 40	
Output Amplifier Sensitivity High Gain Low Gain	$\Delta V/\Delta N$	– –	33 9.7	– –	μV/e ⁻	Design		

1. Per color
2. Value is over the range of 10% to 90% of photodiode saturation.
3. The operating value of the substrate voltage, VAB, will be marked on the shipping container for each device. The value of VAB is set such that the photodiode charge capacity is 1450 mV. This value is determined while operating the device in the low gain mode. VAB level assigned is valid for both modes; high gain or low gain.
4. At 40 MHz
5. Uses 20LOG (PNe/ n_{e-T})
6. Assumes 5 pF load.

KAI-16070

Table 6. KAI-16070-AAA CONFIGURATION WITH NO GLASS

Description	Symbol	Min.	Nom.	Max.	Units	Sampling Plan	Temperature Tested At (°C)	Notes
Peak Quantum Efficiency	QE _{max}	–	10	–	%	Design		1
Peak Quantum Efficiency Wavelength	λ _{QE}	–	500	–	nm	Design		1

1. Measurement taken without cover glass.

Table 7. KAI-16070-AXA, KAI-16070-PXA, AND KAI-16070-QXA CONFIGURATIONS

Description	Symbol	Min.	Nom.	Max.	Units	Sampling Plan	Temperature Tested At (°C)	Notes
Peak Quantum Efficiency	QE _{max}	–	48	–	%	Design		
Peak Quantum Efficiency Wavelength	λ _{QE}	–	500	–	nm	Design		

1. This color filter set configuration (Gen1) is not recommended for new designs.

Table 8. KAI-16070-FXA AND KAI-16070-QXA GEN2 COLOR CONFIGURATIONS WITH MAR GLASS

Description	Symbol	Min.	Nom.	Max.	Units	Sampling Plan	Temperature Tested At (°C)	Notes
Peak Quantum Efficiency	Blue Green Red	QE _{max}	– 40 40 34	–	%	Design		
Peak Quantum Efficiency Wavelength	Blue Green Red	λ _{QE}	– 460 535 605	–	nm	Design		

Table 9. KAI-16070-CXA AND KAI-16070-PXA GEN1 COLOR CONFIGURATIONS WITH MAR GLASS

Description	Symbol	Min.	Nom.	Max.	Units	Sampling Plan	Temperature Tested At (°C)	Notes
Peak Quantum Efficiency	Blue Green Red	QE _{max}	– 39 41 32	–	%	Design		1
Peak Quantum Efficiency Wavelength	Blue Green Red	λ _{QE}	– 470 540 620	–	nm	Design		1

1. This color filter set configuration (Gen1) is not recommended for new designs.

Linear Signal Range

High Gain

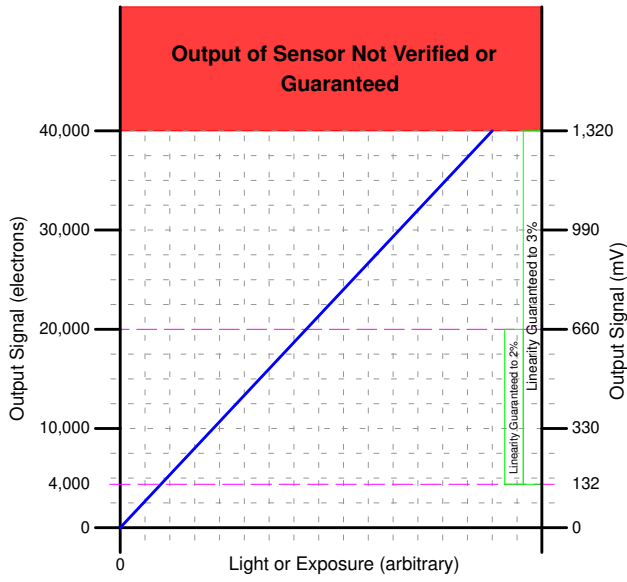

Figure 6. High Gain Linear Signal Range

Low Gain

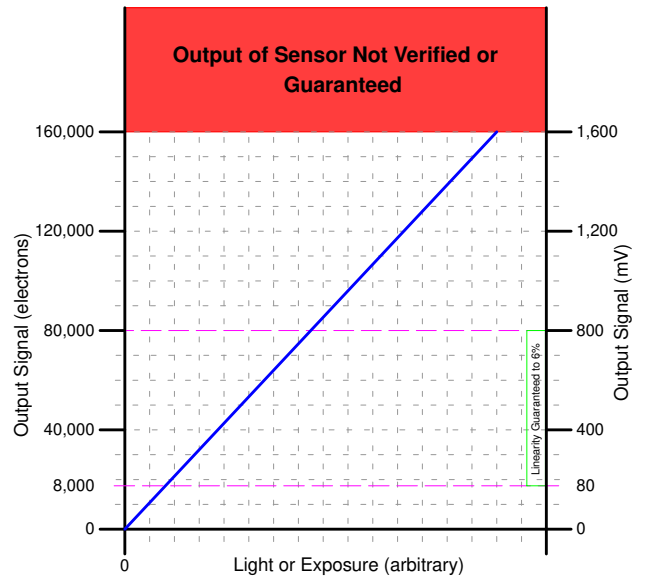

Figure 7. Low Gain Linear Signal Range

TYPICAL PERFORMANCE CURVES

Quantum Efficiency

Monochrome without Microlens

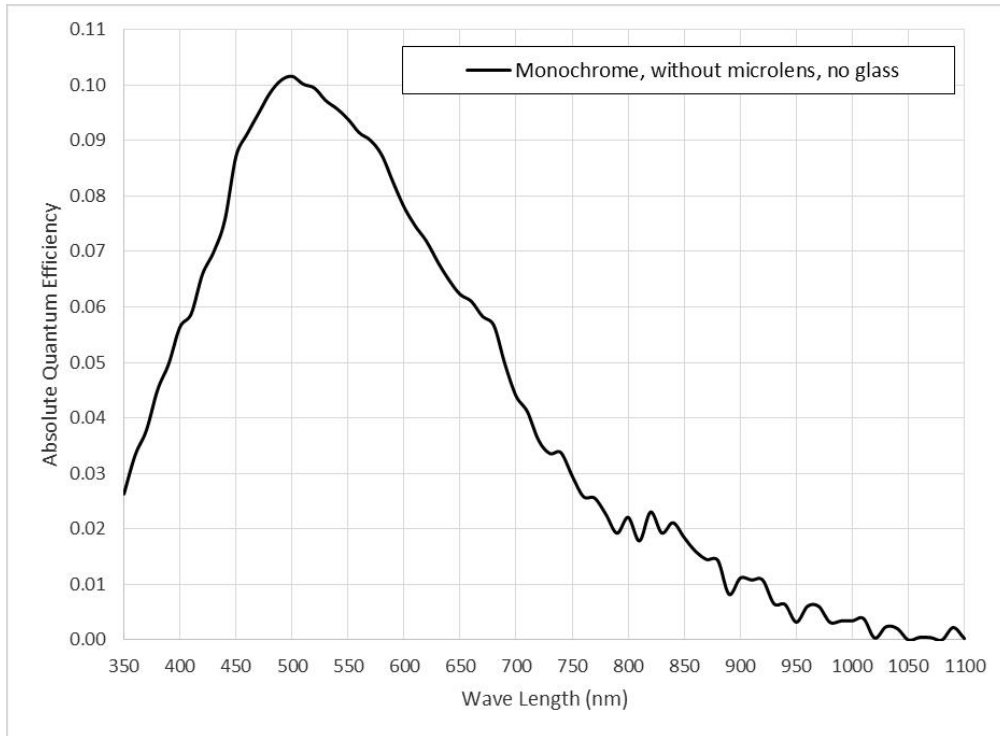

Figure 8. Monochrome without Microlens Quantum Efficiency

Monochrome with Microlens

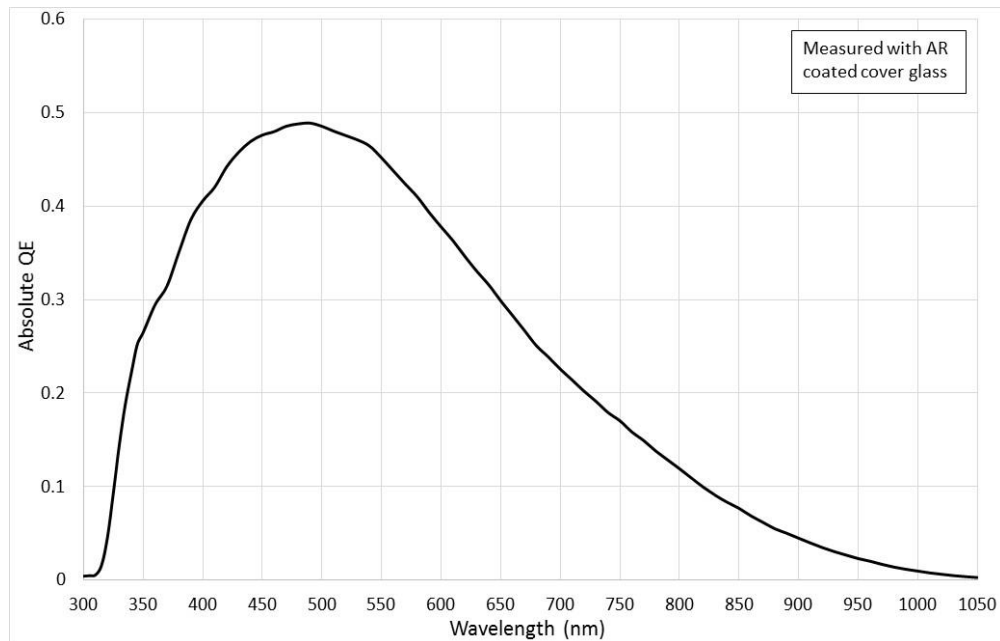

Figure 9. Monochrome with Microlens Quantum Efficiency

KAI-16070

Color (Bayer RGB) with Microlens (Gen2 and Gen1 CFA)

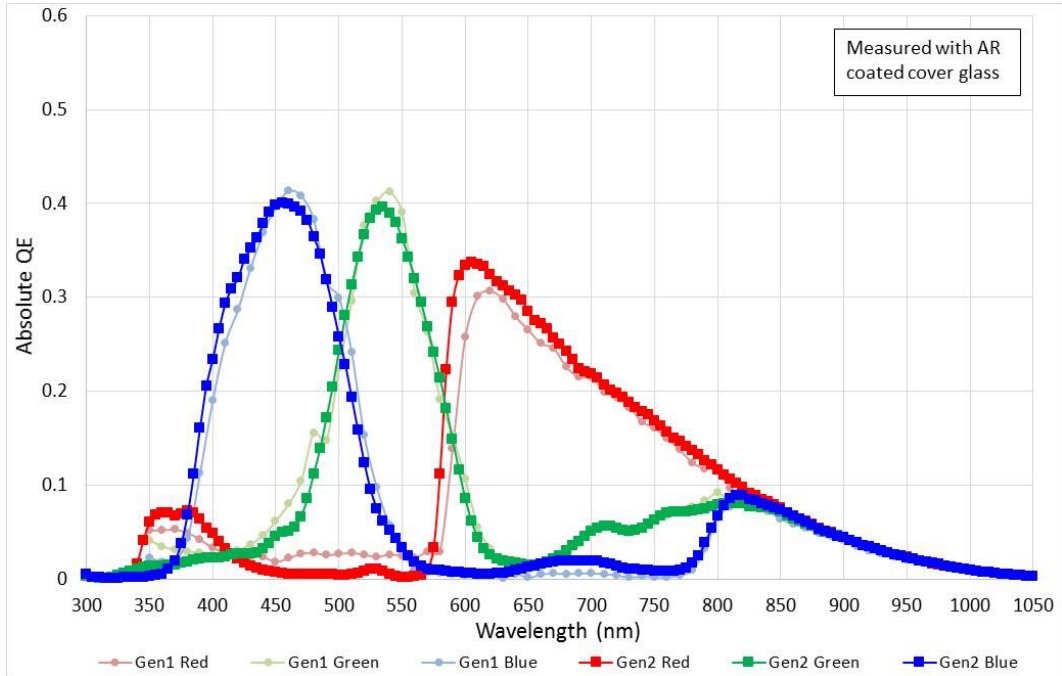

Figure 10. Color (Bayer) with Microlens Quantum Efficiency

Color (TRUESENSE Sparse CFA) with Microlens (Gen2 and Gen1 CFA)

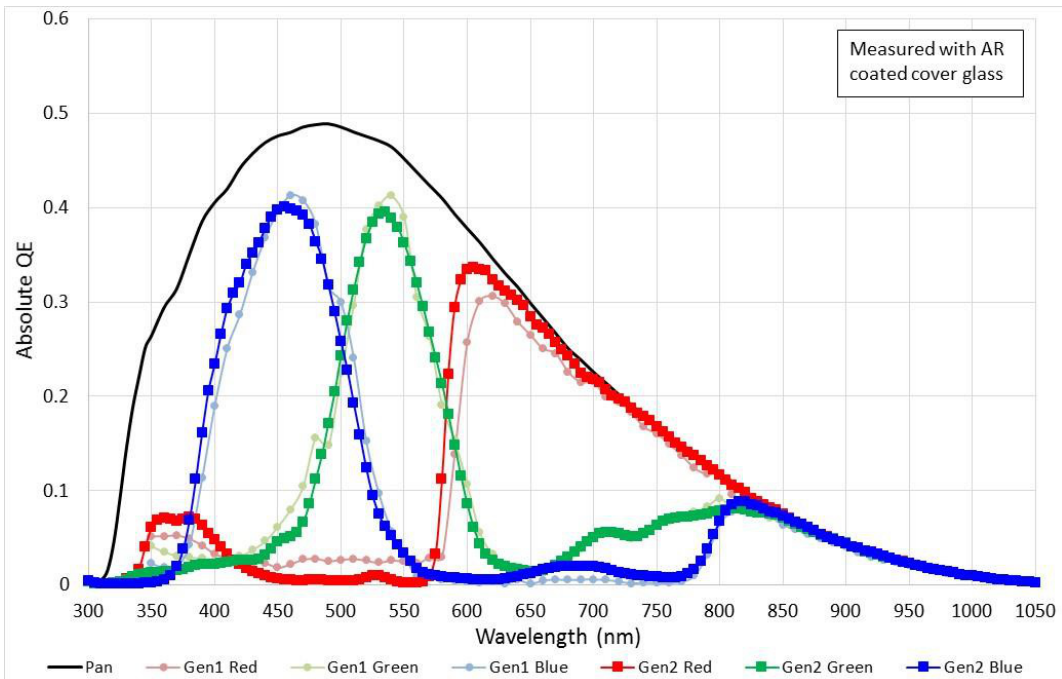

Figure 11. Color (TRUESENSE Sparse CFA) with Microlens Quantum Efficiency

Angular Quantum Efficiency

For the curves marked “Horizontal”, the incident light angle is varied in a plane parallel to the HCCD.

For the curves marked “Vertical”, the incident light angle is varied in a plane parallel to the VCCD.

Monochrome with Microlens

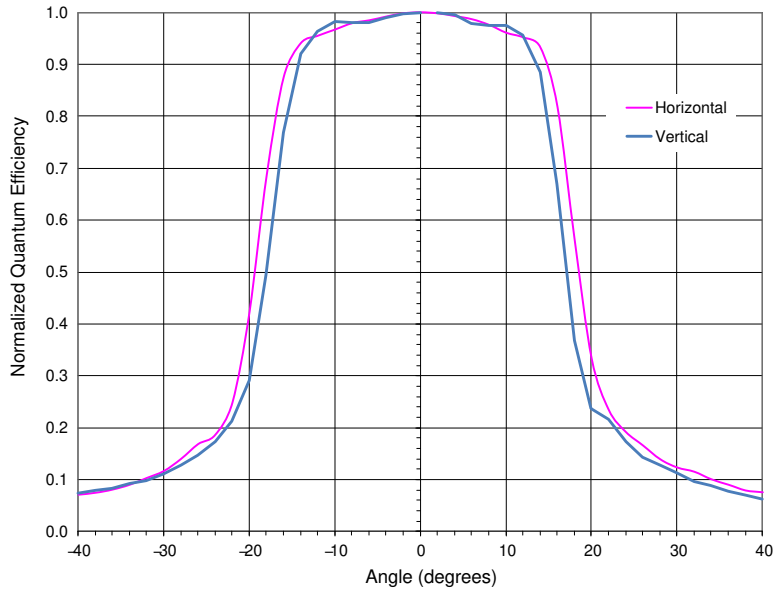

Figure 12. Monochrome with Microlens Angular Quantum Efficiency

Dark Current versus Temperature

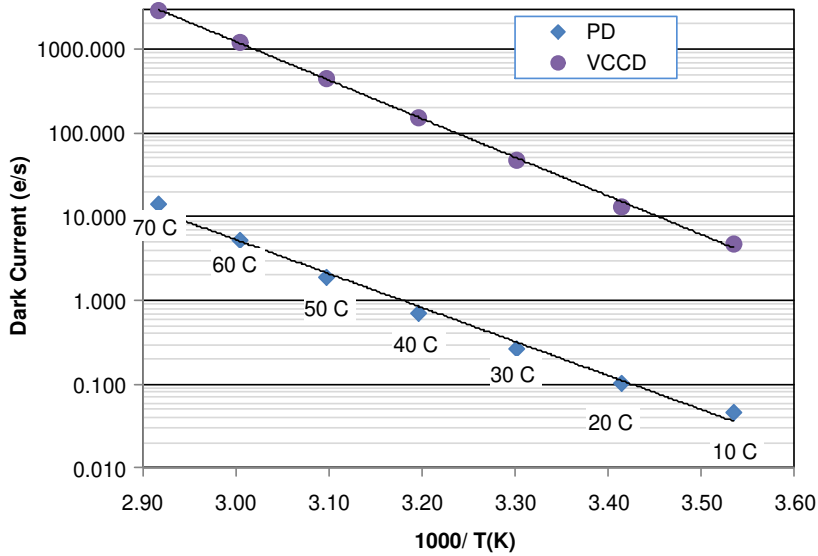

Figure 13. Dark Current versus Temperature

Power – Estimated

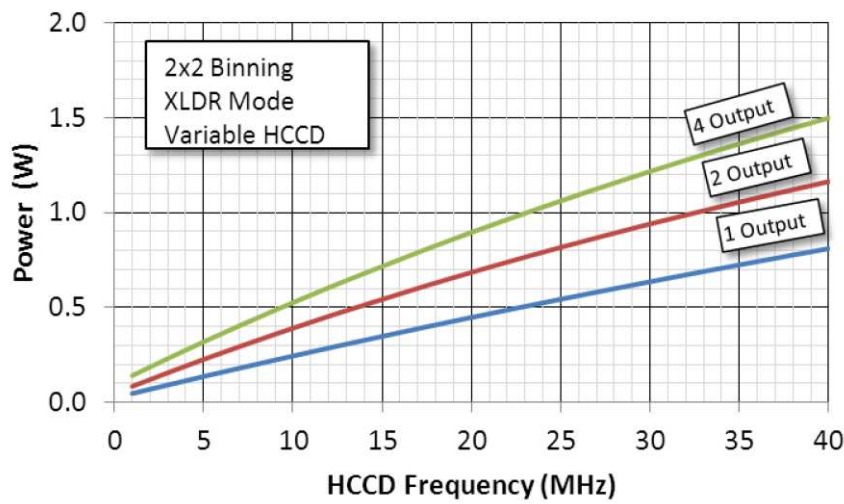
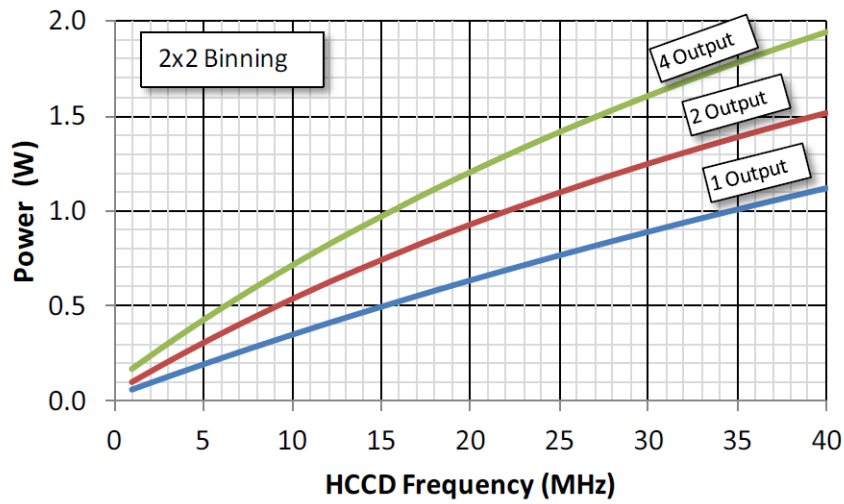
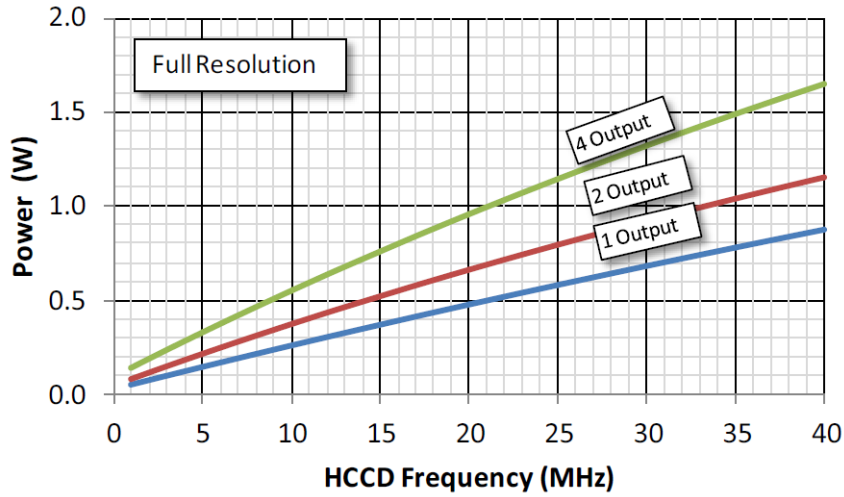

Figure 14. Power

Frame Rates

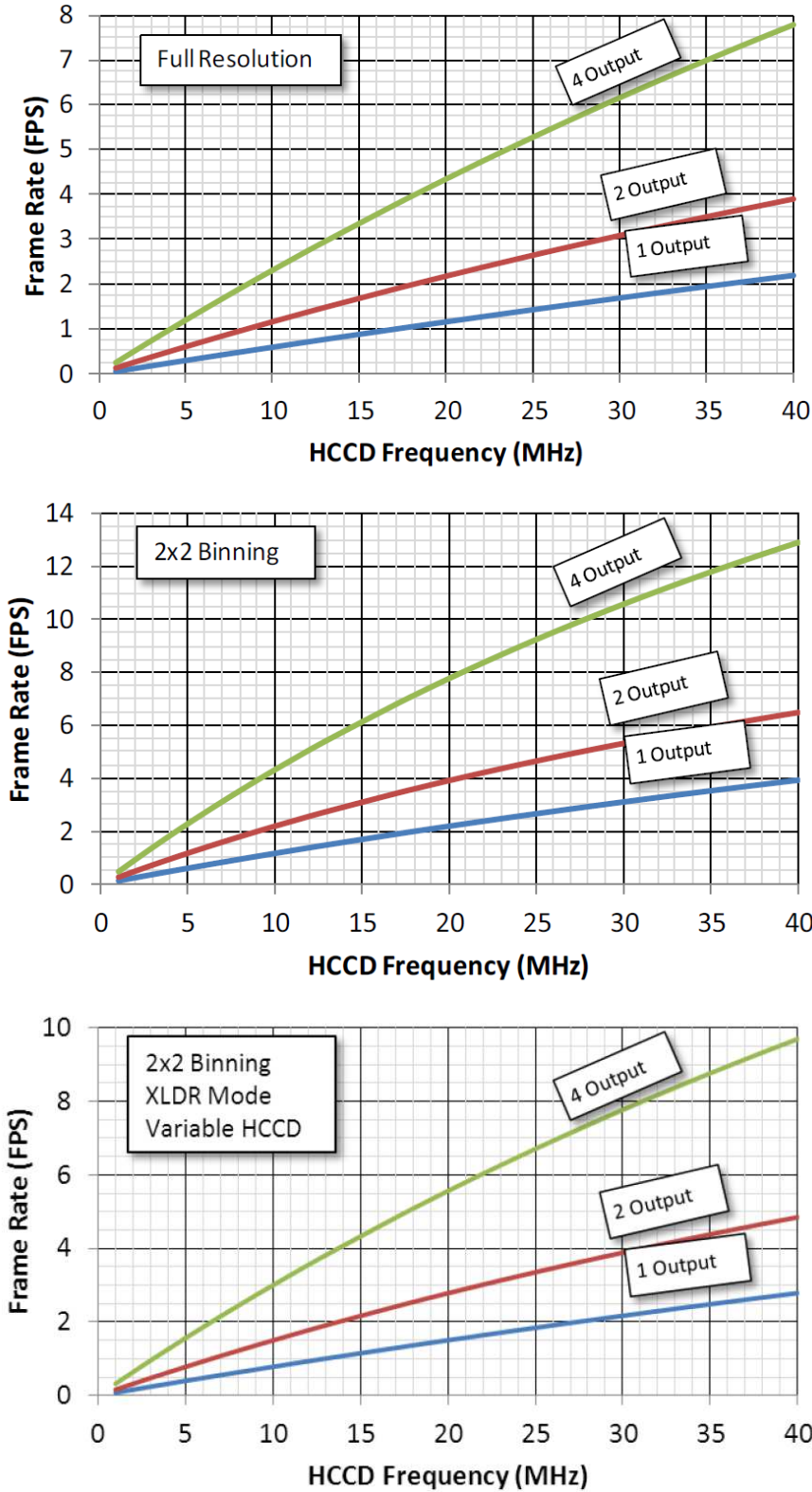

Figure 15. Frame Rates

DEFECT DEFINITIONS

Table 10. OPERATION CONDITIONS FOR DEFECT TESTING AT 40°C

Description	Condition	Notes
Operational Mode	One output using VOUTa, continuous readout	
HCCD Clock Frequency	20 MHz	
Pixels Per Line	5000	1
Lines Per Frame	3354	2
Line Time	266 μ sec	
Frame Time	894 msec	
Photodiode Integration Time	PD_Tint = Frame Time = 894 msec, no electronic shutter used	
Temperature	40°C	
Light Source	Continuous red, green and blue LED illumination	3
Operation	Nominal operating voltages and timing	

1. Horizontal overclocking used.
2. Vertical overclocking used.
3. For monochrome sensor, only the green LED is used.

Table 11. DEFECT DEFINITIONS FOR TESTING AT 40°C

Description	Definition	Grade 1	Grade 2 Mono	Grade 2 Color	Notes
Major dark field defective bright pixel	PD_Tint = Frame Time; Defect \geq 325 mV	150	300	300	1
Major bright field defective dark pixel	Defect \geq 15%				
Minor dark field defective bright pixel	PD_Tint = Frame Time; Defect \geq 163 mV	1500	3000	3000	
Cluster defect	A group of 2 to 19 contiguous major defective pixels, but no more than 4 adjacent defects horizontally.	30	30	30	2
Column defect	A group of more than 10 contiguous major defective pixels along a single column	0	4	15	2

1. For the color devices (KAI-16070-FXA, KAI-16070-QXA, KAI-16070-CXA, and KAI-16070-PXA), a bright field defective pixel deviates by 12% with respect to pixels of the same color.
2. Column and cluster defects are separated by no less than two (2) good pixels in any direction (excluding single pixel defects).
3. Tested at 40°C with no electronic shutter used.

Table 12. OPERATION CONDITIONS FOR DEFECT TESTING AT 27°C

Description	Condition	Notes
Operational Mode	Two outputs, using VOUTa and VOUTc, continuous readout	
HCCD Clock Frequency	20 MHz	
Pixels Per Line	5000	1
Lines Per Frame	3354	2
Line Time	266 μsec	
Frame Time	894 msec	
Photodiode Integration Time (PD_Tint)	PD_Tint = Frame Time = 894 msec, no electronic shutter used	
Temperature	27°C	
Light Source	Continuous red, green and blue LED illumination	3
Operation	Nominal operating voltages and timing	

1. Horizontal overclocking used.
2. Vertical overclocking used.
3. For monochrome sensor, only the green LED is used.

Table 13. DEFECT DEFINITIONS FOR TESTING AT 27°C

Description	Definition	Grade 1	Grade 2 Mono	Grade 2 Color	Notes
Major dark field defective bright pixel	PD_Tint = Frame Time → Defect ≥ 100 mV	150	300	300	1
Major bright field defective dark pixel	Defect ≥ 15%				
Minor dark field defective bright pixel	PD_Tint = Frame Time; Defect ≥ 52 mV	1500	3000	3000	
Cluster defect	A group of 2 to 19 contiguous major defective pixels, but no more than 4 adjacent defects horizontally.	30	30	30	2
Column defect	A group of more than 10 contiguous major defective pixels along a single column	0	4	15	2

1. For the color devices (KAI-16070-FXA, KAI-16070-QXA, KAI-16070-CXA, and KAI-16070-PXA), a bright field defective pixel deviates by 12% with respect to pixels of the same color.
2. Column and cluster defects are separated by no less than two (2) good pixels in any direction (excluding single pixel defects).
3. Tested at 27°C with no electronic shutter used.
4. Defectivity levels for a unit with the Taped Cover Glass configuration (non-sealed cover glass) of this device cannot be guaranteed after final testing at the factory. Image sensors are tested for defects and are mapped prior to shipment. Additional pixel defects and clusters may appear for devices purchased without a sealed cover glass.

Defect Map

The defect map supplied with each sensor is based upon testing at an ambient (27°C) temperature. Minor point

defects are not included in the defect map. All defective pixels are reference to pixel 1, 1 in the defect maps. See Figure 16: Regions of interest for the location of pixel 1,1.

TEST DEFINITIONS

Test Regions of Interest

Image Area ROI: Pixel (1, 1) to Pixel (4888, 3256)
 Active Area ROI: Pixel (13, 13) to Pixel (4876, 3244)
 Center ROI: Pixel (2345, 1527) to Pixel (2444, 1628)
 Only the Active Area ROI pixels are used for performance and defect tests.

Overclocking

The test system timing is configured such that the sensor is overclocked in both the vertical and horizontal directions.

See Figure 16 for a pictorial representation of the regions of interest.

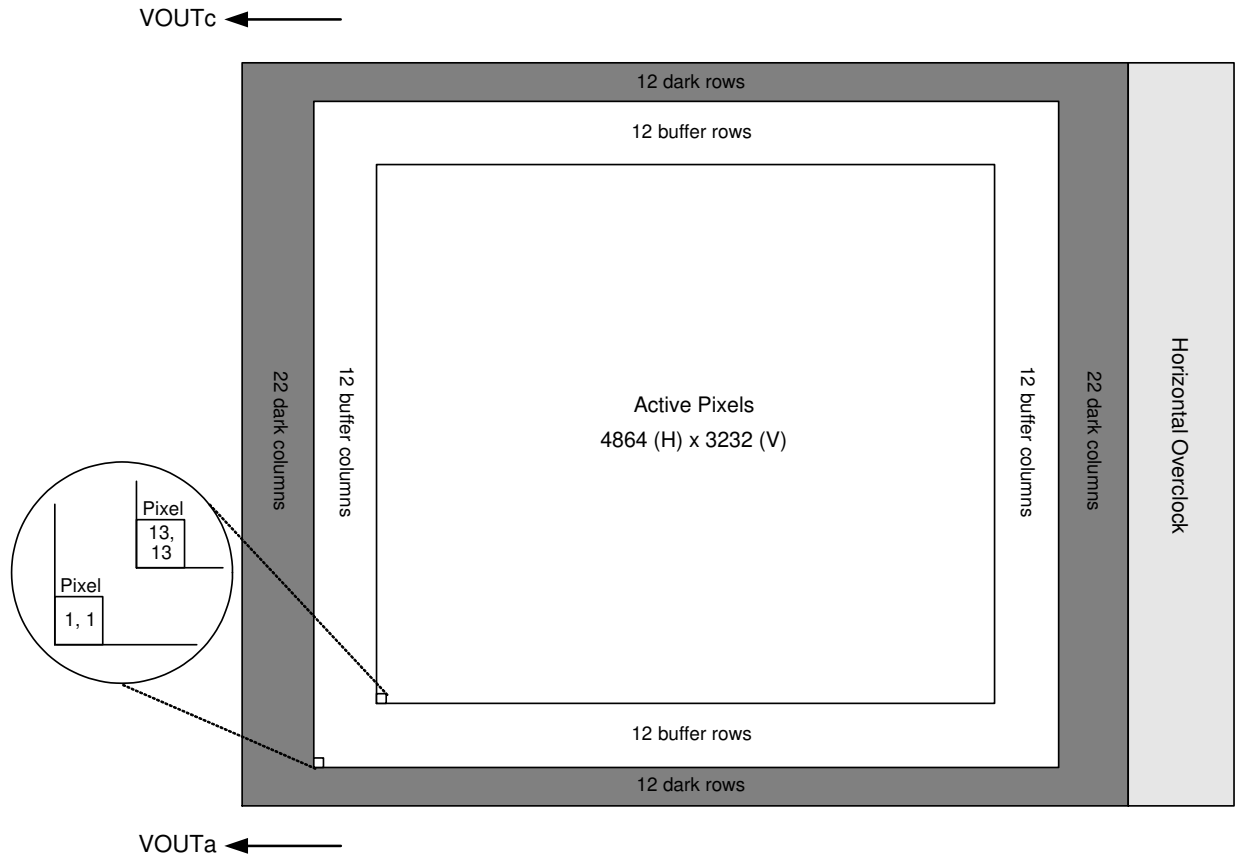

Figure 16. Regions of Interest

Tests

Dark Field Global Non-Uniformity

This test is performed under dark field conditions. The sensor is partitioned into 1 mm x 1 mm sub regions, each of which is 135 by 135 pixels in size. The average signal level of each of the sub regions of interest is calculated. The signal level of each of the sub regions of interest is calculated using the following formula:

Signal of ROI[i] = (ROI Average in counts – Horizontal overlock average in counts) * mV per count

Where i = 1 to total # of sub regions. During this calculation on the sub regions of interest, the maximum and

$$\text{GlobalNon-Uniformity} = 100 \times \left(\frac{\text{ActiveAreaStandardDeviation}}{\text{ActiveAreaSignal}} \right)$$

Units: %rms.

Active Area Signal = Active Area Average – Dark Column Average

Global Peak to Peak Non-Uniformity

This test is performed with the imager illuminated to a level such that the output is at 70% of saturation (approximately 924 mV). Prior to this test being performed the substrate voltage has been set such that the charge capacity of the sensor is 1320 mV. The sensor is partitioned into sub regions of interest, each of which is 135 by 135

$$\text{GlobalUniformity} = 100 \times \frac{\text{MaximumSignal} - \text{MinimumSignal}}{\text{ActiveAreaSignal}}$$

Units: %pp

Center Non-Uniformity

This test is performed with the imager illuminated to a level such that the output is at 70% of saturation (approximately 924 mV). Prior to this test being performed

$$\text{Center ROI Uniformity} = 100 \times \left(\frac{\text{Center ROI Standard Deviation}}{\text{Center ROI Signal}} \right)$$

Units: %rms.

Center ROI Signal = Center ROI Average – Dark Column Average

Dark Field Defect Test

This test is performed under dark field conditions. The sensor is partitioned into 1 mm x 1 mm sub regions, each of which is 135 by 135 pixels in size. In each region of interest, the median value of all pixels is found. For each region of interest, a pixel is marked defective if it is greater than or equal to the median value of that region of interest plus the defect threshold specified in the “Defect Definitions” section.

Bright Field Defect Test

This test is performed with the imager illuminated to a level such that the output is at approximately 924 mV. Prior

minimum signal levels are found. The dark field global uniformity is then calculated as the maximum signal found minus the minimum signal level found.

Units: mVpp (millivolts peak to peak)

Global Non-Uniformity

This test is performed with the imager illuminated to a level such that the output is at 70% of saturation (approximately 924 mV). Prior to this test being performed the substrate voltage has been set such that the charge capacity of the sensor is 1320 mV. Global non-uniformity is defined as

pixels in size. The average signal level of each of the before mentioned sub regions of interest (ROI) is calculated. The signal level of each of the sub regions of interest is calculated using the following formula:

Signal of ROI[i] = (ROI Average in counts – Horizontal overlock average in counts) * mV per count

Where i = 1 to total # of sub regions. During this calculation on the sub regions of interest, the maximum and minimum signal levels are found. The global peak to peak uniformity is then calculated as:

the substrate voltage has been set such that the charge capacity of the sensor is 1320 mV. Defects are excluded for the calculation of this test. This test is performed on the center 100 by 100 pixels of the sensor. Center uniformity is defined as:

to this test being performed the substrate voltage has been set such that the charge capacity of the sensor is 1320 mV. The average signal level of all active pixels is found. The bright and dark thresholds are set as:

Dark defect threshold = Active Area Signal * threshold
Bright defect threshold = Active Area Signal * threshold

The sensor is then partitioned into 1 mm x 1 mm sub regions of interest, each of which is 135 by 135 pixels in size. In each region of interest, the average value of all pixels is found. For each region of interest, a pixel is marked defective if it is greater than or equal to the median value of that region of interest plus the bright threshold specified or if it is less than or equal to the median value of that region of interest minus the dark threshold specified.

Example for major bright field defective pixels:

- Average value of all active pixels is found to be 924 mV
- Dark defect threshold: $924 \text{ mV} * 15\% = 138 \text{ mV}$
- Bright defect threshold: $924 \text{ mV} * 15\% = 138 \text{ mV}$
- Region of interest #1 selected. This region of interest is pixels 13, 13 to pixels 147, 147.
 - ◆ Median of this region of interest is found to be 918 mV.
 - ◆ Any pixel in this region of interest that is $\geq (918 + 138 \text{ mV}) 1062 \text{ mV}$ in intensity will be marked defective.
 - ◆ Any pixel in this region of interest that is $\leq (918 - 138 \text{ mV}) 780 \text{ mV}$ in intensity will be marked defective.
- All remaining sub regions of interest are analyzed for defective pixels in the same manner. Any remaining factor of pixels less than 135 pixels that are not covered by this moving ROI is placed over the remaining pixels at the active area boundary. A portion of pixels that were tested in the previous ROI will be retested to keep the test ROI at a full 135 by 135 pixels.

OPERATION

Table 14. ABSOLUTE MAXIMUM RATINGS

Description	Symbol	Minimum	Maximum	Units	Notes
Operating Temperature	T _{OP}	-50	+70	°C	1
Humidity	RH	+5	+90	%	2
Output Bias Current	I _{out}		60	mA	3
Off-chip Load	C _L		10	pF	

Stresses exceeding those listed in the Maximum Ratings table may damage the device. If any of these limits are exceeded, device functionality should not be assumed, damage may occur and reliability may be affected.

- Noise performance will degrade at higher temperatures.
- T = 25°C. Excessive humidity will degrade MTTF.
- Total for all outputs. Maximum current is -15 mA for each output. Avoid shorting output pins to ground or any low impedance source during operation. Amplifier bandwidth increases at higher current and lower load capacitance at the expense of reduced gain (sensitivity).

Table 15. ABSOLUTE MAXIMUM VOLTAGE RATINGS BETWEEN PINS AND GROUND

Description	Minimum	Maximum	Units	Notes
VDD _α , VOUT _α	-0.4	17.5	V	1
RD _α	-0.4	15.5	V	1
V1B, V1T	ESD - 0.4	ESD + 24.0	V	
V2B, V2T, V3B, V3T, V4B, V4T	ESD - 0.4	ESD + 14.0	V	
FDG _{ab} , FDG _{cd}	ESD - 0.4	ESD + 14.0	V	
H1S _α , H1B _α , H2S _α , H2B _α , H2SL _α , R _α , OG _α	ESD - 0.4	ESD + 14.0	V	1
ESD	-10.0	0.0	V	
SUB	-0.4	+40.0	V	2

- α denotes a, b, c or d
- Refer to Application Note *Using Interline CCD Image Sensors in High Intensity Visible Lighting Conditions*.

KAI-29050 Compatibility

The KAI-16070 is pin-for-pin compatible with a camera designed for the KAI-29050 image sensor with the following accommodations:

- To operate in accordance with a system designed for KAI-29050, the target substrate voltage should be set to be 2.0 V higher than the value recorded on the KAI-16070 shipping container. This setting will cause the charge capacity to be limited to 20 Ke⁻ (or 660 mV).
- On the KAI-16070, pins 19 (R2ab) and 55 (R2cd) should be left floating per the KAI-29050 Device Performance Specification.
- The KAI-16070 will operate in only the high gain mode (33 μV/e).
- All timing and voltages are taken from the KAI-29050 specification sheet.

- The number of horizontal and vertical CCD clock cycles is reduced as appropriate.
- In addition, if the intent is to operate the KAI-16070 image sensor in a camera designed for the KAI-29050 sensor that has been modified to accept and process the full 40,000 e⁻ (1,320 mV) output, the following changes to the following voltage bias must be made:

Voltage Bias Differences	KAI-29050	KAI-16070
Pins 10, 28, 46, and 64	12.0 V per the specification	Increase this value to 12.6 V

NOTE: To make use of the low gain mode or dual gain mode the KAI-16070 voltages and timing specification must be used.

Reset Pin, Low Gain (R2ab and R2cd)

The R2ab and R2bc (pins 19 and 55) each have an internal circuit to bias the pins to 4.3 V. This feature assures the device is set to operate in the high gain mode when pins 19

and 55 are not connected in the application to a clock driver (for KAI-29050 compatibility). Typical capacitor coupled drivers will not drive this structure.

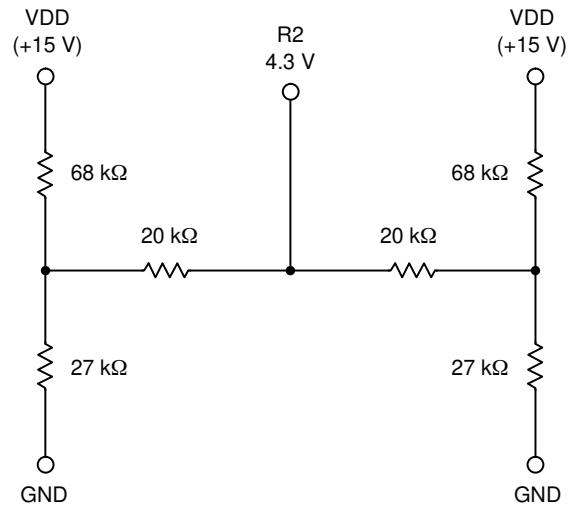

Figure 17. Equivalent Circuit for Reset Gate, Low Gain (R2ab and R2cd)

Power-Up and Power-Down Sequence

Adherence to the power-up and power-down sequence is critical. Failure to follow the proper power-up and power-down sequences may cause damage to the sensor.

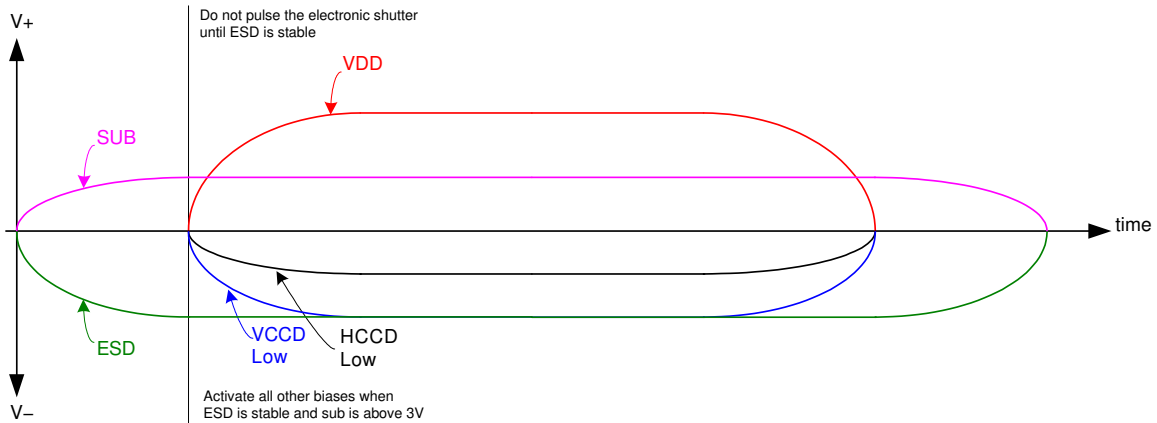

Figure 18. Power-Up and Power-Down Sequence

Notes:

7. Activate all other biases when ESD is stable and SUB is above 3 V
8. Do not pulse the electronic shutter until ESD is stable
9. VDD cannot be +15 V when SUB is 0 V
10. The image sensor can be protected from an accidental improper ESD voltage by current limiting the SUB current to less than 10 mA. SUB and VDD must always be greater than GND. ESD must always be less than GND. Placing diodes between SUB, VDD, ESD and ground will protect the sensor from accidental overshoots of SUB, VDD and ESD during power on and power off. See the figure below.

The VCCD clock waveform must not have a negative overshoot more than 0.4 V below the ESD voltage.

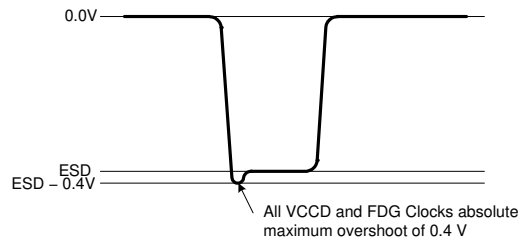

Figure 19.

Example of external diode protection for SUB, VDD and ESD. α denotes a, b, c or d

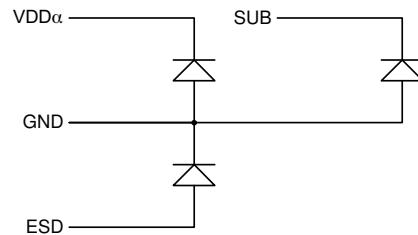

Figure 20.

Table 16. DC BIAS OPERATING CONDITIONS

Description	Pins	Symbol	Minimum	Nominal	Maximum	Units	Maximum DC Current	Notes
Reset Drain	RD α	RD	+12.4	+12.6	+12.8	V	10 μ A	1, 9
Output Gate	OG α	OG	-2.2	-2.0	-1.8	V	10 μ A	1
Output Amplifier Supply	VDD α	VDD	+14.5	+15.0	+15.5	V	11.0 mA	1,2
Ground	GND	GND	0.0	0.0	0.0	V	-1.0 mA	
Substrate	SUB	VSUB	+5.0	VAB	VDD	V	50 μ A	3, 8
ESD Protection Disable	ESD	ESD	-9.5	-9.0	V _{x_L}	V	50 μ A	6, 7, 10
Output Bias Current	VOU α	I _{out}	-3.0	-5.0	-10.0	mA		1, 4, 5

- α denotes a, b, c or d
- The maximum DC current is for one output. I_{dd} = I_{out} + I_{ss}. See Figure 21.
- The operating value of the substrate voltage, VAB, will be marked on the shipping container for each device. The value of VAB is set such that the photodiode charge capacity is the nominal PNe (see Specifications).
- An output load sink must be applied to each VOUT pin to activate each output amplifier.
- Nominal value required for 40 MHz operation per output. May be reduced for slower data rates and lower noise.
- Adherence to the power-up and power-down sequence is critical. See Power-Up and Power-Down Sequence section.
- ESD maximum value must be less than or equal to V1_L + 0.4 V and V2_L + 0.4 V
- Refer to Application Note *Using Interline CCD Image Sensors in High Intensity Visible Lighting Conditions*
- 12.0 V may be used if the total output signal desired is 20,000 e⁻ or less.
- Where V_{x_L} is the level set for V1_L, V2_L, V3_L, or V4_L in the application.

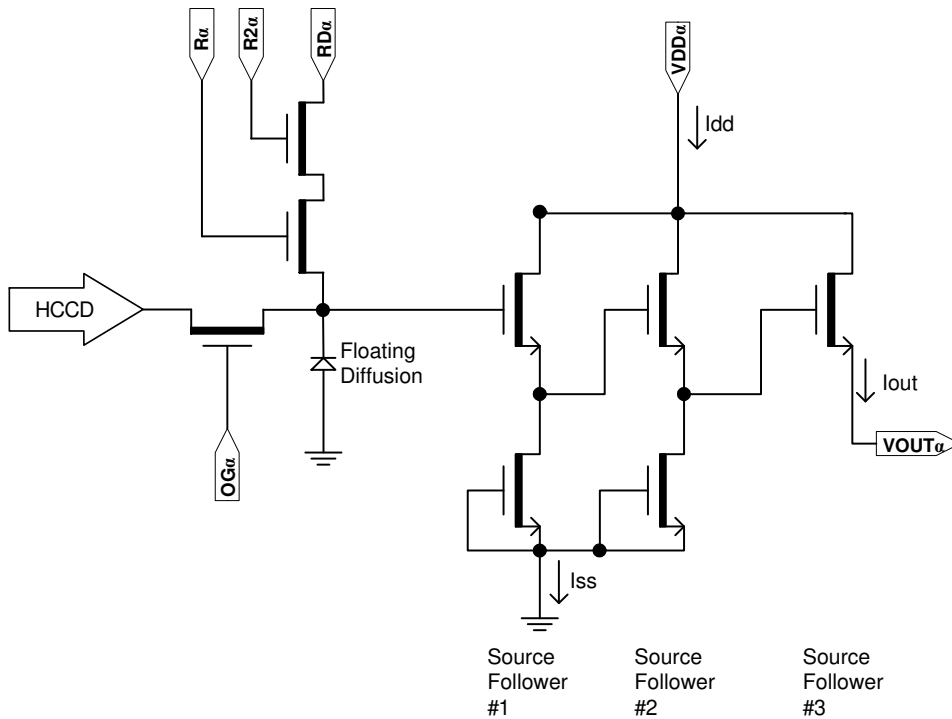

Figure 21. Output Amplifier – Showing Dual Reset Pins

AC Operating Conditions

Table 17. CLOCK LEVELS

Description	Pins	Symbol	Level	Minimum	Nominal	Maximum	Units
Vertical CCD Clock, Phase 1	V1B, V1T ¹	V1_L	Low	-8.2	-8.0	-7.8	V
		V1_M	Mid	-0.2	0.0	+0.2	
		V1_H	High	+12.8	+13.0	+14.0	
Vertical CCD Clock, Phase 2	V2B, V2T ¹	V2_L	Low	-8.2	-8.0	-7.8	V
		V2_H	High	-0.2	0.0	+0.2	
Vertical CCD Clock, Phase 3	V3B, V3T ¹	V3_L	Low	-8.2	-8.0	-7.8	V
		V3_H	High	-0.2	0.0	+0.2	
Vertical CCD Clock, Phase 4	V4B, V4T ¹	V4_L	Low	-8.2	-8.0	-7.8	V
		V4_H	High	-0.2	0.0	+0.2	
Horizontal CCD Clock, Phase 1 Storage	H1S α ¹	H1S_L	Low	-5.0 (5)	-4.4	-4.2	V
		H1S_A	Amplitude	+4.2	+4.4	+5.0 (5)	
Horizontal CCD Clock, Phase 1 Barrier	H1B α ¹	H1B_L	Low	-5.0 (5)	-4.4	-4.2	V
		H1B_A	Amplitude	+4.2	+4.4	+5.0 (5)	
Horizontal CCD Clock, Phase 2 Storage	H2S α ¹	H2S_L	Low	-5.0 (5)	-4.4	-4.2	V
		H2S_A	Amplitude	+4.2	+4.4	+5.0 (5)	
Horizontal CCD Clock, Phase 2 Barrier	H2B α ¹	H2B_L	Low	-5.0 (5)	-4.4	-4.2	V
		H2B_A	Amplitude	+4.2	+4.4	+5.0 (5)	
Horizontal CCD Clock, Last Phase ²	H2SL α ¹	H2SL_L	Low	-5.2	-5.0	-4.8	V
		H2SL_A	Amplitude	+4.8	+5.0	+5.2	
Reset Gate	R α ¹	R_L ³	Low	-3.2	-3.0	-2.8	V
		R_A	Amplitude	+6.0		+6.4	
Reset Gate	R2ab, R2cd	R_L ³	Low	-2.0	-1.8	-1.6	V
		R_A	Amplitude	+6.0		+6.4	
Electronic Shutter ⁴	SUB	VES	High	+29.0	+30.0	+40.0	V
Fast Line Dump Gate	FDG α ¹	FDG_L	Low	-8.2	-8.0	-7.8	V
		FDG_H	High	+4.5	+5.0	+5.5	

- α denotes a, b, c or d
- Use separate clock driver for improved speed performance.
- Reset low should be set to -3 volts for signal levels greater than 40,000 electrons.
- Refer to Application Note *Using Interline CCD Image Sensors in High Intensity Visible Lighting Conditions*
- If the minimum horizontal clock low level is used (-5.0 V), then the maximum horizontal clock amplitude should be used (5 V amplitude) to create a -5.0 V to 0.0 V clock.

The figure below shows the DC bias (V_{SUB}) and AC clock (VES) applied to the SUB pin. Both the DC bias and AC clock are referenced to ground.

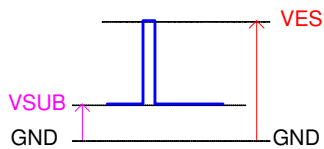

Figure 22.

KAI-16070

Capacitance

Table 18. CAPACITANCE

	V1B	V2B	V3B	V4B	V1T	V2T	V3T	V4T	GND	All Pins	Units
V1B	X	17	11	14	6	5	6	4	24	88	nF
V2B	X	X	21	10	5	3	4	3	7	74	nF
V3B	X	X	X	19	6	5	6	4	8	83	nF
V4B	X	X	X	X	5	4	5	3	23	76	nF
V1T	X	X	X	X	X	14	11	17	24	86	nF
V2T	X	X	X	X	X	X	16	6	22	75	nF
V3T	X	X	X	X	X	X	X	19	11	84	nF
V4T	X	X	X	X	X	X	X	X	5	73	nF
FDGT	0.6	0.5	0.5	0.4	16	3.1	1.0	1.1	94	117	pF
FDGB	0.6	0.5	0.5	0.4	16	3.1	1.0	1.1	94	117	pF
VSUB	2	2	2	2	2	2	2	2	11	11	nF

	H2S	H1B	H2B	GND	All Pins	Units
H1S	45	75	44	196	360	pF
H2S	X	47	41	281	368	pF
H1B	X	X	12	313	324	pF
H2B	X	X	X	293	293	pF

1. Tables show typical cross capacitance between pins of the device.
2. Capacitance is total for all like named pins.