



Chipsmall Limited consists of a professional team with an average of over 10 year of expertise in the distribution of electronic components. Based in Hongkong, we have already established firm and mutual-benefit business relationships with customers from,Europe,America and south Asia,supplying obsolete and hard-to-find components to meet their specific needs.

With the principle of "Quality Parts,Customers Priority,Honest Operation,and Considerate Service",our business mainly focus on the distribution of electronic components. Line cards we deal with include Microchip,ALPS,ROHM,Xilinx,Pulse,ON,Everlight and Freescale. Main products comprise IC,Modules,Potentiometer,IC Socket,Relay,Connector.Our parts cover such applications as commercial,industrial, and automotives areas.

We are looking forward to setting up business relationship with you and hope to provide you with the best service and solution. Let us make a better world for our industry!



Contact us

Tel: +86-755-8981 8866 Fax: +86-755-8427 6832

Email & Skype: info@chipsmall.com Web: www.chipsmall.com

Address: A1208, Overseas Decoration Building, #122 Zhenhua RD., Futian, Shenzhen, China



SERIES KAR SWITCHES

PIANO DIP SWITCHES



SPECIFICATIONS

Switch Function:	SPST, 1 thru 12 positions (excluding position 11)
Contact Rating:	Switch: 25mA @24VDC; Carry: 100mA @50VDC
Insulation Resistance:	1,000 Megaohms min @ 100VDC
Contact Resistance:	Initial: 50 milliohms max After Life: 100 milliohms max
Mechanical Life:	2000 make-and-break cycles, each circuit
Operating Force:	500gf max
Dielectric Strength:	500 VAC for 60 seconds
Storage Temperature:	-40C to +85C
Operating Temperature:	-30C to +85C

FEATURES & BENEFITS

- Process sealed option
- SMT termination option
- Low profile actuator

APPLICATIONS / MARKETS

- Garage door openers
- Controller applications
- Telecommunications
- Testing/instrumentation

MATERIALS

Base & Cover:	PPS, UL94-V0
Actuator:	Nylon, UL94-V0
Movable Contacts:	Copper alloy with gold over tin plate
Terminal Contacts:	Brass with gold over tin plate

PACKAGING

Switches are supplied with all poles in the "OFF" position.

HOW TO ORDER

SERIES	MODEL NO.	NO. of POSITIONS	ACTUATOR ("L" Dimension)	TERMINATION	TERMINAL FINISH	PACKAGING
KA	<input type="checkbox"/>	<input type="checkbox"/>	<input type="checkbox"/>	<input type="checkbox"/>	<input type="checkbox"/>	<input type="checkbox"/>
	R = Low Profile	02 = 2 03 = 3 04 = 4 05 = 5 06 = 6 08 = 8 10 = 10 12 = 12	L = Extended S = Low Profile (w/o tape seal)	A = Splayed Pins H = Straight Pins J = J-Leads G = Gull Wing	G = Gold	T = Std. Tube Qty. (Pin Termination) R = Tape & Reel (SMT Termination only)

Example Ordering Number:

KA R 08 S H G R

Specifications subject to change without notice.

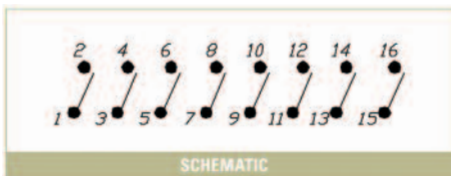

Number of Positions mm (inch)	2	3	4	5	6	7	8	9	10	12
"A" Dimension (+/- 0.3mm)	6.08 (0.23)	8.72 (0.34)	11.90 (0.46)	14.44 (0.56)	16.98 (0.66)	19.52 (0.76)	22.06 (0.86)	24.60 (0.96)	27.14 (1.06)	32.33 (1.268)
"B" Dimension (+/- 0.2mm)	2.54 (0.10)	5.08 (0.20)	7.62 (0.30)	10.16 (0.40)	12.7 (0.50)	15.24 (0.60)	17.78 (0.70)	20.32 (0.80)	22.86 (0.90)	27.94 (1.10)

SERIES KAR SWITCHES



Through Hole Termination Options

SPLAYED PIN TERMINATION - "A"

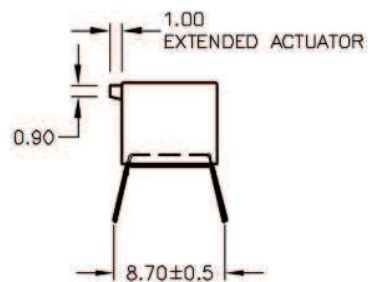
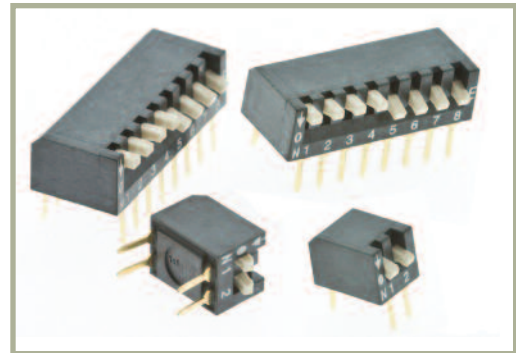
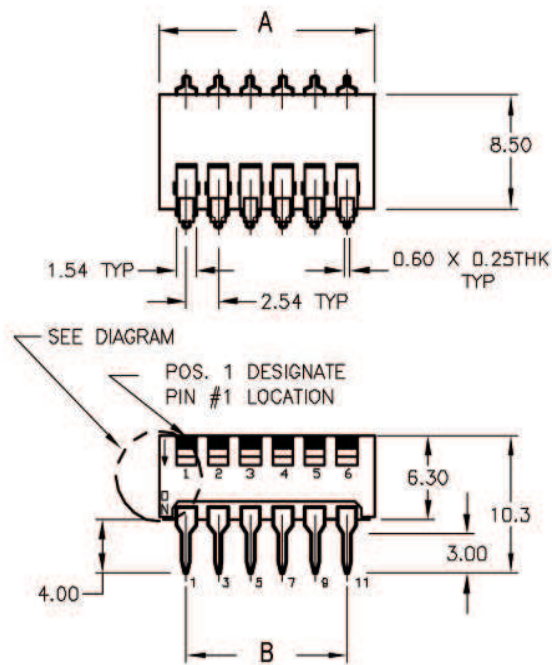

STRAIGHT PIN TERMINATION - "H"

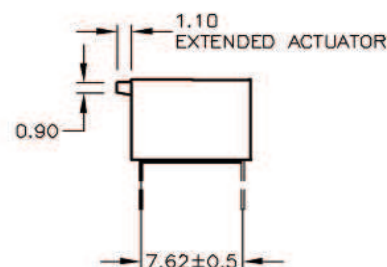
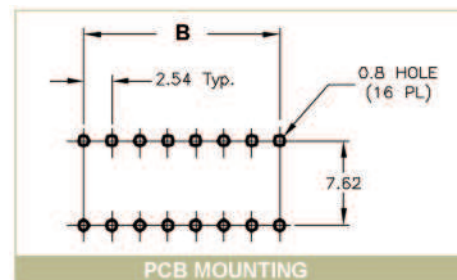
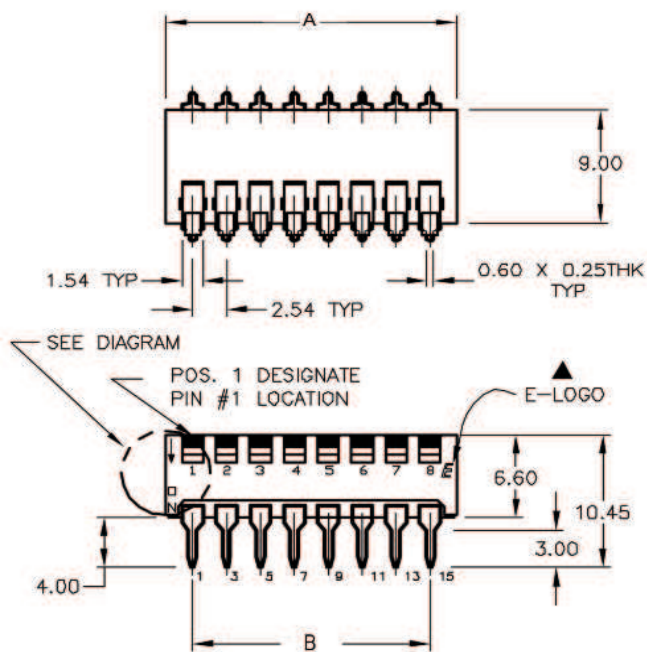

SERIES KAR SWITCHES



SMT Termination Options

J-LEAD TERMINATION - "J"

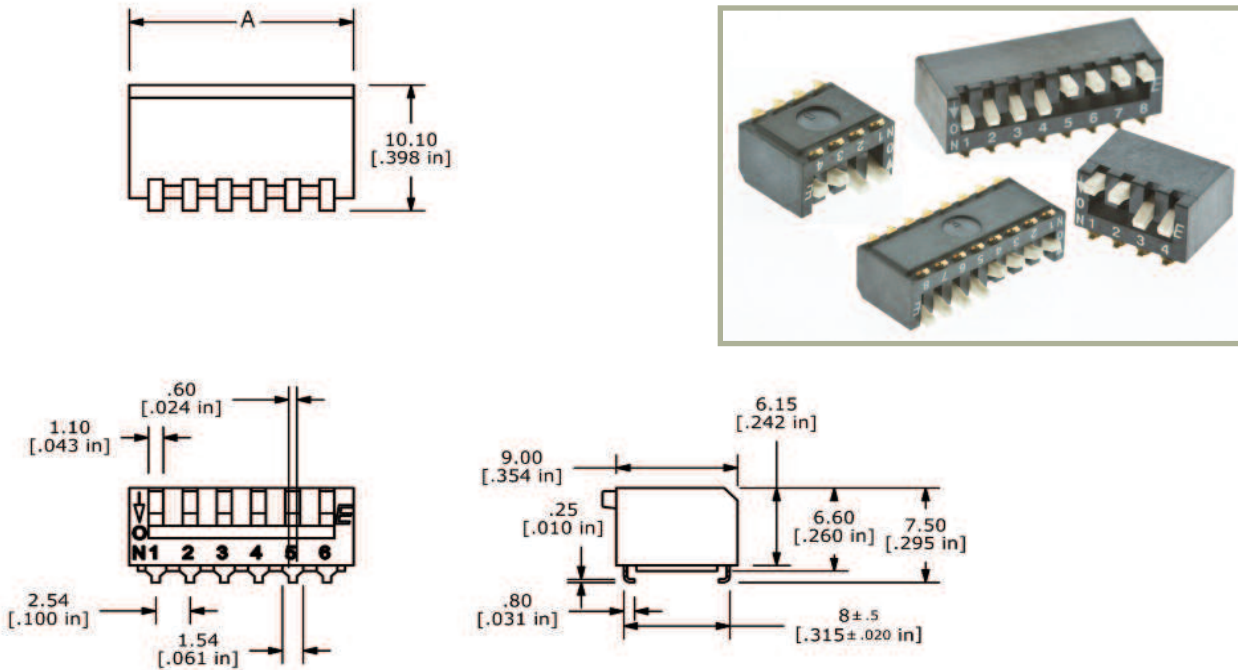

GULL WING TERMINATION - "G"

