



Chipsmall Limited consists of a professional team with an average of over 10 year of expertise in the distribution of electronic components. Based in Hongkong, we have already established firm and mutual-benefit business relationships with customers from,Europe,America and south Asia,supplying obsolete and hard-to-find components to meet their specific needs.

With the principle of “Quality Parts,Customers Priority,Honest Operation,and Considerate Service”,our business mainly focus on the distribution of electronic components. Line cards we deal with include Microchip,ALPS,ROHM,Xilinx,Pulse,ON,Everlight and Freescale. Main products comprise IC,Modules,Potentiometer,IC Socket,Relay,Connector.Our parts cover such applications as commercial,industrial, and automotives areas.

We are looking forward to setting up business relationship with you and hope to provide you with the best service and solution. Let us make a better world for our industry!



Contact us

Tel: +86-755-8981 8866 Fax: +86-755-8427 6832

Email & Skype: info@chipsmall.com Web: www.chipsmall.com

Address: A1208, Overseas Decoration Building, #122 Zhenhua RD., Futian, Shenzhen, China



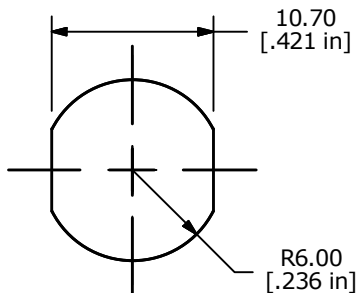

RECOMMENDED PANEL CUTOUT

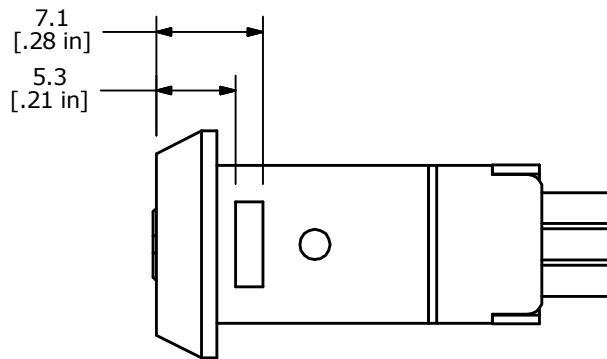

SHOWN WITH PROVIDED HEX NUT

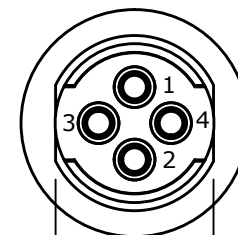
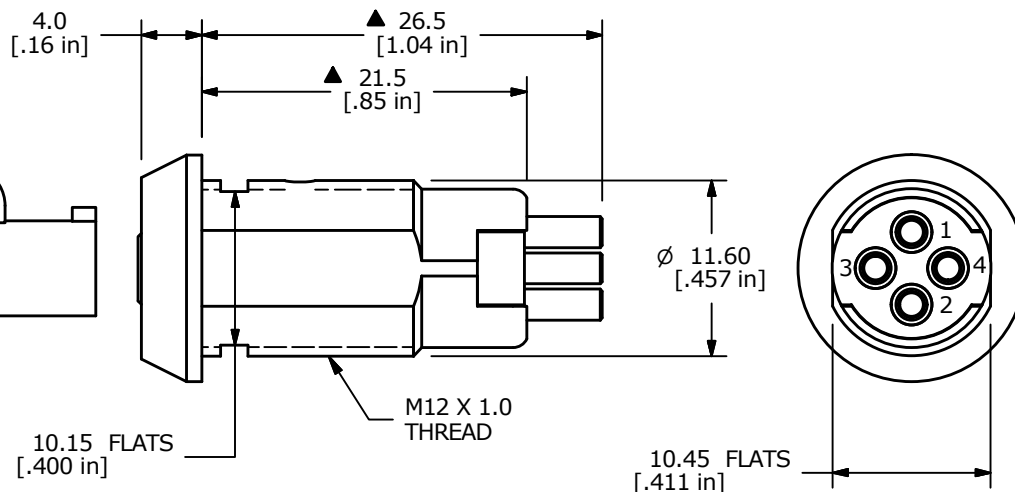
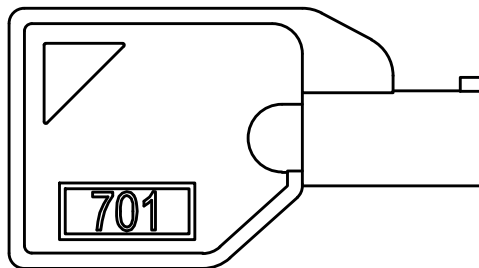
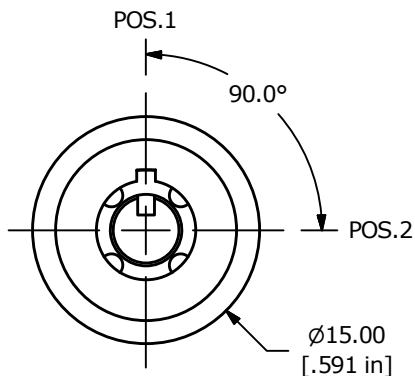

NOTE:

1. DIMENSIONS IN MM [INCH]
2. GENERAL TOLERANCE: X.X = ± 0.4
X.XX = ± 0.25
3. TERMINAL NUMBERS FOR REF ONLY
4. CONTACT RATINGS: 1A @ 125VAC, 0.5A @ 250VAC
5. CONTACT RESISTANCE: 10mΩ MAX.
6. INSULATION RESISTANCE: 200MΩ MIN.
7. DIELECTRIC STRENGTH: 1,000VAC FOR 1 MINUTE
8. ▲ DENOTES CRITICAL PARAMETER
9. MATERIALS:
HOUSING: ZINC ALLOY CAST
CYLINDER: ZINC ALLOY W/ CHROME PLATING
TERMINAL AND CONTACTS: SILVER PLATED
KEY: TUBULAR - ZINC ALLOY WITH CHROME PLATING
10. PANEL THICKNESS: 10MM MAX.
- ▲ 11. KEYCODE: 701 (QTY. 2)

LEGEND

- ⊙ = KEY PULL POSSIBLE IN THESE POSITIONS
- = DETENT POSITIONS

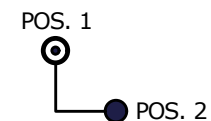

SWITCH FUNCTION	
CONNECTED TERMINAL #	
POS.1	POS.2
ON	ON
1-2	3-4

▲ CIRCUIT: SPDT (90° INDEXING) CONTACT CONFIGURATION

C	22207	UPDATED AND REDRAWN IN INVENTOR	3/16/16	MJR
B	14336	CORRECT SIDE VIEW	9/22/04	AR
A	11743	RELEASED FOR PRODUCTION	10/15/01	CJB
REV	PCR NO	DESCRIPTION	DATE	BY



TITLE KO103C-701

SCALE	DATE	DR	DWG	REV
2:1	10/15/2001	AS	K100204	C

THE INFORMATION CONTAINED IN THIS DOCUMENT IS PROPRIETARY TO E-SWITCH AND IS NOT TO BE COPIED OR TRANSFERRED