



Chipsmall Limited consists of a professional team with an average of over 10 year of expertise in the distribution of electronic components. Based in Hongkong, we have already established firm and mutual-benefit business relationships with customers from,Europe,America and south Asia,supplying obsolete and hard-to-find components to meet their specific needs.

With the principle of "Quality Parts,Customers Priority,Honest Operation,and Considerate Service",our business mainly focus on the distribution of electronic components. Line cards we deal with include Microchip,ALPS,ROHM,Xilinx,Pulse,ON,Everlight and Freescale. Main products comprise IC,Modules,Potentiometer,IC Socket,Relay,Connector.Our parts cover such applications as commercial,industrial, and automotives areas.

We are looking forward to setting up business relationship with you and hope to provide you with the best service and solution. Let us make a better world for our industry!



Contact us

Tel: +86-755-8981 8866 Fax: +86-755-8427 6832

Email & Skype: info@chipsmall.com Web: www.chipsmall.com

Address: A1208, Overseas Decoration Building, #122 Zhenhua RD., Futian, Shenzhen, China



KSC2786

KSC2786

TV PIF Amplifier, FM Tuner RF Amplifier, Mixer, Oscillator

- High Current Gain Bandwidth Product : $f_T=600\text{MHz}$ (TYP)
- High Power Gain : $G_{PE}=22\text{dB}$ at $f=100\text{MHz}$

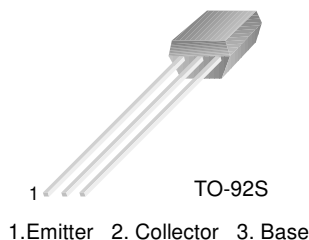

NPN Epitaxial Silicon Transistor

Absolute Maximum Ratings $T_a=25^\circ\text{C}$ unless otherwise noted

Symbol	Parameter	Value	Units
V_{CBO}	Collector-Base Voltage	30	V
V_{CEO}	Collector-Emitter Voltage	20	V
V_{EBO}	Emitter-Base Voltage	4	V
I_C	Collector Current	20	mA
P_C	Collector Power Dissipation	250	mW
T_J	Junction Temperature	150	$^\circ\text{C}$
T_{STG}	Storage Temperature	-55 ~ 150	$^\circ\text{C}$

Electrical Characteristics $T_a=25^\circ\text{C}$ unless otherwise noted

Symbol	Parameter	Test Condition	Min.	Typ.	Max.	Units
BV_{CBO}	Collector-Base Breakdown Voltage	$I_C=10\mu\text{A}, I_E=0$	30			V
BV_{CEO}	Collector-Emitter Breakdown Voltage	$I_C=5\text{mA}, I_B=0$	20			V
BV_{EBO}	Emitter-Base Breakdown Voltage	$I_E=10\mu\text{A}, I_C=0$	4			V
I_{CBO}	Collector Cut-off Current	$V_{CB}=30\text{V}, I_E=0$			0.1	μA
I_{EBO}	Emitter Cut-off Current	$V_{EB}=4\text{V}, I_C=0$			0.1	μA
h_{FE}	DC Current Gain	$V_{CE}=6\text{V}, I_C=1\text{mA}$	40		240	
$V_{BE}(\text{on})$	Base-Emitter On Voltage	$V_{CE}=6\text{V}, I_C=1\text{mA}$		0.72		V
$V_{CE}(\text{sat})$	Collector-Emitter Saturation Voltage	$I_C=10\text{mA}, I_B=1\text{mA}$		0.1	0.3	V
f_T	Current Gain Bandwidth Product	$V_{CE}=6\text{V}, I_C=1\text{mA}$	400	600		MHz
C_{ob}	Output Capacitance	$V_{CB}=6\text{V}, I_E=0, f=1\text{MHz}$		1.2		pF
$C_{c-rbb'}$	Collector-Base Time Constant	$V_{CE}=6\text{V}, I_C=1\text{mA}$ $f=31.9\text{MHz}$		12	15	ps
NF	Noise Figure	$V_{CE}=6\text{V}, I_C=1\text{mA}$ $R_S=50\Omega, f=100\text{MHz}$		3.0	5.0	dB
G_{PE}	Power Gain	$V_{CE}=6\text{V}, I_C=1\text{mA}$ $f=100\text{MHz}$	18	22		dB

h_{FE} Classification

Classification	R	O	Y
h_{FE}	40 ~ 80	70 ~ 140	120 ~ 240

Typical Characteristics

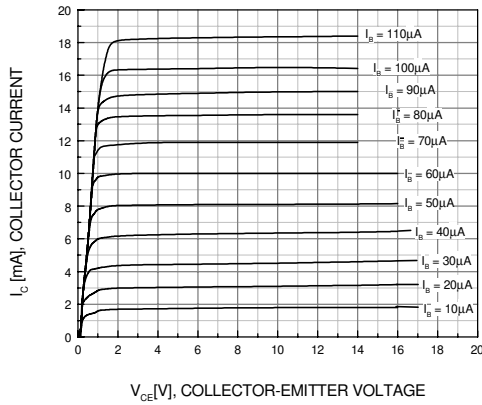

Figure 1. Static Characteristics

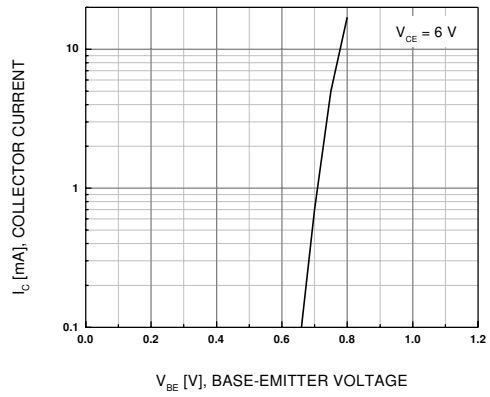

Figure 2. Base-Emitter On Voltage

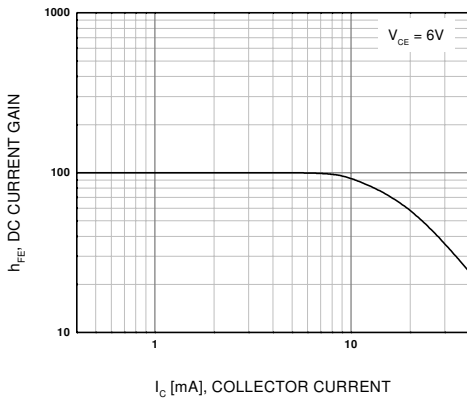

Figure 3. DC Current Gain

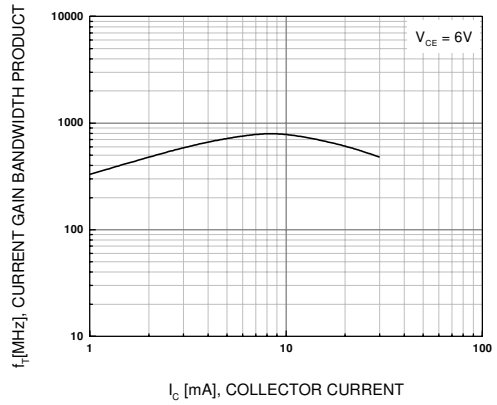

Figure 4. $f_T - I_C$

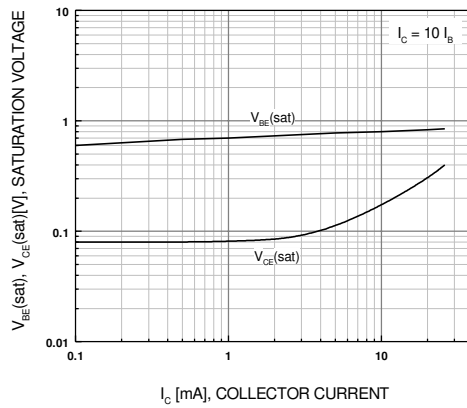

Figure 5. Saturation Voltage

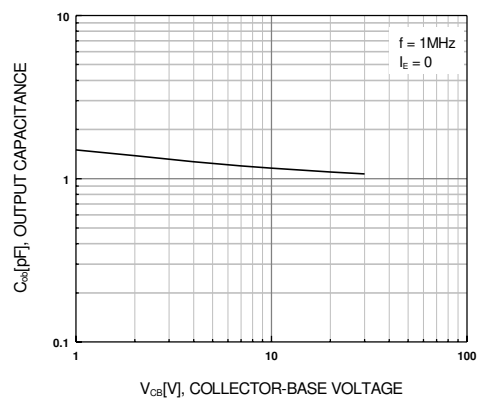

Figure 6. Output Capacitance

Typical Characteristics (Continued)

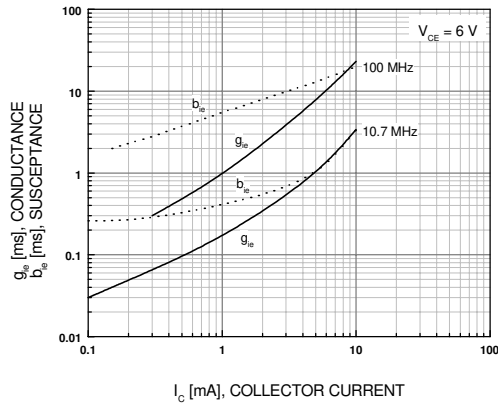

Figure 7. yie - f

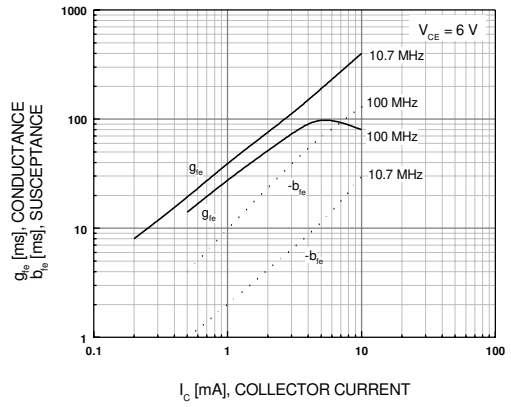

Figure 8. yfe - f

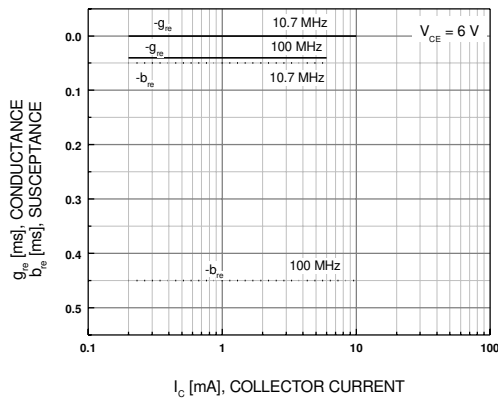

Figure 9. yre - f

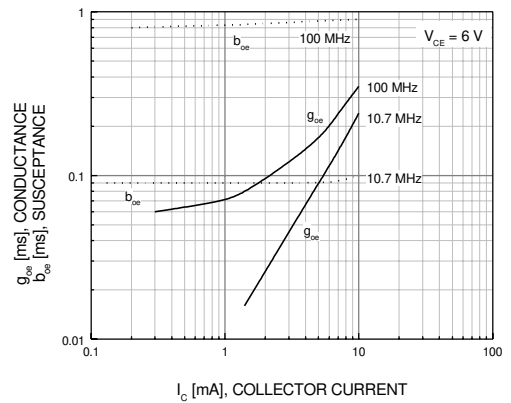

Figure 10. yoe - f

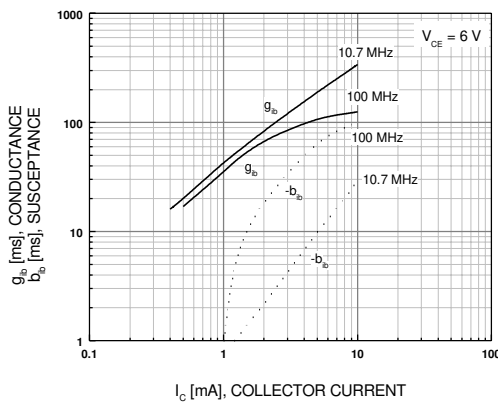

Figure 11. yib - f

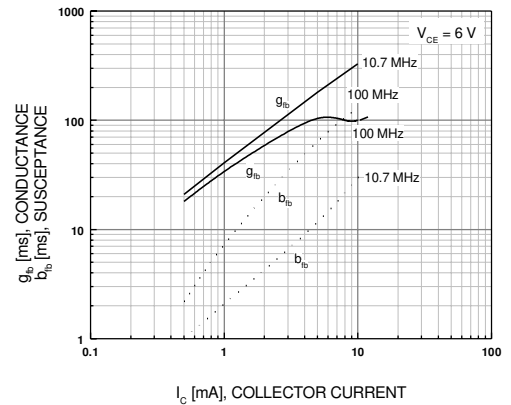

Figure 12. yfb - f

Typical Characteristics (Continued)

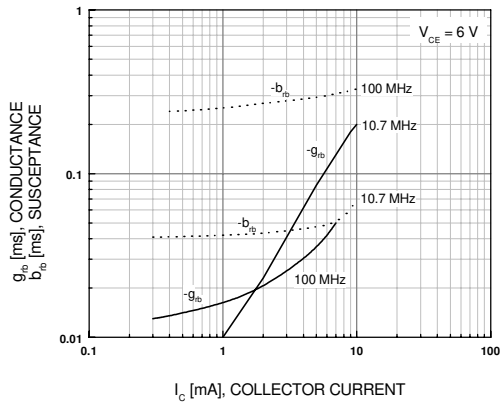

Figure 13. yrb - f

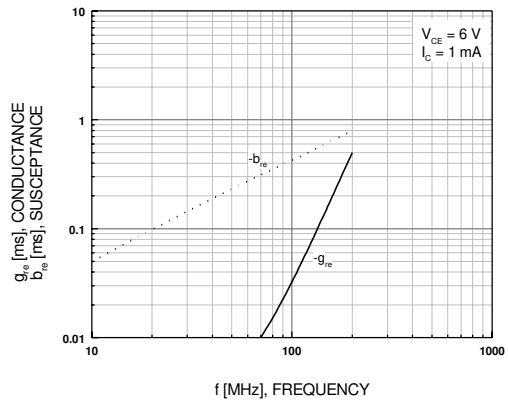

Figure 14. yre - f

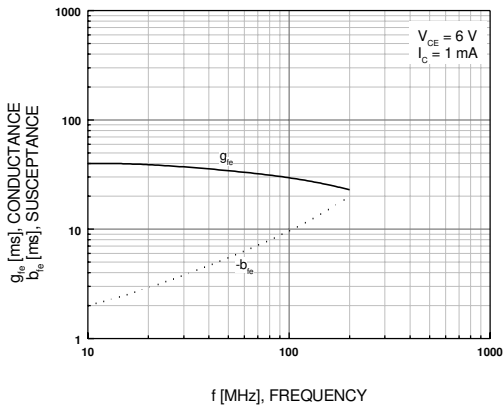

Figure 15. yfe - f

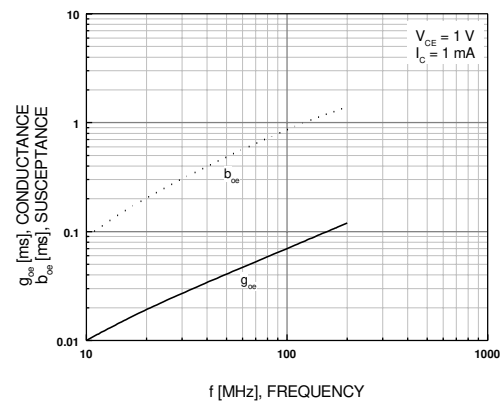

Figure 16. yoe - f

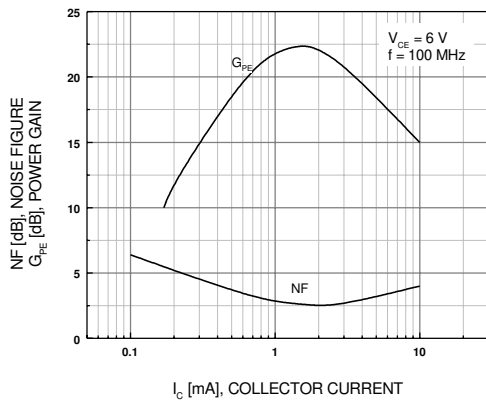

Figure 17. Power Gain & NF

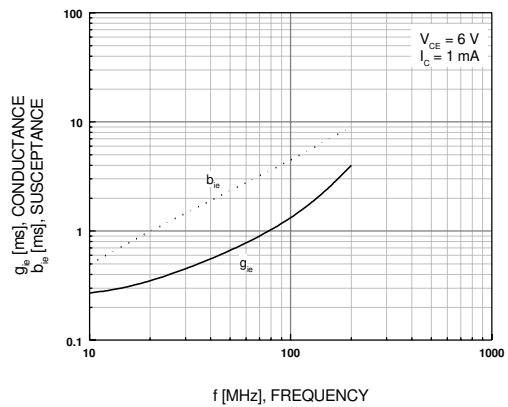
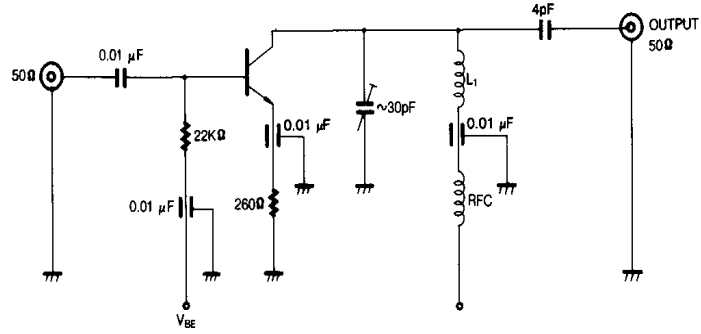

Figure 18. yie - f

Typical Characteristics (Continued)

KSC2786

100MHz G_{pe} , NF TEST CIRCUIT



Package Dimensions

TO-92S

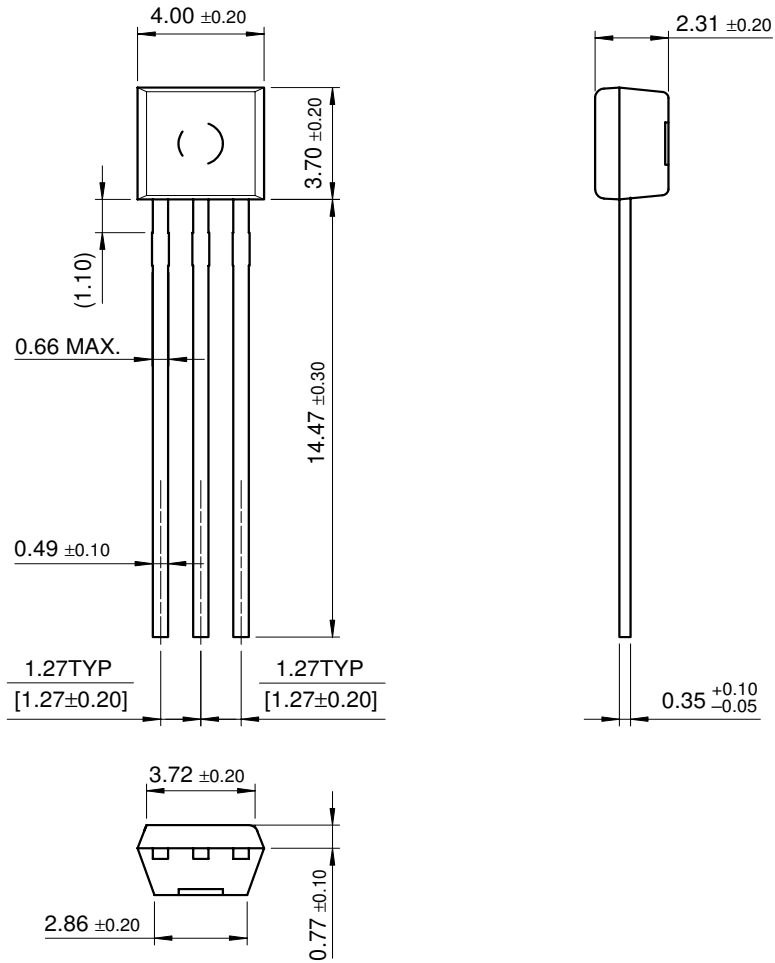

Dimensions in Millimeters

TRADEMARKS

The following are registered and unregistered trademarks Fairchild Semiconductor owns or is authorized to use and is not intended to be an exhaustive list of all such trademarks.

ACE ^x ™	FACT™	ImpliedDisconnect™	PACMAN™	SPM™
ActiveArray™	FACT Quiet series™	ISOPLANAR™	POP™	Stealth™
Bottomless™	FAST®	LittleFET™	Power247™	SuperSOT™-3
CoolFET™	FAST _r ™	MicroFET™	PowerTrench®	SuperSOT™-6
CROSSVOLT™	FRFET™	MicroPak™	QFET™	SuperSOT™-8
DOME™	GlobalOptoisolator™	MICROWIRE™	QS™	SyncFET™
EcoSPARK™	GTO™	MSX™	QT Optoelectronics™	TinyLogic™
E ² CMOS™	HiSeC™	MSXPro™	Quiet Series™	TruTranslation™
EnSigna™	I ² C™	OCX™	RapidConfigure™	UHC™
Across the board. Around the world.™		OCXPro™	RapidConnect™	UltraFET®
The Power Franchise™		OPTOLOGIC®	SILENT SWITCHER®	VCX™
Programmable Active Droop™		OPTOPLANAR™	SMART START™	

DISCLAIMER

FAIRCHILD SEMICONDUCTOR RESERVES THE RIGHT TO MAKE CHANGES WITHOUT FURTHER NOTICE TO ANY PRODUCTS HEREIN TO IMPROVE RELIABILITY, FUNCTION OR DESIGN. FAIRCHILD DOES NOT ASSUME ANY LIABILITY ARISING OUT OF THE APPLICATION OR USE OF ANY PRODUCT OR CIRCUIT DESCRIBED HEREIN; NEITHER DOES IT CONVEY ANY LICENSE UNDER ITS PATENT RIGHTS, NOR THE RIGHTS OF OTHERS.

LIFE SUPPORT POLICY

FAIRCHILD'S PRODUCTS ARE NOT AUTHORIZED FOR USE AS CRITICAL COMPONENTS IN LIFE SUPPORT DEVICES OR SYSTEMS WITHOUT THE EXPRESS WRITTEN APPROVAL OF FAIRCHILD SEMICONDUCTOR CORPORATION.

As used herein:

1. Life support devices or systems are devices or systems which, (a) are intended for surgical implant into the body, or (b) support or sustain life, or (c) whose failure to perform when properly used in accordance with instructions for use provided in the labeling, can be reasonably expected to result in significant injury to the user.
2. A critical component is any component of a life support device or system whose failure to perform can be reasonably expected to cause the failure of the life support device or system, or to affect its safety or effectiveness.

PRODUCT STATUS DEFINITIONS

Definition of Terms

Datasheet Identification	Product Status	Definition
Advance Information	Formative or In Design	This datasheet contains the design specifications for product development. Specifications may change in any manner without notice.
Preliminary	First Production	This datasheet contains preliminary data, and supplementary data will be published at a later date. Fairchild Semiconductor reserves the right to make changes at any time without notice in order to improve design.
No Identification Needed	Full Production	This datasheet contains final specifications. Fairchild Semiconductor reserves the right to make changes at any time without notice in order to improve design.
Obsolete	Not In Production	This datasheet contains specifications on a product that has been discontinued by Fairchild semiconductor. The datasheet is printed for reference information only.