



Chipsmall Limited consists of a professional team with an average of over 10 year of expertise in the distribution of electronic components. Based in Hongkong, we have already established firm and mutual-benefit business relationships with customers from,Europe,America and south Asia,supplying obsolete and hard-to-find components to meet their specific needs.

With the principle of “Quality Parts,Customers Priority,Honest Operation,and Considerate Service”,our business mainly focus on the distribution of electronic components. Line cards we deal with include Microchip,ALPS,ROHM,Xilinx,Pulse,ON,Everlight and Freescale. Main products comprise IC,Modules,Potentiometer,IC Socket,Relay,Connector.Our parts cover such applications as commercial,industrial, and automotives areas.

We are looking forward to setting up business relationship with you and hope to provide you with the best service and solution. Let us make a better world for our industry!



Contact us

Tel: +86-755-8981 8866 Fax: +86-755-8427 6832

Email & Skype: info@chipsmall.com Web: www.chipsmall.com

Address: A1208, Overseas Decoration Building, #122 Zhenhua RD., Futian, Shenzhen, China





Is Now Part of



ON Semiconductor®

To learn more about ON Semiconductor, please visit our website at
www.onsemi.com

ON Semiconductor and the ON Semiconductor logo are trademarks of Semiconductor Components Industries, LLC dba ON Semiconductor or its subsidiaries in the United States and/or other countries. ON Semiconductor owns the rights to a number of patents, trademarks, copyrights, trade secrets, and other intellectual property. A listing of ON Semiconductor's product/patent coverage may be accessed at www.onsemi.com/site/pdf/Patent-Marking.pdf. ON Semiconductor reserves the right to make changes without further notice to any products herein. ON Semiconductor makes no warranty, representation or guarantee regarding the suitability of its products for any particular purpose, nor does ON Semiconductor assume any liability arising out of the application or use of any product or circuit, and specifically disclaims any and all liability, including without limitation special, consequential or incidental damages. Buyer is responsible for its products and applications using ON Semiconductor products, including compliance with all laws, regulations and safety requirements or standards, regardless of any support or applications information provided by ON Semiconductor. "Typical" parameters which may be provided in ON Semiconductor data sheets and/or specifications can and do vary in different applications and actual performance may vary over time. All operating parameters, including "Typicals" must be validated for each customer application by customer's technical experts. ON Semiconductor does not convey any license under its patent rights nor the rights of others. ON Semiconductor products are not designed, intended, or authorized for use as a critical component in life support systems or any FDA Class 3 medical devices or medical devices with a same or similar classification in a foreign jurisdiction or any devices intended for implantation in the human body. Should Buyer purchase or use ON Semiconductor products for any such unintended or unauthorized application, Buyer shall indemnify and hold ON Semiconductor and its officers, employees, subsidiaries, affiliates, and distributors harmless against all claims, costs, damages, and expenses, and reasonable attorney fees arising out of, directly or indirectly, any claim of personal injury or death associated with such unintended or unauthorized use, even if such claim alleges that ON Semiconductor was negligent regarding the design or manufacture of the part. ON Semiconductor is an Equal Opportunity/Affirmative Action Employer. This literature is subject to all applicable copyright laws and is not for resale in any manner.

KSE800/801/802/803

Monolithic Construction With Built-in Base-Emitter Resistors

- High DC Current Gain : $h_{FE} = 750$ (Min.) @ $I_C = 1.5$ and $2.0A$ DC
- Complement to KSE700/701/702/703

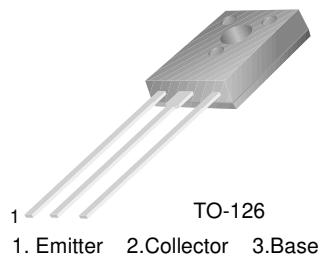

NPN Epitaxial Silicon Darlington Transistor

Absolute Maximum Ratings $T_C = 25^\circ C$ unless otherwise noted

Symbol	Parameter	Value	Units
V_{CBO}	Collector- Base Voltage	: KSE800/801	60 V
		: KSE802/803	80 V
V_{CEO}	Collector-Emitter Voltage	: KSE800/801	60 V
		: KSE802/803	80 V
V_{EBO}	Emitter-Base Voltage	5	V
I_C	Collector Current	4	A
I_B	Base Current	0.1	A
P_C	Collector Dissipation ($T_C = 25^\circ C$)	40	W
T_J	Junction Temperature	150	$^\circ C$
T_{STG}	Storage Temperature	- 55 ~ 150	$^\circ C$

Equivalent Circuit

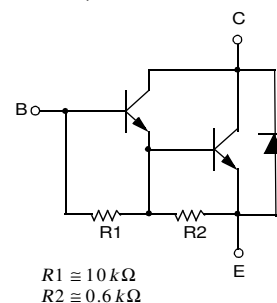

Electrical Characteristics $T_C = 25^\circ C$ unless otherwise noted

Symbol	Parameter	Test Condition	Min.	Max.	Units
BV_{CEO}	Collector-Emitter Breakdown Voltage	: KSE800/801	$I_C = 50mA, I_B = 0$	60	V
		: KSE802/803		80	
I_{CEO}	Collector Cut-off Current	: KSE800/801	$V_{CE} = 60V, I_B = 0$	100	μA
		: KSE802/803	$V_{CE} = 80V, I_B = 0$	100	μA
I_{CBO}	Collector Cut-off Current	$V_{CB} = \text{Rated } BV_{CEO}, I_E = 0$	$V_{CB} = \text{Rated } BV_{CEO}, I_E = 0$ $T_C = 100^\circ C$	100	μA
		$V_{CB} = \text{Rated } BV_{CEO}, I_E = 0$		500	μA
I_{EBO}	Emitter Cut-off Current	$V_{BE} = 5V, I_C = 0$		2	mA
h_{FE}	DC Current Gain	: KSE800/802	$V_{CE} = 3V, I_C = 1.5A$	750	
		: KSE801/803	$V_{CE} = 3V, I_C = 2A$	750	
		: ALL DEVICES	$V_{CE} = 3V, I_C = 4A$	100	
$V_{CE(sat)}$	Collector-Emitter Saturation Voltage	: KSE800/802	$I_C = 1.5A, I_B = 30mA$	2.5	V
		: KSE801/803	$I_C = 2A, I_B = 40mA$	2.8	V
		: ALL DEVICES	$I_C = 4A, I_B = 40mA$	3	V
$V_{BE(on)}$	Base-Emitter ON Voltage	: KSE800/802	$V_{CE} = 3V, I_C = 1.5A$	2.5	V
		: KSE801/803	$V_{CE} = 3V, I_C = 2A$	2.5	V
		: ALL DEVICES	$V_{CE} = 3V, I_C = 4A$	3	V

Typical Characteristics

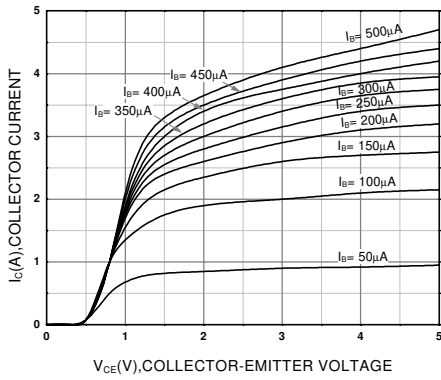

Figure 1. Static Characteristic

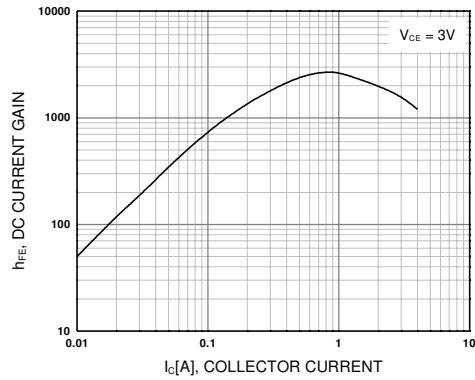

Figure 2. DC current Gain

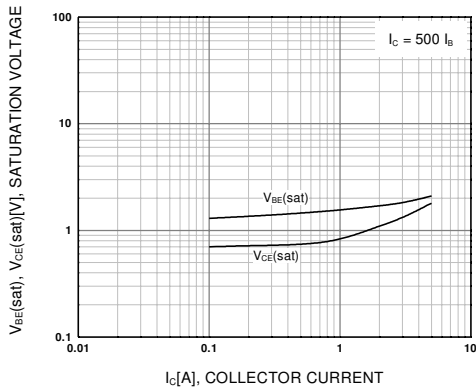

Figure 3. Collector-Emitter Saturation Voltage
Base-Emitter Saturation Voltage

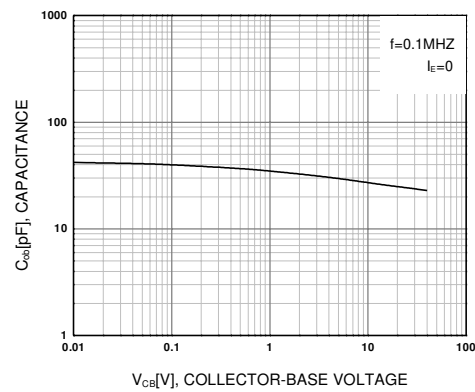

Figure 4. Collector Output Capacitance

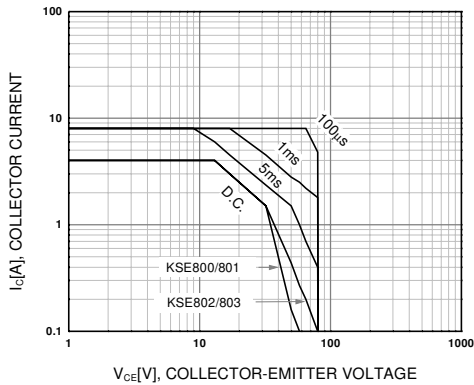

Figure 5. Safe Operating Area

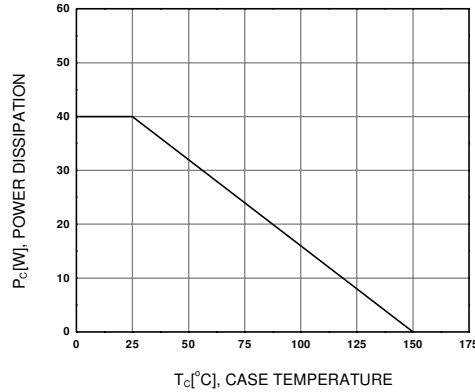
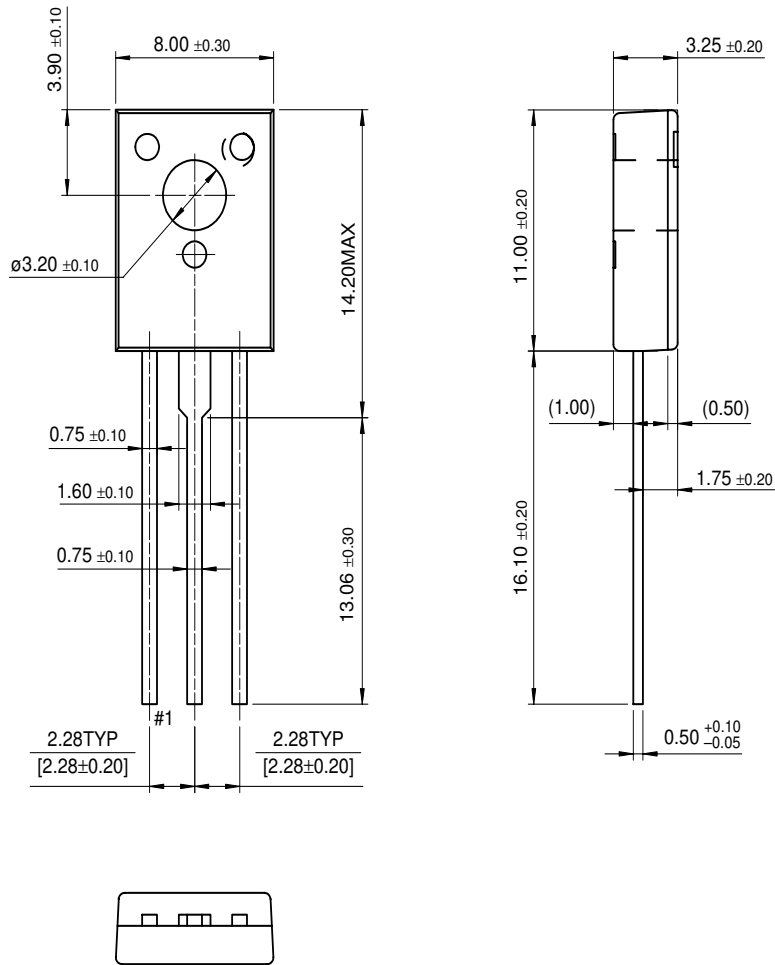

Figure 6. Power Derating

Package Dimensions

TO-126



KSE800/801/802/803

Dimensions in Millimeters

TRADEMARKS

The following are registered and unregistered trademarks Fairchild Semiconductor owns or is authorized to use and is not intended to be an exhaustive list of all such trademarks.

ACE _x [™]	FAST [®]	OPTOPLANAR [™]	STAR*POWER [™]
Bottomless [™]	FAST _r [™]	PACMAN [™]	Stealth [™]
CoolFET [™]	FRFET [™]	POP [™]	SuperSOT [™] -3
CROSSVOLT [™]	GlobalOptoisolator [™]	Power247 [™]	SuperSOT [™] -6
DenseTrench [™]	GTO [™]	PowerTrench [®]	SuperSOT [™] -8
DO _M E [™]	HiSeC [™]	QFET [™]	SyncFET [™]
EcoSPARK [™]	ISOPLANAR [™]	QS [™]	TruTranslation [™]
E ² CMOS [™]	LittleFET [™]	QT Optoelectronics [™]	TinyLogic [™]
EnSigna [™]	MicroFET [™]	Quiet Series [™]	UHC [™]
FACT [™]	MICROWIRE [™]	SLIENT SWITCHER [®]	UltraFET [®]
FACT Quiet Series [™]	OPTOLOGIC [™]	SMART START [™]	VCX [™]

STAR*POWER is used under license

DISCLAIMER

FAIRCHILD SEMICONDUCTOR RESERVES THE RIGHT TO MAKE CHANGES WITHOUT FURTHER NOTICE TO ANY PRODUCTS HEREIN TO IMPROVE RELIABILITY, FUNCTION OR DESIGN. FAIRCHILD DOES NOT ASSUME ANY LIABILITY ARISING OUT OF THE APPLICATION OR USE OF ANY PRODUCT OR CIRCUIT DESCRIBED HEREIN; NEITHER DOES IT CONVEY ANY LICENSE UNDER ITS PATENT RIGHTS, NOR THE RIGHTS OF OTHERS.

LIFE SUPPORT POLICY

FAIRCHILD'S PRODUCTS ARE NOT AUTHORIZED FOR USE AS CRITICAL COMPONENTS IN LIFE SUPPORT DEVICES OR SYSTEMS WITHOUT THE EXPRESS WRITTEN APPROVAL OF FAIRCHILD SEMICONDUCTOR CORPORATION.

As used herein:

1. Life support devices or systems are devices or systems which, (a) are intended for surgical implant into the body, or (b) support or sustain life, or (c) whose failure to perform when properly used in accordance with instructions for use provided in the labeling, can be reasonably expected to result in significant injury to the user.
2. A critical component is any component of a life support device or system whose failure to perform can be reasonably expected to cause the failure of the life support device or system, or to affect its safety or effectiveness.

PRODUCT STATUS DEFINITIONS

Definition of Terms

Datasheet Identification	Product Status	Definition
Advance Information	Formative or In Design	This datasheet contains the design specifications for product development. Specifications may change in any manner without notice.
Preliminary	First Production	This datasheet contains preliminary data, and supplementary data will be published at a later date. Fairchild Semiconductor reserves the right to make changes at any time without notice in order to improve design.
No Identification Needed	Full Production	This datasheet contains final specifications. Fairchild Semiconductor reserves the right to make changes at any time without notice in order to improve design.
Obsolete	Not In Production	This datasheet contains specifications on a product that has been discontinued by Fairchild semiconductor. The datasheet is printed for reference information only.

ON Semiconductor and  are trademarks of Semiconductor Components Industries, LLC dba ON Semiconductor or its subsidiaries in the United States and/or other countries. ON Semiconductor owns the rights to a number of patents, trademarks, copyrights, trade secrets, and other intellectual property. A listing of ON Semiconductor's product/patent coverage may be accessed at www.onsemi.com/site/pdf/Patent-Marking.pdf. ON Semiconductor reserves the right to make changes without further notice to any products herein. ON Semiconductor makes no warranty, representation or guarantee regarding the suitability of its products for any particular purpose, nor does ON Semiconductor assume any liability arising out of the application or use of any product or circuit, and specifically disclaims any and all liability, including without limitation special, consequential or incidental damages. Buyer is responsible for its products and applications using ON Semiconductor products, including compliance with all laws, regulations and safety requirements or standards, regardless of any support or applications information provided by ON Semiconductor. "Typical" parameters which may be provided in ON Semiconductor data sheets and/or specifications can and do vary in different applications and actual performance may vary over time. All operating parameters, including "Typicals" must be validated for each customer application by customer's technical experts. ON Semiconductor does not convey any license under its patent rights nor the rights of others. ON Semiconductor products are not designed, intended, or authorized for use as a critical component in life support systems or any FDA Class 3 medical devices or medical devices with a same or similar classification in a foreign jurisdiction or any devices intended for implantation in the human body. Should Buyer purchase or use ON Semiconductor products for any such unintended or unauthorized application, Buyer shall indemnify and hold ON Semiconductor and its officers, employees, subsidiaries, affiliates, and distributors harmless against all claims, costs, damages, and expenses, and reasonable attorney fees arising out of, directly or indirectly, any claim of personal injury or death associated with such unintended or unauthorized use, even if such claim alleges that ON Semiconductor was negligent regarding the design or manufacture of the part. ON Semiconductor is an Equal Opportunity/Affirmative Action Employer. This literature is subject to all applicable copyright laws and is not for resale in any manner.

PUBLICATION ORDERING INFORMATION

LITERATURE FULFILLMENT:

Literature Distribution Center for ON Semiconductor
19521 E. 32nd Pkwy, Aurora, Colorado 80011 USA
Phone: 303-675-2175 or 800-344-3860 Toll Free USA/Canada
Fax: 303-675-2176 or 800-344-3867 Toll Free USA/Canada
Email: orderlit@onsemi.com

N. American Technical Support: 800-282-9855 Toll Free
USA/Canada
Europe, Middle East and Africa Technical Support:
Phone: 421 33 790 2910
Japan Customer Focus Center
Phone: 81-3-5817-1050

ON Semiconductor Website: www.onsemi.com
Order Literature: <http://www.onsemi.com/orderlit>
For additional information, please contact your local
Sales Representative