



Chipsmall Limited consists of a professional team with an average of over 10 year of expertise in the distribution of electronic components. Based in Hongkong, we have already established firm and mutual-benefit business relationships with customers from,Europe,America and south Asia,supplying obsolete and hard-to-find components to meet their specific needs.

With the principle of "Quality Parts,Customers Priority,Honest Operation,and Considerate Service",our business mainly focus on the distribution of electronic components. Line cards we deal with include Microchip,ALPS,ROHM,Xilinx,Pulse,ON,Everlight and Freescale. Main products comprise IC,Modules,Potentiometer,IC Socket,Relay,Connector.Our parts cover such applications as commercial,industrial, and automotives areas.

We are looking forward to setting up business relationship with you and hope to provide you with the best service and solution. Let us make a better world for our industry!



Contact us

Tel: +86-755-8981 8866 Fax: +86-755-8427 6832

Email & Skype: info@chipsmall.com Web: www.chipsmall.com

Address: A1208, Overseas Decoration Building, #122 Zhenhua RD., Futian, Shenzhen, China





KT5G-2P1112

KT5

CONTRAST SENSORS

SICK
Sensor Intelligence.



Ordering information

Type	Part no.
KT5G-2P1112	1016628

Other models and accessories → www.sick.com/KT5



Detailed technical data

Features

Dimensions (W x H x D)	30.4 mm x 53 mm x 80 mm
Sensing distance	10 mm ¹⁾
Sensing distance tolerance	± 3 mm
Housing design (light emission)	Rectangular
Light source	LED, green ²⁾
Wave length	520 nm
Light emission	Long and short side of housing, exchangeable
Light spot size	1.2 mm x 4.2 mm
Light spot direction	Vertical ³⁾
Adjustment	Teach-in button
Teach-in mode	1-point-teach-in

¹⁾ From front edge of lens.

²⁾ Average service life: 100,000 h at T_J = +25 °C.

³⁾ In relation to long side of housing.

Mechanics/electronics

Supply voltage	10 V DC ... 30 V DC ¹⁾
Ripple	≤ 5 V _{pp} ²⁾
Power consumption	< 80 mA ³⁾
Switching frequency	10 kHz ⁴⁾

¹⁾ Limit values when operated in short-circuit protected network: max. 8 A.

²⁾ May not exceed or fall below U_v tolerances.

³⁾ Without load.

⁴⁾ With light/dark ratio 1:1.

⁵⁾ Signal transit time with resistive load.

⁶⁾ Short-circuit protected.

⁷⁾ Reference voltage DC 50 V.

Response time	50 μ s ⁵⁾
Switching output	PNP
Switching output (voltage)	PNP: HIGH = $V_S - \leq 2$ V / LOW approx. 0 V
Output current I_{max}.	100 mA ⁶⁾
Input, teach-in (ET)	PNP Teach: U = 10 V ... < U_V Run: U < 2 V
Input, fine/coarse (F/C)	PNP: fine: U = 0 V Coarse: U > 10 V ... < U_V
Retention time (ET)	25 ms, non-volatile memory
Connection type	Male connector M12, 5-pin
Protection class	II ⁷⁾
Circuit protection	U_V connections, reverse polarity protected Output Q short-circuit protected Interference pulse suppression
Weight	400 g
Housing material	Zinc diecast

1) Limit values when operated in short-circuit protected network: max. 8 A.

2) May not exceed or fall below U_V tolerances.

3) Without load.

4) With light/dark ratio 1:1.

5) Signal transit time with resistive load.

6) Short-circuit protected.

7) Reference voltage DC 50 V.

Ambient data

Ambient operating temperature	-10 °C ... +55 °C
Ambient storage temperature	-25 °C ... +75 °C
Shock load	According to IEC 60068
UL File No.	NRKH.E181493 & NRKH7.E181493

Classifications

ECl@ss 5.0	27270906
ECl@ss 5.1.4	27270906
ECl@ss 6.0	27270906
ECl@ss 6.2	27270906
ECl@ss 7.0	27270906
ECl@ss 8.0	27270906
ECl@ss 8.1	27270906
ECl@ss 9.0	27270906
ETIM 5.0	EC001820
ETIM 6.0	EC001820
UNSPSC 16.0901	39121528

Dimensional drawing (Dimensions in mm (inch))

KT5-2 Teach-in, KT5-2 Display

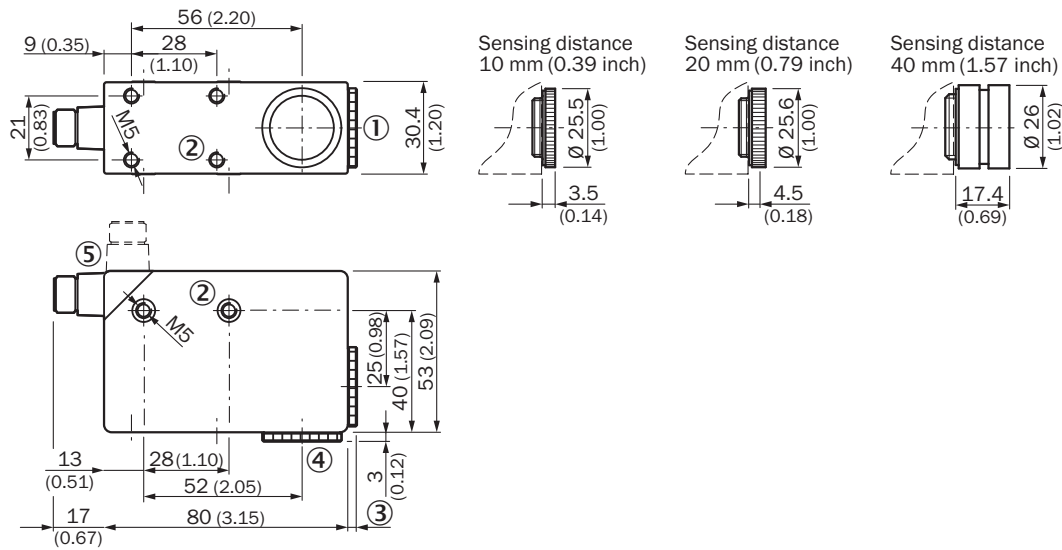

- ① Lens (light transmission), can be exchanged for pos. 4
- ② M5 threaded mounting hole, 5.5 mm deep
- ③ See dimensional drawings of lenses
- ④ Blind screw can be replaced by pos. 1
- ⑤ Connector M12 (rotatable up to 90°)

Adjustments

KT5-2 Teach-in, KT5G-xxx2

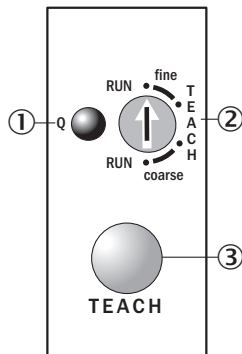

- ① Function signal indicator (yellow)
- ② Pre-selection switch for minimum contrast
- ③ Teach-in button

Connection diagram

Cd-326

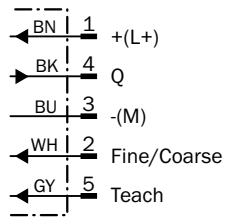

Characteristic curve

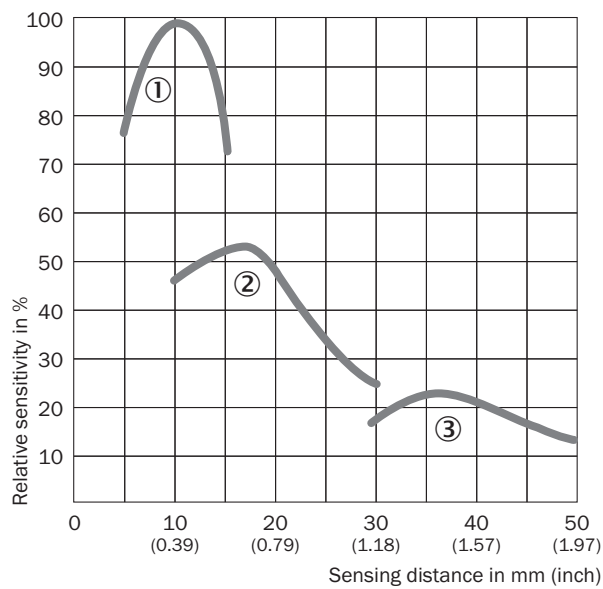

KT5-2 Teach-in, KT5G, KT5W, KT5-2 Display











- ① Sensing distance 10 mm
- ② Sensing distance 20 mm
- ③ Sensing distance 40 mm

Recommended accessories

Other models and accessories → www.sick.com/KT5

	Brief description	Type	Part no.
Universal bar clamp systems			
	Plate G for universal clamp bracket, steel, zinc coated, universal clamp and mounting hardware included	BEF-KHS-G01	2022464
	Plate K for universal clamp bracket, steel, zinc coated, universal clamp and mounting hardware included	BEF-KHS-K01	2022718

	Brief description	Type	Part no.
	Universal clamp bracket for rod mounting, steel, zinc coated, without mounting hardware	BEF-KHS-KH1	2022726
	Mounting bar, straight, 200 mm, steel, steel, zinc coated, without mounting hardware	BEF-MS12G-A	4056054
	Mounting bar, straight, 300 mm, steel, steel, zinc coated, without mounting hardware	BEF-MS12G-B	4056055
	Mounting bar, L-shaped, 150 mm x 150 mm, steel, steel, zinc coated, without mounting hardware	BEF-MS12L-A	4056052
	Mounting bar, L-shaped, 250 x 250 mm, steel, steel, zinc coated, without mounting hardware	BEF-MS12L-B	4056053
Plug connectors and cables			
	Head A: female connector, M12, 5-pin, straight Head B: open cable ends Cable: PVC, unshielded, 2 m	DOL-1205-G02M	6008899
	Head A: female connector, M12, 5-pin, straight Head B: open cable ends Cable: PVC, unshielded, 5 m	DOL-1205-G05M	6009868
	Head A: female connector, M12, 5-pin, straight Head B: open cable ends Cable: PVC, unshielded, 10 m	DOL-1205-G10M	6010544
	Head A: female connector, M12, 5-pin, angled Head B: open cable ends Cable: PVC, unshielded, 2 m	DOL-1205-W02M	6008900
	Head A: female connector, M12, 5-pin, angled Head B: open cable ends Cable: PVC, unshielded, 5 m	DOL-1205-W05M	6009869
	Head A: female connector, M12, 5-pin, angled Head B: open cable ends Cable: PVC, unshielded, 10 m	DOL-1205-W10M	6010542
	Head A: female connector, M12, 5-pin, straight Cable: unshielded	DOS-1205-G	6009719
	Head A: female connector, M12, 5-pin, angled Head B: - Cable: unshielded	DOS-1205-W	6009720
Lenses and accessories			
	Lens, 40 mm sensing distance, M20 x 0.75	OBJ-210	2010945
	Lens, 10 mm sensing distance, M20 x 0.75	OBJ-211	1004936
	Lens, 20 mm sensing distance, M20 x 0.75	OBJ-212	1011506

SICK AT A GLANCE

SICK is one of the leading manufacturers of intelligent sensors and sensor solutions for industrial applications. A unique range of products and services creates the perfect basis for controlling processes securely and efficiently, protecting individuals from accidents and preventing damage to the environment.

We have extensive experience in a wide range of industries and understand their processes and requirements. With intelligent sensors, we can deliver exactly what our customers need. In application centers in Europe, Asia and North America, system solutions are tested and optimized in accordance with customer specifications. All this makes us a reliable supplier and development partner.

Comprehensive services complete our offering: SICK LifeTime Services provide support throughout the machine life cycle and ensure safety and productivity.

For us, that is “Sensor Intelligence.”

WORLDWIDE PRESENCE:

Contacts and other locations www.sick.com