



Chipsmall Limited consists of a professional team with an average of over 10 year of expertise in the distribution of electronic components. Based in Hongkong, we have already established firm and mutual-benefit business relationships with customers from,Europe,America and south Asia,supplying obsolete and hard-to-find components to meet their specific needs.

With the principle of “Quality Parts,Customers Priority,Honest Operation,and Considerate Service”,our business mainly focus on the distribution of electronic components. Line cards we deal with include Microchip,ALPS,ROHM,Xilinx,Pulse,ON,Everlight and Freescale. Main products comprise IC,Modules,Potentiometer,IC Socket,Relay,Connector.Our parts cover such applications as commercial,industrial, and automotives areas.

We are looking forward to setting up business relationship with you and hope to provide you with the best service and solution. Let us make a better world for our industry!



## Contact us

Tel: +86-755-8981 8866 Fax: +86-755-8427 6832

Email & Skype: info@chipsmall.com Web: www.chipsmall.com

Address: A1208, Overseas Decoration Building, #122 Zhenhua RD., Futian, Shenzhen, China





## ± 10g Tri-axis Accelerometer Specifications

PART NUMBER:

KXD94-2802  
Rev. 2  
May-2014

### Product Description

The KXD94-2802 is a Tri-axis, silicon micromachined accelerometer with a full-scale output range of +/-10g (98 m/s/s). The sense element is fabricated using Kionix's proprietary plasma micromachining process technology. Acceleration sensing is based on the principle of a differential capacitance arising from acceleration-induced motion of the sense element, which further utilizes common mode cancellation to decrease errors from process variation, temperature, and environmental stress. The sense element is hermetically sealed at the wafer level by bonding a second silicon lid wafer to the device using a glass frit. A separate ASIC device packaged with the sense element provides signal conditioning and self-test. The accelerometer is delivered in a 5 x 5 x 1.2 mm DFN plastic package operating from a 2.50V - 5.25V DC supply. The three outputs (X, Y, Z) are provided on **analog** output pins. The KXD94 also features an integrated **4-channel multiplexer** (X, Y, Z, and Aux In). The Enable pin must be **high** for normal operation and **low** for power shutdown.



There are 4 factory programmable modes of operation for the KXD94:

- Mode 00** – The three outputs (X, Y, Z) are read through the **digital** SPI interface, which is also used to command Selftest and Standby Mode. The digital I/O pads are powered from a separate power pin, and will interface to 1.8V logic.
- Mode 01** – The three outputs (X, Y, Z) are provided on three **analog** output pins. The KXD94 also features an integrated **3-channel multiplexer** (X, Y, Z). The Enable pin must be **high** for normal operation and **low** for power shutdown.
- Mode 10** – The three outputs (X, Y, Z) are provided on three **analog** output pins. The KXD94 also features an integrated **4-channel multiplexer** (X, Y, Z, Aux In). The Enable pin must be **high** for normal operation and **low** for power shutdown.
- Mode 11** – The three outputs (X, Y, Z) are provided on three **analog** output pins. The KXD94 also features an integrated **4-channel multiplexer** (X, Y, Z, Aux In). The Enable pin must be **low** for normal operation and **high** for power shutdown.

The KXD94-2802 is factory programmed to be in MODE 10.





# ± 10g Tri-axis Accelerometer Specifications

PART NUMBER:

KXD94-2802  
Rev. 2  
May-2014

## Functional Diagram

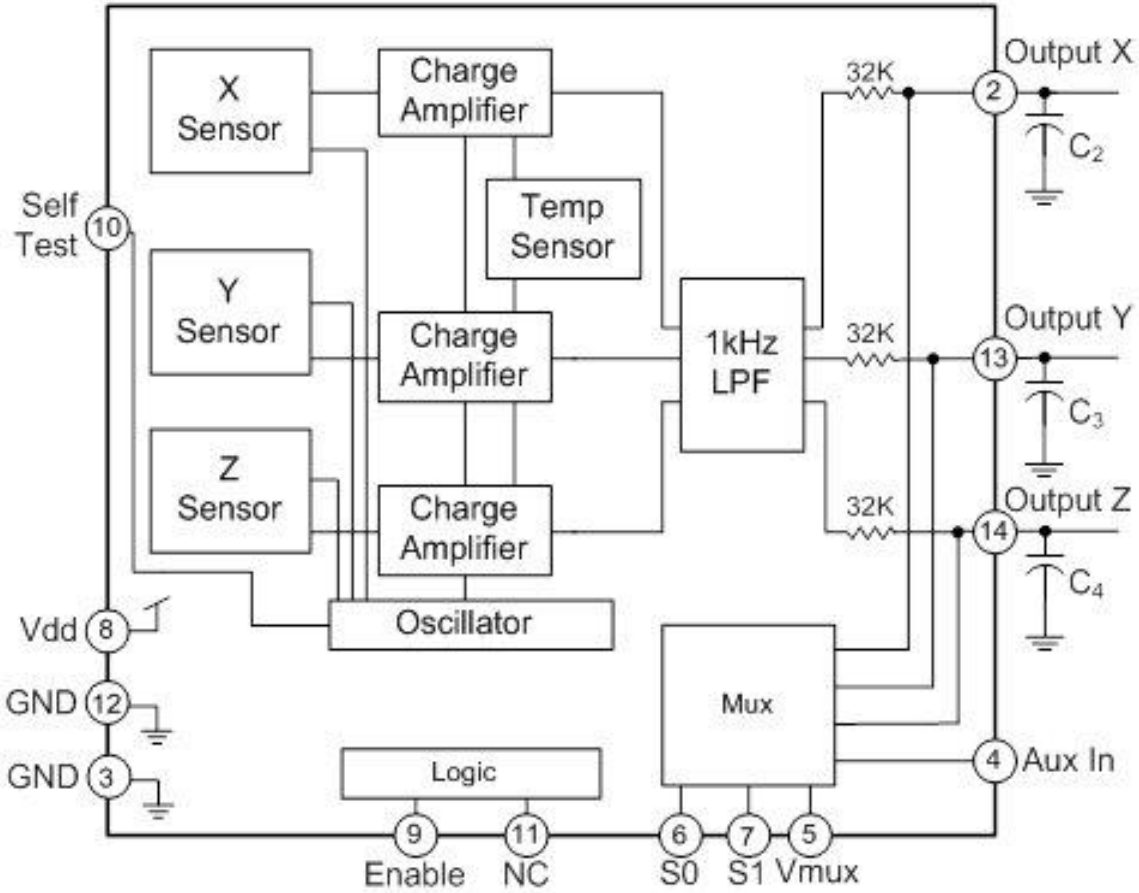



## ± 10g Tri-axis Accelerometer Specifications

**PART NUMBER:**

**KXD94-2802  
Rev. 2  
May-2014**

### Product Specifications

**Table 1. Mechanical**

(specifications are for operation at 5V and T = 25C unless stated otherwise)

Parameters	Units	Min	Typical	Max
Operating Temperature Range	°C	-40	-	85
Zero-g Offset	! V	2.45	2.5	2.55
Zero-g Offset Variation from RT over Temp.	mg/°C		1	
Sensitivity	! mV/g	193	200	207
Sensitivity Variation from RT over Temp.	%/°C		0.01	
Offset Ratiometric Error (Vdd = 5V ± 5%)	mg		0.2 (xy) 0.1 (z)	
Sensitivity Ratiometric Error (Vdd = 5V ± 5%)	%		1.6 (xy) 0.2 (z)	
Non-Linearity	% of FS		0.1	
Cross Axis Sensitivity	%		2	
Self Test Output change on Activation	g		6.5 (xy) 3.6 (z)	
Bandwidth (-3dB) <sup>1</sup>	Hz	640	800	960
Noise Density (on filter pins)	µg / √Hz		100	

**! Denotes Special Characteristics: These characteristics have been identified as important to the customer.**

**Notes:**

1. Internal 1 kHz low pass filter. Lower frequencies are user definable with external capacitors.



## ± 10g Tri-axis Accelerometer Specifications

PART NUMBER:

KXD94-2802  
Rev. 2  
May-2014

**Table 2. Electrical**

(specifications are for operation at 5V and T = 25C unless stated otherwise)

Parameters		Units	Min	Typical	Max
Supply Voltage (V <sub>dd</sub> )	Operating <sup>1,2</sup>	V	2.5	5	5.25
Current Consumption	Operating <sup>3</sup>	! μA	900	1200	1500
	Standby	μA		-	5
Input Low Voltage <sup>4</sup>		V	-	-	0.2 * V <sub>dd</sub>
Input High Voltage <sup>5</sup>		V	0.8 * V <sub>dd</sub>	-	-
Analog Output Resistance (R <sub>out</sub> )		kΩ	24	32	40

**! Denotes Special Characteristics: These characteristics have been identified as important to the customer.**

**Notes:**

1. Supply voltage must be ramped to 80% of V<sub>dd</sub> in 60mSec or less. The ASIC does not monitor V<sub>dd</sub> voltage levels and ramping V<sub>dd</sub> may result in failure. Note- The voltage can not cycle during the start-up period.
2. The operating voltage range of the KXD94 is 2.5V to 5.25V but the performance for that range is not validated by this specification.
3. Tolerance for current at V<sub>dd</sub>=5v.
4. Voltage level for logic '0'. I.e. disable selftest function
5. Voltage level for logic '1'. I.e. enable selftest function

	<b>± 10g Tri-axis Accelerometer Specifications</b>	<b>PART NUMBER:</b>  <b>KXD94-2802</b> <b>Rev. 2</b> <b>May-2014</b>
---	--	--

**Table 3. Environmental**

Parameters		Units	Min	Target	Max
Supply Voltage (V <sub>dd</sub> )	Absolute Limits	V	-0.3	-	7.0
Maximum Operating Temperature Range		°C	-40	-	125
Storage Temperature Range		°C	-55	-	150
Mech. Shock (powered and unpowered) <sup>6</sup>		g	-	-	5000 for 0.5ms
ESD	HBM	V	-	-	3000

6. Mechanical shock abuse can cause offset shifts



Caution: ESD Sensitive and Mechanical Shock Sensitive Component, improper handling can cause permanent damage to the device.



This product conforms to Directive 2002/95/EC of the European Parliament and of the Council of the European Union (RoHS). Specifically, this product does not contain lead, mercury, cadmium, hexavalent chromium, polybrominated biphenyls (PBB), or polybrominated diphenyl ethers (PBDE) above the maximum concentration values (MCV) by weight in any of its homogenous materials. Homogenous materials are "of uniform composition throughout."



This product is halogen-free per IEC 61249-2-21. Specifically, the materials used in this product contain a maximum total halogen content of 1500 ppm with less than 900-ppm bromine and less than 900-ppm chlorine.

**Soldering**

Soldering recommendations available upon request or from [www.kionix.com](http://www.kionix.com).



# ± 10g Tri-axis Accelerometer Specifications

PART NUMBER:

KXD94-2802  
Rev. 2  
May-2014

## Application Schematic

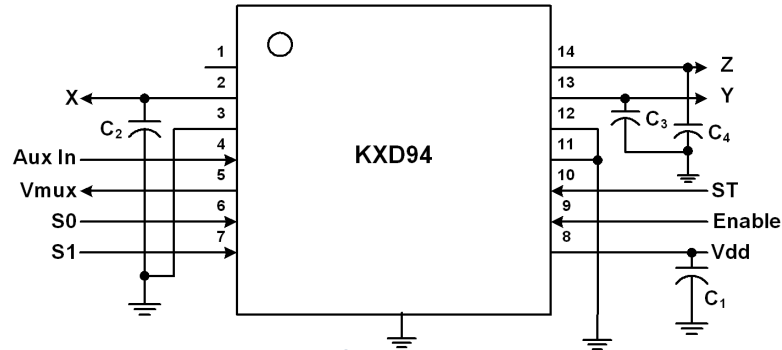

Table 4. KXD94 Pad Descriptions

Pad	Name	Description
1	NC	Not Connected Internally (can be connected to Vdd or Gnd)
2	X output	Analog output of the x-channel. Optionally, a capacitor (C <sub>2</sub> ) placed between this pin and ground will form a low pass filter. Connect to Vdd or Ground if not used.
3	GND	Ground
4	Aux In	Auxiliary input for multiplexer. Connect to Vdd or Ground if not used. Input Impedance is 1KΩ
5	Vmux	Multiplexed analog output. Do not connect if multiplexer is not used.
6	S0	MUX selector 0 (See Output Select Table). Connect to Vdd or Ground if not used.
6'	SDO	SPI Serial Data Output
7	S1	MUX selector 1 (See Output Select Table). Connect to Vdd or Ground if not used.
7'	SCLK	SPI Communication Clock
8	Vdd	The power supply input. Decouple this pin to ground with a 0.1uF ceramic capacitor (C <sub>1</sub> ).
9	Enable	Enable: <b>High</b> - Normal operation; <b>Low</b> - Device is in standby, power down mode
9'	nCS	SPI Chip Select
10	ST	Self test. The output of a properly functioning part will increase when Vdd is applied to the self-test pin. (see Table 2)
10'	SDI	SPI Serial Data Input
11	NC	Not Connected Internally (can be connected to Vdd or Gnd)
12	GND	Ground
13	Y Output	Analog output of y-channel. Optionally, a capacitor (C <sub>3</sub> ) placed between this pin and ground will form a low pass filter. Connect to Vdd or Ground if not used.
14	Z Output	Analog output of z-channel. Optionally, a capacitor (C <sub>4</sub> ) placed between this pin and ground will form a low pass filter. Connect to Vdd or Ground if not used.
	Center pad	Ground

Note 1: Pins 6,7,9,and 10 are used for SPI communication when nCS (Chip Select) is low.

### **Important Technical Note: Power Up / Power Down**

Proper functioning of power-on reset (POR) is dependent on the specific Voff and Toff profile of individual applications. It is recommended to minimize Voff and maximize Toff. The application should be evaluated with the range of Voff and Toff expected within the application as POR performance can vary depending on these parameters. In order to guarantee proper reset regardless of Voff and Toff, a software reset can be issued via the SPI protocol. Please refer to Technical Note **KXR94 and KXD94 Accelerometer Reset Sequence** document to ensure proper POR function in your application.



**± 10g Tri-axis Accelerometer  
Specifications**

**PART NUMBER:**

**KXD94-2802  
Rev. 2  
May-2014**





## ± 10g Tri-axis Accelerometer Specifications

PART NUMBER:

KXD94-2802  
Rev. 2  
May-2014

### Application Design Equations

The bandwidth is determined by the internal 1kHz low pass filter. The user can lower the bandwidth by placing filter capacitors connected from pins 2, 13 and 14 to ground. The response is single pole. Given a desired bandwidth,  $f_{BW}$ , the filter capacitors are determined by:

$$C_2 = C_3 = C_4 = \frac{4.97 \times 10^{-6}}{f_{BW}}$$

The response time (RT) is determined by the equation:

$$RT = 5 \times R_{int} \times C_{ext}$$

$R_{int}$  is the 32KΩ internal resistor.  $C_{ext}$  is the external resistor  $C_2$ ,  $C_3$ , and  $C_4$ .

Output is a function of t (time) for constant Resistance and Capacitance.  $Out_{in}$  is the output during normal operation. The function for output during selftest actuation is described by:

$$Output = Out_{in} * (1 - e^{-t/RC})$$

### Power Up / Power Down

Proper functioning of power-on reset (POR) is dependent on the specific Voff and Toff profile of individual applications. It is recommended to minimize Voff and maximize Toff. The application should be evaluated with the range of Voff and Toff expected within the application as POR performance can vary depending on these parameters.



## ± 10g Tri-axis Accelerometer Specifications

PART NUMBER:

KXD94-2802  
Rev. 2  
May-2014

### Multiplexed Output of the KXD94

#### ***Multiplexer Data Select***

The KXD94 features an integrated 4-channel multiplexer. This feature reduces system MCU requirements to only 1 ADC and 2 digital I/O's. The KXD94 uses two select inputs (S0, S1) to control the data flow from Vmux, which is a high impedance output. When a microprocessor toggles the select inputs, the desired output is attained based on the Output Select Table 5. Note that logic 0 is GND and logic 1 is Vdd.

**Table 5. Output Select Table**

S0	S1	Vmux
0	0	X Output
0	1	Z Output
1	0	Y Output
1	1	Aux. In

#### ***Data Sampling Rate***

When operating in its multiplexed mode, the KXD94 has the ability to achieve very high data sampling rates. Internally, the sensor elements (X, Y) are sequentially sampled in a "round robin" fashion at a rate of 32KHz per axis. Note that this is a differential capacitance sampling of each sensor element, which stores an analog voltage on the filter cap for each axis. Combine this high sensor element-sampling rate with the short 5µs settling time of the integrated multiplexer, and the user can achieve a performance very close to that of the X and Y analog outputs. This is more than sufficient to eliminate any aliasing in the final application since the KXD94 will be operating with a typical bandwidth of ~50Hz and a maximum of 1000Hz.

	<b>± 10g Tri-axis Accelerometer Specifications</b>	<b>PART NUMBER:</b>  <b>KXD94-2802 Rev. 2 May-2014</b>
---	--	--

### KXD94 Digital Interface

The Kionix KXD94 digital accelerometer has the ability to communicate on a SPI digital serial interface bus. This flexibility allows for easy system integration by eliminating analog-to-digital converter requirements and by providing direct communication with system micro-controllers.

The serial interface terms and descriptions as indicated in Table 6 below will be observed throughout this document.

**Table 6. Serial Interface Terminologies**

Term	Description
Transmitter	The device that transmits data to the bus.
Receiver	The device that receives data from the bus.
Master	The device that initiates a transfer generates clock signals and terminates a transfer.
Slave	The device addressed by the Master.

The chip will ignore all SPI activity when nCS is held high, and the analog function will run. The analog function is powered down whenever nCS is low, but the SPI bus will function, allowing communication to enable and reset the KXD94.



# ± 10g Tri-axis Accelerometer Specifications

PART NUMBER:

KXD94-2802  
Rev. 2  
May-2014

## Accelerometer SPI Reset Sequence:

1. Power up KXD94
2. Toggle nCS (Pin 9)
  - a. nCS low to select
  - b. nCS high for at least 200nS (SCLK = 5MHz)
  - c. nCS low to select
3. Send Reset Command per Figure 2 (SDI is latched on rising edges of CLK) Note that it takes 16mSec for the Reset command to execute.

Figure 2. Reset command timing Diagram

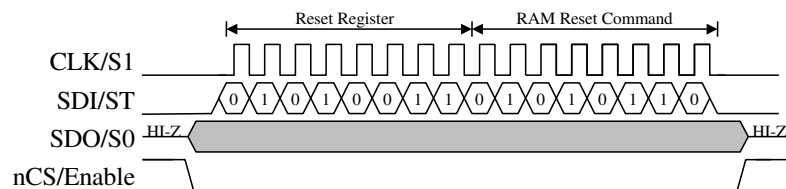

4. Set nCS to high (Logic '1') for Normal Analog Operation.

Figure 3. Application Schematic for SPI Reset

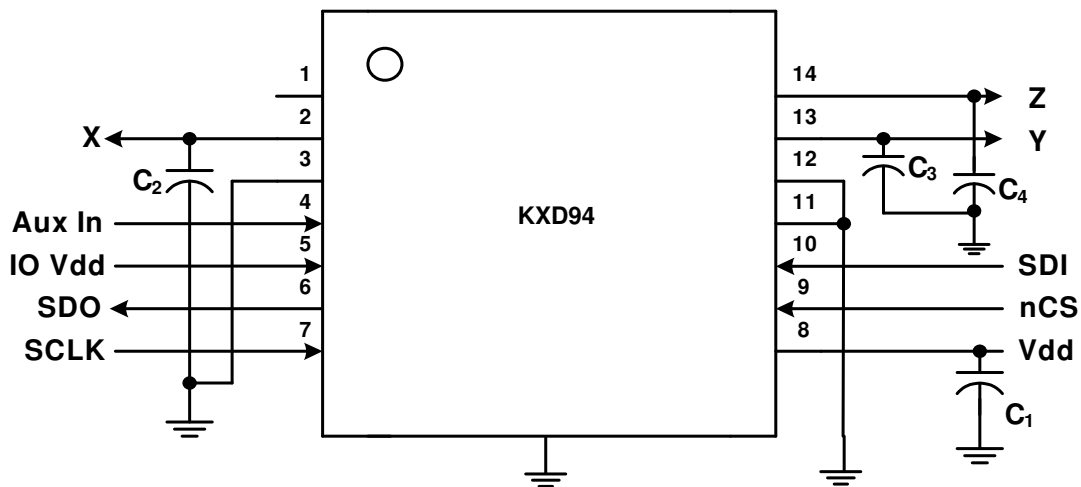



# ± 10g Tri-axis Accelerometer Specifications

PART NUMBER:

KXD94-2802  
Rev. 2  
May-2014

## Self Test Function

The selftest is activated when 'logic 1' is applied to the ST pin (See Figure 1). An electrostatic force is applied to the sense element that causes the mass to move and the output increases. The selftest function exercises the X and Y sense elements and ASIC blocks. The output change of the selftest function is modified by the internal 1kHz LPF and the external LPF that is defined by the ASIC internal resistance and the external capacitor. Figure 4 is an example of the selftest output with a 50Hz external LPF. The selftest is actuated at 10 Hz and 25% duty cycle.

Figure 4: Selftest Function for KXD94

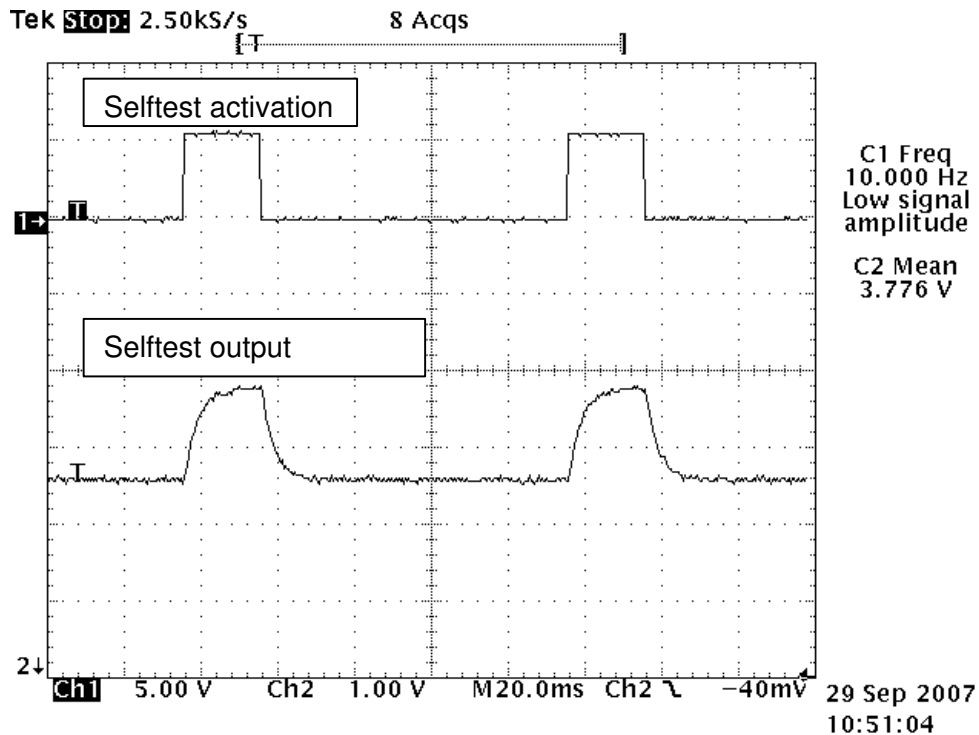





## ± 10g Tri-axis Accelerometer Specifications

PART NUMBER:

KXD94-2802  
Rev. 2  
May-2014

### Test Specifications

The performance parameters and characteristics are validated by Design methodology; Design Validation tests; and Product-Production Validation tests. A test control plan has been developed to verify product conformance to specification prior to shipment. Table 7 is a summary of these tests.

**Table 7. Test Specifications**

Parameter	Specification	Test Conditions
Zero-g Offset @ RT	2.5 +/- 0.05 V	25C, Vdd = 5 V
Sensitivity @ RT	200 +/- 7 mV/g	25C, Vdd = 5 V
Current Consumption -- Operating	900 <= Idd <= 1500 uA	25C, Vdd = 5 V



# ± 10g Tri-axis Accelerometer Specifications

PART NUMBER:

KXD94-2802  
Rev. 2  
May-2014

## Package Dimensions and Orientation

Figure 5. 5x5x1.2mm DFN Package and Acceleration sign convention

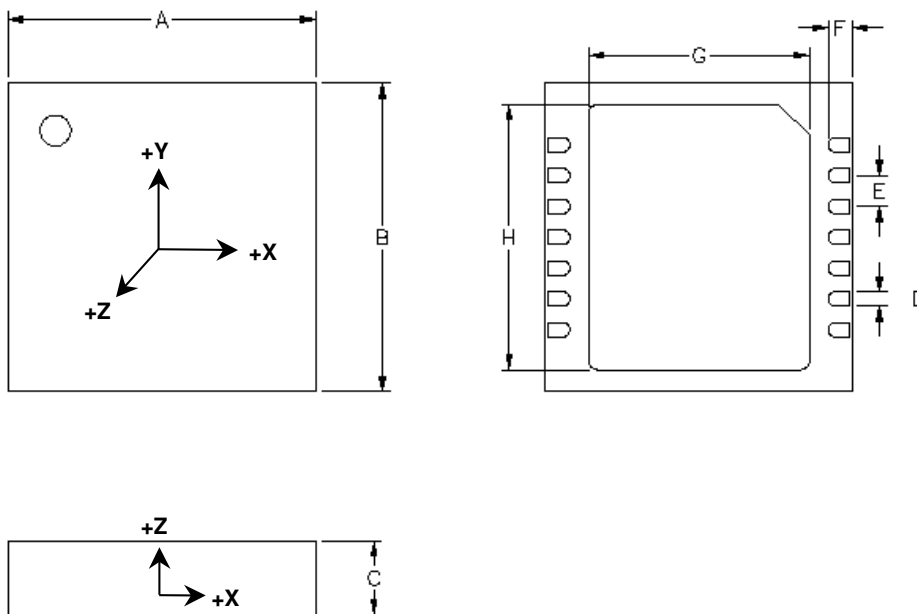

All dimensions and tolerances conform to ASME Y14.5M-1994

Dimension	mm			inch		
	Min	Nom	Max	Min	Nom	Max
A		5.00			0.197	
B		5.00			0.197	
C	1.10	1.20	1.30	0.043	0.047	0.051
D	0.18	0.23	0.28	0.007	0.009	0.011
E		0.50			0.020	
F	0.35	0.40	0.45	0.014	0.016	0.018
G	3.50	3.60	3.70	0.138	0.142	0.146
H	4.20	4.30	4.40	0.165	0.169	0.173

When device is accelerated in +X, +Y, and +Z direction, the corresponding output will increase.



## ± 10g Tri-axis Accelerometer Specifications

**PART NUMBER:**

**KXD94-2802  
Rev. 2  
May-2014**

### Static X/Y Output Response versus Orientation to Earth's surface (1g):

(Outputs for ±1.33g KXD94)

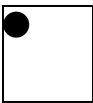
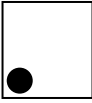
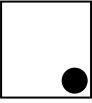
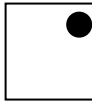
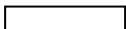
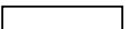
Position	1	2	3	4	5	6
Diagram					Top  Bottom	Bottom  Top
X	2.5 V	2.7 V	2.5 V	2.3 V	2.5 V	2.5 V
Y	2.7 V	2.5 V	2.3 V	2.5 V	2.5 V	2.5 V
Z	2.5 V	2.5 V	2.5 V	2.5 V	2.7 V	2.3 V
Polarity	0	+	0	-	0	0
Polarity	+	0	-	0	0	0
Polarity	0	0	0	0	+	-

↓ (1g)

Earth's Surface

	<b>± 10g Tri-axis Accelerometer Specifications</b>	<b>PART NUMBER:</b>  <b>KXD94-2802</b> <b>Rev. 2</b> <b>May-2014</b>
---	--	--

**Revision History**

REVISION	DESCRIPTION	DATE
1	Updated approval list. Corrected Table 4 pin description for AUX In.	05-Oct-2009
2	Added POR design note	12-May-2014

"Kionix" is a registered trademark of Kionix, Inc. Products described herein are protected by patents issued or pending. No license is granted by implication or otherwise under any patent or other rights of Kionix. The information contained herein is believed to be accurate and reliable but is not guaranteed. Kionix does not assume responsibility for its use or distribution. Kionix also reserves the right to change product specifications or discontinue this product at any time without prior notice. This publication supersedes and replaces all information previously supplied.