



Chipsmall Limited consists of a professional team with an average of over 10 year of expertise in the distribution of electronic components. Based in Hongkong, we have already established firm and mutual-benefit business relationships with customers from,Europe,America and south Asia,supplying obsolete and hard-to-find components to meet their specific needs.

With the principle of “Quality Parts,Customers Priority,Honest Operation,and Considerate Service”,our business mainly focus on the distribution of electronic components. Line cards we deal with include Microchip,ALPS,ROHM,Xilinx,Pulse,ON,Everlight and Freescale. Main products comprise IC,Modules,Potentiometer,IC Socket,Relay,Connector.Our parts cover such applications as commercial,industrial, and automotives areas.

We are looking forward to setting up business relationship with you and hope to provide you with the best service and solution. Let us make a better world for our industry!



Contact us

Tel: +86-755-8981 8866 Fax: +86-755-8427 6832

Email & Skype: info@chipsmall.com Web: www.chipsmall.com

Address: A1208, Overseas Decoration Building, #122 Zhenhua RD., Futian, Shenzhen, China





LUXEON 3030 HV

High flux, hot-color targeted,
24V and 48V mid power packages

LUXEON 3030 HV is an industry standard package to optimize total voltage output, available in 24V and 48V. This high voltage at low current architecture allows system design freedom and is compatible with more efficient and cost effective drivers. This mid power LED is 1/9th micro-color binned for tight color control and hot-color targeted to ensure that the LEDs are within color target at application conditions—85°C. LUXEON 3030 HV delivers efficacy and reliability for a variety of applications such as downlights, lamps and spotlights.

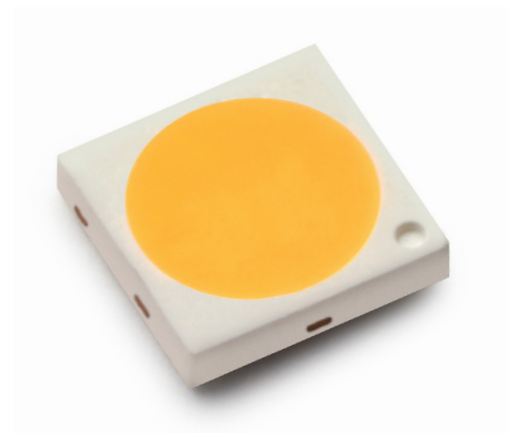

FEATURES AND BENEFITS

High voltage at low current, compatible with more efficient and cost effective drivers

24V and 48V options available to optimize total voltage output

1/9th micro color binning and 85°C hot-color targeting enables tight color control

EMC based package affirms lumen maintenance and long lifetime

PRIMARY APPLICATIONS

Downlights

Lamps

Spotlights

Table of Contents

General Product Information	2
Product Test Conditions	2
Part Number Nomenclature	2
Lumen Maintenance	2
Environmental Compliance	2
Performance Characteristics	3
Product Selection Guide	3
Optical Characteristics	3
Electrical and Thermal Characteristics	4
Absolute Maximum Ratings	4
Characteristic Curves	5
Spectral Power Distribution Characteristics	5
Light Output Characteristics	6
Forward Current Characteristics	8
Radiation Pattern Characteristics	9
Product Bin and Labeling Definitions	10
Decoding Product Bin Labeling	10
Luminous Flux Bins	10
Color Bin Definitions	11
Forward Voltage Bins	15
Mechanical Dimensions	15
Reflow Soldering Guidelines	16
JEDEC Moisture Sensitivity	16
Solder Pad Design	17
Packaging Information	17
Pocket Tape Dimensions	17
Reel Dimensions	18

General Product Information

Product Test Conditions

LUXEON 3030 HV LEDs are tested with a 20ms monopulse of 34mA for LUXEON 3030 HV 24V and 17mA for LUXEON 3030 HV 48V parts at a junction temperature, T_j , of 25°C. Forward voltage and luminous flux are binned at a T_j of 25°C, while color is hot targeted at a T_j of 85°C.

Part Number Nomenclature

Part numbers for LUXEON 3030 HV follow the convention below:

L 1 3 0 – **A A B B C C** H V 0 0 0 0 1

Where:

- A A** – designates nominal CCT (27=2700K, 30=3000K, 35=3500K, 40=4000K, 50=5000K, 57=5700K, 65=6500K)
- B B** – designates minimum CRI (80=80CRI, 90=90CRI)
- C C** – designates voltage (0B=24V and 0C=48V)

Therefore, the following part number is used for a LUXEON 3030 HV 3000K 80CRI 24V:

L 1 3 0 – **3 0 8 0 0 B** H V 0 0 0 0 1

Lumen Maintenance

Please contact your local Sales Representative or Lumileds Technical Solutions Manager for more information about the long-term performance of this product.

Environmental Compliance

Lumileds LLC is committed to providing environmentally friendly products to the solid-state lighting market. LUXEON 3030 HV is compliant to the European Union directives on the restriction of hazardous substances in electronic equipment, namely the RoHS Directive 2011/65/EU and REACH Regulation (EC) 1907/2006. Lumileds LLC will not intentionally add the following restricted materials to its products: lead, mercury, cadmium, hexavalent chromium, polybrominated biphenyls (PBB) or polybrominated diphenyl ethers (PBDE).

Performance Characteristics

Product Selection Guide

Table 1. Product performance of LUXEON 3030 HV at specified test current and temperature.

VOLTAGE	NOMINAL CCT ^[1]	MINIMUM CRI ^[2, 3]	LUMINOUS FLUX ^[2, 3] (lm)		TYPICAL LUMINOUS EFFICACY (lm/W)	TEST CURRENT (mA)	PART NUMBER
			MINIMUM	TYPICAL			
24V	2700K	80	97	107	132	34	L130-27800BHV00001
	3000K	80	99	109	135	34	L130-30800BHV00001
	3500K	80	102	112	139	34	L130-35800BHV00001
	4000K	80	107	117	145	34	L130-40800BHV00001
	5000K	80	107	117	145	34	L130-50800BHV00001
	5700K	80	107	117	145	34	L130-57800BHV00001
	6500K	80	107	117	145	34	L130-65800BHV00001
	2700K	90	87	92	114	34	L130-27900BHV00001
48V	3000K	90	90	95	116	34	L130-30900BHV00001
	2700K	80	97	107	132	17	L130-27800CHV00001
	3000K	80	99	109	135	17	L130-30800CHV00001
	3500K	80	102	112	139	17	L130-35800CHV00001
	4000K	80	107	117	145	17	L130-40800CHV00001
	5000K	80	107	117	145	17	L130-50800CHV00001
	5700K	80	107	117	145	17	L130-57800CHV00001
	6500K	80	107	117	145	17	L130-65800CHV00001
	2700K	90	87	92	114	17	L130-27900CHV00001

Notes for Table 1:

1. Correlated color temperature is not targeted at $T_j=85^\circ\text{C}$.
2. Luminous flux and CRI specs are based upon mounted package on highly reflective surface at $T_j=25^\circ\text{C}$. Typical CRI is approximately 2 points higher than the minimum CRI specified, but this is not guaranteed.
3. Lumileds maintains a tolerance of ± 2 on CRI and $\pm 7.5\%$ on luminous flux measurements.

Optical Characteristics

Table 2. Optical characteristics for LUXEON 3030 HV at test current, $T_j=25^\circ\text{C}$.

PART NUMBER	TYPICAL TOTAL INCLUDED ANGLE ^[1]	TYPICAL VIEWING ANGLE ^[2]
L130-XXXXXXHV00001	140°	116°

Notes for Table 2:

1. Total angle at which 90% of total luminous flux is captured.
2. Viewing angle is the off axis angle from the LED centerline where the luminous intensity is $\frac{1}{2}$ of the peak value.

Electrical and Thermal Characteristics

Table 3. Electrical and thermal characteristics for LUXEON 3030 HV at test current, $T_j=25^{\circ}\text{C}$.

PART NUMBER	FORWARD VOLTAGE ^[1] (V_f)			TYPICAL TEMPERATURE COEFFICIENT OF FORWARD VOLTAGE ^[2] (mV/ $^{\circ}\text{C}$)	TYPICAL THERMAL RESISTANCE — JUNCTION TO SOLDER PAD ($^{\circ}\text{C}/\text{W}$)
	MINIMUM	TYPICAL	MAXIMUM		
L130-XXXXXBHV00001	22.5	24.0	25.0	-13	12
L130-XXXXXCHV00001	45.0	48.0	50.0	-26	12

Notes for Table 3:

1. Lumileds maintains a tolerance of $\pm 0.1\text{V}$ on forward voltage measurements.
2. Measured between 25°C and 85°C .

Absolute Maximum Ratings

Table 4. Absolute maximum ratings for LUXEON 3030 HV.

PARAMETER	MAXIMUM PERFORMANCE
DC Forward Current ^[1,2]	60mA for L130-xxxx0BHV00001 30mA for L130-xxxx0CHV00001
Peak Pulsed Forward Current ^[1,3]	80mA for L130-xxxx0BHV00001 40mA for L130-xxxx0CHV00001
LED Junction Temperature ^[1] (DC & Pulse)	125 $^{\circ}\text{C}$
ESD Sensitivity (ANSI/ESDA/JEDEC JS-001-2012)	Class 2
Operating Case Temperature ^[1]	-40 $^{\circ}\text{C}$ to 105 $^{\circ}\text{C}$
LED Storage Temperature	-40 $^{\circ}\text{C}$ to 105 $^{\circ}\text{C}$
Soldering Temperature	JEDEC 020D 260 $^{\circ}\text{C}$
Allowable Reflow Cycles	3
Reverse Voltage (V_{reverse})	LUXEON LEDs are not designed to be driven in reverse bias

Notes for Table 4:

1. Proper current derating must be observed to maintain the junction temperature below the maximum allowable junction temperature.
2. Residual periodic variations due to power conversion from alternating current (AC) to direct current (DC), also called "ripple," are acceptable if the following conditions are met:
 - The frequency of the ripple current is 100Hz or higher
 - The average current for each cycle does not exceed the maximum allowable DC forward current
 - The maximum amplitude of the ripple does not exceed 25% of the maximum allowable DC forward current
3. Pulsed operation with the maximum peak pulsed forward current is acceptable if the pulse duty cycle is $\leq 10\%$.

Characteristic Curves

Spectral Power Distribution Characteristics

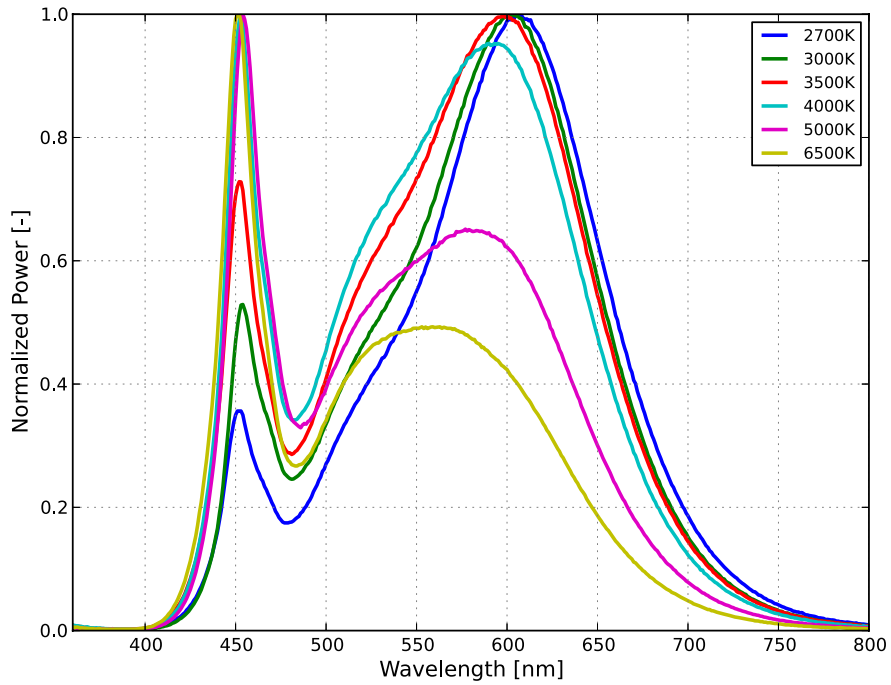

Figure 1a. Typical normalized power vs. wavelength for L130-XX80XXHV00001 at test current, $T_j=25^{\circ}\text{C}$.

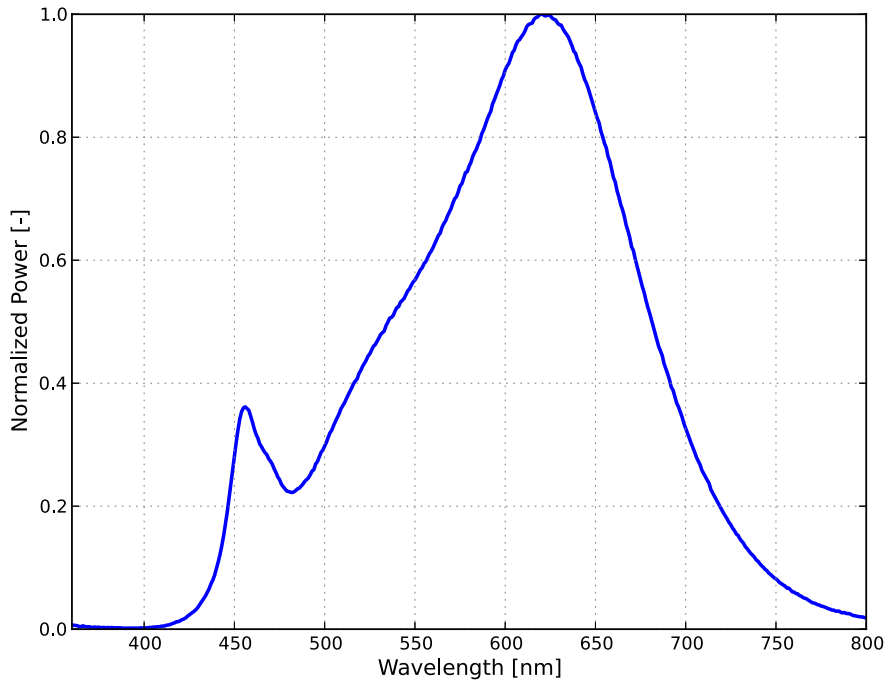

Figure 1b. Typical normalized power vs. wavelength for L130-XX90XXHV00001 at test current, $T_j=25^{\circ}\text{C}$.

Light Output Characteristics

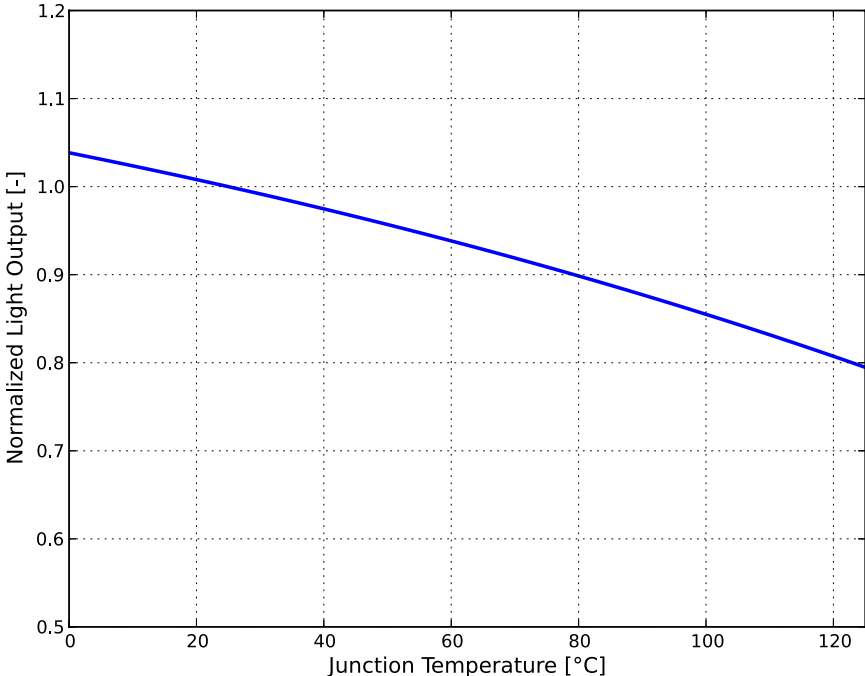

Figure 2. Typical normalized light output vs. junction temperature for L130-XXXXXXHV00001 at test current.

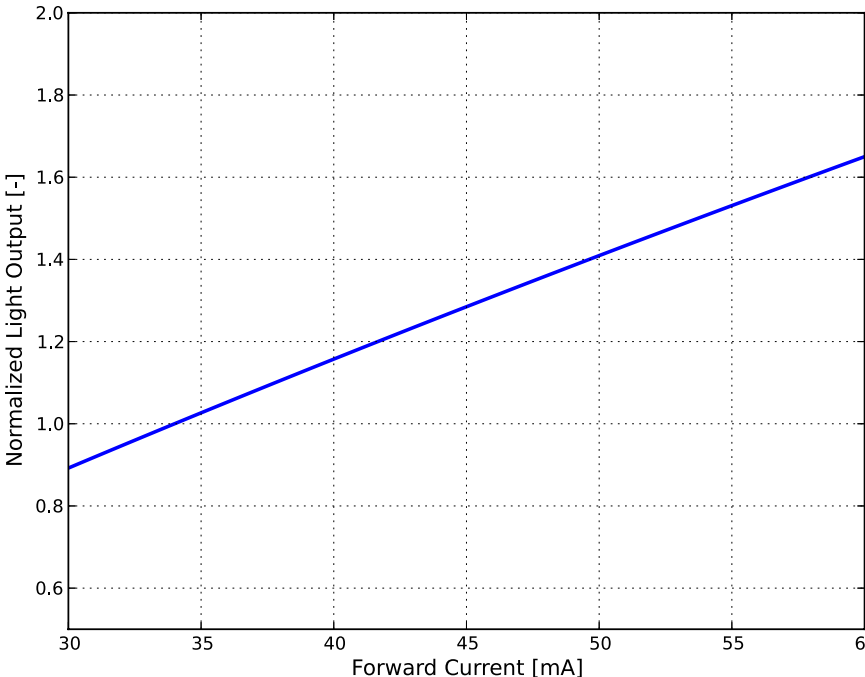

Figure 3a. Typical normalized light output vs. forward current for L130-XXXX0BHV00001 at $T_j=25^{\circ}\text{C}$.

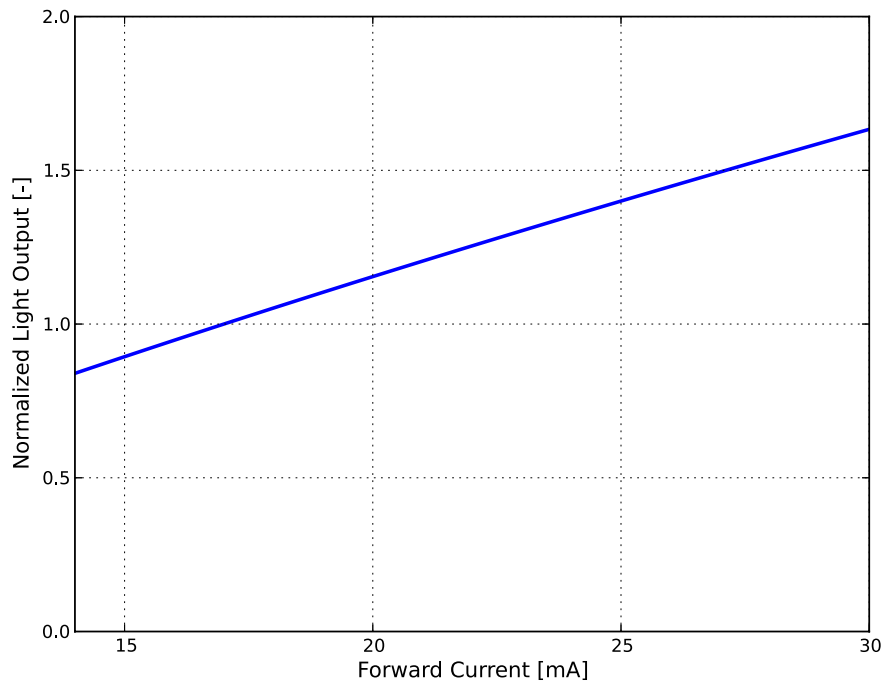

Figure 3b. Typical normalized light output vs. forward current for L130-XXXX0CHV00001 at $T_j=25^\circ\text{C}$.

Forward Current Characteristics

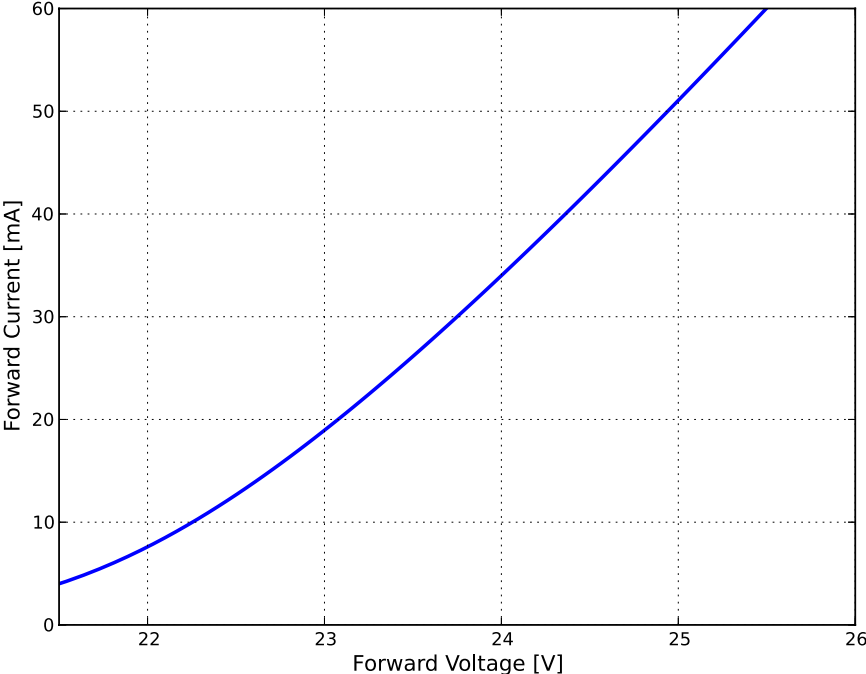

Figure 4a. Typical forward current vs. forward voltage for L130-XXXX0BHV00001 at $T_j=25^\circ\text{C}$.

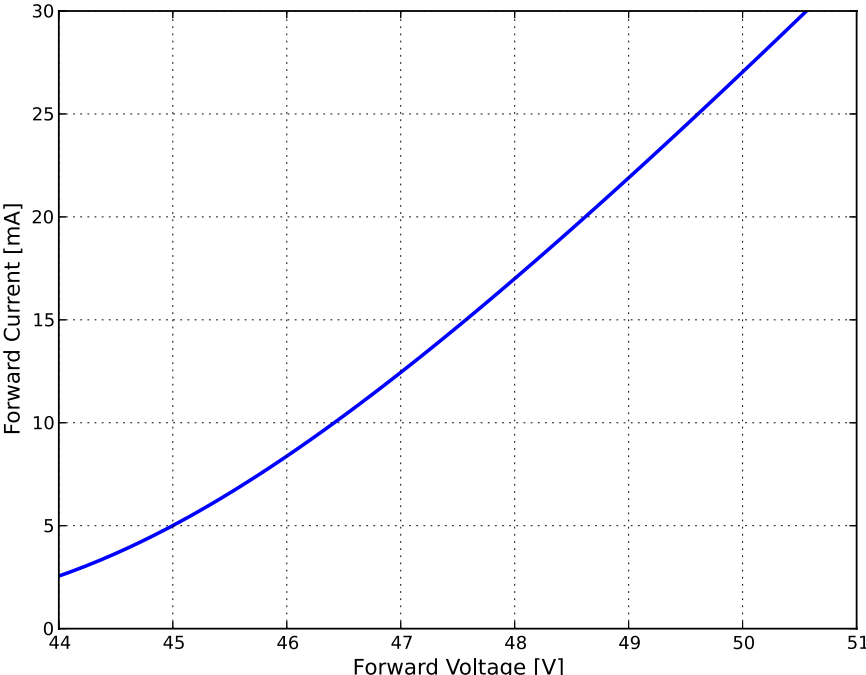

Figure 4b. Typical forward current vs. forward voltage for L130-XXXX0CHV00001 at $T_j=25^\circ\text{C}$.

Radiation Pattern Characteristics

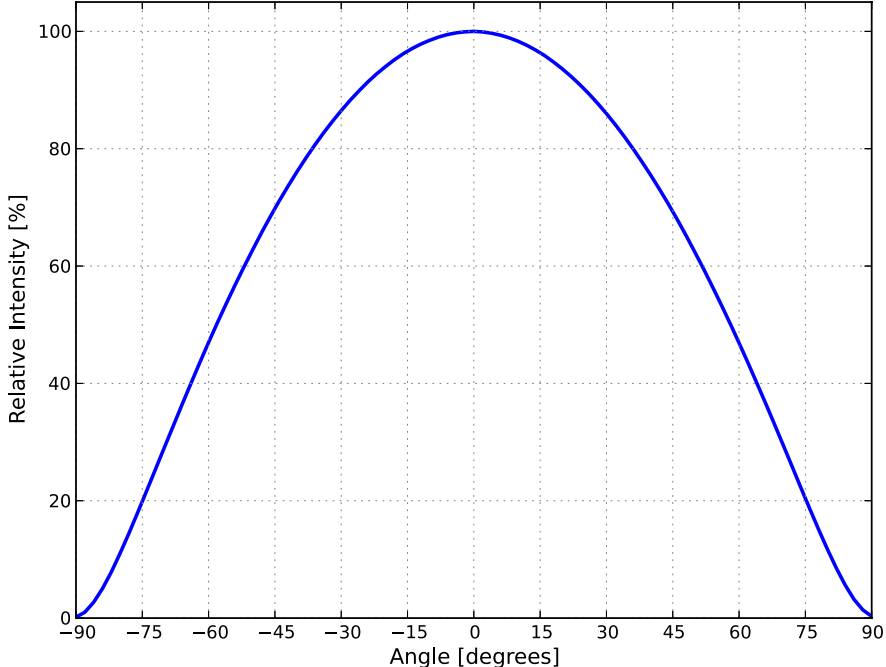

Figure 5. Typical radiation pattern for L130-XXXXXXHV00001 at test current, $T_j=25^{\circ}\text{C}$.

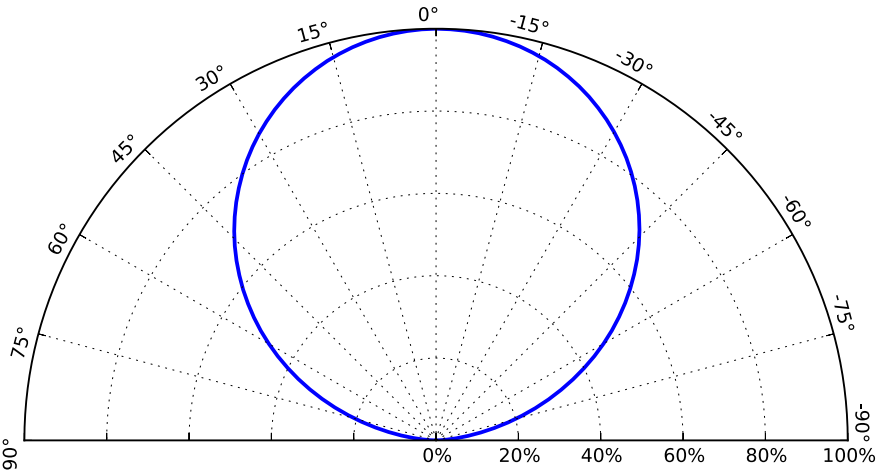

Figure 6. Typical polar radiation pattern for L130-XXXXXXHV00001 at test current, $T_j=25^{\circ}\text{C}$.

Product Bin and Labeling Definitions

Decoding Product Bin Labeling

In the manufacturing of semiconductor products, there are variations in performance around the average values given in the technical datasheet. For this reason, Lumileds bins LED components for luminous flux or radiometric power, color point, peak or dominant wavelength and forward voltage.

LUXEON 3030 HV LEDs are labeled using a 4-digit alphanumeric CAT code following the format below:

A B C D

Where:

- A** – designates luminous flux bin (example: K=100 to 105 lumens, M=110 to 115 lumens)
- B C** – designates color bin (example: 7D, 7E, 7F, 7G, 7H, 7J, 7K, 7G or 7M)
- D** – designates forward voltage bin (example: G=23 to 24V, Q=48 to 49V)

Therefore, a LUXEON 3030 HV with a lumen range of 100 to 105, color bin of 7H and forward voltage range of 23 to 24V has the following CAT code:

K 7 H G

Luminous Flux Bins

Table 5 lists the standard luminous flux bins for LUXEON 3030 HV emitters. Although several bins are outlined, product availability in a particular bin varies by production run and by product performance. Not all bins are available in all CCTs.

Table 5. Luminous flux bin definitions for LUXEON 3030 HV at test current, $T_j=25^\circ\text{C}$.

BIN	LUMINOUS FLUX ⁽¹⁾ (lm)	
	MINIMUM	MAXIMUM
G	85	90
H	90	95
J	95	100
K	100	105
L	105	110
M	110	115
N	115	120
P	120	125
Q	125	130
R	130	135
S	135	140

Notes for Table 5:

1. Lumileds maintains a tolerance of $\pm 7.5\%$ on luminous flux measurements.

Color Bin Definitions

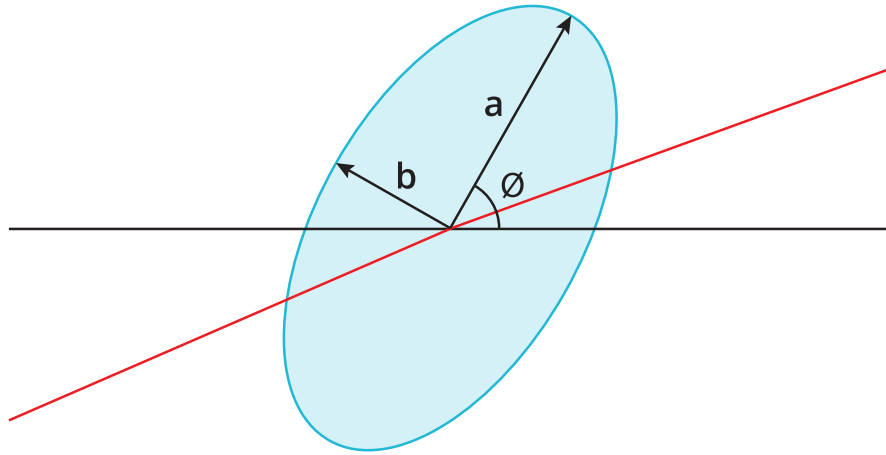

Figure 7. 3- and 5-step MacAdam ellipse illustration for tables 6a-6g.

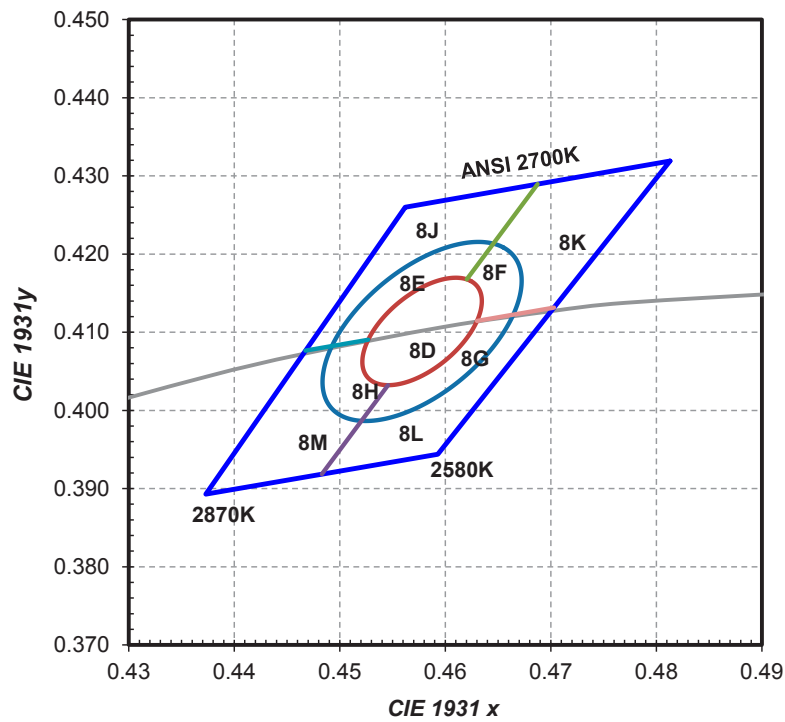

Figure 8a. 1/9th color bin structure for LUXEON 3030 HV 2700K, hot-color targeted at 85°C.

Table 6a. 3- and 5-step MacAdam ellipse color bin definitions for L130-27xxxxHV00001 at test current, hot-color targeted at 85°C.

NOMINAL CCT	COLOR SPACE	CENTER POINT ^[1] (cx, cy)	MAJOR AXIS, a	MINOR AXIS, b	ELLIPSE ROTATION ANGLE, θ
2700K	3-step MacAdam ellipse	(0.4578, 0.4101)	0.00810	0.00420	53.70°
2700K	5-step MacAdam ellipse	(0.4578, 0.4101)	0.01350	0.00700	53.70°

Notes for Table 6a:

1. Lumileds maintains a tolerance of ±0.007 on x and y coordinates in the CIE 1931 color space.

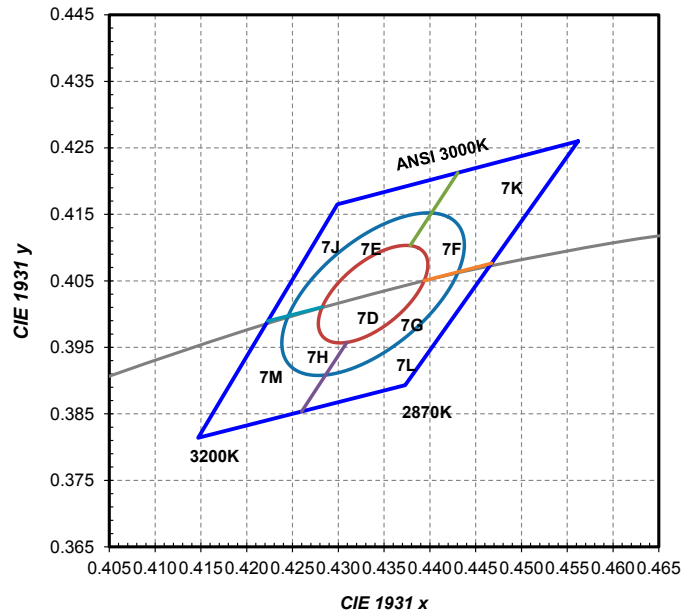

Figure 8b. 1/9th color bin structure for LUXEON 3030 HV 3000K, hot-color targeted at 85°C.

Table 6b. 3- and 5-step MacAdam ellipse color bin definitions for L130-30xxxxHV00001 at test current, hot-color targeted at 85°C.

NOMINAL CCT	COLOR SPACE	CENTER POINT ⁽¹⁾ (cx, cy)	MAJOR AXIS, a	MINOR AXIS, b	ELLIPSE ROTATION ANGLE, θ
3000K	3-step MacAdam ellipse	(0.4338, 0.4030)	0.00834	0.00408	53.22°
3000K	5-step MacAdam ellipse	(0.4338, 0.4030)	0.01390	0.00680	53.22°

Notes for Table 6b:

1. Lumileds maintains a tolerance of ± 0.007 on x and y color coordinates in the CIE 1931 color space.

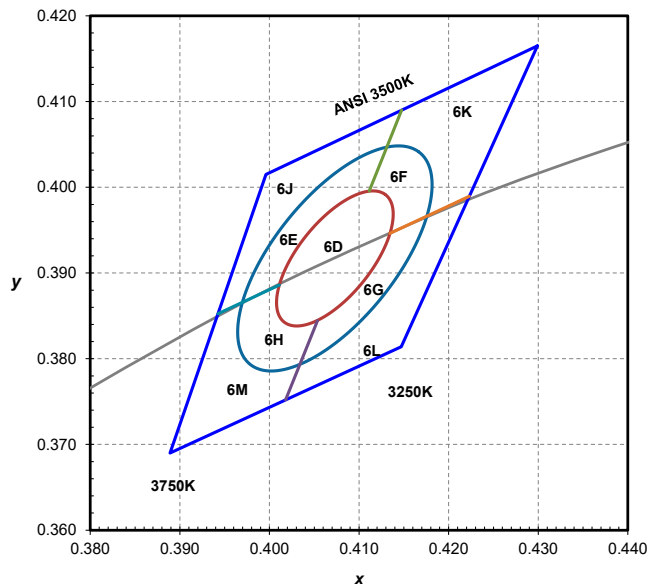

Figure 8c. 1/9th color bin structure for LUXEON 3030 HV 3500K, hot-color targeted at 85°C.

Table 6c. 3- and 5-step MacAdam ellipse color bin definitions for L130-35xx003000W21 at test current, hot-color targeted at 85°C.

NOMINAL CCT	COLOR SPACE	CENTER POINT ⁽¹⁾ (cx, cy)	MAJOR AXIS, a	MINOR AXIS, b	ELLIPSE ROTATION ANGLE, θ
3500K	Single 3-step MacAdam ellipse	(0.4073, 0.3917)	0.00927	0.00414	54.00°
3500K	Single 5-step MacAdam ellipse	(0.4578, 0.3917)	0.01545	0.00690	54.00°

Notes for Table 6c:

1. Lumileds maintains a tolerance of ± 0.007 on x and y color coordinates in the CIE 1931 color space.

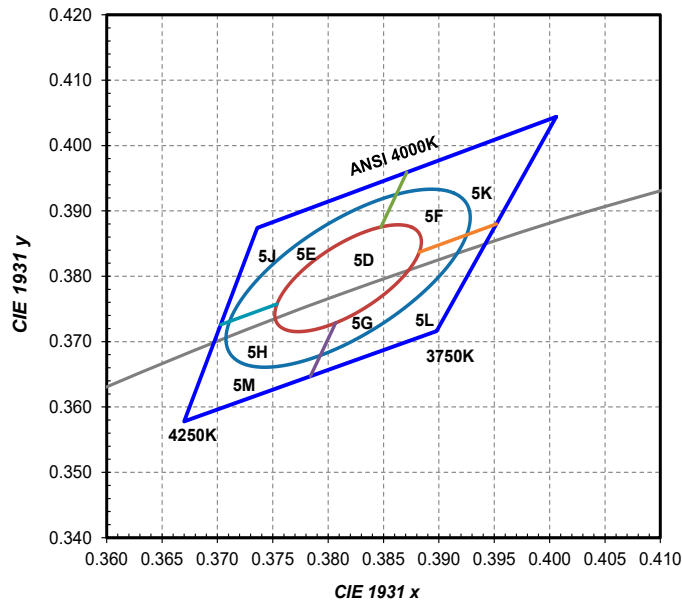

Figure 8d. 1/9th color bin structure for LUXEON 3030 HV 4000K, hot-color targeted at 85°C.

Table 6d. 3- and 5-step MacAdam ellipse color bin definitions for L130-40xxxxHV00001 at test current, hot-color targeted at 85°C.

NOMINAL CCT	COLOR SPACE	CENTER POINT ⁽¹⁾ (cx, cy)	MAJOR AXIS, a	MINOR AXIS, b	ELLIPSE ROTATION ANGLE, θ
4000K	3-step MacAdam ellipse	(0.3866, 0.3882)	0.00939	0.00402	53.72°
4000K	5-step MacAdam ellipse	(0.3866, 0.3882)	0.01565	0.00670	53.72°

Notes for Table 6d:

1. Lumileds maintains a tolerance of ± 0.007 on x and y color coordinates in the CIE 1931 color space.

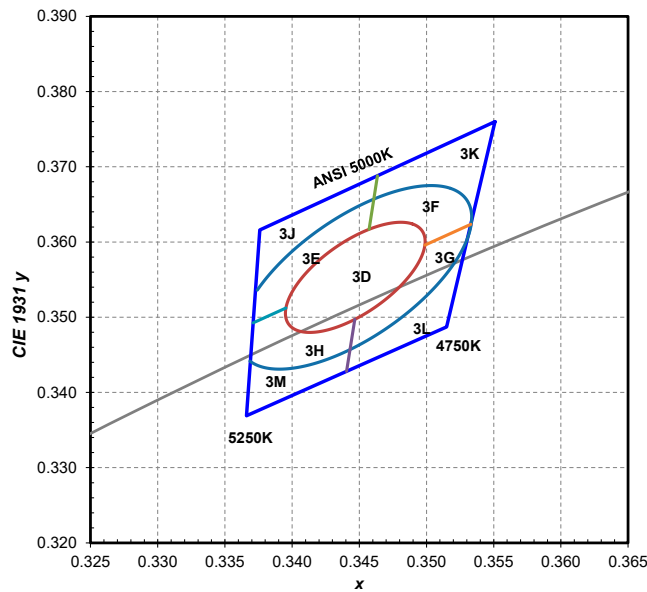

Figure 8e. 1/9th color bin structure for LUXEON 3030 HV 5000K, hot-color targeted at 85°C.

Table 6e. 3- and 5-step MacAdam ellipse color bin definitions for L130-50xxxxHV00001 at test current, hot-color targeted at 85°C.

NOMINAL CCT	COLOR SPACE	CENTER POINT ⁽¹⁾ (cx, cy)	MAJOR AXIS, a	MINOR AXIS, b	ELLIPSE ROTATION ANGLE, θ
5000K	3-step MacAdam ellipse	(0.3447, 0.3558)	0.00822	0.00354	59.62°
5000K	5-step MacAdam ellipse	(0.3447, 0.3558)	0.01370	0.00590	59.62°

Notes for Table 6e:

1. Lumileds maintains a tolerance of ± 0.007 on x and y color coordinates in the CIE 1931 color space.

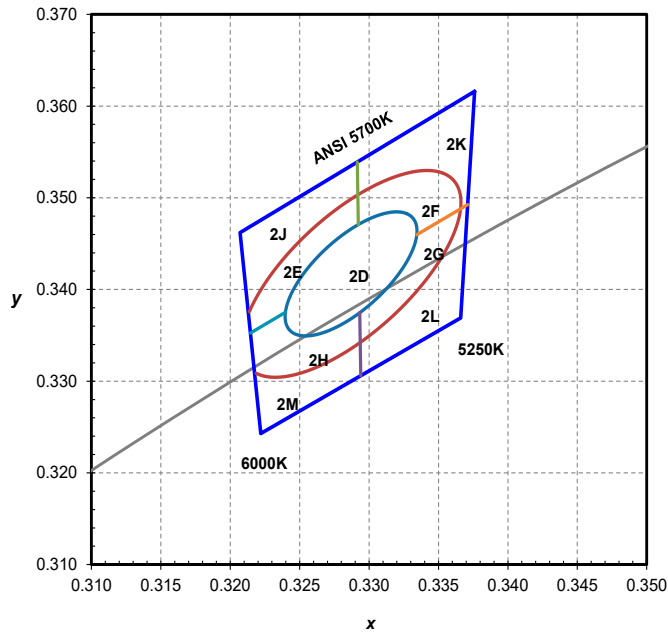

Figure 8f. 1/9th color bin structure for LUXEON 3030 HV 5700K, hot-color targeted at 85°C.

Table 6f. 3- and 5-step MacAdam ellipse color bin definitions for L130-57xxxHV00001 at test current, hot-color targeted at 85°C.

NOMINAL CCT	COLOR SPACE	CENTER POINT ^[1] (cx, cy)	MAJOR AXIS, a	MINOR AXIS, b	ELLIPSE ROTATION ANGLE, θ
5700K	3-step MacAdam ellipse	(0.3287, 0.3417)	0.00746	0.00320	59.09°
5700K	5-step MacAdam ellipse	(0.3287, 0.3417)	0.01243	0.00533	59.09°

Notes for Table 6f:

1. Lumileds maintains a tolerance of ± 0.007 on x and y color coordinates in the CIE 1931 color space.

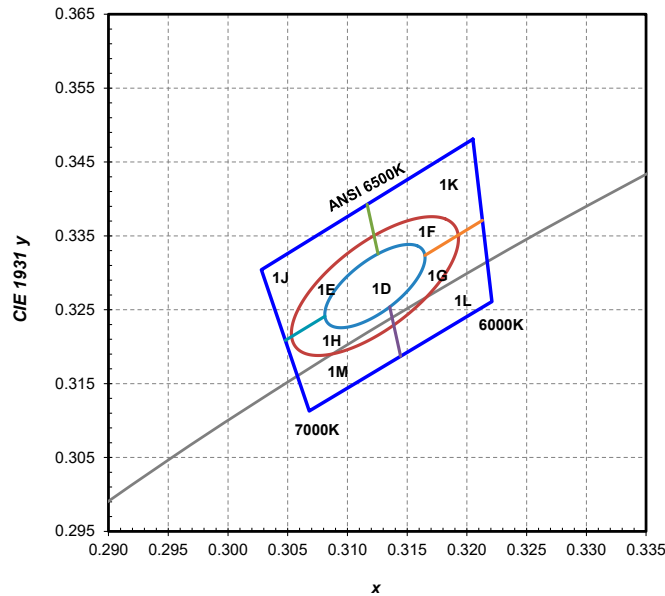

Figure 8g. 1/9th color bin structure for LUXEON 3030 HV 6500K, hot-color targeted at 85°C.

Table 6g. 3- and 5-step MacAdam ellipse color bin definitions for L130-65xxxHV00001 at test current, hot-color targeted at 85°C.

NOMINAL CCT	COLOR SPACE	CENTER POINT ^[1] (cx, cy)	MAJOR AXIS, a	MINOR AXIS, b	ELLIPSE ROTATION ANGLE, θ
6500K	3-step MacAdam ellipse	(0.3123, 0.3282)	0.00669	0.00285	58.57°
6500K	5-step MacAdam ellipse	(0.3123, 0.3282)	0.01115	0.00475	58.57°

Notes for Table 6g:

1. Lumileds maintains a tolerance of ± 0.007 on x and y color coordinates in the CIE 1931 color space.

Forward Voltage Bins

Table 7. Forward voltage bin definitions for LUXEON 3030 HV at test current, $T_j=25^\circ\text{C}$.

VOLTAGE	BIN	FORWARD VOLTAGE ^[1] (V _f)	
		MINIMUM	MAXIMUM
24	F	22	23
	G	23	24
	H	24	25
48	L	45	46
	M	46	47
	P	47	48
	Q	48	49
	R	49	50

Notes for Table 7:

1. Lumileds maintains a tolerance of $\pm 0.1\text{V}$ on forward voltage measurements.

Mechanical Dimensions

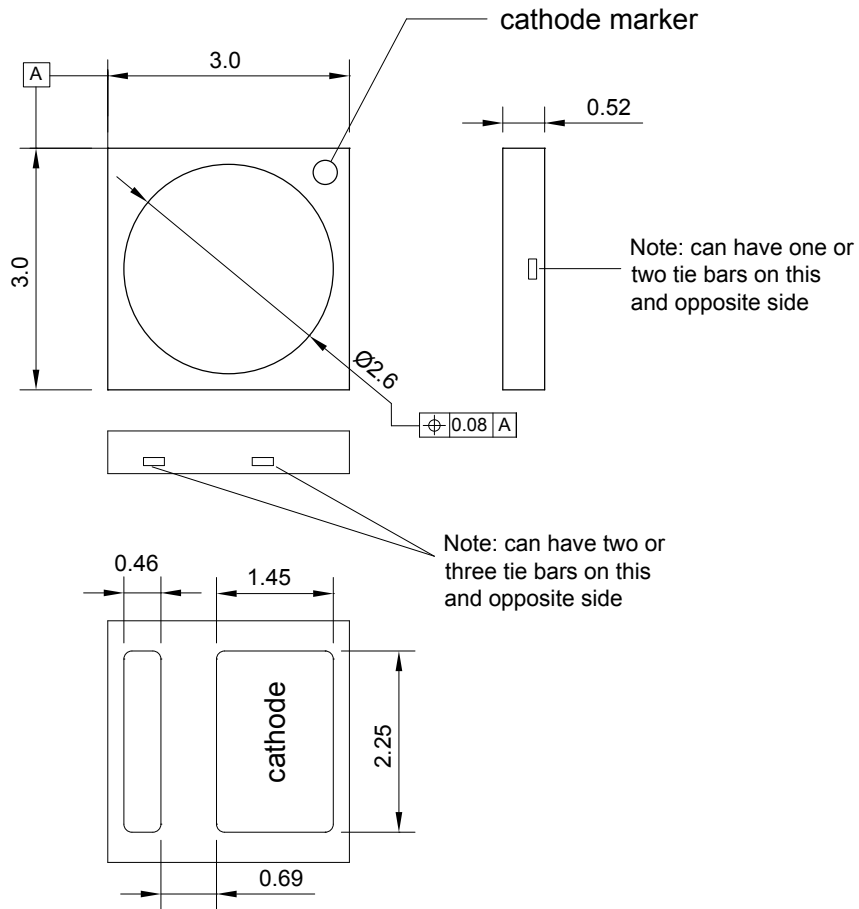

Figure 9. Mechanical dimensions for LUXEON 3030 HV.

Notes for Figure 9:

1. Drawings are not to scale.
2. All dimensions are in millimeters.
3. Tolerance: $\pm 0.10\text{mm}$.

Reflow Soldering Guidelines

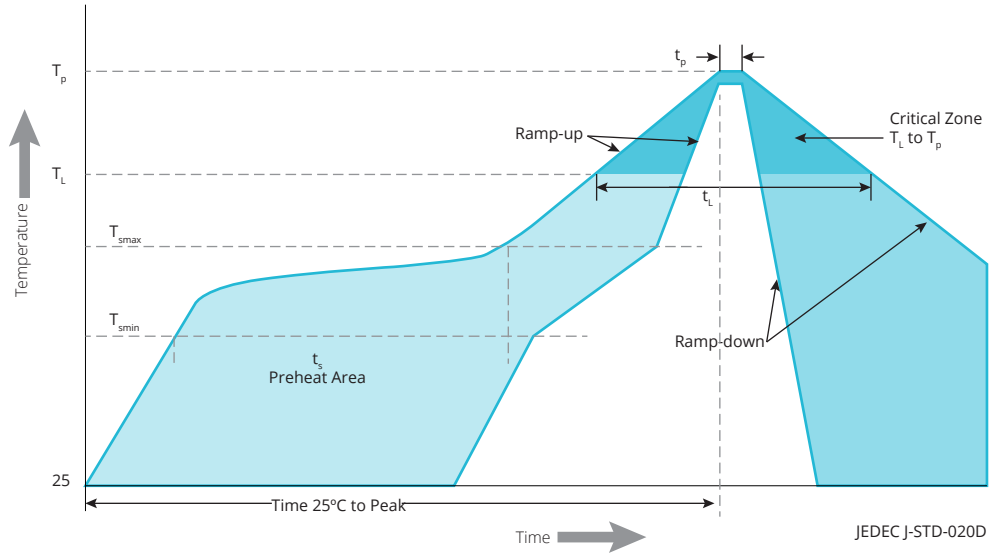

Figure 10. Visualization of the acceptable reflow temperature profile as specified in Table 8.

Table 8. Reflow profile characteristics for LUXEON 3030 HV.

PROFILE FEATURE	LEAD-FREE ASSEMBLY
Preheat Minimum Temperature (T_{smin})	150°C
Preheat Maximum Temperature (T_{smax})	200°C
Preheat Time (t_{smin} to t_{smax})	60 to 120 seconds
Ramp-Up Rate (T_{smax} to T_p)	3°C / second maximum
Liquidus Temperature (T_L)	217°C
Time Maintained Above Temperature T_L (t_t)	60 to 150 seconds
Peak / Classification Temperature (T_p)	260°C
Time Within 5°C of Actual Temperature (t_p)	20 to 40 seconds
Ramp-Down Rate	6°C / second maximum
Time 25°C to Peak Temperature	8 minutes maximum

JEDEC Moisture Sensitivity

Table 9. Moisture sensitivity levels for LUXEON 3030 HV.

LEVEL	FLOOR LIFE		SOAK REQUIREMENTS STANDARD	
	TIME	CONDITIONS	TIME	CONDITIONS
3	168 Hours	30°C / 60% RH	192 Hours +5/-0	30°C / 60% RH

Solder Pad Design

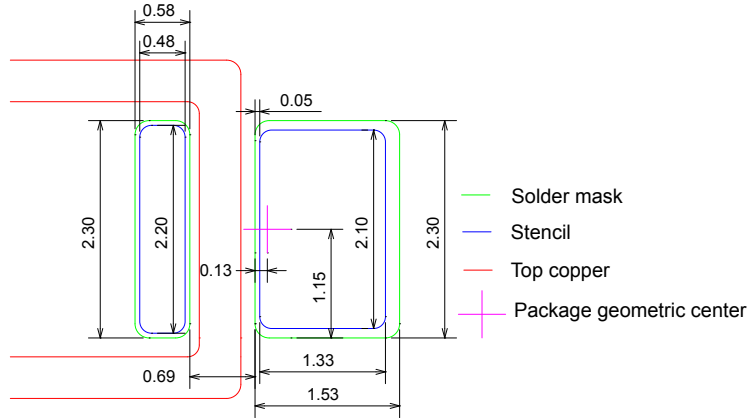

Figure 11. Recommended PCB solder pad layout for LUXEON 3030 HV.

Packaging Information

Pocket Tape Dimensions

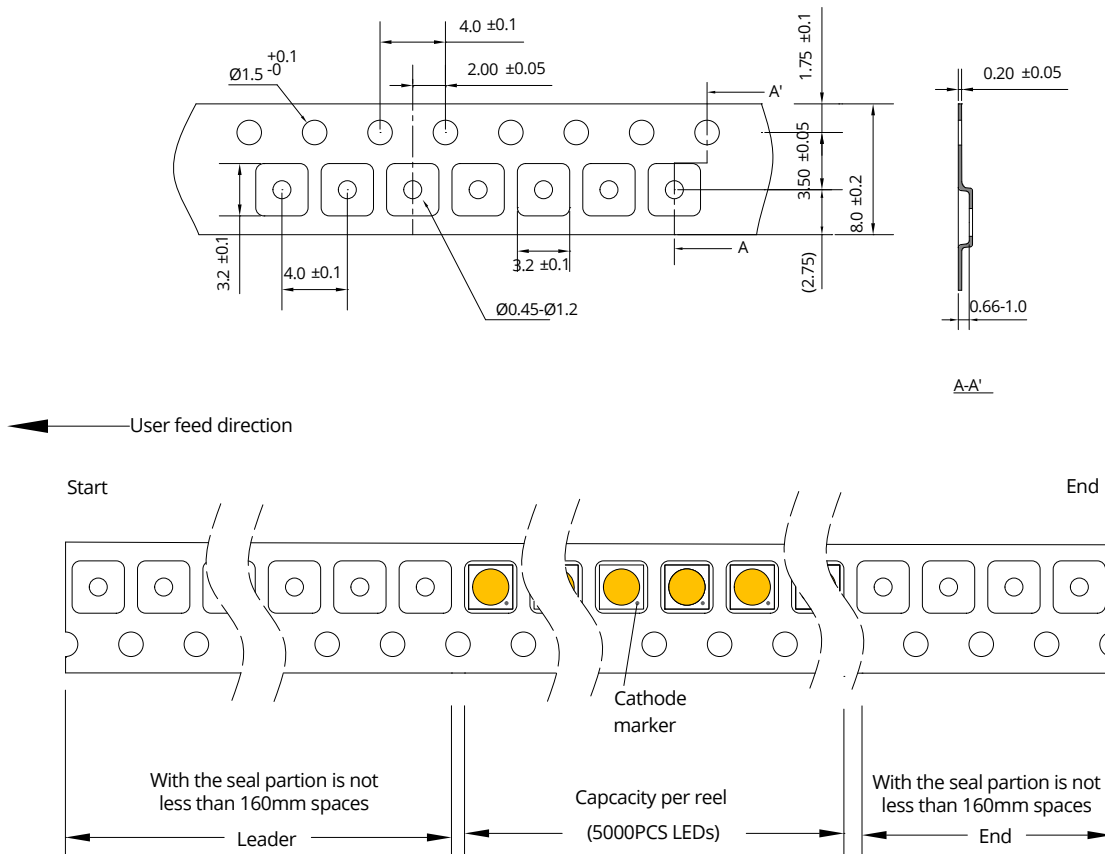

Figure 12. Pocket tape dimensions for LUXEON 3030 HV.

Notes for Figures 11 and 12:
 1. Drawings are not to scale.
 2. All dimensions are in millimeters.

Reel Dimensions

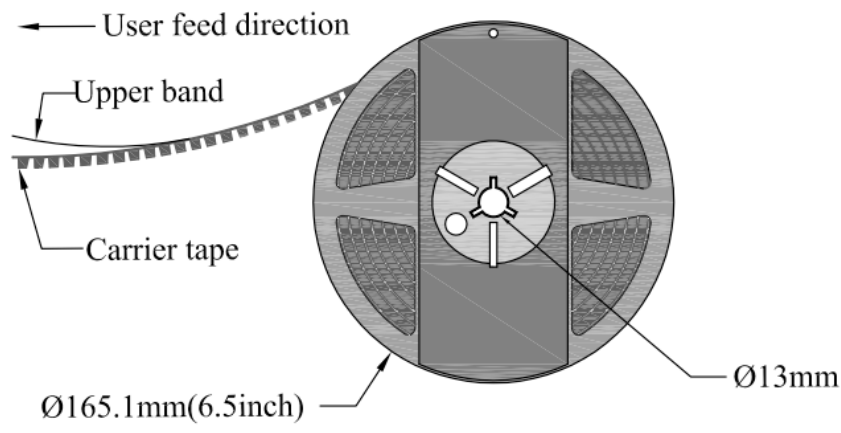

Figure 13. Reel dimensions for LUXEON 3030 HV.

- Notes for Figure 13:
- 1. Drawings are not to scale.
 - 2. All dimensions are in millimeters.

About Lumileds

Lumileds is the global leader in light engine technology. The company develops, manufactures and distributes groundbreaking LEDs and automotive lighting products that shatter the status quo and help customers gain and maintain a competitive edge.

With a rich history of industry “firsts,” Lumileds is uniquely positioned to deliver lighting advancements well into the future by maintaining an unwavering focus on quality, innovation and reliability.

To learn more about our portfolio of light engines, visit lumileds.com.



©2017 Lumileds Holding B.V. All rights reserved.
LUXEON is a registered trademark of the Lumileds Holding B.V.
in the United States and other countries.

lumileds.com

Neither Lumileds Holding B.V. nor its affiliates shall be liable for any kind of loss of data or any other damages, direct, indirect or consequential, resulting from the use of the provided information and data. Although Lumileds Holding B.V. and/or its affiliates have attempted to provide the most accurate information and data, the materials and services information and data are provided “as is,” and neither Lumileds Holding B.V. nor its affiliates warrants or guarantees the contents and correctness of the provided information and data. Lumileds Holding B.V. and its affiliates reserve the right to make changes without notice. You as user agree to this disclaimer and user agreement with the download or use of the provided materials, information and data.