



Chipsmall Limited consists of a professional team with an average of over 10 year of expertise in the distribution of electronic components. Based in Hongkong, we have already established firm and mutual-benefit business relationships with customers from,Europe,America and south Asia,supplying obsolete and hard-to-find components to meet their specific needs.

With the principle of “Quality Parts,Customers Priority,Honest Operation,and Considerate Service”,our business mainly focus on the distribution of electronic components. Line cards we deal with include Microchip,ALPS,ROHM,Xilinx,Pulse,ON,Everlight and Freescale. Main products comprise IC,Modules,Potentiometer,IC Socket,Relay,Connector.Our parts cover such applications as commercial,industrial, and automotives areas.

We are looking forward to setting up business relationship with you and hope to provide you with the best service and solution. Let us make a better world for our industry!



Contact us

Tel: +86-755-8981 8866 Fax: +86-755-8427 6832

Email & Skype: info@chipsmall.com Web: www.chipsmall.com

Address: A1208, Overseas Decoration Building, #122 Zhenhua RD., Futian, Shenzhen, China



Power TOPLED® Enhanced thin film LED

LA E67F



Vorläufige Daten / Preliminary Data

Besondere Merkmale

- **Gehäusetypp:** weißes P-LCC-4 Gehäuse, farbloser klarer Verguss
- **Besonderheit des Bauteils:** mehr Licht durch erhöhten optischen Wirkungsgrad
- **Wellenlänge:** 617 nm (amber)
- **Abstrahlwinkel:** Lambertischer Strahler (120°)
- **Technologie:** InGaAIP
- **optischer Wirkungsgrad:** 43 lm/W
- **Gruppierungsparameter:** Lichtstärke, Durchflussspannung, Wellenlänge
- **Verarbeitungsmethode:** für alle SMT-Bestücktechniken geeignet
- **Lötmethode:** IR Reflow Löten und Wellenlöten (TTW)
- **Vorbehandlung:** nach JEDEC Level 2
- **Gurtung:** 8 mm Gurt mit 2000/Rolle, ø180 mm oder 8000/Rolle, ø330 mm
- **ESD-Festigkeit:** ESD-sicher bis 2 kV nach JESD22-A114-B

Anwendungen

- Ampelanwendung
- Hinterleuchtung (LCD, Schalter, Tasten, Displays, Werbebeleuchtung)
- Innen- und Außenbeleuchtung im Automobilbereich (z.B. Instrumentenbeleuchtung und Bremslichter)
- Ersatz von Kleinst-Glühlampen
- Markierungsbeleuchtung (z.B. Stufen, Fluchtwege, u.ä.)
- Signal- und Symbolleuchten

Features

- **package:** white P-LCC-4 package, colorless clear resin
- **feature of the device:** more light due to higher optical efficiency
- **wavelength:** 617 nm (amber)
- **viewing angle:** Lambertian Emitter (120°)
- **technology:** InGaAIP
- **optical efficiency:** 43 lm/W
- **grouping parameter:** luminous intensity, forward voltage, wavelength
- **assembly methods:** suitable for all SMT assembly methods
- **soldering methods:** IR reflow soldering and TTW soldering
- **preconditioning:** acc. to JEDEC Level 2
- **taping:** 8 mm tape with 2000/reel, ø180 mm or 8000/reel, ø330 mm
- **ESD-withstand voltage:** up to 2 acc. to JESD22-A114-B

Applications

- traffic lights
- backlighting (LCD, switches, keys, displays, illuminated advertising)
- interior and exterior automotive lighting (e.g. dashboard backlighting and brake lights)
- substitution of micro incandescent lamps
- marker lights (e.g. steps, exit ways, etc.)
- signal and symbol luminaire

Bestellinformation
Ordering Information

Typ	Emissions- farbe	Lichtstärke ¹⁾	Lichtstrom ²⁾	Bestellnummer
Type	Color of Emission	Luminous Intensity ¹⁾ $I_F = 50 \text{ mA}$ $I_V \text{ (mcd)}$	Luminous Flux ²⁾ $I_F = 50 \text{ mA}$ $\Phi_V \text{ (mlm)}$	Ordering Code
LA E67F-AABA-24-1	amber	1120 ...2240	5000 (typ.)	Q65110A0606

Anm.: -24-1 gesamter Farbbereich, Lieferung in Einzelgruppen (siehe **Seite 5**)
 -24-1 gesamter Durchlassspannungsbereich, Lieferung in Einzelgruppen (siehe **Seite 5**)

Dimmverhältnis im Gleichstrom-Betrieb max. 5:1

Note: -24-1 Total color tolerance range, delivery in single groups (please see **page 5**)
 -24-1 Total forward voltage tolerance, delivery in single groups (see **page 5**)

Dimming range for direct current mode max. 5:1

Grenzwerte
Maximum Ratings

Bezeichnung Parameter	Symbol Symbol	Wert Value	Einheit Unit
Betriebstemperatur Operating temperature range	T_{op}	- 40 ... + 100	°C
Lagertemperatur Storage temperature range	T_{stg}	- 40 ... + 100	°C
Sperrschichttemperatur Junction temperature	T_j	+ 125	°C
Durchlassstrom Forward current ($T_A=25^\circ\text{C}$)	I_F	70	mA
Stoßstrom Surge current $t \leq 10 \mu\text{s}$, $D = 0.1$, $T_A=25^\circ\text{C}$	I_{FM}	0.1	A
Sperrspannung Reverse voltage ($T_A=25^\circ\text{C}$)	V_R	12	V
Leistungsaufnahme Power consumption ($T_A=25^\circ\text{C}$)	P_{tot}	190	mW
Wärmewiderstand Thermal resistance Sperrschicht/Umgebung ³⁾ Junction/ambient ³⁾	$R_{th JA}$	300	K/W
Sperrschicht/Löt看垫 Junction/soldering point	$R_{th JS}$	130	K/W

Kennwerte ($T_A = 25\text{ °C}$)

Characteristics

Bezeichnung Parameter	Symbol Symbol	Wert Value	Einheit Unit
Wellenlänge des emittierten Lichtes (typ.) Wavelength at peak emission $I_F = 50\text{ mA}$	λ_{peak}	624	nm
Dominantwellenlänge ⁴⁾ Dominant wavelength ⁴⁾ $I_F = 50\text{ mA}$	λ_{dom}	617* -5/+7	nm
Spektrale Bandbreite bei 50 % $I_{\text{rel max}}$ (typ.) Spectral bandwidth at 50 % $I_{\text{rel max}}$ $I_F = 50\text{ mA}$	$\Delta\lambda$	18	nm
Abstrahlwinkel bei 50 % I_V (Vollwinkel) (typ.) Viewing angle at 50 % I_V	2ϕ	120	Grad deg.
Durchlassspannung ⁵⁾ (min.) Forward voltage ⁵⁾ (typ.) $I_F = 50\text{ mA}$ (max.)	V_F V_F V_F	2.05* 2.30 2.65	V V V
Sperrstrom (typ.) Reverse current (max.) $V_R = 12\text{ V}$	I_R I_R	0.2 10	μA μA
Temperaturkoeffizient von λ_{peak} (typ.) Temperature coefficient of λ_{peak} $I_F = 50\text{ mA}; -10\text{ °C} \leq T \leq 100\text{ °C}$	$TC_{\lambda_{\text{peak}}}$	0.14	nm/K
Temperaturkoeffizient von λ_{dom} (typ.) Temperature coefficient of λ_{dom} $I_F = 50\text{ mA}; -10\text{ °C} \leq T \leq 100\text{ °C}$	$TC_{\lambda_{\text{dom}}}$	0.07	nm/K
Temperaturkoeffizient von V_F (typ.) Temperature coefficient of V_F $I_F = 50\text{ mA}; -10\text{ °C} \leq T \leq 100\text{ °C}$	TC_V	- 4.7	mV/K
Optischer Wirkungsgrad (typ.) Optical efficiency $I_F = 50\text{ mA}$	η_{opt}	43	lm/W

* Einzelgruppen siehe Seite 5
Individual groups on page 5

Wellenlängengruppen (Dominantwellenlänge)⁴⁾
Wavelength Groups (Dominant Wavelength)⁴⁾

Gruppe Group	Wellenlänge Wavelength		Einheit Unit
	min.	max.	
2	612	616	nm
3	616	620	nm
4	620	624	nm

Durchlassspannungsgruppen⁵⁾
Forward Voltage Groups⁵⁾

Gruppe Group	Durchlassspannung Forward voltage		Einheit Unit
	min.	max.	
3B	2.05	2.20	V
4A	2.20	2.35	V
4B	2.35	2.50	V
5A	2.50	2.65	V

Helligkeits-Gruppierungsschema
Luminous Intensity Groups

Lichtgruppe Luminous Intensity Group	Lichtstärke ¹⁾ Luminous Intensity ¹⁾ I_V (mcd)	Lichtstrom ²⁾ Luminous Flux ²⁾ Φ_V (lm)
AA	1120 ... 1400	3700 (typ.)
AB	1400 ... 1800	4800 (typ.)
BA	1800 ... 2240	6000 (typ.)

Anm.: Die Standardlieferform von Serientypen beinhaltet eine Familiengruppe. Diese besteht aus 3 Helligkeitshalbgruppen. Einzelne Helligkeitshalbgruppen sind nicht bestellbar.

Note: The standard shipping format for serial types includes a family group of 3 individual brightness half groups. Individual brightness half groups cannot be ordered.

Gruppenbezeichnung auf Etikett
Group Name on Label

Beispiel: AB-3-4A

Example: AB-3-4A

Lichtgruppe Luminous Intensity Group	Halbgruppe Half Group	Wellenlänge Wavelength	Durchlassspannung Forward Voltage
A	B	3	4A

Anm.: In einer Verpackungseinheit / Gurt ist immer nur eine Gruppe für jede Selektion enthalten.

Note: No packing unit / tape ever contains more than one group for each selection.

Relative spektrale Emission²⁾

Relative Spectral Emission²⁾

$V(\lambda)$ = spektrale Augenempfindlichkeit / Standard eye response curve

$I_{rel} = f(\lambda)$, $T_A = 25\text{ °C}$, $I_F = 50\text{ mA}$

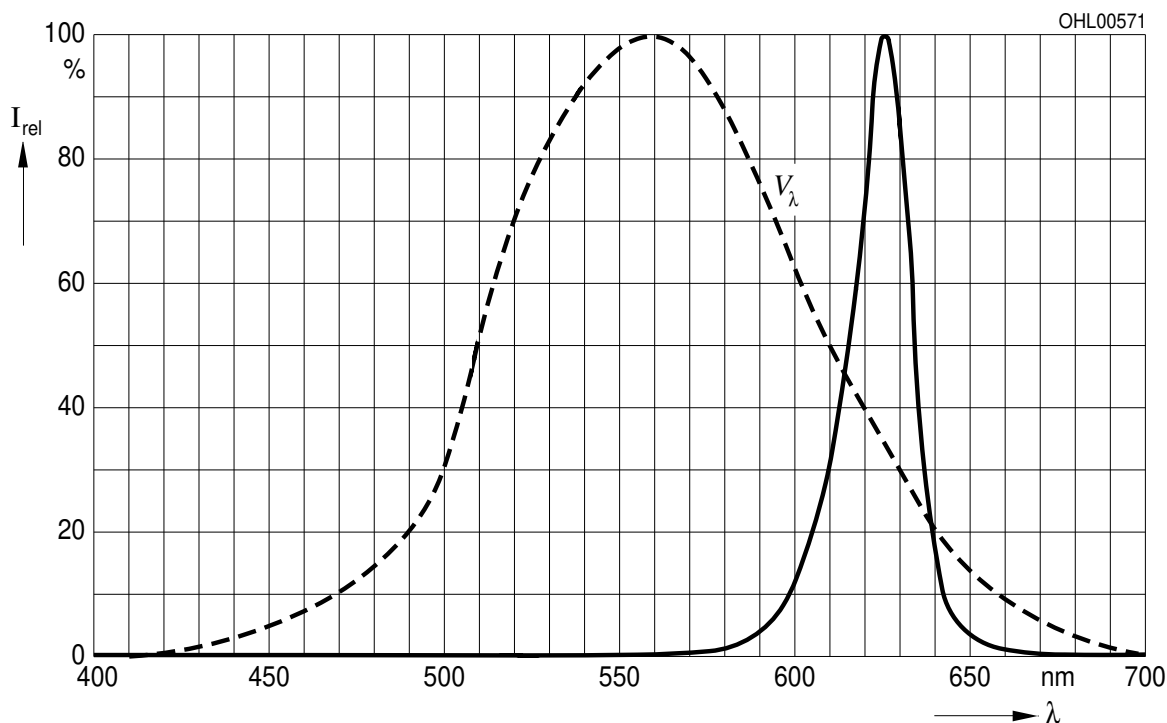

Abstrahlcharakteristik²⁾

Radiation Characteristic²⁾

$I_{rel} = f(\varphi)$; $T_A = 25\text{ °C}$

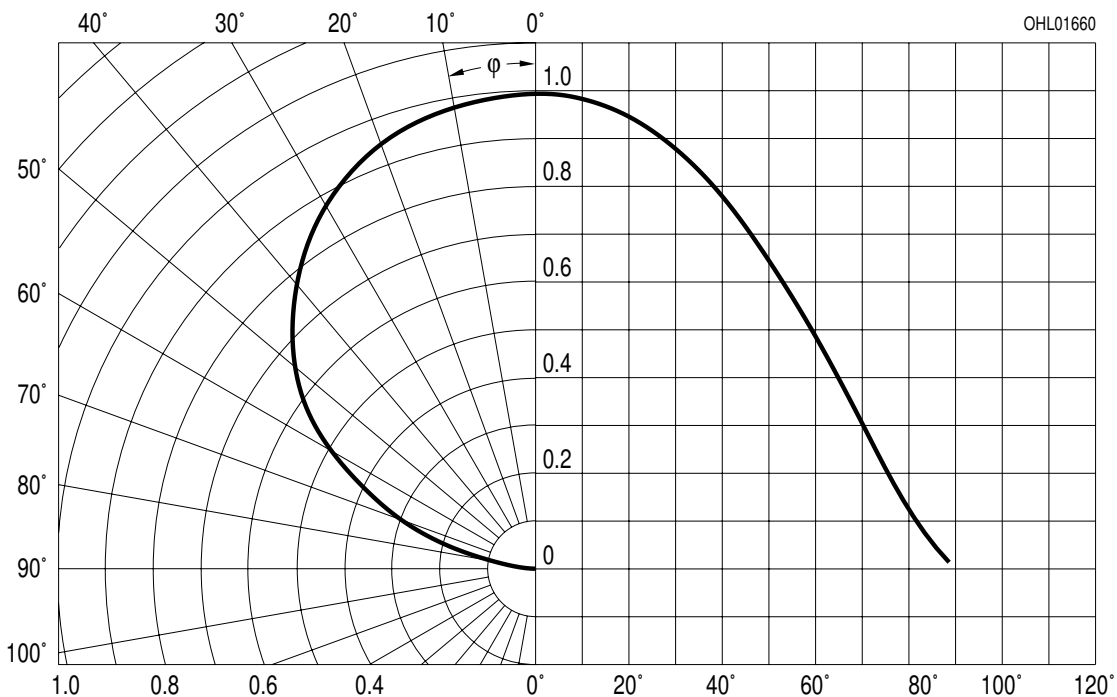

Durchlassstrom²⁾
Forward Current²⁾

$I_F = f(V_F); T_A = 25\text{ °C}$

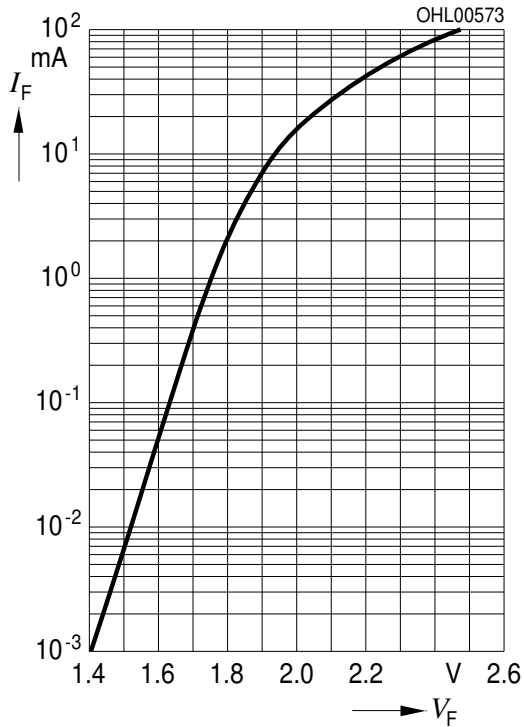

Relative Lichtstärke²⁾
Relative Luminous Intensity²⁾

$I_V/I_{V(50\text{ mA})} = f(I_F); T_A = 25\text{ °C}$

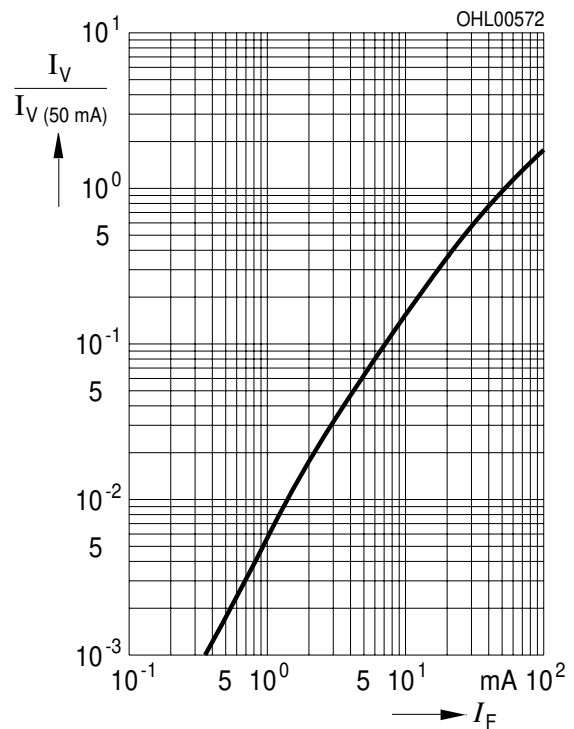

Relative Lichtstärke²⁾
Relative Luminous Intensity²⁾

$I_V/I_{V(25\text{ °C})} = f(T_A); I_F = 50\text{ mA}$

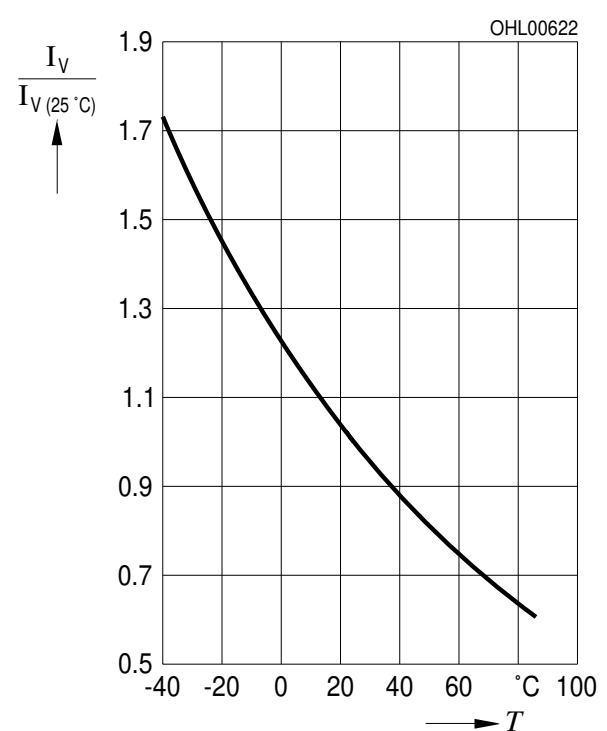

Maximal zulässiger Durchlassstrom
Max. Permissible Forward Current

$I_F = f(T)$

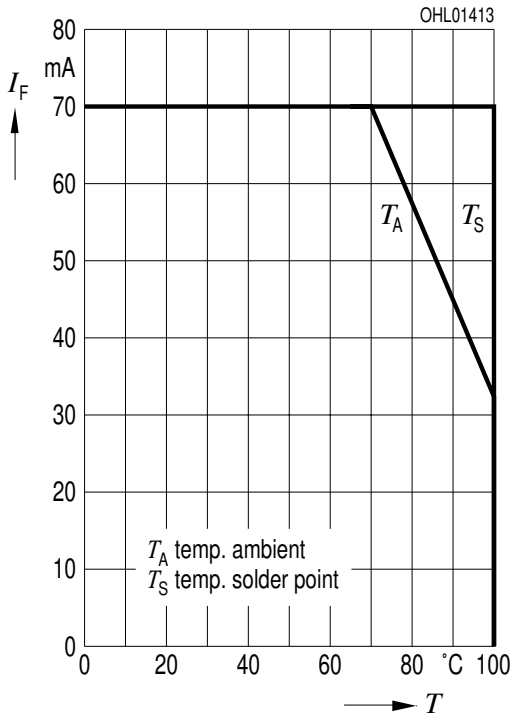

Zulässige Impulsbelastbarkeit $I_F = f(t_p)$
Permissible Pulse Handling Capability
 Duty cycle $D =$ parameter, $T_A = 25\text{ °C}$

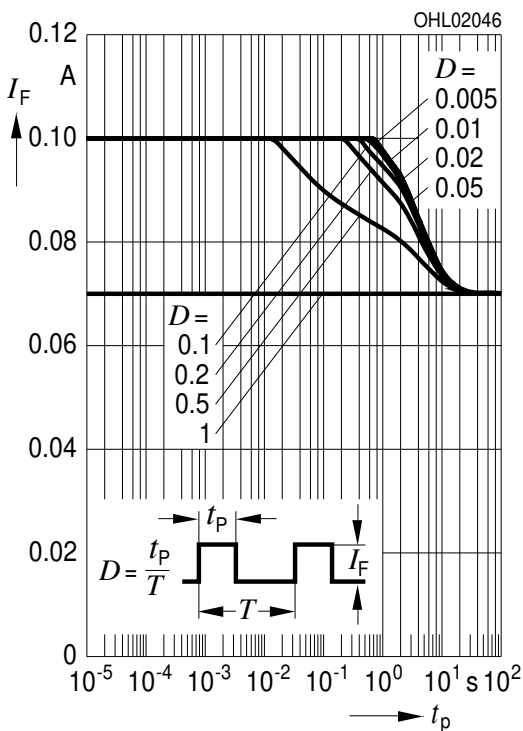

Zulässige Impulsbelastbarkeit $I_F = f(t_p)$
Permissible Pulse Handling Capability
 Duty cycle $D =$ parameter, $T_A = 85\text{ °C}$

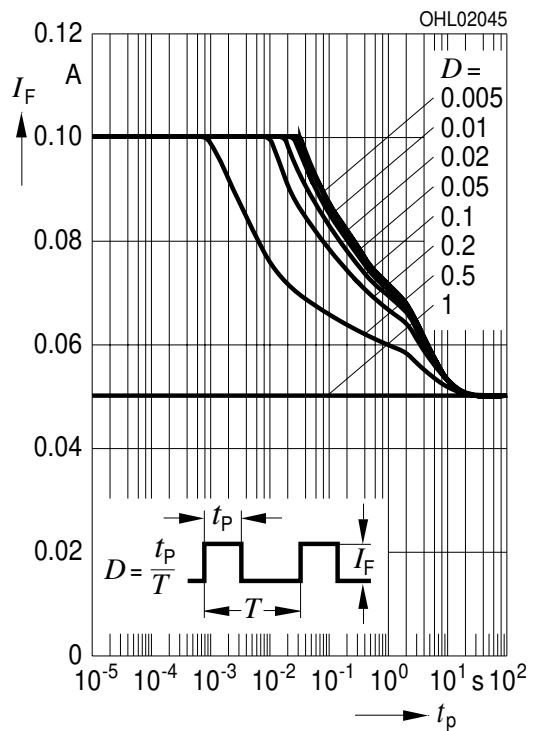

Maßzeichnung⁶⁾
 Package Outlines⁶⁾

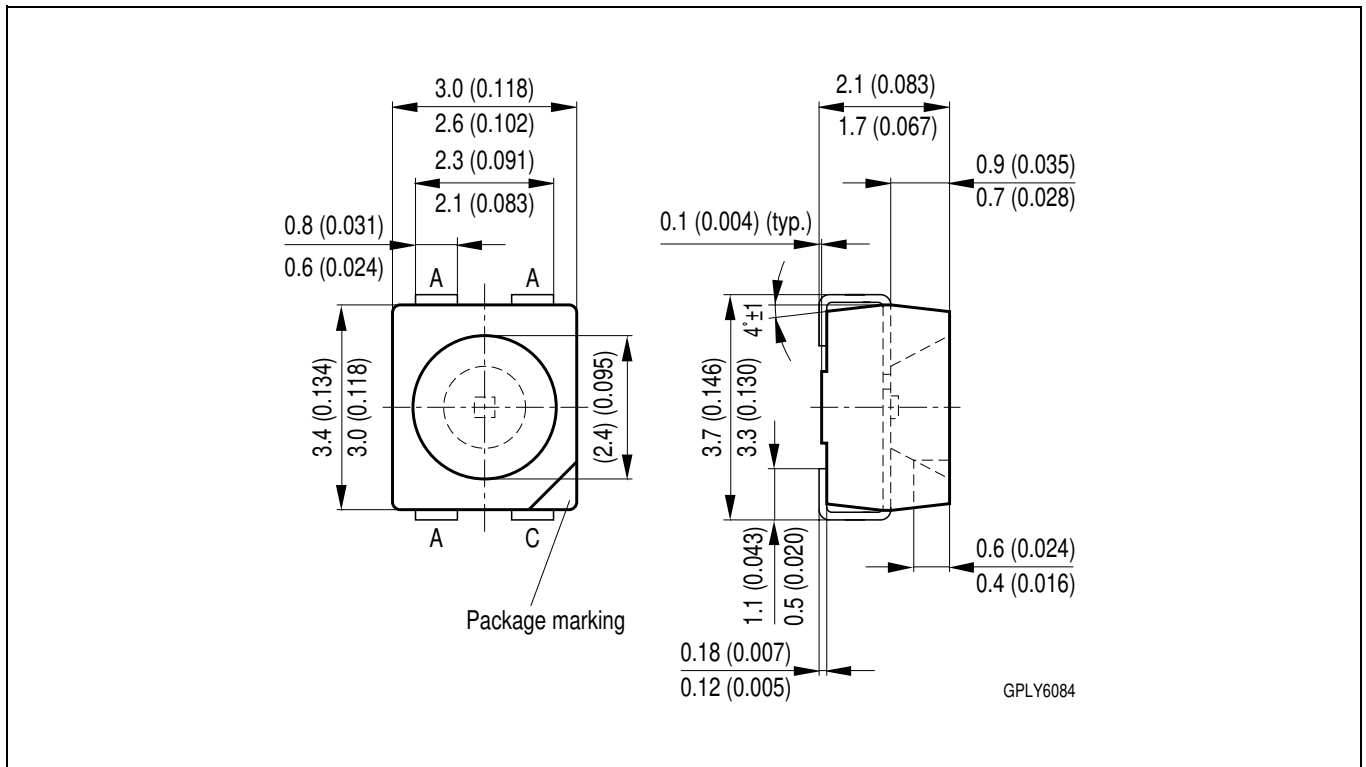

Gewicht / Approx. weight: 35 mg

Gurtung / Polarität und Lage⁶⁾

Method of Taping / Polarity and Orientation⁶⁾

Verpackungseinheit 2000/Rolle, ø180 mm
 oder 8000/Rolle, ø330 mm
 Packing unit 2000/reel, ø180 mm
 or 8000/reel, ø330 mm

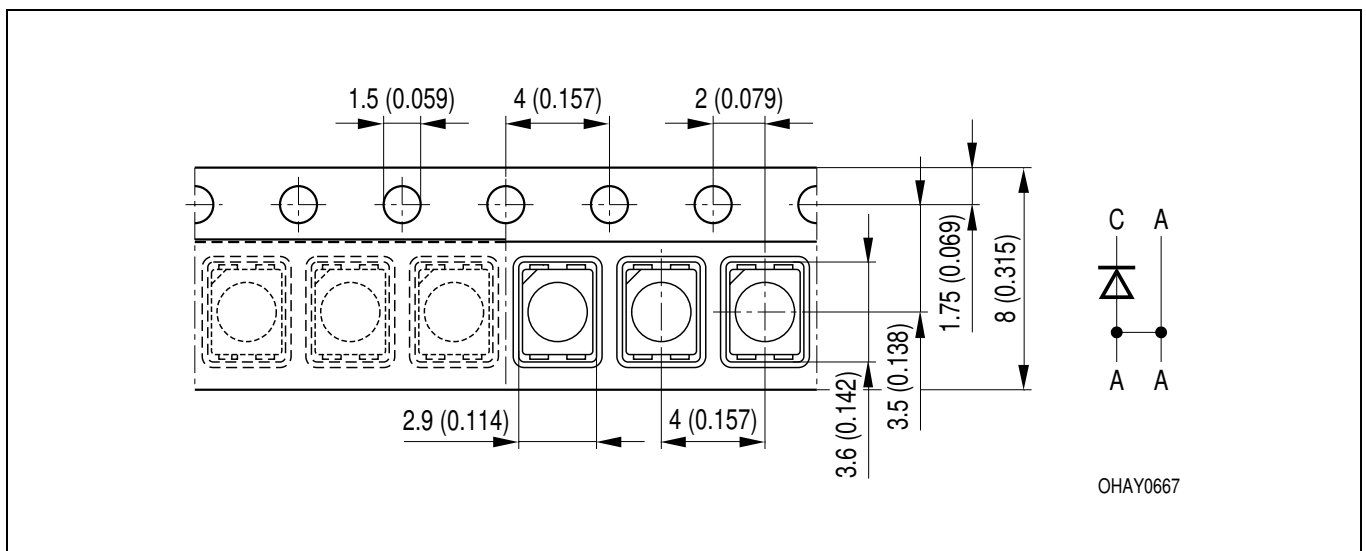

Empfohlenes Lötpadding⁶⁾ verwendbar für TOPLED[®] und Power TOPLED[®]
 IR Reflow Lötten
Recommended Solder Pad⁶⁾ useable for TOPLED[®] and Power TOPLED[®]
 IR Reflow Soldering

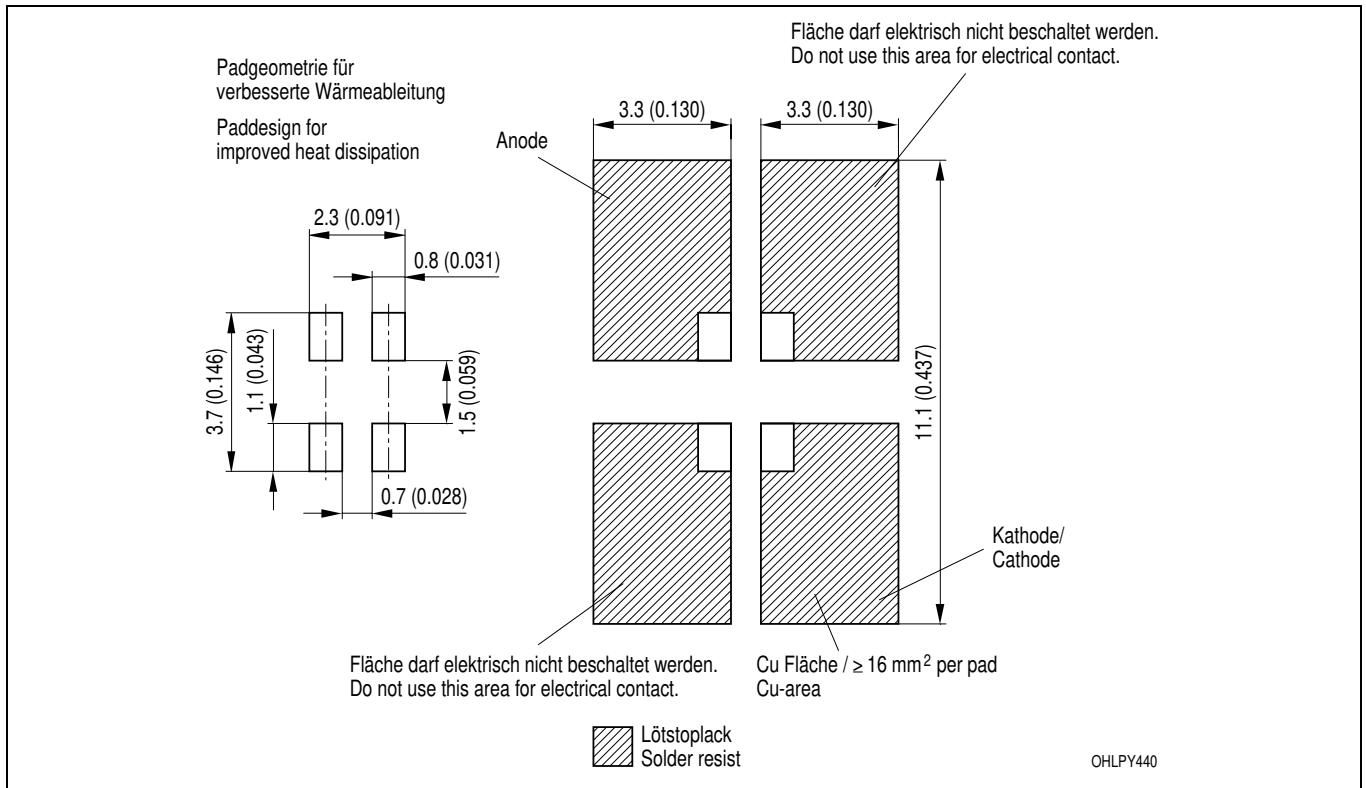

Empfohlenes Lötpadding⁶⁾ Wellenlötten (TTW)
Recommended Solder Pad⁶⁾ TTW Soldering

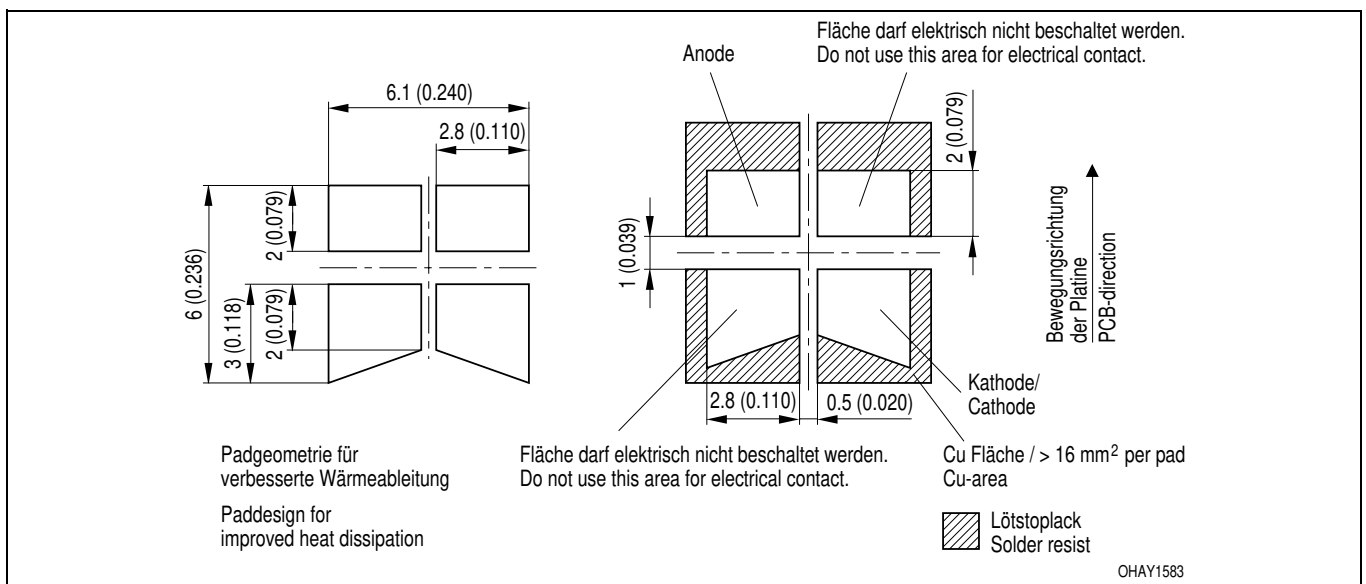

Lötbedingungen
Soldering Conditions

Vorbehandlung nach JEDEC Level 2
Preconditioning acc. to JEDEC Level 2

IR-Reflow Lötprofil
IR Reflow Soldering Profile

(nach IPC 9501)
(acc. to IPC 9501)

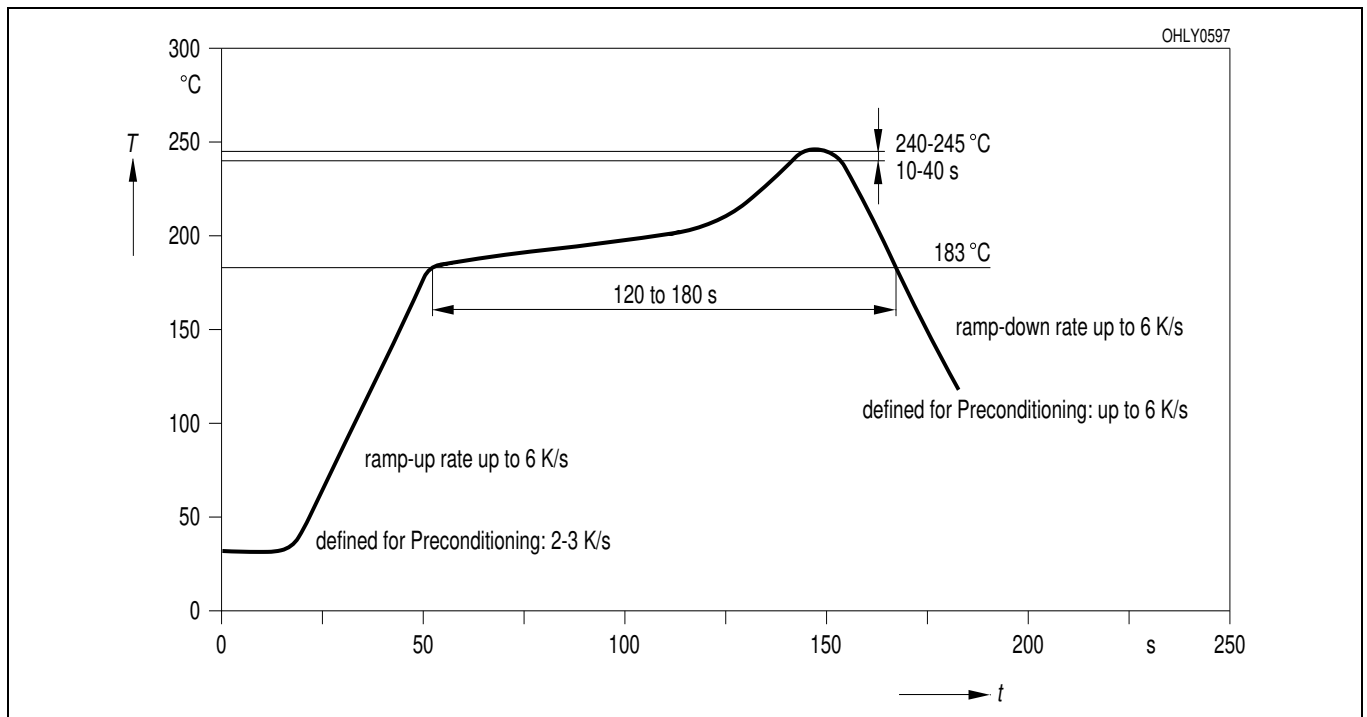

Wellenlöten (TTW)
TTW Soldering

(nach CECC 00802)
(acc. to CECC 00802)

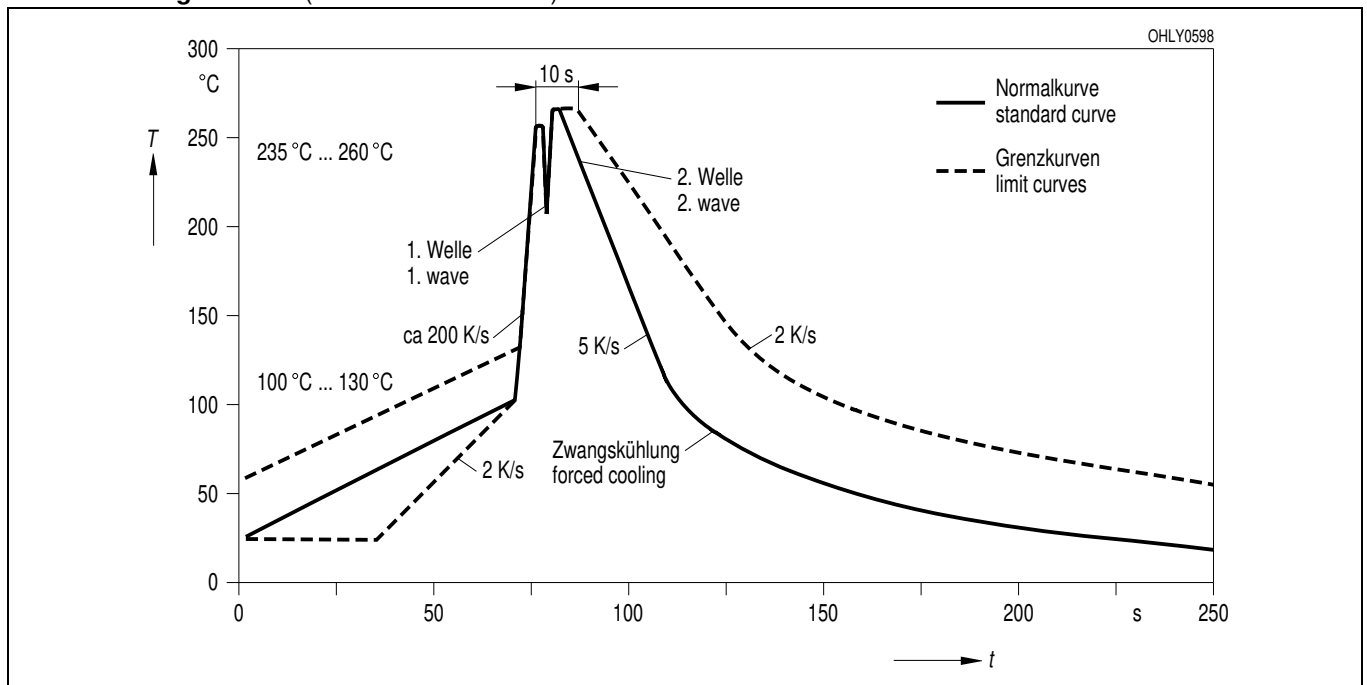

Revision History: 2003-09-24

Previous Version: 2003-09-23

Page	Subjects (major changes since last revision)	Date of change
4	set reverse current from 0.01 and 10 to t.b.d.	
14	annotations	2002-07-23
2	ordering code	2002-11-04
13	new recommended solder pad	2003-05-26
1	ESD norm	2003-08-25
3	ambient temperature	2003-08-25
8	Permissible Pulse Handling Capability	2003-09-23
all	new template	2003-09-24

Published by OSRAM Opto Semiconductors GmbH

Wernerwerkstrasse 2, D-93049 Regensburg

www.osram-os.com

© All Rights Reserved.

Attention please!

The information describes the type of component and shall not be considered as assured characteristics.

All typical data and graphs are basing on representative samples, but don't represent the production range. If requested, e.g. because of technical improvements, these typ. data will be changed without any further notice.

Terms of delivery and rights to change design reserved. Due to technical requirements components may contain dangerous substances. For information on the types in question please contact our Sales Organization.

If printed or downloaded, please find the latest version in the Internet.

Packing

Please use the recycling operators known to you. We can also help you – get in touch with your nearest sales office. By agreement we will take packing material back, if it is sorted. You must bear the costs of transport. For packing material that is returned to us unsorted or which we are not obliged to accept, we shall have to invoice you for any costs incurred.

Components used in life-support devices or systems must be expressly authorized for such purpose! Critical components⁷⁾ may only be used in life-support devices or systems⁸⁾ with the express written approval of OSRAM OS.

Fußnoten:

- 1) Helligkeitswerte werden mit einer Stromeinprägedauer von 25 ms und einer Genauigkeit von $\pm 11\%$ ermittelt.
- 2) Wegen der besonderen Prozessbedingungen bei der Herstellung von LED können typische oder abgeleitete technische Parameter nur aufgrund statistischer Werte wiedergegeben werden. Diese stimmen nicht notwendigerweise mit den Werten jedes einzelnen Produktes überein, dessen Werte sich von typischen und abgeleiteten Werten oder typischen Kennlinien unterscheiden können.
- 3) R_{thJA} ergibt sich bei Montage auf PC-Board FR 4 (Padgröße $\geq 16 \text{ mm}^2$ je Pad)
- 4) Wellenlängen werden mit einer Stromeinprägedauer von 25 ms und einer Genauigkeit von $\pm 1 \text{ nm}$ ermittelt.
- 5) Spannungswerte werden mit einer Stromeinprägedauer von 1 ms und einer Genauigkeit von $\pm 0,05 \text{ V}$ ermittelt.
- 6) Maße werden wie folgt angegeben: mm (inch)
- 7) Ein kritisches Bauteil ist ein Bauteil, das in lebenserhaltenden Apparaten oder Systemen eingesetzt wird und dessen Defekt voraussichtlich zu einer Fehlfunktion dieses lebenserhaltenden Apparates oder Systems führen wird oder die Sicherheit oder Effektivität dieses Apparates oder Systems beeinträchtigt.
- 8) Lebenserhaltende Apparate oder Systeme sind für (a) die Implantierung in den menschlichen Körper oder (b) für die Lebenserhaltung bestimmt. Falls sie versagen, kann davon ausgegangen werden, dass die Gesundheit des Patienten in Gefahr ist.

Remarks:

- 1) Brightness groups are tested at a current pulse duration of 25 ms and a tolerance of $\pm 11\%$.
- 2) Due to the special conditions of the manufacturing processes of LED, the typical data or calculated correlations of technical parameters can only reflect statistical figures. These do not necessarily correspond to the actual parameters of each single product, which could differ from the typical data and calculated correlations or the typical characteristic line.
- 3) R_{thJA} results from mounting on PC board FR 4 (pad size $\geq 16 \text{ mm}^2$ per pad)
- 4) Wavelengths are tested at a current pulse duration of 25 ms and a tolerance of $\pm 1 \text{ nm}$.
- 5) Forward voltages are tested at a current pulse duration of 1 ms and a tolerance of $\pm 0.05 \text{ V}$.
- 6) Dimensions are specified as follows: mm (inch)
- 7) A critical component is a component used in a life-support device or system whose failure can reasonably be expected to cause the failure of that life-support device or system, or to affect its safety or the effectiveness of that device or system.
- 8) Life support devices or systems are intended (a) to be implanted in the human body, or (b) to support and/or maintain and sustain human life. If they fail, it is reasonable to assume that the health of the user may be endangered.