



Chipsmall Limited consists of a professional team with an average of over 10 year of expertise in the distribution of electronic components. Based in Hongkong, we have already established firm and mutual-benefit business relationships with customers from,Europe,America and south Asia,supplying obsolete and hard-to-find components to meet their specific needs.

With the principle of "Quality Parts,Customers Priority,Honest Operation,and Considerate Service",our business mainly focus on the distribution of electronic components. Line cards we deal with include Microchip,ALPS,ROHM,Xilinx,Pulse,ON,Everlight and Freescale. Main products comprise IC,Modules,Potentiometer,IC Socket,Relay,Connector.Our parts cover such applications as commercial,industrial, and automotives areas.

We are looking forward to setting up business relationship with you and hope to provide you with the best service and solution. Let us make a better world for our industry!



## Contact us

Tel: +86-755-8981 8866 Fax: +86-755-8427 6832

Email & Skype: info@chipsmall.com Web: www.chipsmall.com

Address: A1208, Overseas Decoration Building, #122 Zhenhua RD., Futian, Shenzhen, China





# SERIES LA SWITCHES

## PUSHBUTTON SWITCHES - SEALED ILLUMINATED



### SPECIFICATIONS

Contact Rating:	5A @ 250 VAC 8A @ 125 VAC 2A @ 250 VDC 6A @ 24 VDC
Life Expectancy (Mechanical):	≥ 100,000 cycles
Life Expectancy (Electrical):	≥ 50,000 cycles
Contact Resistance:	100mΩ max. typical; initial @ 2-4 VDC
Insulation Resistance:	> 1,000MΩ
Dielectric Strength:	> 1,500 volts 1 minute > 3,000 volts between poles
Actuation Force:	300g / pole
Operating Temperature:	-20°C to 55°C
Degree of Protection:	IP65

### FEATURES & BENEFITS

- ▶ Modular interface/contact block design
- ▶ Robust product for industrial applications
- ▶ Attractive front panel design
- ▶ Illuminated options available

### APPLICATIONS/MARKETS

- ▶ Industrial controls
- ▶ Instrumentation
- ▶ Transportation
- ▶ Telecommunications

### MATERIALS

Switch Housing:	Polyetherimide (PEI)
Contact Housing:	Diallyl Phthalate (DAP)
Actuator Ring:	Polycarbonate (PC)
Lens:	Polycarbonate (PC)
Contacts:	Silver plated copper alloy
Terminals:	Silver plated copper alloy



### HOW TO ORDER

SERIES LA	TERMINATION	MECHANICAL CONFIGURATION	PUSHBUTTON HEAD	CIRCUIT	LAMP TYPE & VOLTAGE	LAMP COLOR (WHERE APPLICABLE)	LENS COLOR
	S = Solder Lug  K = Socket  P = Pilot Indicator	EE = Latching  OA = Momentary  PL* = Pilot Indicator  *For LAP (Pilot Indicator)	U1 = Ø29mm  V1 = Ø25mm  U3* = Ø29mm  V3* = Ø25mm  *Flush Mount	0* = Pilot Ind. 1** = SPDT 2 = DPDT 3 = 3PDT 4 = 4PDT  *For LAP (Pilot Indicator only)  **LAK available SPDT only	0 = None A B C F G  H J K  M N L D E	Red Grn	RED = Red GRN = Green BLU = Blue WHT = White ORG = Orange YEL = Yellow



### Example Ordering Number

LA-S-EE-U1-1-0-RED

Specifications subject to change without notice.

### LAMP TYPE & VOLTAGE OPTIONS

0	:	Without lamp
A	:	Incandescent 6 V AC/DC 200 mA
B	:	Incandescent 14 V AC/DC 80 mA
C	:	Incandescent 28 V AC/DC 40 mA
D	:	Incandescent 48 V AC/DC 25 mA
E	:	Incandescent 60 V AC/DC 20 mA
F	:	Neon 110 V AC green/red
G	:	Neon 220 V AC green/red

### LAMP TYPE & VOLTAGE OPTIONS

H	:	LED 6 V DC green/yellow/red
J	:	LED 12 V DC green/yellow/red
K	:	LED 24 V DC green/yellow/red
L	:	Incandescent 33 V AC/DC 35 mA
N	:	Incandescent 14 V AC/DC 40 mA
M	:	Incandescent 6 V AC/DC 40 mA

# SERIES LA SWITCHES

## PUSHBUTTON SWITCHES - SEALED ILLUMINATED

### TERMINATION & PUSHBUTTON HEAD OPTIONS

#### LAS

SOLDER LUG

U1 Ø29mm

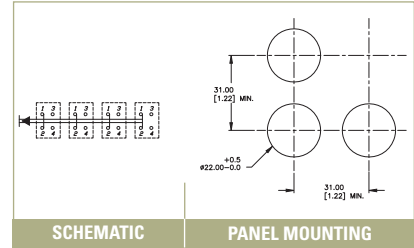
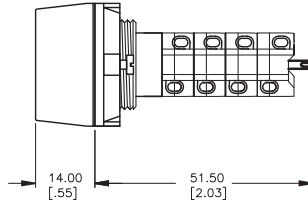
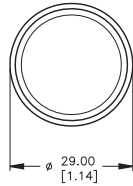

SCHEMATIC

PANEL MOUNTING

V1 Ø25mm

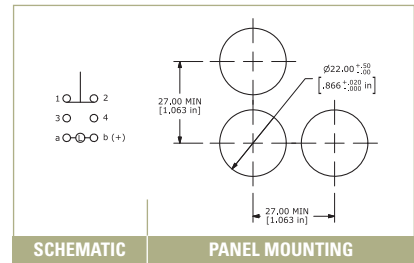
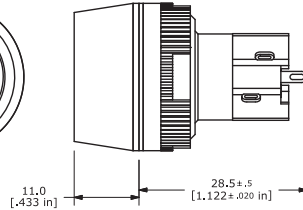
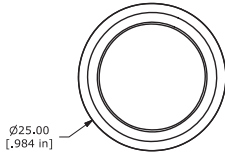

SCHEMATIC

PANEL MOUNTING

U3

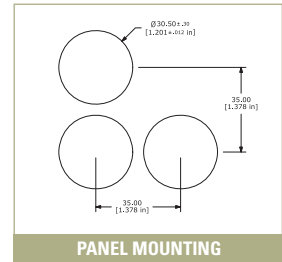
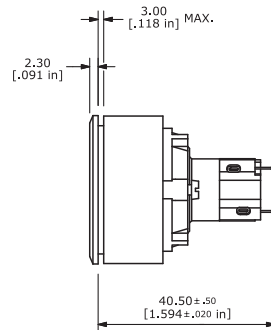
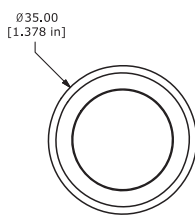

PANEL MOUNTING

V3

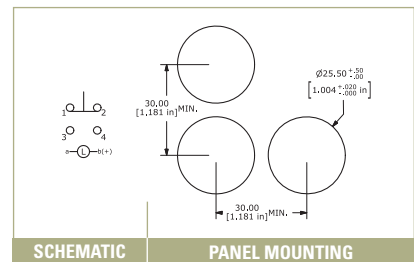
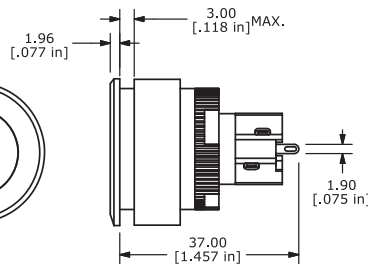
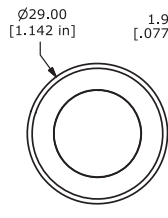

SCHEMATIC

PANEL MOUNTING



BOTTOM VIEW

	Mounting Length (A)
SPDT	29.0 mm
DPDT	36.5 mm
3PDT	44.0 mm
4PDT	51.5 mm

# TERMINATION & PUSHBUTTON HEAD OPTIONS

## LAK

SOCKET

**U1** Ø29mm

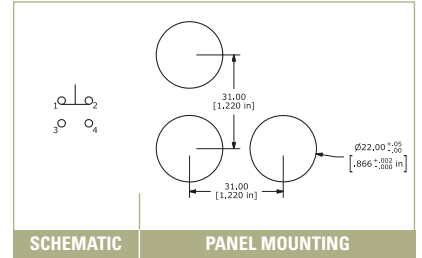
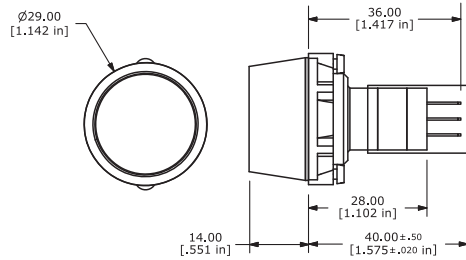

**V1** Ø25mm

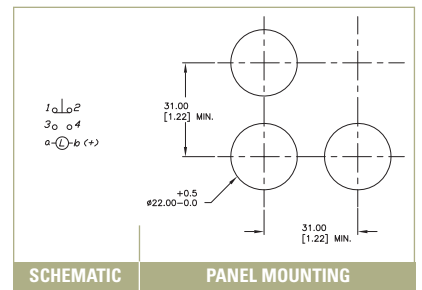
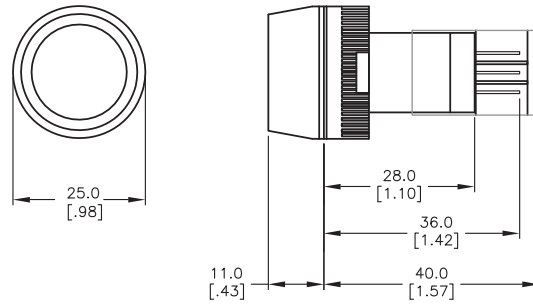

**U3**

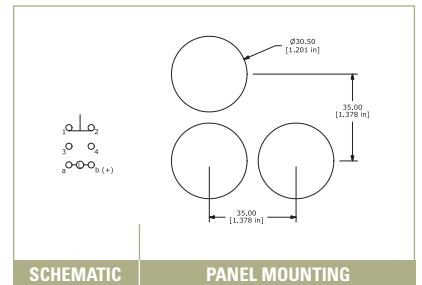
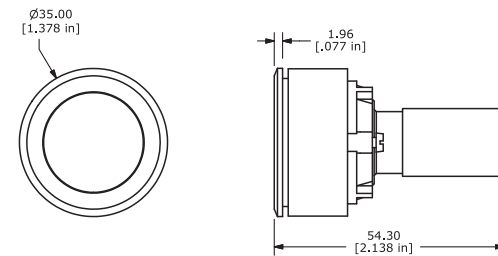

**V3**

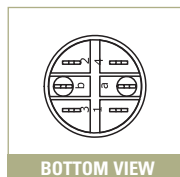
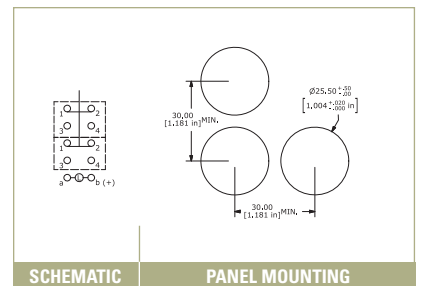
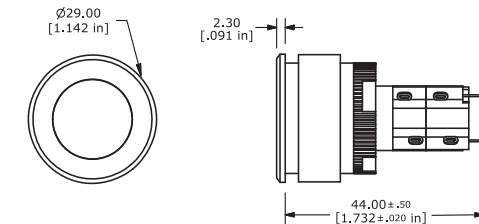

TACT SWITCHES  
NAVIGATION SWITCHES  
PUSHBUTTON SWITCHES  
TOGGLE SWITCHES  
ROCKER SWITCHES  
SLIDE SWITCHES  
SNAP-ACTION SWITCHES  
DIP SWITCHES  
KEYLOCK SWITCHES  
ROTARY SWITCHES  
DETECTOR SWITCHES  
CAP OPTIONS

# SERIES LA SWITCHES

## PUSHBUTTON SWITCHES - SEALED ILLUMINATED

### TERMINATION & PUSHBUTTON HEAD OPTIONS

#### LAP

PILOT INDICATOR

U1 Ø29mm

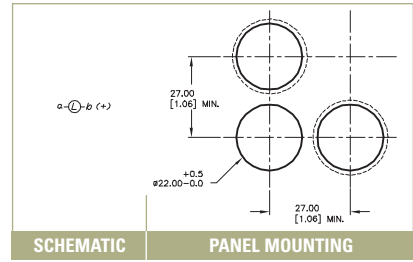
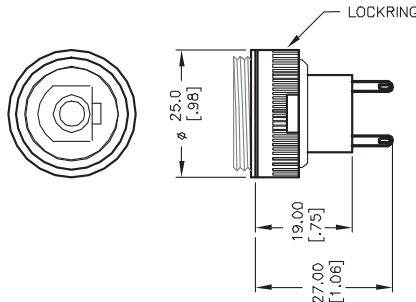

V1 Ø25mm

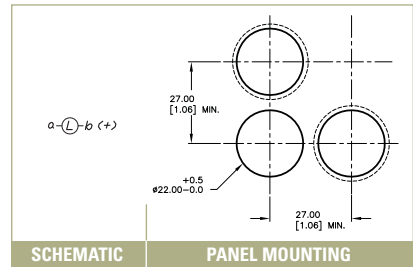
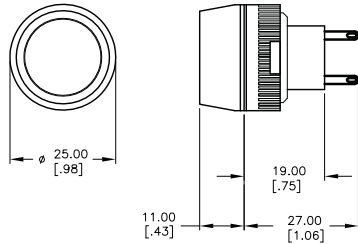

U3

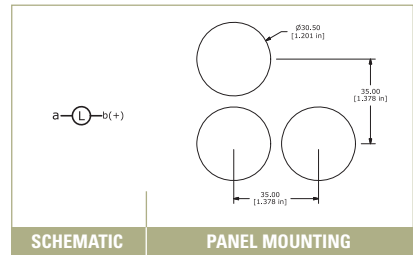
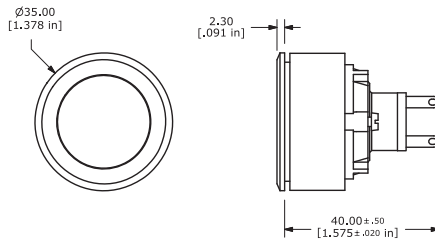

V3

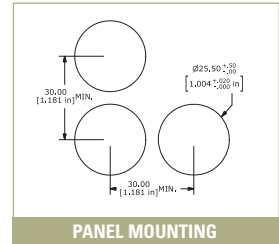
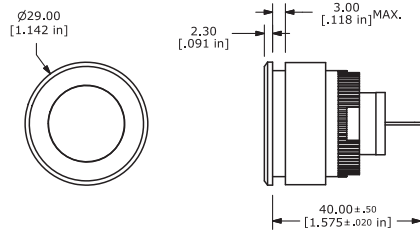

### MECHANICAL CONFIGURATION & CIRCUIT OPTIONS

#### 0 PILOT INDICATOR

Available LAS Pilot Indicator



SCHEMATIC

#### 1 SPDT

Available for LAK Socket Type and LAS Solder Lug

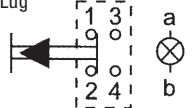

SCHEMATIC

#### 2 DPDT

Available for LAS Solder Lug



SCHEMATIC

#### 3 3PDT

Available for LAS Solder Lug

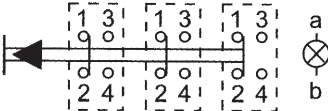

SCHEMATIC

#### 4 4PDT



SCHEMATIC

#### Mechanical Configuration Code

EE	Latching
OA	Momentary
PL	Pilot Indicator