



Chipsmall Limited consists of a professional team with an average of over 10 year of expertise in the distribution of electronic components. Based in Hongkong, we have already established firm and mutual-benefit business relationships with customers from,Europe,America and south Asia,supplying obsolete and hard-to-find components to meet their specific needs.

With the principle of “Quality Parts,Customers Priority,Honest Operation,and Considerate Service”,our business mainly focus on the distribution of electronic components. Line cards we deal with include Microchip,ALPS,ROHM,Xilinx,Pulse,ON,Everlight and Freescale. Main products comprise IC,Modules,Potentiometer,IC Socket,Relay,Connector.Our parts cover such applications as commercial,industrial, and automotives areas.

We are looking forward to setting up business relationship with you and hope to provide you with the best service and solution. Let us make a better world for our industry!



Contact us

Tel: +86-755-8981 8866 Fax: +86-755-8427 6832

Email & Skype: info@chipsmall.com Web: www.chipsmall.com

Address: A1208, Overseas Decoration Building, #122 Zhenhua RD., Futian, Shenzhen, China



LC/LW010- and LC/LW015-Series Power Modules: 18 Vdc to 36 Vdc or 36 Vdc to 75 Vdc Inputs, 10 W and 15 W



The LC/LW010- and LC/LW015-Series Power Modules use advanced, surface-mount technology and deliver high-quality, compact, dc-dc conversion at an economical price.

Options

- n Remote on-off
- n Choice of on/off configuration
- n Short pin: 2.8 mm \pm 0.25 mm (0.110 in. \pm 0.010 in.)
- n Synchronization (cannot be ordered on units with remote on/off)
- n Output voltage adjust: 90% to 110% of $V_{O, nom}$ (single outputs only)
- n Tight output voltage tolerance

Description

The L Single- and Dual-Output-Series Power Modules are low-profile, dc-dc converters that operate over an input voltage range of 18 Vdc to 36 Vdc or 36 Vdc to 75 Vdc and provide one or two precisely regulated outputs. The outputs are isolated from the input, allowing versatile polarity configurations and grounding connections. The modules have a maximum power rating of 10 W to 15 W and efficiencies of up to 84% for a 5 V output and 82% for a 3.3 V output. Built-in filtering for both input and output minimizes the need for external filtering.

Features

- n Low profile: 10.2 mm x 25.4 mm x 50.8 mm (0.4 in. x 1.0 in. x 2.0 in.) with standoffs (9.6 mm (0.38 in.) with standoffs recessed)
- n Wide input voltage range: 18 Vdc to 36 Vdc or 36 Vdc to 75 Vdc
- n Output current limiting, unlimited duration
- n Output overvoltage clamp
- n Undervoltage lockout
- n Input-to-output isolation: 1500 V
- n Operating case temperature range: -40°C to $+105^{\circ}\text{C}$
- n *UL** 1950 Recognized, CSA† 22.2 No. 950-95 Certified, IEC950, and VDE0805 Licensed
- n CE mark meets 73/23/EEC and 93/68/EEC directives‡
- n Within FCC and VDE Class A radiated limits

Applications

- n Telecommunications
- n Distributed power architectures
- n Private branch exchange (PBX)
- n Voice and data multiplexing

* *UL* is a registered trademark of Underwriters Laboratories, Inc.

† CSA is a registered trademark of Canadian Standards Association.

‡ This product is intended for integration into end-use equipment. All the required procedures for CE marking of end-use equipment should be followed. (The CE mark is placed on selected products.)

Absolute Maximum Ratings

Stresses in excess of the absolute maximum ratings can cause permanent damage to the device. These are absolute stress ratings only. Functional operation of the device is not implied at these or any other conditions in excess of those given in the operations sections of the data sheet. Exposure to absolute maximum ratings for extended periods can adversely affect device reliability.

Parameter	Device	Symbol	Min	Typ	Max	Unit
Input Voltage: Continuous	LC	V_I	0	—	50	Vdc
	LW	V_I	0	—	80	Vdc
	LW	$V_{I, trans}$	0	—	100	V
Transient (100 ms)	LW	$V_{I, trans}$	0	—	100	V
Operating Case Temperature (See Derating Curves, Figures 43—45.)	All	T_C	-40	—	105*	°C
Storage Temperature	All	T_{stg}	-55	—	125	°C
I/O Isolation	All	—	—	—	1500	Vdc

* Maximum case temperature varies based on power dissipation. See derating curves, Figures 43—45, for details.

Electrical Specifications

Table 1. Input Specifications

Parameter	Device	Symbol	Min	Typ	Max	Unit
Operating Input Voltage	LC	V_I	18	24	36	Vdc
	LW	V_I	36	48	75	Vdc
Maximum Input Current ($V_I = 0$ to $V_{I, max}$; $I_O = I_{O, max}$; see Figures 1—4.)	LC	$I_{I, max}$	—	—	1.6	A
	LW	$I_{I, max}$	—	—	800	mA
Inrush Transient	All	I^2t	—	—	0.2	A ² s
Input Reflected-ripple Current (5 Hz to 20 MHz; 12 μ H source impedance; $T_A = 25$ °C; see Figure 33.)	All	I_r	—	5	—	mAp-p
Input Ripple Rejection (100 Hz—120 Hz)	All	—	—	45	—	dB

Fusing Considerations

CAUTION: This power module is not internally fused. An input line fuse must always be used.

This encapsulated power module can be used in a wide variety of applications, ranging from simple stand-alone operation to an integrated part of a sophisticated power architecture. To preserve maximum flexibility, internal fusing is not included; however, to achieve maximum safety and system protection, always use an input line fuse. The safety agencies require a normal-blow, dc fuse with a maximum rating of 5 A (see Safety Considerations section). Based on the information provided in this data sheet on inrush energy and maximum dc input current, the same type of fuse with a lower rating can be used. Refer to the fuse manufacturer's data for further information.

Electrical Specifications (continued)

Table 2. Output Specifications

Parameter	Device Code or Suffix	Symbol	Min	Typ	Max	Unit	
Output Voltage Set Point ($V_I = V_{I, \text{nom}}$; $I_O = I_{O, \text{max}}$; $T_A = 25\text{ }^\circ\text{C}$)	D	$V_{O, \text{set}}$	1.92	2.0	2.08	Vdc	
	G*	$V_{O, \text{set}}$	—	2.5	—	Vdc	
	F	$V_{O, \text{set}}$	3.17	3.3	3.43	Vdc	
	A	$V_{O, \text{set}}$	4.85	5.0	5.20	Vdc	
	B	$V_{O, \text{set}}$	11.52	12.0	12.48	Vdc	
	C	$V_{O, \text{set}}$	14.40	15.0	15.60	Vdc	
	AJ	$V_{O1, \text{set}}$	4.75	5.0	5.25	Vdc	
		$V_{O2, \text{set}}$	-4.75	-5.0	-5.25	Vdc	
	BK	$V_{O1, \text{set}}$	11.40	12.0	12.60	Vdc	
		$V_{O2, \text{set}}$	-11.40	-12.0	-12.60	Vdc	
	CL	$V_{O1, \text{set}}$	14.25	15.0	15.75	Vdc	
		$V_{O2, \text{set}}$	-14.25	-15.0	-15.75	Vdc	
Output Voltage (Over all line, load, and temperature conditions until end of life; see Figures 35 and 37.)	D	$V_{O, \text{set}}$	1.90	—	2.10	Vdc	
	G*	$V_{O, \text{set}}$	—	2.5	—	Vdc	
	F	$V_{O, \text{set}}$	3.13	—	3.47	Vdc	
	A	$V_{O, \text{set}}$	4.80	—	5.25	Vdc	
	B	$V_{O, \text{set}}$	11.40	—	12.60	Vdc	
	C	$V_{O, \text{set}}$	14.25	—	15.75	Vdc	
	AJ	$V_{O1, \text{set}}$	4.5	—	5.5	Vdc	
		$V_{O2, \text{set}}$	-4.5	—	-5.5	Vdc	
	BK	$V_{O1, \text{set}}$	10.80	—	13.20	Vdc	
		$V_{O2, \text{set}}$	-10.80	—	-13.20	Vdc	
	CL	$V_{O1, \text{set}}$	13.50	—	16.50	Vdc	
		$V_{O2, \text{set}}$	-13.50	—	-16.50	Vdc	
Output Regulation (See Figures 5—11): Line ($V_I = V_{I, \text{min}}$ to $V_{I, \text{max}}$)	A, F, D, G*	—	—	—	5	mV	
		B, C	—	—	0.01	0.1	% V_O
	Lx010 A, F, D, G*	—	—	—	—	10	mV
		B, C	—	—	0.1	0.2	% V_O
	Lx015 A, F, D, G*	—	—	—	—	15	mV
		B, C	—	—	0.1	0.2	% V_O
	Temperature ($T_C = -40\text{ }^\circ\text{C}$ to $+85\text{ }^\circ\text{C}$)	A, F, D, G*	—	—	—	25	mV
		B, C	—	—	—	100	mV
Output Ripple and Noise (Across 2 x 0.47 μF ceramic capacitors; see Figures 34 and 36.): RMS	A, D, F, G*	—	—	—	30	mVrms	
		AJ, B, C	—	—	—	35	mVrms
		BK, CL	—	—	—	50	mVrms
	Peak-to-peak (5 Hz to 20 MHz)	A, D, F, G*	—	—	—	100	mVp-p
		AJ, B, C	—	—	—	120	mVp-p
		BK, CL	—	—	—	150	mVp-p
	External Load Capacitance	A, F, D, G*	—	—	—	1000	μF
		B, C	—	—	—	200	μF

* For a 2.5 V output, use the 2 V output module (D code) with an output voltage trim pin (optional feature).

Electrical Specifications (continued)

Table 2. Output Specifications (continued)

Parameter	Device Code or Suffix	Symbol	Min	Typ	Max	Unit
Output Current (At $I_o < I_{o, \text{min}}$, the modules may exceed output ripple specifications, but operation is guaranteed.) Note: On the Lx01xF, the output voltage may exceed specifications when $I_o < I_{o, \text{min}}$.	Lx015D	I_o	0.35	—	3.0	A
	Lx015F	I_o	0.25	—	3.0	A
	Lx015A	I_o	0.15	—	3.0	A
	Lx015B	I_o	0.12	—	1.25	A
	Lx015C	I_o	0.10	—	1.0	A
	Lx010D, G*	I_o	0.2	—	2.0	A
	Lx010F	I_o	0.15	—	2.42	A
	Lx010A	I_o	0.1	—	2.0	A
	Lx010B	I_o	0.08	—	0.83	A
	Lx010C	I_o	0.06	—	0.67	A
	Lx010AJ	I_{o1}, I_{o2}	0.1	—	1.0	A
	Lx010BK	I_{o1}, I_{o2}	0.06	—	0.42	A
	Lx010CL	I_{o1}, I_{o2}	0.05	—	0.33	A
	Output Current-limit Inception ($V_o = 90\% V_{o, \text{set}}$; see Figures 12—14.)	Lx015D	I_o	—	—	7.5
Lx015F		I_o	—	—	6.5	A
Lx015A		I_o	—	—	5	A
Lx015B		I_o	—	—	3.1	A
Lx015C		I_o	—	—	2.5	A
Lx010D, G*		I_o	—	—	7.0	A
Lx010F		I_o	—	—	5	A
Lx010A		I_o	—	—	4	A
Lx010B		I_o	—	—	2.5	A
Lx010C		I_o	—	—	2	A
Lx010AJ		I_{o1}, I_{o2}	—	—	4.0	A
Lx010BK		I_{o1}, I_{o2}	—	—	2.5	A
Lx010CL		I_{o1}, I_{o2}	—	—	2.5	A
Output Short-circuit Current ($V_o = 0.25 \text{ V}$)		Lx015D	I_o	—	—	8.5
	Lx015F	I_o	—	—	8.5	A
	Lx015A	I_o	—	—	7.5	A
	Lx015B	I_o	—	—	4.5	A
	Lx015C	I_o	—	—	4.5	A
	Lx010D, G*	I_o	—	—	8	A
	Lx010F	I_o	—	—	7.5	A
	Lx010A	I_o	—	—	6	A
	Lx010B	I_o	—	—	3.5	A
	Lx010C	I_o	—	—	3.5	A
	Lx010AJ	I_{o1}, I_{o2}	—	—	6.0	A
	Lx010BK	I_{o1}, I_{o2}	—	—	3.5	A
	Lx010CL	I_{o1}, I_{o2}	—	—	3.5	A

* For a 2.5 V output, use the 2 V output module (D code) with an output voltage trim pin (optional feature).

Electrical Specifications (continued)

Table 2. Output Specifications (continued)

Parameter	Device Code or Suffix	Symbol	Min	Typ	Max	Unit
Efficiency ($V_I = V_{I, \text{nom}}$; $I_O = I_{O, \text{max}}$; $T_A = 25\text{ }^\circ\text{C}$; see Figures 15—28, 35, and 37.)	LC015D	η	64	67	—	%
	LC015F	η	74	77	—	%
	LC015A	η	77	80	—	%
	LC015B, C	η	73	76	—	%
	LC010D, G*	η	65	68	—	%
	LC010F	η	71	75	—	%
	LC010A, B, C	η	75	79	—	%
	LC010AJ, BK, CL	η	75	78	—	%
	LW015D	η	66	69	—	%
	LW015F	η	76	79	—	%
	LW015A	η	79	82	—	%
	LW015B, C	η	75	78	—	%
	LW010D, G*	η	67	70	—	%
	LW010F	η	73	76	—	%
	LW010A, B, C	η	77	81	—	%
LW010AJ, BK, CL	η	77	80	—	%	
Efficiency ($V_I = V_{I, \text{nom}}$; $I_O = 2\text{ A}$; $T_A = 25\text{ }^\circ\text{C}$; see Figures 15, 18, 22, and 25.)	LC015F	η	—	79	—	%
	LC015A	η	—	82	—	%
	LW015F	η	—	82	—	%
	LW015A	η	—	84	—	%
Switching Frequency	All	—	—	265	—	kHz
Dynamic Response (for duals: I_{O1} or $I_{O2} = I_{O, \text{max}}$; $\Delta I_O/\Delta t = 1\text{ A}/10\text{ }\mu\text{s}$; $V_I = V_{I, \text{nom}}$; $T_A = 25\text{ }^\circ\text{C}$; see Figures 29 and 30.): Load Change from $I_O = 50\%$ to 75% of $I_{O, \text{max}}$: Peak Deviation Settling Time ($V_O < 10\%$ of peak deviation) Load Change from $I_O = 50\%$ to 25% of $I_{O, \text{max}}$: Peak Deviation Settling Time ($V_O < 10\%$ of peak deviation)	All	—	—	2	—	% $V_{O, \text{set}}$
	All	—	—	0.8	—	ms
	All	—	—	2	—	% $V_{O, \text{set}}$
	All	—	—	0.8	—	ms

* For a 2.5 V output, use the 2 V output module (D code) with an output voltage trim pin (optional feature).

Table 3. Isolation Specifications

Parameter	Min	Typ	Max	Unit
Isolation Capacitance	—	600	—	pF
Isolation Resistance	10	—	—	M Ω

Electrical Specifications (continued)

Table 4. General Specifications

Parameter	Min	Typ	Max	Unit
Calculated MTBF ($I_o = 80\%$ of $I_{o, max}$; $T_c = 40\text{ }^\circ\text{C}$):				
Lx010	—	7,800,000	—	hours
Lx015	—	5,400,000	—	hours
Weight	—	—	28.3 (1.0)	g (oz.)
Hand Soldering (soldering iron 3 mm (0.125 in.) tip, $425\text{ }^\circ\text{C}$)	—	—	12	s

Table 5. Feature Specifications

Parameter	Device Code or Suffix	Symbol	Min	Typ	Max	Unit
Remote On/Off Signal Interface (optional): ($V_I = 0\text{ V}$ to $V_{I, max}$; open collector or equivalent compatible; signal referenced to $V_I(-)$ terminal. See Figure 38 and Feature Descriptions.):						
Positive Logic— Device Code Suffix “4”:						
Logic Low—Module Off						
Logic High—Module On						
Negative Logic— Device Code Suffix “1”:						
Logic Low—Module On						
Logic High—Module Off						
Module Specifications:						
On/Off Current—Logic Low	All	$I_{on/off}$	—	—	1.0	mA
On/Off Voltage:						
Logic Low	All	$V_{on/off}$	-0.7	—	1.2	V
Logic High ($I_{on/off} = 0$)	All	$V_{on/off}$	—	—	10	V
Open Collector Switch Specifications:						
Leakage Current During Logic High ($V_{on/off} = 10\text{ V}$)	All	$I_{on/off}$	—	—	50	μA
Output Low Voltage During Logic Low ($I_{on/off} = 1\text{ mA}$)	All	$V_{on/off}$	—	—	1.2	V
Turn-on Delay and Rise Times (At 80% of $I_{o, max}$; $T_A = 25\text{ }^\circ\text{C}$; see Figures 31 and 32.):						
Case 1: On/Off Input Is Set for Unit On and then Input Power Is Applied (delay from point at which $V_I = V_{I, min}$ until $V_O = 10\%$ of $V_{O, nom}$).	All	T_{delay}	—	5	20	ms
Case 2: Input Power Is Applied for at Least One Second, and then the On/Off Input Is Set to Turn the Module On (delay from point at which on/off input is toggled until $V_O = 10\%$ of $V_{O, nom}$).	All	T_{delay}	—	1	10	ms
Output Voltage Rise Time (time for V_O to rise from 10% of $V_{O, nom}$ to 90% of $V_{O, nom}$)	All	T_{rise}	—	0.2	5	ms
Output Voltage Overshoot (at 80% of $I_{o, max}$; $T_A = 25\text{ }^\circ\text{C}$)	All	—	—	—	5	%

Electrical Specifications (continued)

Table 5. Feature Specifications (continued)

Parameter	Device Code or Suffix	Symbol	Min	Typ	Max	Unit
Output Voltage Set-point Adjustment Range (optional: single outputs only)	A, B, F	—	90	—	110	% $V_{O, nom}$
	C	—	90	—	100	% $V_{O, nom}$
	D	—	90	—	125	% $V_{O, nom}$
Output Overvoltage Clamp ($V_{O, clamp}$ may be set higher on units with output voltage set-point adjustment option.)	D	$V_{O, clamp}$	2.60	—	4.0	V
	F	$V_{O, clamp}$	3.7	—	5.7	V
	A	$V_{O, clamp}$	5.6	—	7.0	V
	B	$V_{O, clamp}$	13.2	—	16.0	V
	C	$V_{O, clamp}$	16.5	—	21.0	V
	AJ	$V_{O1, clamp}$	5.6	—	7.0	V
		$V_{O2, clamp}$	-5.6	—	-7.0	V
	BK	$V_{O1, clamp}$	13.2	—	18.0	V
		$V_{O2, clamp}$	-13.2	—	-18.0	V
	CL	$V_{O1, clamp}$	16.5	—	21.0	V
	$V_{O2, clamp}$	-16.5	—	-21.0	V	
Undervoltage Lockout	LCxxx	V_{uvlo}	11	14	—	V
	LWxxx	V_{uvlo}	20	27	—	V

Characteristic Curves

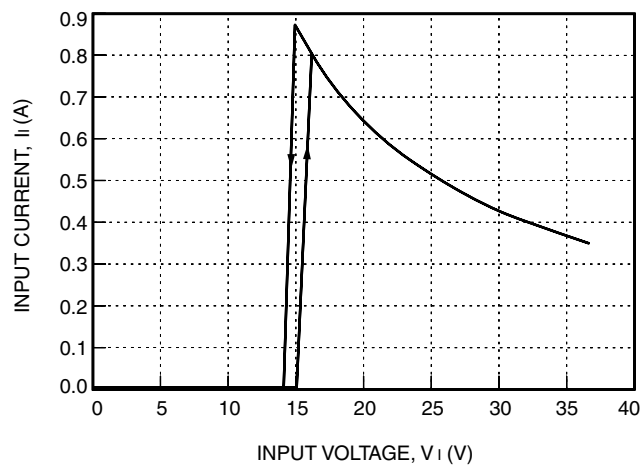

Figure 1. LC010 Input Current vs. Input Voltage at $I_o = I_{o, max}$ and $T_c = 25\text{ }^\circ\text{C}$

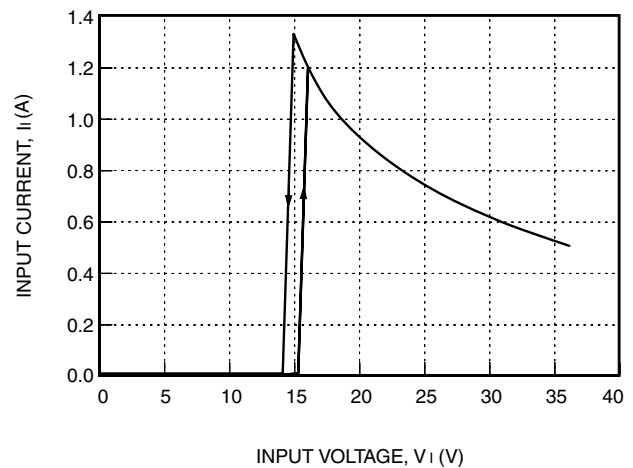
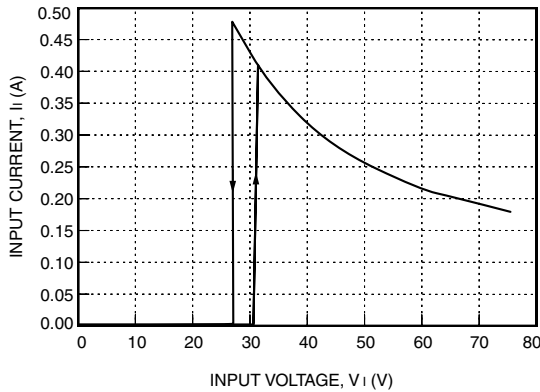

Figure 2. LC015 Input Current vs. Input Voltage at $I_o = I_{o, max}$ and $T_c = 25\text{ }^\circ\text{C}$

Characteristics Curves (continued)



8-1787(C)

Figure 3. LW010 Input Current vs. Input Voltage at $I_{o1} = I_{o, \max}$ and $T_c = 25^\circ\text{C}$

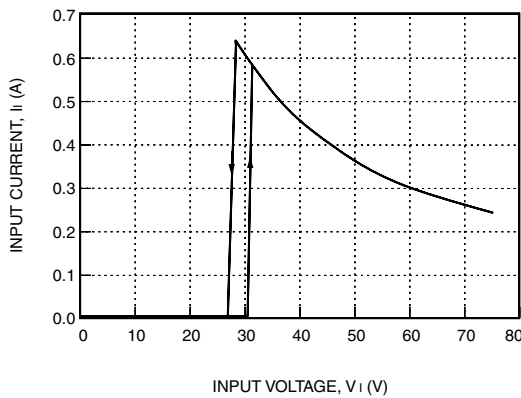

8-1788(C)

Figure 4. LW015 Input Current vs. Input Voltage at $I_{o1} = I_{o, \max}$ and $T_c = 25^\circ\text{C}$

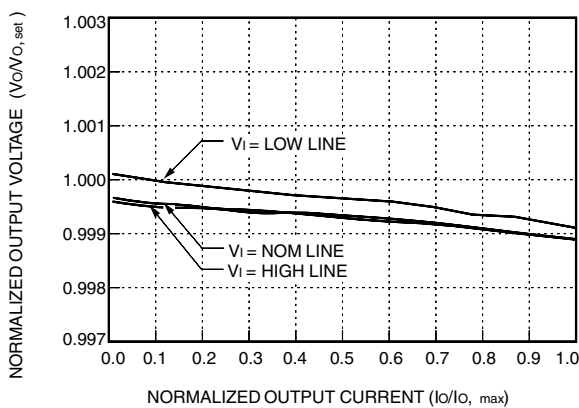

8-1789(C)

Figure 5. Lx010x/Lx015x Single-Output Load Regulation, Normalized Output Voltage vs. Normalized Output Current at $T_c = 25^\circ\text{C}$

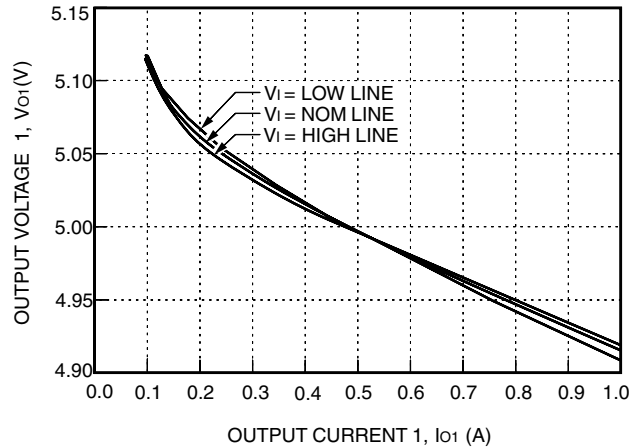

8-1790(C)

Note: Output2 has characteristics similar to output1 when $I_{o1} = 0.5\text{ A}$ and I_{o2} varies.

Figure 6. Lx010AJ Typical Load Regulation of Output1 with Fixed $I_{o2} = 0.5\text{ A}$ at $T_c = 25^\circ\text{C}$

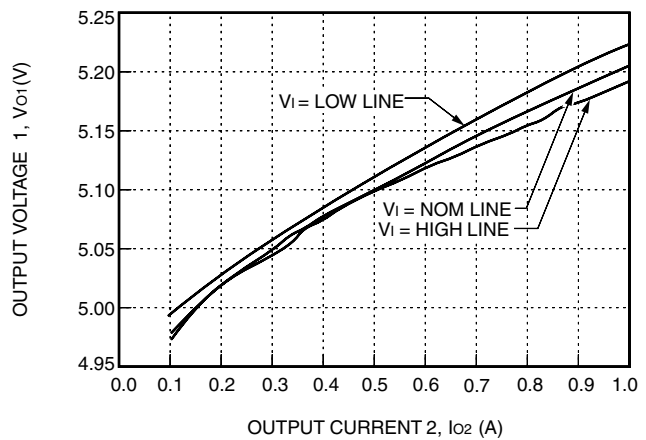

8-1791(C)

Note: Output2 has characteristics similar to output1 when $I_{o2} = 0.1\text{ A}$ and I_{o1} varies.

Figure 7. Lx010AJ Typical Cross Regulation, V_{o1} vs. I_{o2} with Fixed $I_{o1} = 0.1\text{ A}$ at $T_c = 25^\circ\text{C}$

Characteristics Curves (continued)

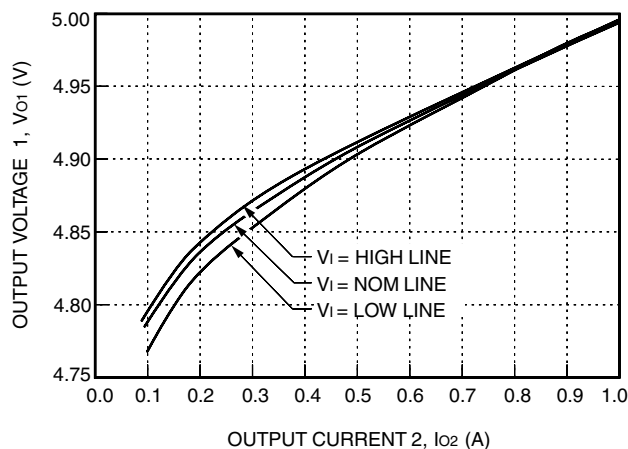

8-1792(C)

Note: Output2 has characteristics similar to output1 when $I_{o2} = 1.0 \text{ A}$ and I_{o1} varies.

Figure 8. Lx010AJ Typical Cross Regulation, V_{o1} vs. I_{o2} with Fixed $I_{o1} = 1.0 \text{ A}$ at $T_c = 25 \text{ }^\circ\text{C}$

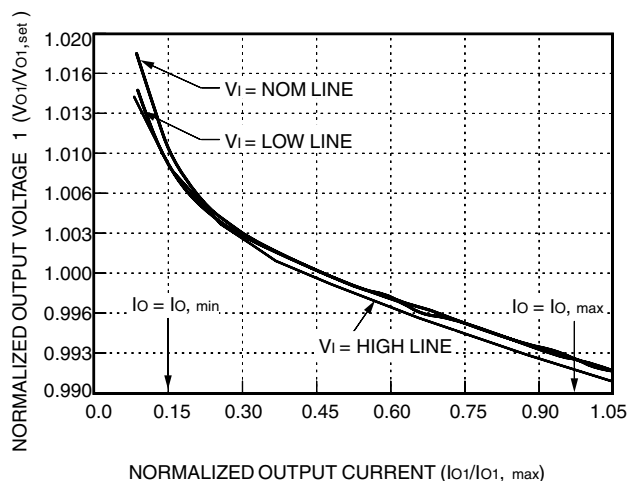

8-1793(C)

Note: Output2 has characteristics similar to output1 when $I_{o1} = (0.5 * I_{o, \text{max}})$ and I_{o2} varies.

Figure 9. Lx010BK, CL Load Regulation of Output1 with Fixed $I_{o2} = 0.5 * I_{o, \text{max}}$ at $T_c = 25 \text{ }^\circ\text{C}$, Normalized V_{o1} vs. Normalized Current I_{o1}

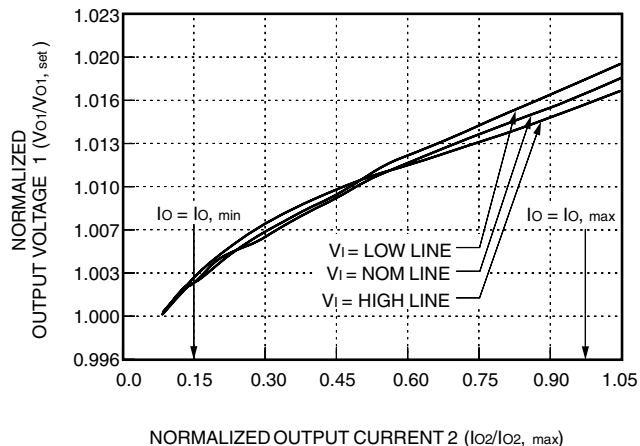

8-1794(C)

Note: Output2 has characteristics similar to output1 when $I_{o2} = I_{o, \text{min}}$ and I_{o1} varies.

Figure 10. Lx010BK, CL Typical Cross Regulation, Normalized V_{o1} vs. Normalized I_{o2} with Fixed $I_{o1} = I_{o, \text{min}}$ at $T_c = 25 \text{ }^\circ\text{C}$

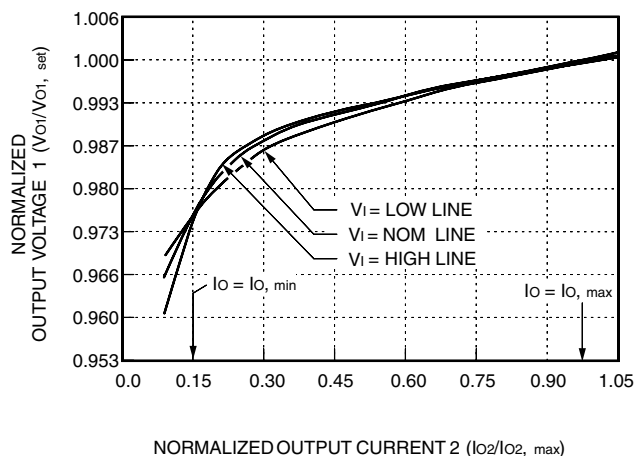

8-1795(C)

Note: Output2 has characteristics similar to output1 when $I_{o2} = I_{o, \text{max}}$ and I_{o1} varies.

Figure 11. Lx010BK, CL Typical Cross Regulation, Normalized V_{o1} vs. Normalized I_{o2} with Fixed $I_{o1} = I_{o, \text{max}}$ at $T_c = 25 \text{ }^\circ\text{C}$

Characteristics Curves (continued)

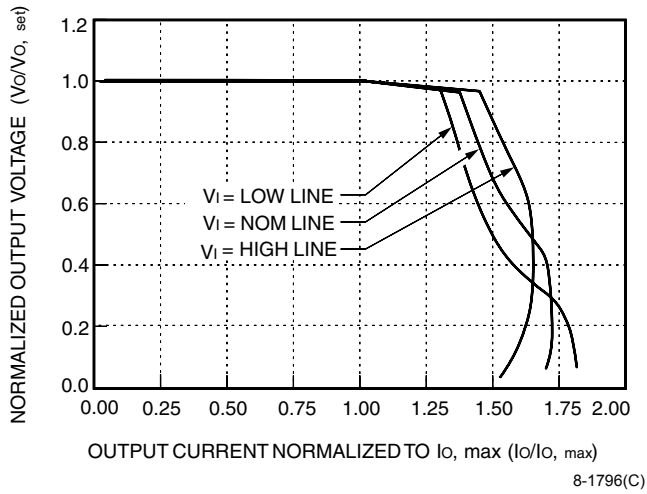
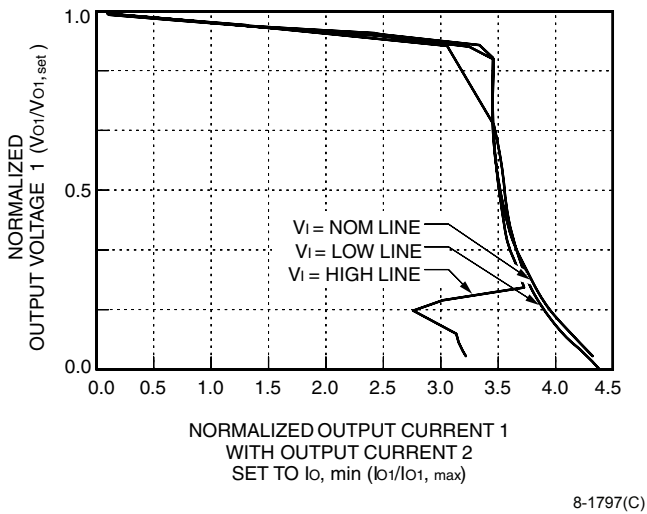
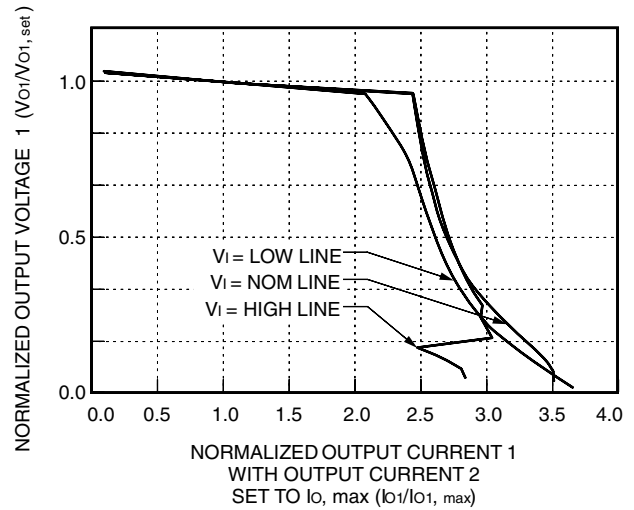

Figure 12. Lx010x/Lx015x Single-Output Normalized Output Current vs. Normalized Output Voltage at $T_c = 25^\circ\text{C}$



Note: Output2 has characteristics similar to output1 when output1 is set to $I_{o, \min}$.

Figure 13. Lx010xx Dual-Output Normalized Output Current vs. Normalized Output Voltage at $T_c = 25^\circ\text{C}$ with Other Output at $I_{o, \min}$



Note: Output2 has characteristics similar to output1 when output1 is set to $I_{o, \max}$.

Figure 14. Lx010xx Dual-Output Normalized Output Current vs. Normalized Output Voltage at $T_c = 25^\circ\text{C}$ with Other Output at $I_{o, \max}$

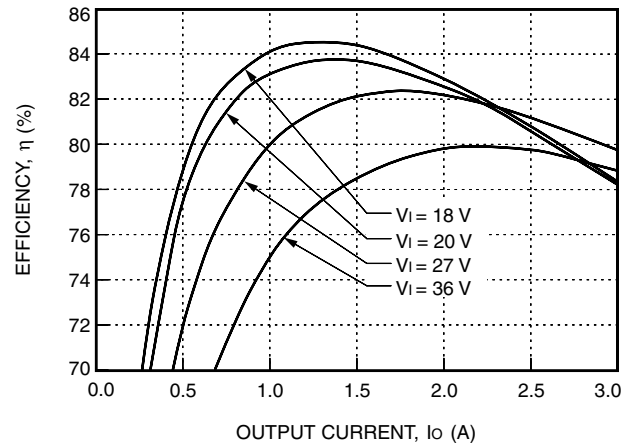

Figure 15. LC015A Typical Efficiency vs. Output Current at $T_c = 25^\circ\text{C}$

Characteristics Curves (continued)

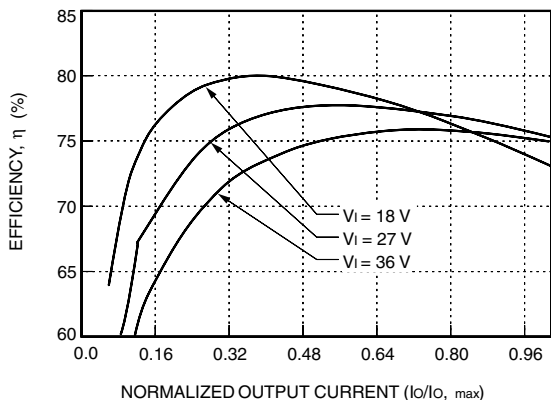

Figure 16. LC015B, C Typical Efficiency vs. Normalized Output Current at Tc = 25 °C

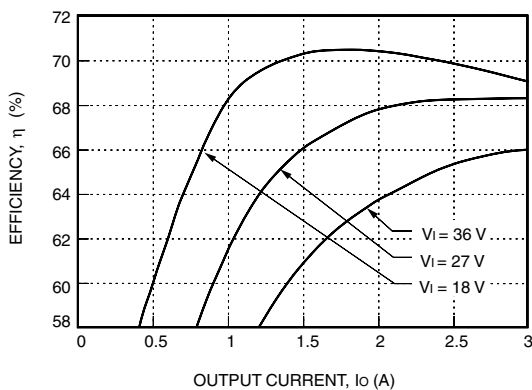

Figure 17. LC010D and LC015D Typical Efficiency vs. Output Current at Tc = 25 °C

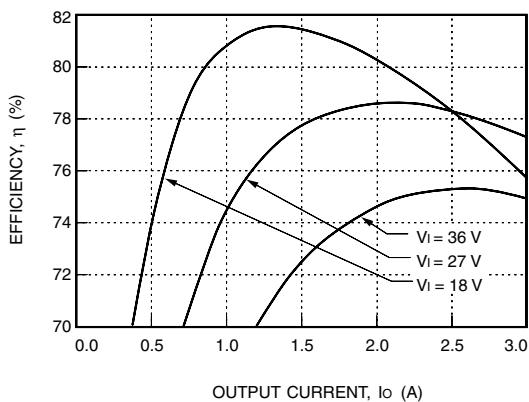

Figure 18. LC015F Typical Efficiency vs. Output Current at Tc = 25 °C

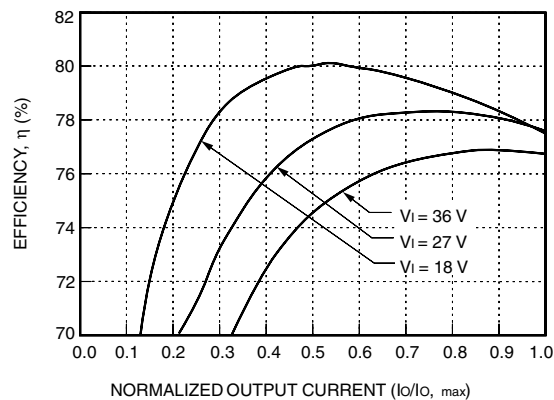

Figure 19. LC010A, B, C Typical Efficiency vs. Normalized Output Current at Tc = 25 °C

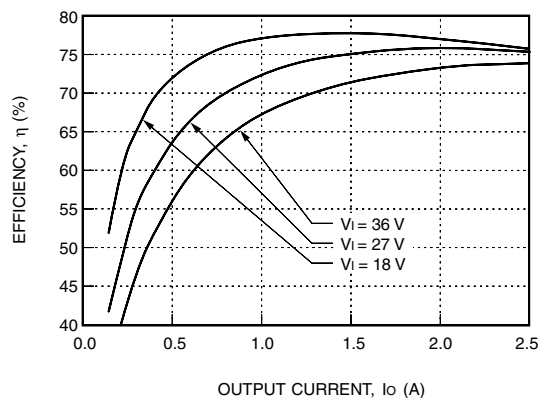

Figure 20. LC010F Typical Efficiency vs. Output Current at Tc = 25 °C

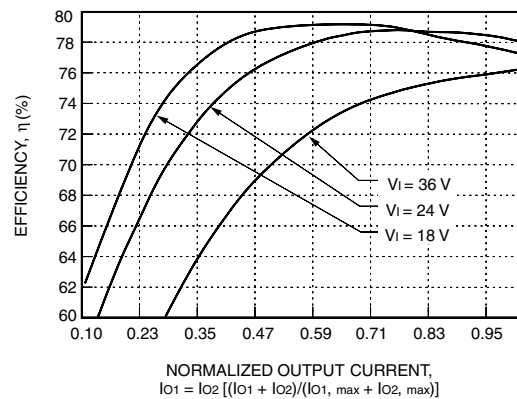

Figure 21. LC010AJ, BK, CL Typical Efficiency vs. Normalized Output Current at Tc = 25 °C

Characteristics Curves (continued)

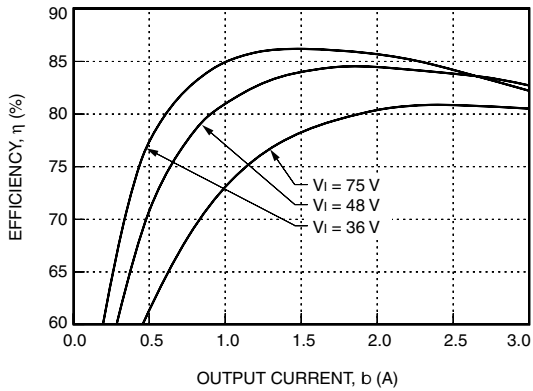

Figure 22. LW015A Typical Efficiency vs. Output Current at $T_c = 25\text{ }^\circ\text{C}$

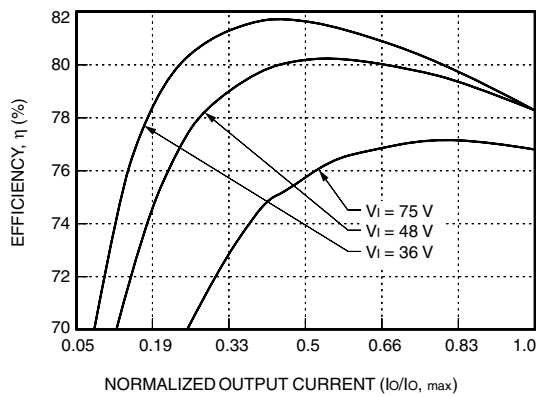

Figure 23. LW015B, C Typical Efficiency vs. Normalized Output Current at $T_c = 25\text{ }^\circ\text{C}$

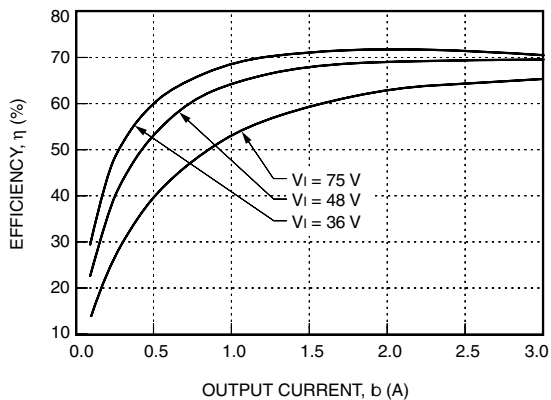

Figure 24. LW010D, 015D Typical Efficiency vs. Output Current at $T_c = 25\text{ }^\circ\text{C}$

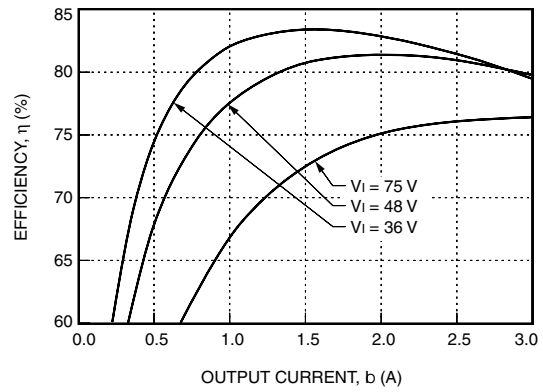

Figure 25. LW015F Typical Efficiency vs. Output Current at $T_c = 25\text{ }^\circ\text{C}$

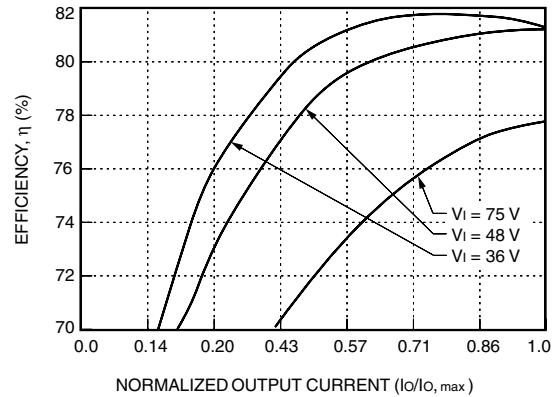

Figure 26. LW010A, B, C Typical Efficiency vs. Normalized Output Current at $T_c = 25\text{ }^\circ\text{C}$

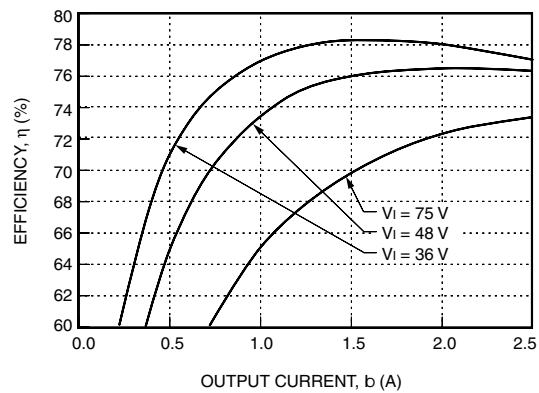
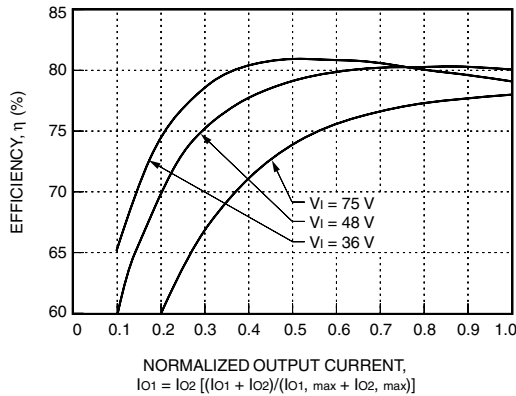

Figure 27. LW010F Typical Efficiency vs. Output Current at $T_c = 25\text{ }^\circ\text{C}$

Characteristics Curves (continued)



8-1858(C)

Figure 28. LW010AJ, BK, CL Typical Efficiency vs. Normalized Output Current at Tc = 25 °C

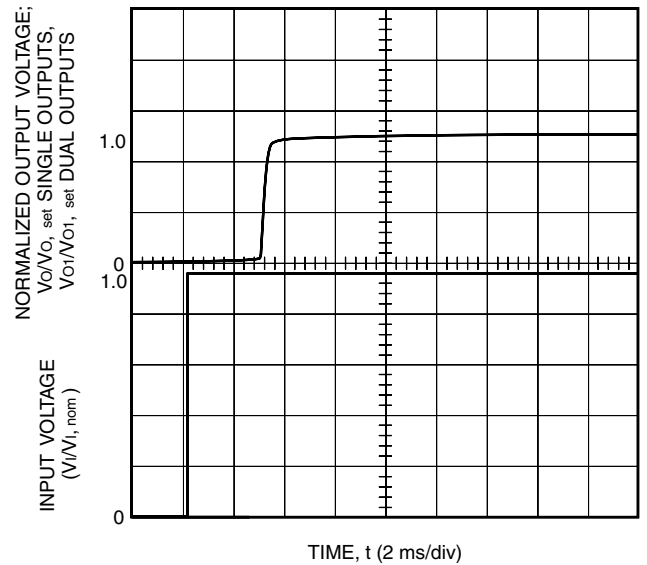

8-1806(C)

Figure 31. Typical Output Voltage Start-Up when Input Voltage Is Applied; $i_o = 80\%$ of $i_{o, max}$, $V_i =$ Nominal Line

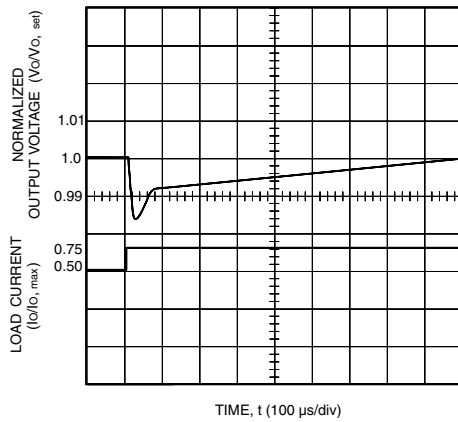

8-1857(C)

Figure 29. Single-Output Typical Output Voltage for Step Load Change from 50% to 75% of $i_o = i_{o, max}$

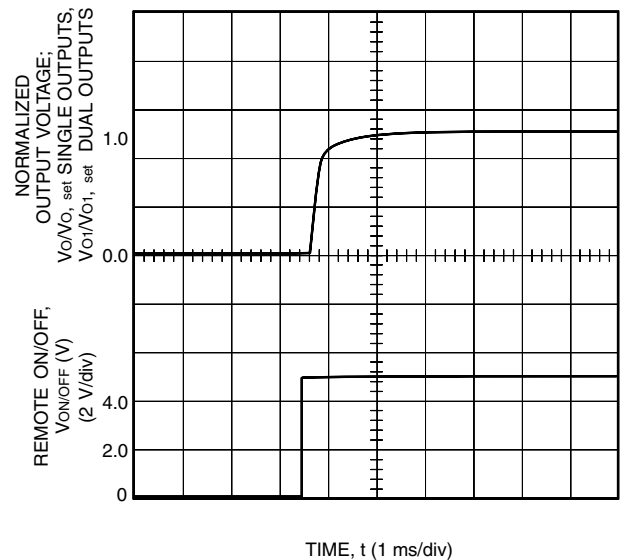

8-1807(C),a

Figure 32. Typical Output Voltage Start-Up when Signal Is applied to Remote On/Off; $i_o = 80\%$ of $i_{o, max}$

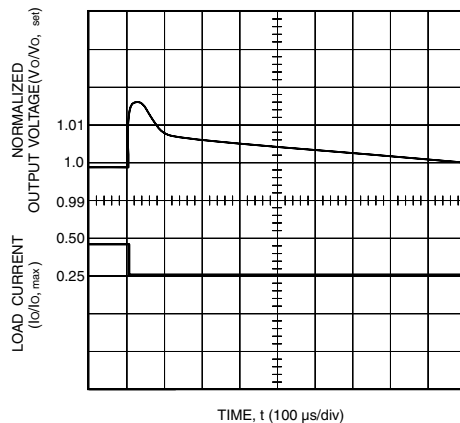

8-1856(C)

Figure 30. Single-Output Typical Output Voltage for Step Load Change from 50% to 25% of $i_o = i_{o, max}$

Test Configurations

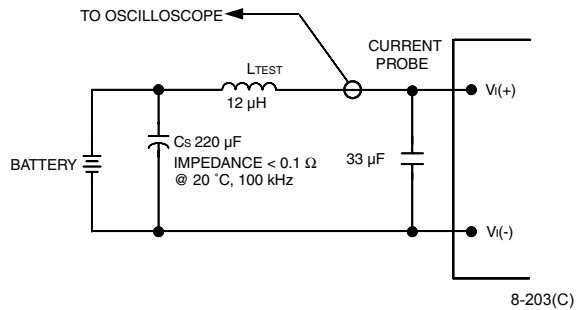

Note: Input reflected-ripple current is measured with a simulated source impedance of 12 μH. Capacitor Cs offsets possible battery impedance. Current is measured at the input of the module.

Figure 33. Input Reflected-Ripple Test Setup

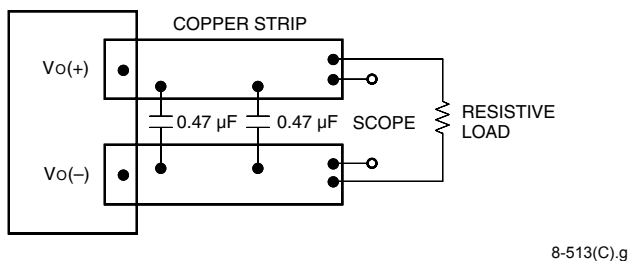

Note: Use two 0.47 μF ceramic capacitors. Scope measurement should be made using a BNC socket. Position the load between 50 mm and 75 mm (2 in. and 3 in.) from the module.

Figure 34. Peak-to-Peak Output Noise Measurement Test Setup for Single Outputs

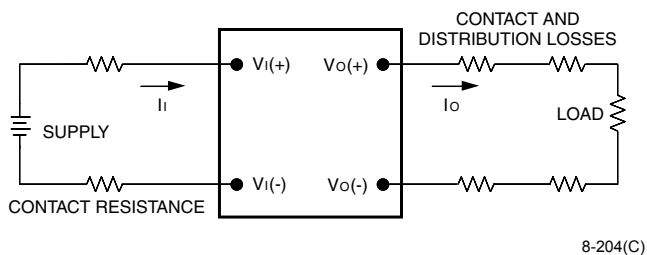

Note: All measurements are taken at the module terminals. When socketing, place Kelvin connections at module terminals to avoid measurement errors due to socket contact resistance.

$$\eta = \left(\frac{[V_{O(+)} - V_{O(-)}] I_{O}}{[V_{I(+)} - V_{I(-)}] I_{I}} \right) \times 100$$

Figure 35. Output Voltage and Efficiency Measurement Test Setup for Single Outputs

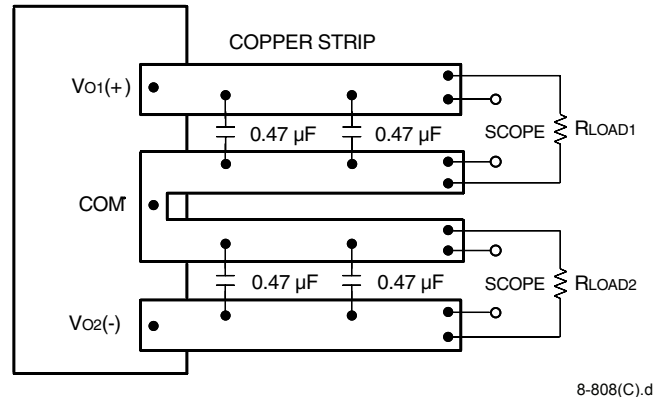

Note: Use four 0.47 μF ceramic capacitors. Scope measurement should be made using a BNC socket. Position the load between 50 mm and 75 mm (2 in. and 3 in.) from the module.

Figure 36. Peak-to-Peak Output Noise Measurement Test Setup for Dual Outputs

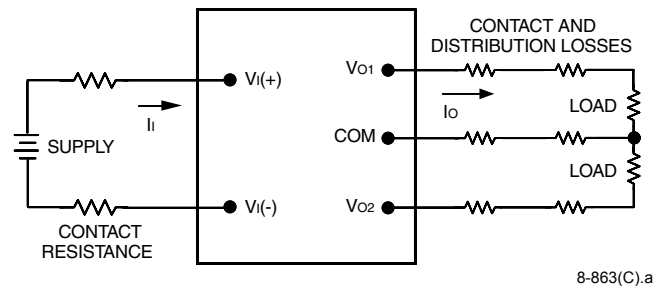

Note: All measurements are taken at the module terminals. When socketing, place Kelvin connections at module terminals to avoid measurement errors due to socket contact resistance.

$$\eta = \left[\frac{\sum_{j=1}^2 |[V_{Oj} - COM] I_{Oj}|}{[V_{I(+)} - V_{I(-)}] I_{I}} \right] \times 100$$

Figure 37. Output Voltage and Efficiency Measurement Test Setup for Dual Outputs

Design Considerations

Input Source Impedance

The power module should be connected to a low ac-impedance input source. Highly inductive source impedances can affect the stability of the power module. If the source inductance exceeds 4 μH , a 33 μF electrolytic capacitor (ESR < 0.7 Ω at 100 kHz) mounted close to the power module helps ensure stability of the unit.

Safety Considerations

For safety-agency approval of the system in which the power module is used, the power module must be installed in compliance with the spacing and separation requirements of the end-use safety agency standard, i.e., UL 1950, CSA 22.2 No. 950-95, EN60950, and IEC950.

For the converter output to be considered meeting the requirements of safety extra-low voltage (SELV), one of the following must be true of the dc input:

- All inputs are SELV and floating, with the output also floating.
- All inputs are SELV and grounded, with the output also grounded.
- Any non-SELV input must be provided with reinforced insulation from any other hazardous voltages, including the ac mains, and must have a SELV reliability test performed on it in combination with the converters.

The power module has extra-low voltage (ELV) outputs when all inputs are ELV.

The input to these units is to be provided with a maximum 5 A normal-blow fuse in the ungrounded lead.

Feature Descriptions

Output Overvoltage Clamp

The output overvoltage clamp consists of control circuitry, independent of the primary regulation loop, that monitors the voltage on the output terminals. This control loop has a higher voltage set point than the primary loop (see Feature Specifications table). In a fault condition, the overvoltage clamp ensures that the output voltage does not exceed $V_{O, \text{clamp, max}}$. This provides a redundant voltage-control that reduces the risk of output overvoltage.

Lineage Power

Current Limit

To provide protection in a fault (output overload) condition, the unit is equipped with internal current-limiting circuitry and can endure current limiting for an unlimited duration. At the point of current-limit inception, the unit shifts from voltage control to current control. If the output voltage is pulled very low during a severe fault, the current-limit circuit can exhibit either foldback or tailout characteristics (output-current decrease or increase). The unit operates normally once the output current is brought back into its specified range.

Remote On/Off (Optional)

Two remote on/off options are available. Positive logic, device code suffix "4", remote on/off turns the module on during a logic-high voltage on the remote ON/OFF pin, and off during a logic low. Negative logic, device code suffix "1", remote on/off turns the module off during a logic high and on during a logic low.

To turn the power module on and off, the user must supply a switch to control the voltage between the on/off terminal and the $V_I(-)$ terminal ($V_{\text{on/off}}$). The switch may be an open collector or equivalent (see Figure 38). A logic low is $V_{\text{on/off}} = -0.7 \text{ V to } +1.2 \text{ V}$. The maximum $I_{\text{on/off}}$ during a logic low is 1 mA. The switch should maintain a logic-low voltage while sinking 1 mA.

During a logic high, the maximum $V_{\text{on/off}}$ generated by the power module is 10 V. The maximum allowable leakage current of the switch at $V_{\text{on/off}} = 10 \text{ V}$ is 50 μA .

The module has internal capacitance to reduce noise at the ON/OFF pin. Additional capacitance is not generally needed and may degrade the start-up characteristics of the module.

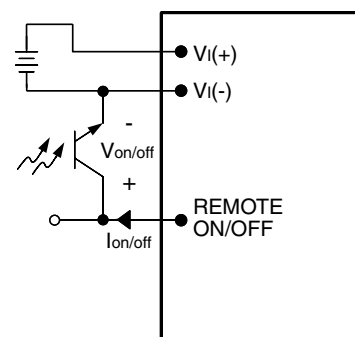

8-758(C).a

Figure 38. Remote On/Off Implementation

Feature Descriptions (continued)

Output Voltage Adjustment (Optional on Single-Output Units)

Output voltage set-point adjustment allows the user to increase or decrease the output voltage set point of a module. This is accomplished by connecting an external resistor between the TRIM pin and either the Vo(+) or Vo(-) pins. With an external resistor between the TRIM and Vo(+) pins (R_{adj-down}), the output voltage set point (V_{O, adj}) decreases (see Figure 39). The following equation determines the required external resistor value to obtain an output voltage change from V_{O, nom} to V_{O, adj}:

$$R_{\text{adj-down}} = \left[\frac{(V_{O, \text{adj}} - L)G}{(V_{O, \text{nom}} - V_{O, \text{adj}})} - H \right] \Omega$$

where R_{adj-down} is the resistance value connected between TRIM and Vo(+), and G, H, and L are defined in the following table.

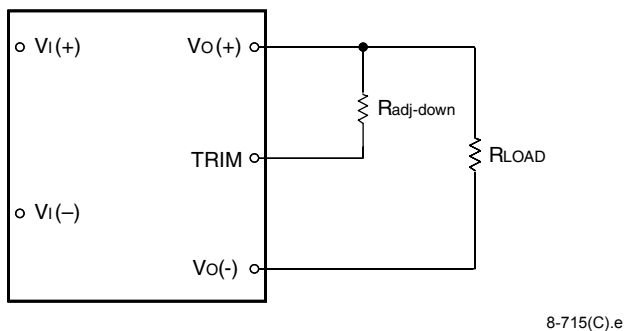

Figure 39. Circuit Configuration to Decrease Output Voltage

With an external resistor connected between the TRIM and Vo(-) pins (R_{adj-up}), the output voltage set point (V_{O, adj}) increases (see Figure 40). The following equation determines the required external resistor value to obtain an output voltage from V_{O, nom} to V_{O, adj}:

$$R_{\text{adj-up}} = \left(\left[\frac{GL}{(V_{O, \text{adj}} - L) - K} \right] - H \right) \Omega$$

where R_{adj-up} is the resistance value connected between TRIM and Vo (-), and the values of G, H, K, and L are shown in the following table:

	G	H	K	L
Lx010, 5A	5110	2050	2.5	2.5
Lx010, 5B	10,000	5110	9.5	2.5
Lx010, 5C	10,000	5110	NA	2.5
Lx010, 5D	5110	2050	0.76	1.23
Lx010, 5F	5110	2050	0.75	2.5

The combination of the output voltage adjustment and the output voltage tolerance cannot exceed 110% (125% for the D) of the nominal output voltage between the Vo(+) and Vo(-) terminals.

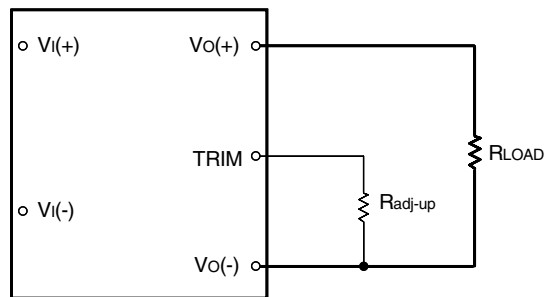

8-715(C).d

Figure 40. Circuit Configuration to Increase Output Voltage

The L-Series power modules have a fixed current-limit set point. Therefore, as the output voltage is adjusted down, the available output power is reduced. In addition, the minimum output current is a function of the output voltage. As the output voltage is adjusted down, the minimum required output current can increase (i.e., minimum power is constant).

Synchronization (Optional)

With external circuitry, the unit is capable of synchronization from an independent time base with a switching rate of 256 kHz. Other frequencies may be available; please consult the factory for application guidelines and/or a description of the external circuit needed to use this feature.

Thermal Considerations

The power module operates in a variety of thermal environments; however, sufficient cooling should be provided to help ensure reliable operation of the unit. Heat-dissipating components inside the unit are thermally coupled to the case. Heat is removed by conduction, convection, and radiation to the surrounding environment. Proper cooling can be verified by measuring the case temperature. The case temperature (T_c) should be measured at the position indicated in Figures 41 and 42.

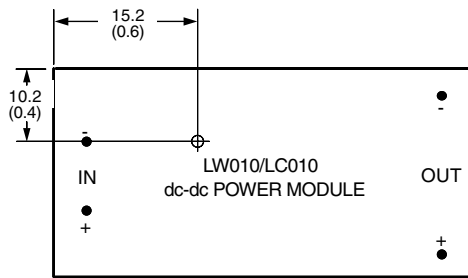

8-1363(C).b

Note: Dimensions are in millimeters and (inches). Pin locations are for reference only.

Figure 41. LW010 and LC010 Case Temperature Measurement Location

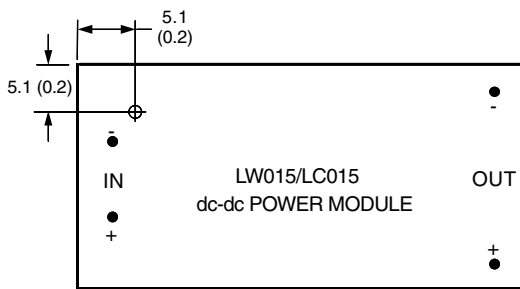

8-1363(C).c

Note: Dimensions are in millimeters and (inches). Pin locations are for reference only.

Figure 42. LW015 and LC015 Case Temperature Measurement Location

Note that the views in Figures 41 and 42 are of the surface of the modules. The temperatures at these locations should not exceed the maximum case temperature indicated on the derating curve. The output power of the module should not exceed the rated power for the module as listed in the Ordering Information table.

Heat Transfer Characteristics

Increasing airflow over the module enhances the heat transfer via convection. Figures 43 through 45 show the maximum power that can be dissipated by the module without exceeding the maximum case temperature versus local ambient temperature (T_A) for natural convection through 3.0 ms^{-1} (600 ft./min.).

Systems in which these power modules are used typically generate natural convection airflow rates of 0.25 ms^{-1} (50 ft./min.) due to other heat dissipating components in the system. Therefore, the natural convection condition represents airflow rates of approximately 0.25 ms^{-1} (50 ft./min.). Use of Figure 43 is shown in the following example.

Example

What is the minimum airflow necessary for an LW010A operating at 48 V, an output current of 2.0 A, and a maximum ambient temperature of $91 \text{ }^\circ\text{C}$?

Solution:

Given: $V_I = 48 \text{ V}$, $I_o = 2.0 \text{ A}$ ($I_{o, \text{max}}$), $T_A = 91 \text{ }^\circ\text{C}$
Determine P_D (Figure 58): $P_D = 2.5 \text{ W}$
Determine airflow (Figure 43): $v = 2.0 \text{ ms}^{-1}$
(400 ft./min.)

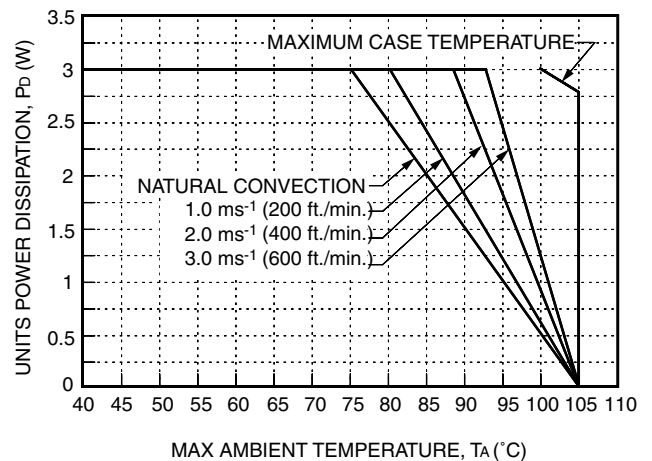

8-1375(C).a

Figure 43. LW010/LC010 Forced Convection Power Derating; Either Orientation

Thermal Considerations (continued)

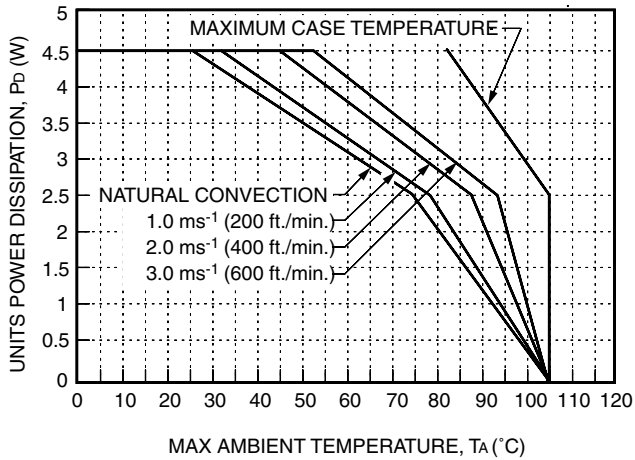

8-1377(C).a

Figure 44. LC015 Forced Convection Power Derating; Either Orientation

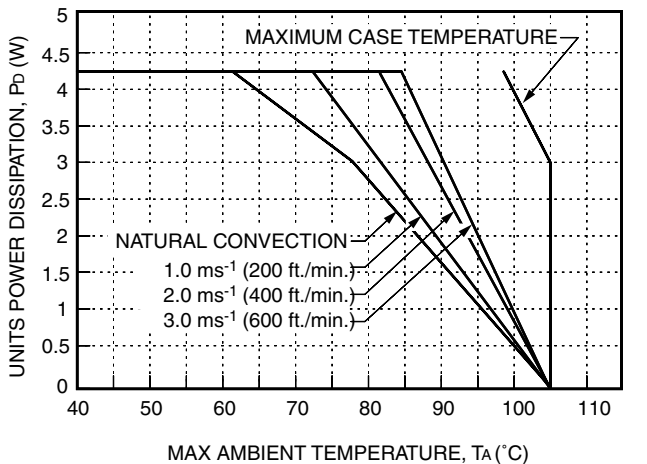

8-1376(C).a

Figure 45. LW015 Forced Convection Power Derating; Either Orientation

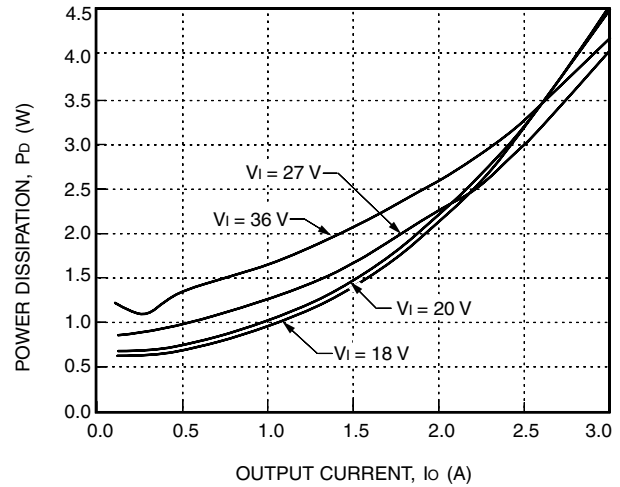

8-1382(C)

Note: The power dissipation of this unit is shown at $T_c = T_{c, \max}$ because the efficiency of this power module drops at high temperatures.

Figure 46. LC015A Power Dissipation at Maximum Case Temperature

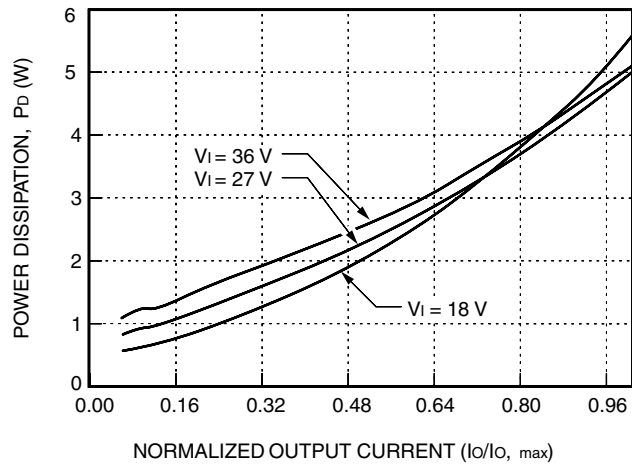

8-1808(C)

Figure 47. LC015B, C Typical Power Dissipation vs. Normalized Output Current at $T_c = 25^\circ\text{C}$

Thermal Considerations (continued)

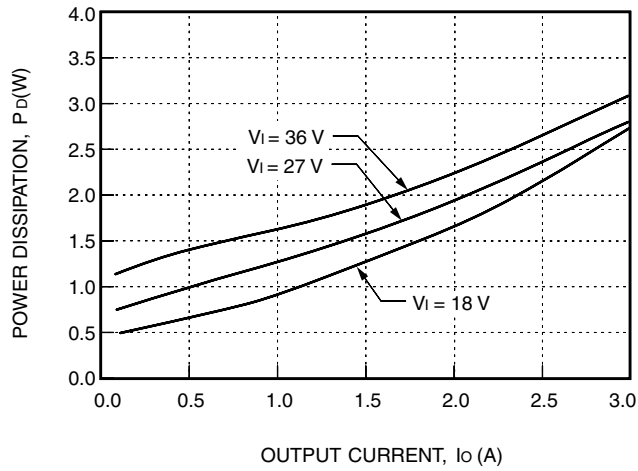

8-1809(C)

Figure 48. LC010D, 015D Typical Power Dissipation vs. Output Current at $T_c = 25^\circ\text{C}$

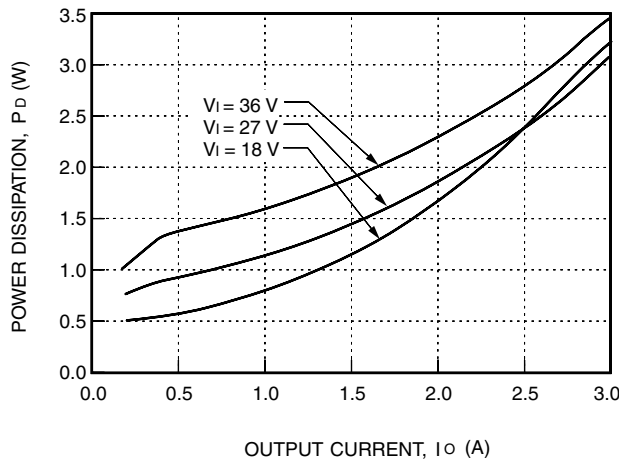

8-1810(C)

Note: The power dissipation of this unit is shown at $T_c = T_{c, \text{max}}$ because the efficiency of this power module drops at high temperatures.

Figure 49. LC015F Typical Power Dissipation vs. Output Current at Maximum Case Temperature

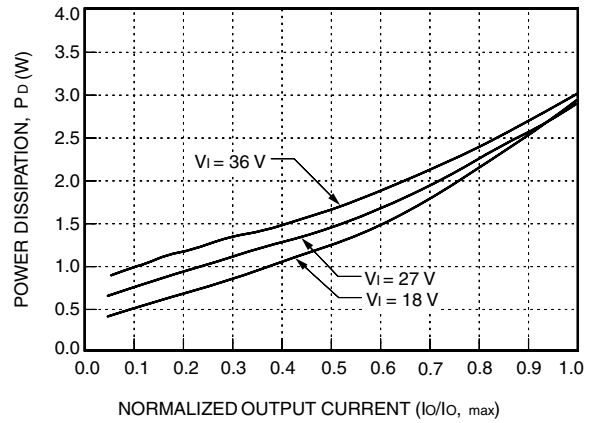

8-1811(C)

Figure 50. LC010A, B, C Typical Power Dissipation vs. Normalized Output Current at $T_c = 25^\circ\text{C}$

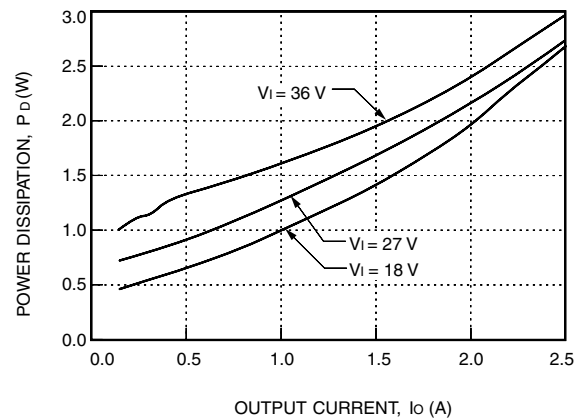

8-1812(C)

Figure 51. LC010F Typical Power Dissipation vs. Output Current at $T_c = 25^\circ\text{C}$

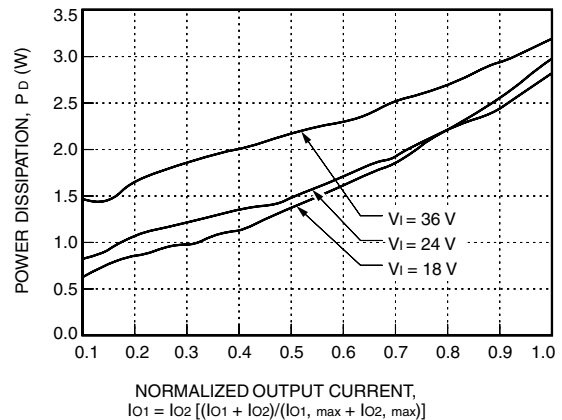

8-1813(C)

Figure 52. LC010AJ, BK, CL Typical Power Dissipation vs. Normalized Output Current at $T_c = 25^\circ\text{C}$

Thermal Considerations (continued)

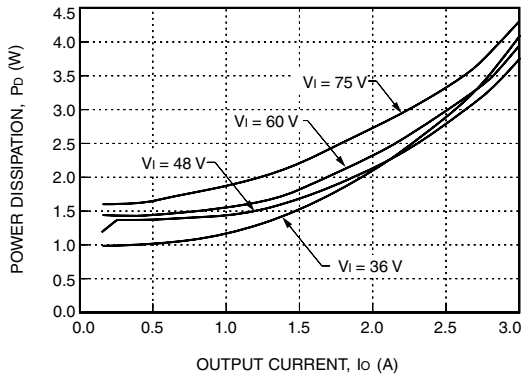

8-1383(C)

Note: The power dissipation of this unit is shown at $T_c = T_{c, max}$ because the efficiency of this power module drops at high temperatures.

Figure 53. LW015A Power Dissipation at Maximum Case Temperature

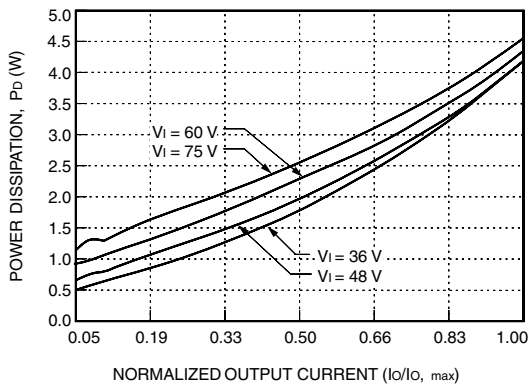

8-1814(C)

Figure 54. LW015B, C Typical Power Dissipation vs. Normalized Output Current at $T_c = 25\text{ }^\circ\text{C}$

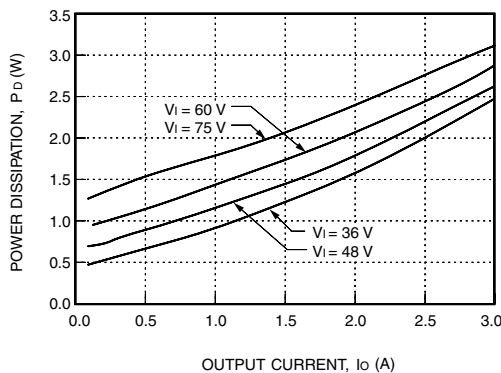

8-1815(C)

Figure 55. LW010D, LW015D Typical Power Dissipation vs. Output Current at $T_c = 25\text{ }^\circ\text{C}$

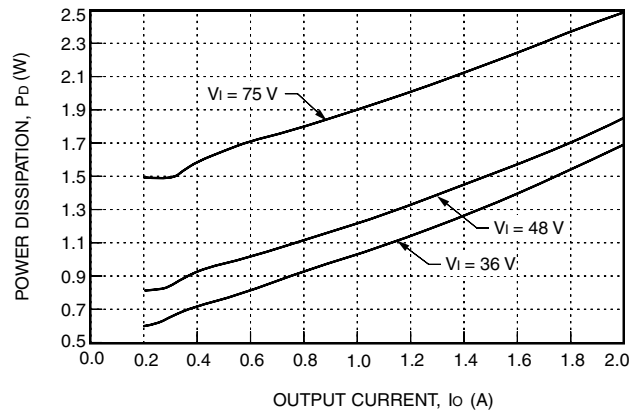

8-2109(C)

Figure 56. LW010D9 Typical Power Dissipation vs. Output Current at $T_c = 25\text{ }^\circ\text{C}$ with Output Voltage Trimmed Up to 2.5 V

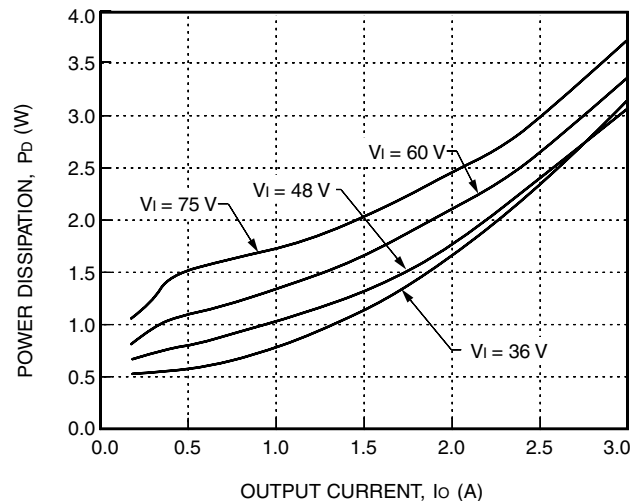

8-1385(C)

Note: The power dissipation of this unit is shown at $T_c = T_{c, max}$ because the efficiency of this power module drops at high temperatures.

Figure 57. LW015F Power Dissipation at Maximum Case Temperature

Thermal Considerations (continued)

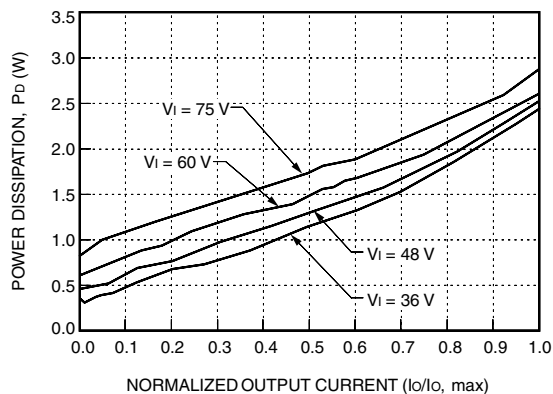

8-1380(C)

Figure 58. LW010A, B, C Typical Power Dissipation vs. Normalized Output Current at $T_c = 25\text{ }^\circ\text{C}$

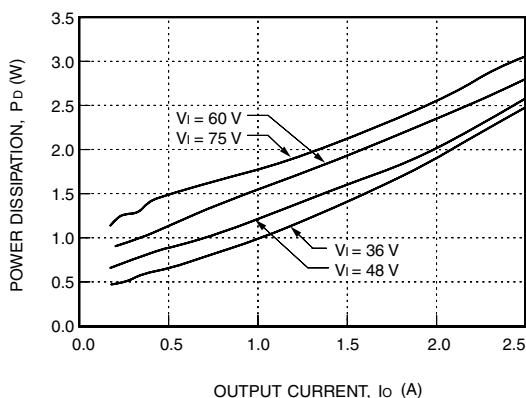

8-1816(C)

Figure 59. LW010F Typical Power Dissipation vs. Output Current at $T_c = 25\text{ }^\circ\text{C}$

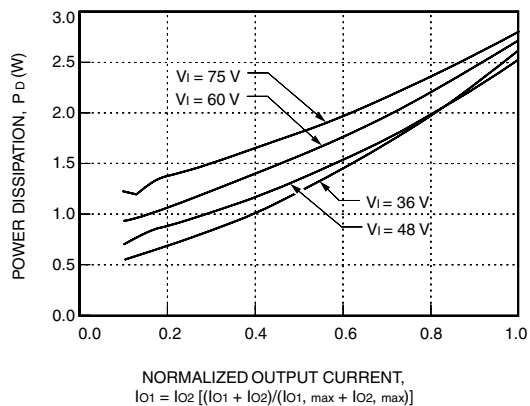

8-1817(C)

Figure 60. LW010AJ, BK, CL Typical Power Dissipation vs. Normalized Output Current at $T_c = 25\text{ }^\circ\text{C}$

Lineage Power

Module Derating

The derating curves in Figures 43 through 45 were determined by measurements obtained in an experimental apparatus shown in Figure 61. Note that the module and the printed-wiring board (PWB) that it is mounted on are both vertically oriented. The passage has a rectangular cross section.

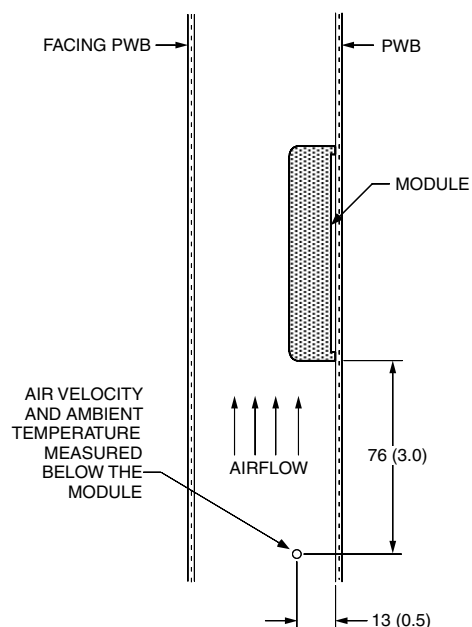

8-1126(C),d

Note: Dimensions are in millimeters and (inches).

Figure 61. Experimental Test Setup

Layout Considerations

Copper paths must not be routed beneath the power module standoffs.

Recommended Hole Pattern

Component-side footprint.

Dimensions are in millimeters and (inches).

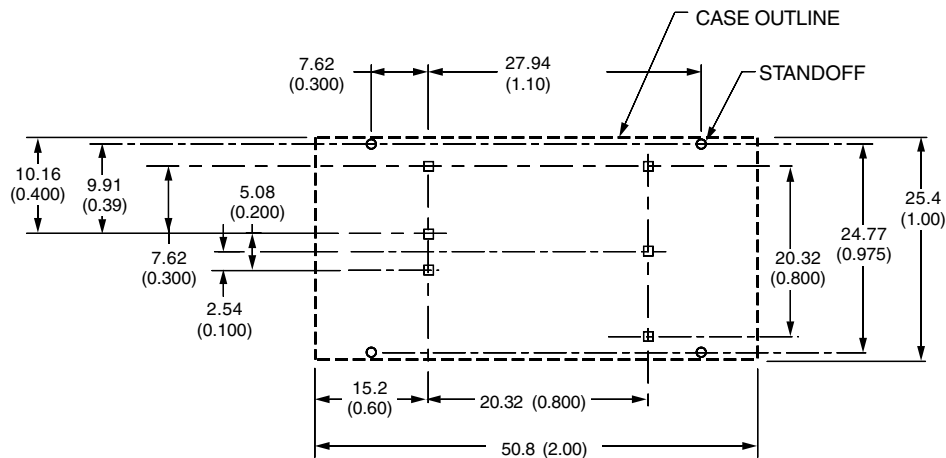

8-1329(C).b

Ordering Information

Table 6. Device Codes

Input Voltage	Output Voltage	Output Power	Device Code	Comcode
18 V—36 V	5 V	15 W	LC015A	107809550
18 V—36 V	12 V	15 W	LC015B	107983140
18 V—36 V	15 V	15 W	LC015C	TBD
36 V—75 V	2 V	6 W	LC015D	TBD
18 V—36 V	3.3 V	10 W	LC015F	107809543
18 V—36 V	5 V	10 W	LC010A	107747925
18 V—36 V	12 V	10 W	LC010B	107747933
18 V—36 V	15 V	10 W	LC010C	107747941
18 V—36 V	2 V	4 W	LC010D	107747958
18 V—36 V	3.3 V	8 W	LC010F	107747966
18 V—36 V	±5 V	15 W	LC010AJ	107987083
18 V—36 V	±12 V	15 W	LC010BK	107809592
18 V—36 V	±15 V	15 W	LC010CL	TBD
36 V—75 V	5 V	15 W	LW015A	107809527
36 V—75 V	12 V	15 W	LW015B	107935413
36 V—75 V	15 V	15 W	LW015C	107935421
36 V—75 V	2 V	6 W	LW015D	107809501
36 V—75 V	3.3 V	10 W	LW015F	107809535
36 V—75 V	5 V	10 W	LW010A	107747974
36 V—75 V	12 V	10 W	LW010B	107747982
36 V—75 V	15 V	10 W	LW010C	107747990
36 V—75 V	2 V	4 W	LW010D	107748006
36 V—75 V	3.3 V	8 W	LW010F	107748014
36 V—75 V	±5 V	10 W	LW010AJ	107935405
36 V—75 V	±12 V	10 W	LW010BK	107809568
36 V—75 V	±15 V	10 W	LW010CL	TBD

Ordering Information (continued)

Optional features may be ordered using the device code suffixes shown below. The feature suffixes are listed numerically in descending order. Please contact your Lineage Power Account Manager or Application Engineer for pricing and availability of options.

Table 7. Option Codes

Option	Device Code Suffix
Output voltage adjustment	9
Short pin: 2.8 mm ± 0.25 mm (0.110 in. ± 0.010 in.)	8
Short pin: 3.7 mm ± 0.25 mm (0.145 in. ± 0.010 in.)	6
Positive logic remote on/off	4
Synchronization (cannot be ordered on units with remote on/off)	3
Negative logic remote on/off	1



LINEAGE POWER

World Wide Headquarters

Lineage Power Corporation

3000 Skyline Drive, Mesquite, TX 75149, USA

+1-800-526-7819

(Outside U.S.A.: +1-972-284-2626)

www.lineagepower.com

e-mail: techsupport1@lineagepower.com

Asia-Pacific Headquarters

Tel: +65 641 6 4283

Europe, Middle-East and Africa Headquarters

Tel: +49 89 6089 286

India Headquarters

Tel: +91 80 28411633

Lineage Power reserves the right to make changes to the product(s) or information contained herein without notice. No liability is assumed as a result of their use or application. No rights under any patent accompany the sale of any such product(s) or information.

© 2008 Lineage Power Corporation, (Mesquite, Texas) All International Rights Reserved.