



Chipsmall Limited consists of a professional team with an average of over 10 year of expertise in the distribution of electronic components. Based in Hongkong, we have already established firm and mutual-benefit business relationships with customers from,Europe,America and south Asia,supplying obsolete and hard-to-find components to meet their specific needs.

With the principle of “Quality Parts,Customers Priority,Honest Operation,and Considerate Service”,our business mainly focus on the distribution of electronic components. Line cards we deal with include Microchip,ALPS,ROHM,Xilinx,Pulse,ON,Everlight and Freescale. Main products comprise IC,Modules,Potentiometer,IC Socket,Relay,Connector.Our parts cover such applications as commercial,industrial, and automotives areas.

We are looking forward to setting up business relationship with you and hope to provide you with the best service and solution. Let us make a better world for our industry!



Contact us

Tel: +86-755-8981 8866 Fax: +86-755-8427 6832

Email & Skype: info@chipsmall.com Web: www.chipsmall.com

Address: A1208, Overseas Decoration Building, #122 Zhenhua RD., Futian, Shenzhen, China



LC4H Counters

Timers/Time Switches/Counters/Hour Meters



LC4H Counters

**UL File No.: E122222
C-UL File No.: E122222**

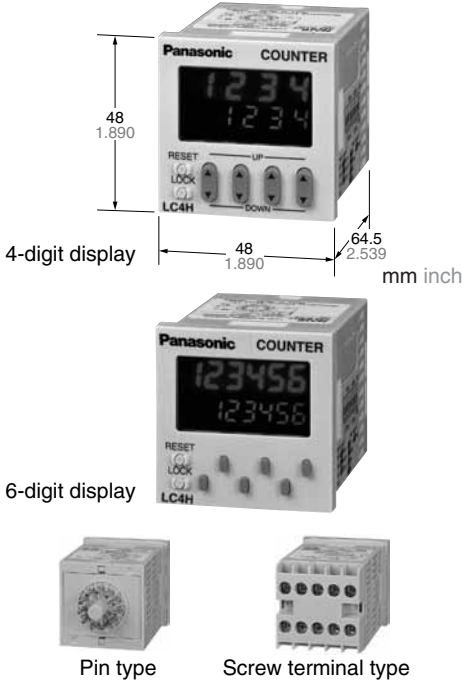

Features

- Bright and Easy-to-Read Display**
A brand new bright 2-color backlight LCD display. The easy-to-read screen in any location makes checking and setting procedures a cinch.
- Simple Operation**
Seesaw buttons make operating the unit even easier than before.
- Short Body of only 64.5 mm 2.539 inch (screw type) or 70.1 mm 2.760 inch (pin type)**
With a short body, it easily installs in even narrow control panels.
- Conforms to IP66's Weather Resistant Standards**
The water-proof panel keeps out water and dirt for reliable operation even in poor environments.

5. Screw terminal and Pin Type are Both Standard Options

The two terminal types are standard options to support either front panel installation or embedded installation.

6. Changeable Panel Cover

Also offers a black panel cover to meet your design considerations.

7. 4-digit or 6-digit display

Two sizes of displays are offered for you to choose the one that suits your needs.

8. Compliant with UL, c-UL and CE.

RoHS Directive compatibility information
<http://www.nais-e.com/>

Product types

Digit	Count speed	Output mode	Output	Operating voltage	Power down insurance	Terminal type	Part number	
4	30 Hz (cps)/ 5 KHz (Kcps) switchable	<ul style="list-style-type: none"> Maintain output/hold count Maintain output/over count I Maintain output/over count II One shot/over count One shot/recount I One shot/recount II One shot/hold count (7 modes) 	Relay (1c)	100 to 240 V AC	Available	8 pins	LC4H8-R4-AC240V	
						24 V AC	11 pins	LC4H-R4-AC240V
						12 to 24 V DC	Screw terminal	LC4H-R4-AC240VS
							8 pins	LC4H8-R4-AC24V
							11 pins	LC4H-R4-AC24V
							Screw terminal	LC4H-R4-AC24VS
						8 pins	LC4H8-R4-DC24V	
						11 pins	LC4H-R4-DC24V	
						Screw terminal	LC4H-R4-DC24VS	
						8 pins	LC4H8-T4-AC240V	
						11 pins	LC4H-T4-AC240V	
						Screw terminal	LC4H-T4-AC240VS	
6			Relay (1c)	100 to 240 V AC	Available	8 pins	LC4H8-R6-AC240V	
						24 V AC	11 pins	LC4H-R6-AC240V
						12 to 24 V DC	Screw terminal	LC4H-R6-AC240VS
							8 pins	LC4H8-R6-AC24V
							11 pins	LC4H-R6-AC24V
							Screw terminal	LC4H-R6-AC24VS
						8 pins	LC4H8-R6-DC24V	
						11 pins	LC4H-R6-DC24V	
						Screw terminal	LC4H-R6-DC24VS	
						8 pins	LC4H8-T6-AC240V	
						11 pins	LC4H-T6-AC240V	
						Screw terminal	LC4H-T6-AC240VS	
		8 pins	LC4H8-T6-AC24V					
		11 pins	LC4H-T6-AC24V					
		Screw terminal	LC4H-T6-AC24VS					
		8 pins	LC4H8-T6-DC24V					
		11 pins	LC4H-T6-DC24V					
		Screw terminal	LC4H-T6-DC24VS					

* A rubber gasket (ATC18002) and a mounting frame (AT8-DA4) are included.

LC4H-L Counters

UL File No.: E122222
C-UL File No.: E122222

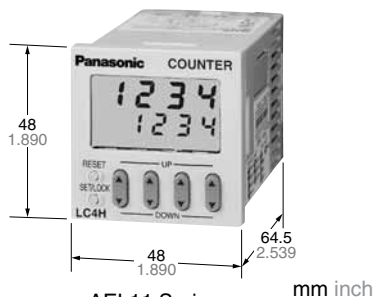

AEL11 Series
(4-digit display)



AEL13 Series
(6-digit display)



Pin type



Screw terminal type

Features

- 1. Low Price**
All this at an affordable price to provide you with unmatched cost performance.
- 2. Display is a bright reflective-type LCD.**
- 3. Inherits all of the characteristics of the LC4H digital timer.**
 - Seesaw switches ensure easy operation.
 - IP66 environmental protection.
 - Shortened body (pin type: 70.1 mm 2.760 inch, screw type: 64.5 mm 2.539 inch underhead).
- 4. Compliant with UL, c-UL and CE.**

Product types

Digit	Count speed	Output mode	Output	Operating voltage	Power down insurance	Terminal type	Part number				
4	30 Hz (cps)/ 5 KHz (Kcps) switchable	<ul style="list-style-type: none"> • Maintain output/hold count • Maintain output/over count I • Maintain output/over count II • One shot/over count • One shot/recount I • One shot/recount II • One shot/hold count (7 modes) 	Relay (1c)	100 to 240 V AC	Available	8 pins	LC4HL8-R4-AC240V				
				24 V AC/DC		11 pins	LC4HL-R4-AC240V				
				12 to 24 V DC		Screw terminal	LC4HL-R4-AC240VS				
			6	Relay (1c)		100 to 240 V AC	8 pins	LC4HL8-R4-AC24V			
						24 V AC/DC	11 pins	LC4HL-R4-AC24V			
						12 to 24 V DC	Screw terminal	LC4HL-R4-AC24VS			
Transistor (1a)				100 to 240 V AC		8 pins	LC4HL8-R4-DC24V				
				24 V AC/DC		11 pins	LC4HL-R4-DC24V				
				12 to 24 V DC		Screw terminal	LC4HL-R4-DC24VS				
6			30 Hz (cps)/ 5 KHz (Kcps) switchable	<ul style="list-style-type: none"> • Maintain output/hold count • Maintain output/over count I • Maintain output/over count II • One shot/over count • One shot/recount I • One shot/recount II • One shot/hold count (7 modes) 		Relay (1c)	100 to 240 V AC	Available	8 pins	LC4HL8-T4-AC240V	
							24 V AC/DC		11 pins	LC4HL-T4-AC240V	
							12 to 24 V DC		Screw terminal	LC4HL-T4-AC240VS	
	6	Relay (1c)			100 to 240 V AC	8 pins	LC4HL8-T4-AC24V				
					24 V AC/DC	11 pins	LC4HL-T4-AC24V				
					12 to 24 V DC	Screw terminal	LC4HL-T4-AC24VS				
		Transistor (1a)			100 to 240 V AC	8 pins	LC4HL8-T4-DC24V				
					24 V AC/DC	11 pins	LC4HL-T4-DC24V				
					12 to 24 V DC	Screw terminal	LC4HL-T4-DC24VS				
	6	30 Hz (cps)/ 5 KHz (Kcps) switchable			<ul style="list-style-type: none"> • Maintain output/hold count • Maintain output/over count I • Maintain output/over count II • One shot/over count • One shot/recount I • One shot/recount II • One shot/hold count (7 modes) 	Relay (1c)	100 to 240 V AC		Available	8 pins	LC4HL8-R6-AC240V
							24 V AC/DC			11 pins	LC4HL-R6-AC240V
							12 to 24 V DC			Screw terminal	LC4HL-R6-AC240VS
6			Relay (1c)	100 to 240 V AC		8 pins	LC4HL8-R6-AC24V				
				24 V AC/DC		11 pins	LC4HL-R6-AC24V				
				12 to 24 V DC		Screw terminal	LC4HL-R6-AC24VS				
			Transistor (1a)	100 to 240 V AC		8 pins	LC4HL8-R6-DC24V				
				24 V AC/DC		11 pins	LC4HL-R6-DC24V				
				12 to 24 V DC		Screw terminal	LC4HL-R6-DC24VS				
6			30 Hz (cps)/ 5 KHz (Kcps) switchable	<ul style="list-style-type: none"> • Maintain output/hold count • Maintain output/over count I • Maintain output/over count II • One shot/over count • One shot/recount I • One shot/recount II • One shot/hold count (7 modes) 		Relay (1c)	100 to 240 V AC	Available		8 pins	LC4HL8-T6-AC240V
							24 V AC/DC			11 pins	LC4HL-T6-AC240V
							12 to 24 V DC			Screw terminal	LC4HL-T6-AC240VS
	6	Relay (1c)			100 to 240 V AC	8 pins	LC4HL8-T6-AC24V				
					24 V AC/DC	11 pins	LC4HL-T6-AC24V				
					12 to 24 V DC	Screw terminal	LC4HL-T6-AC24VS				
		Transistor (1a)			100 to 240 V AC	8 pins	LC4HL8-T6-DC24V				
					24 V AC/DC	11 pins	LC4HL-T6-DC24V				
					12 to 24 V DC	Screw terminal	LC4HL-T6-DC24VS				

* A rubber gasket (ATC18002) and a mounting frame (AT8-DA4) are included.

Part names

• 4-digit display type

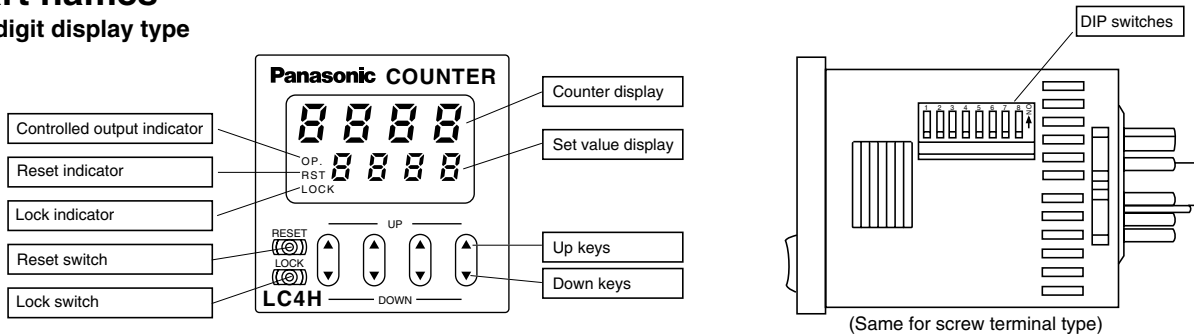

• 6-digit display type

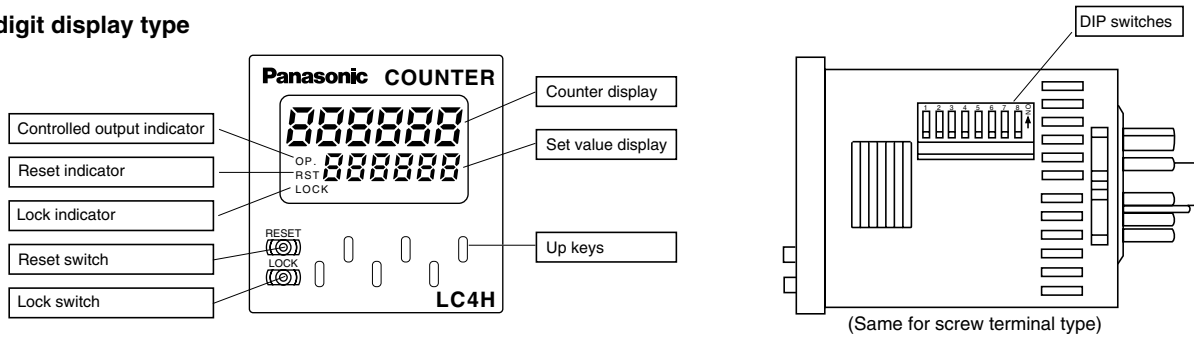

Specifications

Item		Relay output type		Transistor output type	
		AC type	DC type	AC type	DC type
Rating	Rated operating voltage	100 to 240 V AC, 24 V AC	12 to 24 V DC	100 to 240 V AC, 24 V AC	12 to 24 V DC
	Rated frequency	50/60 Hz common		50/60 Hz common	
	Rated power consumption	Max. 10 V A	Max. 3 W	Max. 10 V A	Max. 3 W
	Rated control capacity	5 A 250 V AC (resistive load)		100 mA 30 V DC	
	Input mode	Addition (UP)/Subtraction (DOWN)/Direction (DIR)/Individuality (IND)/Phase (PHASE) 5 modes selectable by DIP switch			
	Max. counting speed	30 Hz/5 kHz (selectable by DIP switch)			
	Counting input (Input 1, 2)	Min. input signal width: 16.7 ms at 30 Hz/0.1 ms at 5 kHz, ON time: OFF time = 1:1			
	Reset input	Min. input signal width: 1 ms, 20 ms (selected by DIP switch)			
	Lock input	Min. input signal width: 20 ms			
	Input signal	Contact or Open collector input/Input impedance: 1 kΩ or less, Input residual voltage: 2 V or less, Open impedance: 100 kΩ or more, Max. energized voltage: 40 V DC			
	Output mode	HOLD-A/HOLD-B/HOLD-C/SHOT-A/SHOT-B/SHOT-C/SHOT-D (7 modes selectable by DIP switch)			
	One shot output time	Approx. 1 s			
	Indication	7-segment LCD, Counter value (backlight red LED), Setting value (backlight yellow LED)			
	Digit	4-digit display type -999 to 9999 (-3 digits to +4 digits) (0 to 9999 for setting)			
6-digit display type -99999 to 999999 (-5 digits to 6 digits) (0 to 999999 for setting)					
Memory	EEP-ROM (Overwriting times: 10 ⁵ ope. or more)				
Contact	Contact arrangement	1 Form C		1 Form A (Open collector)	
	Initial contact resistance	100 mΩ (at 1 A 6 V DC)		—	
	Contact material	Ag alloy/Au flush		—	
Life	Mechanical (contact)	2 × 10 ⁷ ope. (Except for switch operation parts)		—	
	Electrical (contact)	10 ⁵ ope. (At rated control voltage)		10 ⁷ ope. (At rated control voltage)	
Electrical	Allowable operating voltage range	85 to 110 % of rated operating voltage			
	Break down voltage (Initial value)	Between live and dead metal parts: 2,000 Vrms for 1 min (11-pin type) Between input and output: 2,000 Vrms for 1 min Between open contacts: 1,000 Vrms for 1 min		Between live and dead metal parts: 2,000 Vrms for 1 min (11-pin type) Between input and output: 2,000 V AC for 1 min	
	Insulation resistance (At 500 V DC) (Initial value)	Between live and dead metal parts: Min. 100 MΩ (11-pin type) Between input and output: Min. 100 MΩ Between open contact: Min. 100 MΩ		Between live and dead metal parts: Min. 100 MΩ (11-pin type) Between input and output: Min. 100 MΩ	
	Temperature rise	Max. 65° C (under the flow of nominal operating current at nominal voltage)			
Mechanical	Vibration resistance	Functional	10 to 55 Hz (1 cycle/min), single amplitude: 0.35 mm (10 min on 3 axes)		
		Destructive	10 to 55 Hz (1 cycle/min), single amplitude: 0.75 mm (1 h on 3 axes)		
	Shock resistance	Functional	Min. 98 m 321.522 ft./s ² (4 times on 3 axes)		
		Destructive	Min. 294 m 964.567 ft./s ² (5 times on 3 axes)		
Operating conditions	Ambient temperature	-10° C to 55° C +14° F to +131° F			
	Ambient humidity	Max. 85 % RH (non-condensing)			
	Air pressure	860 to 1,060 h Pa			
	Ripple rate	—	20 % or less	—	20 % or less
Connection	8-pin/11-pin/screw terminal				
Protective construction	IP66 (front panel with a rubber gasket)				

LC4H/-L

Applicable standard

Safety standard	EN61812-1	Pollution Degree 2/Overvoltage Category II
EMC	(EMI)EN61000-6-4 Radiation interference electric field strength Noise terminal voltage (EMS)EN61000-6-2 Static discharge immunity	EN55011 Group1 ClassA EN55011 Group1 ClassA
	RF electromagnetic field immunity EFT/B immunity Surge immunity Conductivity noise immunity Power frequency magnetic field immunity Voltage dip/Instantaneous stop/Voltage fluctuation immunity	EN61000-4-2 4 kV contact 8 kV air EN61000-4-3 10 V/m AM modulation (80 MHz to 1 GHz) 10 V/m pulse modulation (895 MHz to 905 MHz) EN61000-4-4 2 kV (power supply line) 1 kV (signal line) EN61000-4-5 1 kV (power line) EN61000-4-6 10 V/m AM modulation (0.15 MHz to 80 MHz) EN61000-4-8 30 A/m (50 Hz) EN61000-4-11 10 ms, 30% (rated voltage) 100 ms, 60% (rated voltage) 1,000 ms, 60% (rated voltage) 5,000 ms, 95% (rated voltage)

Dimensions

mm inch

General tolerance: ± 1.0 ± 0.039

• 4-digit display type

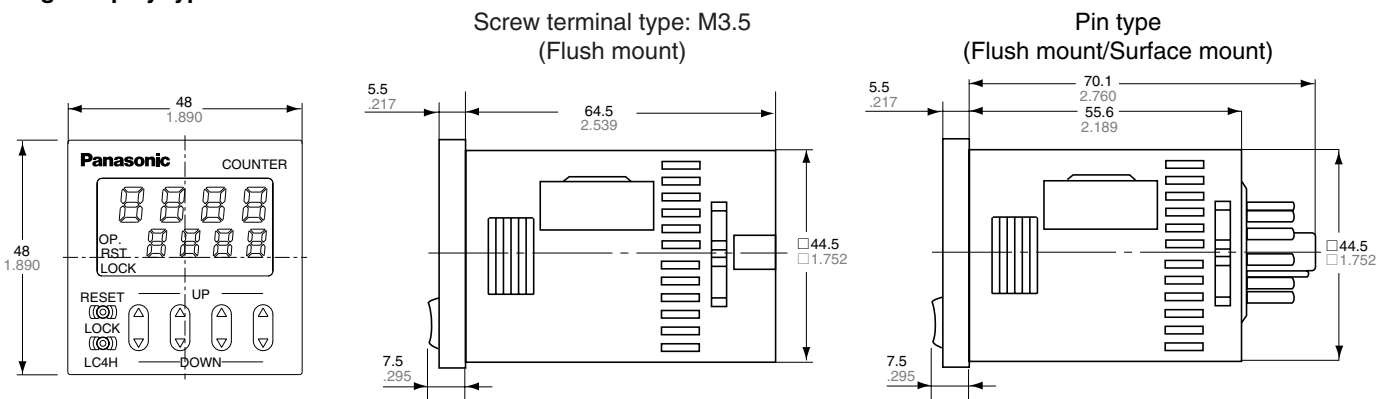

• 6-digit display type

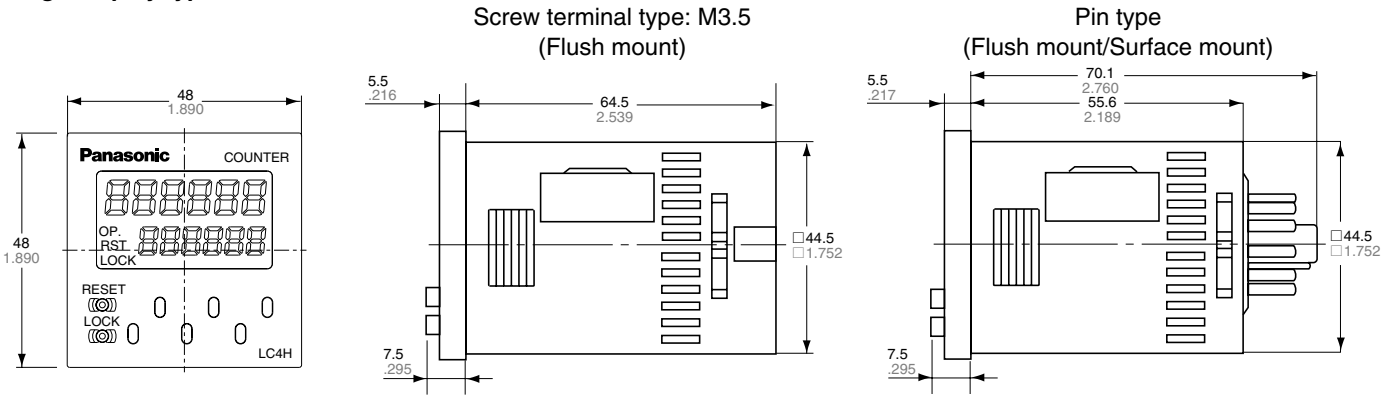

• Dimensions for flush mounting (with adapter installed)

Screw terminal type: M3.5

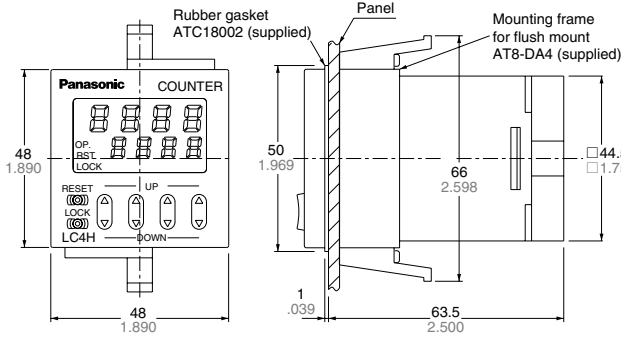

Pin type

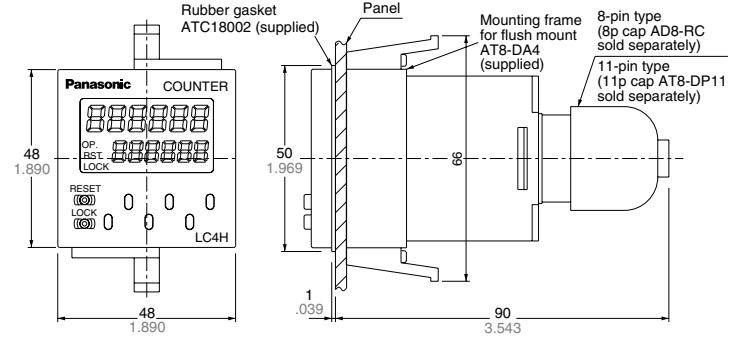

• Dimensions for front panel installations

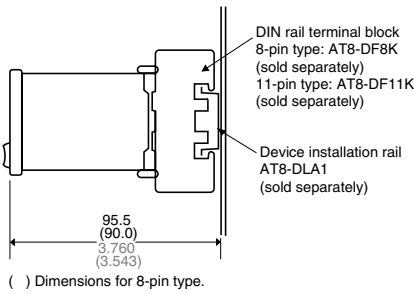

• Installation panel cut-out dimensions

The standard panel cut-out dimensions are shown below. Use the mounting frame (AT8-DA4) and rubber gasket (ATC18002).

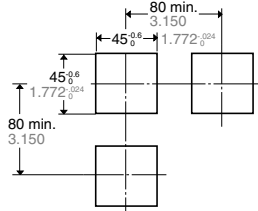

• For connected installations

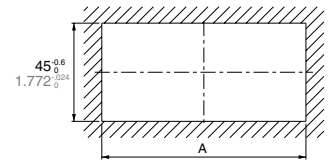

$$A = (48 \times n - 2.5) \cdot 0.6$$

Note 1: The installation panel thickness should be between 1 and 5 mm .039 and .197 inch.

Note 2: For connected installations, the waterproofing ability between the unit and installation panel is lost.

Terminal layouts and Wiring diagrams

• 8-pin type

Relay output type

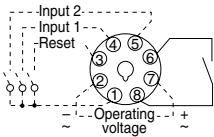

Transistor output type

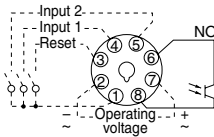

• 11-pin type

Relay output type

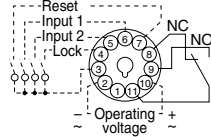

Transistor output type

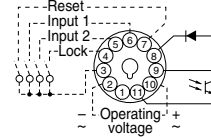

• Screw terminal type

Relay output type

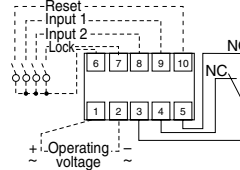

Transistor output type

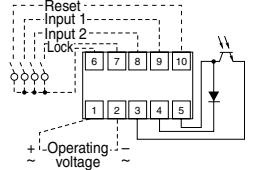

Note) For connecting the output leads of the transistor output type, refer to 5) Transistor output on page 141.

Setting the operation mode and set value

Setting procedure 1) Setting the operation mode (input mode and output mode)

Set the input and output modes with the DIP switches on the side of the counter.

DIP switches

	Item	DIP switch	
		OFF	ON
1	Output mode	Refer to table 1	
2			
3			
4	Minimum reset input signal width	20 ms	1 ms
5	Maximum counter speed	30 Hz	5 kHz
6	Input mode	Refer to table 2	
7			
8			

Table 1: Setting the output mode

DIP switch No.			Output mode
1	2	3	
ON	ON	ON	SHOT-A
OFF	OFF	OFF	SHOT-B
ON	OFF	OFF	SHOT-C
OFF	ON	OFF	SHOT-D
ON	ON	OFF	HOLD-A
OFF	OFF	ON	HOLD-B
ON	OFF	ON	HOLD-C
OFF	ON	ON	— (See note 1)

Table 2: Setting the input mode

DIP switch No.			Input mode
6	7	8	
ON	ON	ON	Addition input
OFF	OFF	OFF	Subtraction input
ON	OFF	OFF	Directive input
OFF	ON	OFF	Independent input
ON	ON	OFF	Phase input
OFF	OFF	ON	— (See note 1)
ON	OFF	ON	— (See note 1)
OFF	ON	ON	— (See note 1)

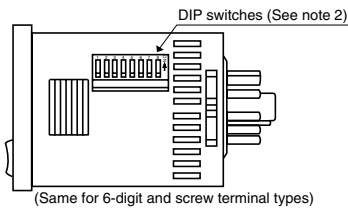

- Notes: 1) The counter and set value displays will display DIP Err.
 2) Set the DIP switches before installing the counter on the panel.
 3) When the DIP SW setting is changed, turn off the power once.
 4) The DIP switches are set as ON before shipping.

Setting procedure 2) Setting the set value

Set the set value with the UP and DOWN keys on the front of the counter.

Front display section

• 4-digit display type

- ① Counter display
 - ② Set value display
 - ③ Controlled output indicator
 - ④ Reset indicator
 - ⑤ Lock indicator
 - ⑥ UP keys
- Changes the corresponding digit of the set value in the addition direction (upwards).

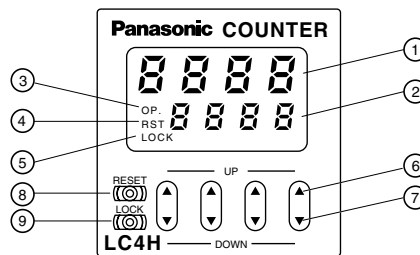

- ⑦ DOWN keys
- Changes the corresponding digit of the set value in the subtraction direction (downwards).
- ⑧ RESET switch
- Resets the counting value and the output.
- ⑨ LOCK switch
- Locks the operation of all keys on the counter.

• 6-digit display type

- ① Counter display
- ② Set value display
- ③ Controlled output indicator
- ④ Reset indicator
- ⑤ Lock indicator

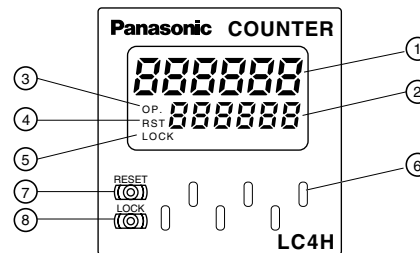

- ⑥ UP keys
- Changes the corresponding digit of the set value in the addition direction (upwards).
- ⑦ RESET switch
- Resets the counting value and the output.
- ⑧ LOCK switch
- Locks the operation of all keys on the counter.

• Changing the set value

1. It is possible to change the set value with the up and down keys (4-digit type only) even during counting. However, be aware of the following points.

1) If the set value is changed to less than the count value with counting set to the addition direction, counting will continue until it reaches full scale (9999 with the 4-digit type and 999999 with the 6-digit type), returns to zero, and then reaches the new set value. If the set value is changed to a value above the count value, counting will continue until the count value reaches the new set value.

2) Suppose that the counter is preset to count down. Whether a preset count-down value is smaller or larger than the count value, the counter counts down to "0(Zero)".

2. If the set value is changed to "0," the unit will not complete count-up. It starts counting up when the counting value comes to "0 (Zero)" again.

1) Up-count (addition) input when counting is set to the addition direction, counting will continue until full scale is reached (9999 with the 4-digit type and 999999 with the 6-digit type), return to zero, and then complete count-up.

2) Down-count (subtraction) input when counting is set to the subtraction direction, counting will continue until full scale is reached (-999 with the 4-digit type and -999999 with the 6-digit type), and then the display will change to - - - - with the 4-digit type and - - - - - with the 6-digit type. The counting value does not become "0" and so the counter does not count up.

3) For directive, independent, and phase input, when the counting value increases or decreases from the value "0" and then returns back to the value "0," count-up is completed.

Operation modes

1. Input mode

For the input mode, you can choose one of the following five modes

- Addition UP
- Subtraction DOWN
- Directive DIR
- Independent IND
- Phase PHASE

Input mode	Operation	*Minimum input signal width 30 Hz: 16.7 ms; 5 kHz: 0.1 ms
Addition UP	IN1 or IN2 works as an input block (gate) for the other input.	<p>• Example where IN1 is the counting input and IN2 is the input block (gate).</p> <p>IN1 IN2 Counting (addition) 0 1 2 3 --- n-3 n-2 n-1 n Counting (subtraction) n n-1 n-2 n-3 --- 3 2 1 0 Δ Reset Δ Count-up completed</p>
Subtraction DOWN		<p>• Example where IN2 is the counting input and IN1 is the input block (gate).</p> <p>IN1 IN2 Counting (addition) 0 1 2 3 4 --- n-1 n Counting (subtraction) n n-1 n-2 n-3 n-4 --- 1 0 Δ Reset Δ Count-up completed</p> <p>* "A" must be more than the minimum input signal width.</p>
Directive DIR	IN1 is the counting input and IN2 is the addition or subtraction directive input. IN2 adds at L level and subtracts at H level.	<p>IN1 IN2 Counting 0 1 2 3 4 3 2 1 0 1 2 3 4 Δ Reset</p> <p>* "A" must be more than the minimum input signal width.</p>
Independent IND	IN1 is addition input and IN2 is subtraction input.	<p>IN1 IN2 Counting 0 1 2 3 4 3 2 1 2 1 2 3 Δ Reset</p> <p>* IN1 and IN2 are completely independent, so there is no restriction on signal timing.</p>
Phase PHASE	Addition when the IN1 phase advances beyond IN2, and subtraction when the IN2 phase advances beyond IN1.	<p>IN1 IN2 Counting 0 1 2 3 2 1 0 Δ Reset</p> <p>* "B" must be more than the minimum input signal width.</p>

2. Output mode

For the output mode, you can choose one of the following seven modes

- Maintain output/hold count HOLD-A
- Maintain output/over count I HOLD-B
- Maintain output/over count II HOLD-C
- One shot/over count SHOT-A
- One shot/recount I SHOT-B
- One shot/recount II SHOT-C
- One shot/hold count SHOT-D

Output mode	Operation	(Example when input mode is either addition or subtraction)
Maintain output Hold count HOLD-A	Output control is maintained after count-up completion and until resetting. During that time, the count display does not change from that at count-up completion.	<p>* n: Set value</p>
Maintain output Over count I HOLD-B	Output control is maintained after count-up completion and until resetting. However, counting is possible despite completion of count-up.	<p>* n: Set value</p>
Maintain output Over count II HOLD-C	Output control is maintained after count-up completion and until the next signal enters. However, counting is possible despite completion of count-up.	<p>* n: Set value</p>
One shot Over count SHOT-A	Output control is maintained after count-up completion for a fixed time (approx. 1 sec). Counting is possible despite completion of count-up.	<p>* n: Set value</p>
One shot Recount I SHOT-B	Output control is maintained after count-up completion for a fixed time (approx. 1 sec). Counting is possible despite completion of count-up. However, reset occurs simultaneous with completion of count-up. While output is being maintained, restarting of the count is not possible	<p>* n: Set value</p>
One shot Recount II SHOT-C	Output control is maintained after count-up completion for a fixed time (approx. 1 sec). Counting is possible despite completion of count-up. However, reset occurs simultaneous with output OFF.	<p>* n: Set value</p>
One shot Hold count SHOT-D	Output control is maintained after count-up completion for a fixed time (approx. 1 sec). During that time, the count display does not change from that at count-up completion. Reset occurs simultaneous with output OFF.	<p>* n: Set value</p>



4-digit type



6-digit type



11 pin type



Screw terminal type

RoHS Directive compatibility information
<http://www.nais-e.com/>

UL File No.: E122222
C-UL File No.: E122222



Features

- Bright and Easy-to-Read Display**
A brand new bright 2-color backlight LCD display. The easy-to-read screen in any location makes checking and setting procedures a cinch.
- Easy to use, simple operation, simple settings**
 - Operation modes (input/output modes) can be set easily, using DIP switches on the side panel.
 - Values can be set easily, using key switches on the front panel.
- Pre-scaling function provided**
A pre-scaling function enables conversion of lengths and volumes to any desired values, and displays the results.
- Built-in power supply for high-capacitance sensor**
An internal power supply drives a 12 VDC, 100 mA high-capacitance sensor. (AC power supply types only)
Photoelectric switches, proximity switches and encoders can be directly connected.
- Dual-path AC sensor can be connected.**

- Basic insulation between the power supply and the input terminal (only for the sensor type model with power supply)**

There is no need for caution when connecting between terminals.

- Conforms to IP66's Weather Resistant Standards**

The water-proof panel keeps out water and dirt for reliable operation even in poor environments.

- 4-digit or 6-digit display**

Two sizes of displays are offered for you to choose the one that suits your needs.

- Screw terminal and Pin Type are Both Standard Options**

The two terminal types are standard options to support either front panel installation or embedded installation.

- Compliant with UL, c-UL and CE.**
- Low Price**

All this at an affordable price to provide you with unmatched cost performance.

Product types

Digit	Count speed	Operation mode	Output	Operation voltage	Power for sensor	Terminal	Part No.		
4	30 Hz/5 KHz switchable	<ul style="list-style-type: none"> • Maintain output/hold count • Maintain output/over count I • Maintain output/over count II • One shot/over count • One shot/recount I • One shot/recount II • One shot/hold count (7 modes) 	Relay	100 to 240 V AC	12 V DC 100mA	11 pins	LC4H-PS-R4-AC240V		
				Screw terminal		LC4H-PS-R4-AC240VS			
			Transistor	12 to 24 V DC /24 V AC	None	11 pins	LC4H-S-R4-24V		
				Screw terminal		LC4H-S-R4-24VS			
6					Relay	100 to 24 V AC	12 V DC 100mA	11 pins	LC4H-PS-R6-AC240V
						Screw terminal		LC4H-PS-R6-AC240VS	
					Transistor	12 to 24 V DC /24 V AC	None	11 pins	LC4H-S-R6-24V
						Screw terminal		LC4H-S-R6-24VS	
	Transistor	12 to 24 V DC /24 V AC			None	11 pins	LC4H-S-T6-24V		
		Screw terminal				LC4H-S-T6-24VS			

Notes) 1. Rubber packing (ATC18002) and an mounting frame (AT8-DA4) are included.
2. 100 to 240 VAC Tr outputs (11-pin terminal, screw-tightening terminal) types are also supported.

LC4H-S

Part names

• 4-digit display type

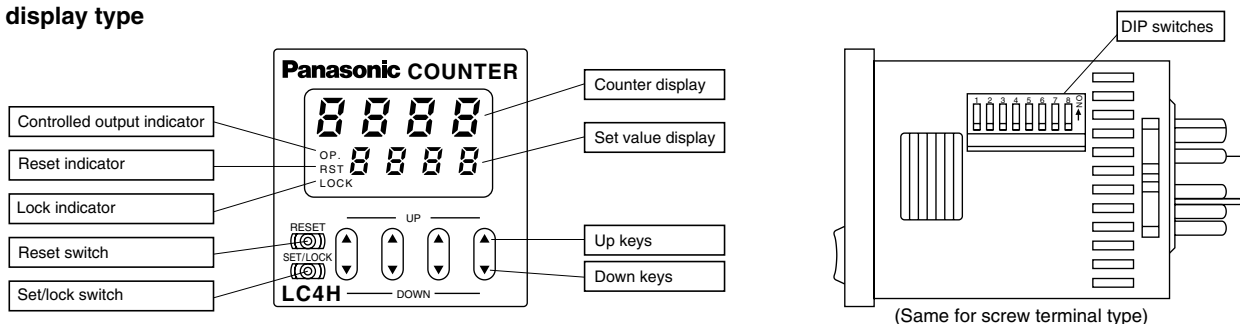

(Same for screw terminal type)

• 6-digit display type

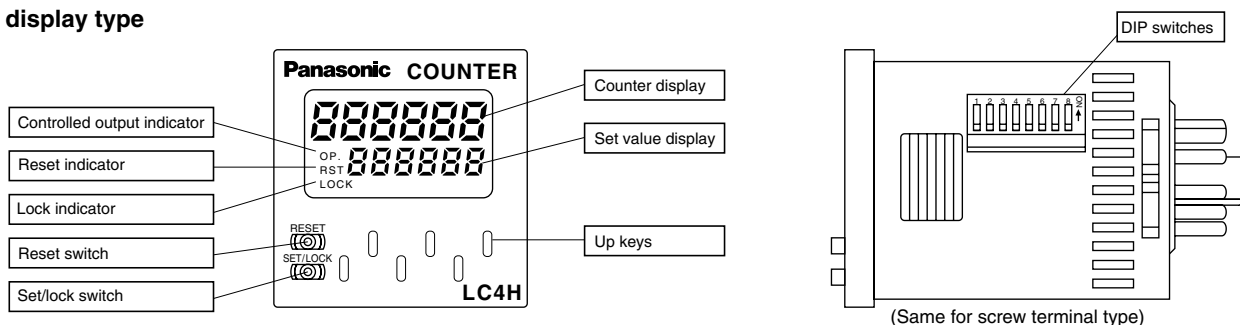

(Same for screw terminal type)

Specifications

Item		Relay output type		Transistor output type
		AC type	DC/AC type	DC/AC type
Rating	Rated operating voltage	100 to 240 V	12 to 24 V DC/24 V AC	12 to 24 V DC/24 V AC
	Rated frequency	50/60 Hz common		
	Rated power consumption	Max. 10 V A	Max. 3 W	
	Rated control capacity	5 A 250 V AC (resistive load)		100 mA, 30 V DC
	Input mode	Addition (UP)/Subtraction (DOWN)/Direction (DIR)/Individuality (IND)/Phase (PHASE) 5 modes selectable by DIP switches		
	Max. counting speed	30 Hz, 5 kHz (selectable by DIP switches)		
	Counting input (input 1, input 2)	16.7 ms at 30 Hz/0.1 ms at 5 kHz ON time: OFF time = 1:1		
	Reset input	Min. input signal width: 1 ms, 20 ms (selected by DIP switches)		
	Lock input	Min. input signal width: 20 ms		
	Input signal	Contact, Open collector input/DC two-wire system sensor Input impedance: 1 kΩ or less, Input residual voltage: 2 V or less, Open impedance: 100 kΩ or less, Max. energized voltage: 40 V DC		
	Output mode	HOLD-A, HOLD-B, HOLD-C, SHOT-A, SHOT-B, SHOT-C, SHOT-D, 7 modes selectable by DIP switches		
	One shot output time	1 s, 0.5s, 0.2s, 0.1s, 0.05, 0.01s		
	Indication	7-segment LCD, Counter value (backlight red LED), Setting value (backlight yellow LED)		
	Digit	4-digit display type -999 to 9999 (0 to 9999 for setting) 6-digit display type -99999 to 999999 (0 to 999999 for setting)		
	Decimal point	Can be set to three digits		
	Pre-scaling	0.001 to 9.999 (4-digit type), 0.001 to 99.999 (6-digit type)		
	Memory	EEP-ROM (Overwriting times: 10 ⁵ ope. or more)		
Power for senser	12 V DC (±10%) 100 mA Max.	—		
Contact	Contact arrangement	1 Form C		1 Form A (Open collector)
	Initial contact resistance	100 mΩ (at 1 A 6 V DC)		—
	Contact material	Ag alloy/Au flush		—
Life	Mechanical (contact)	2 × 10 ⁷ ope. (Except for switch operation parts)		—
	Electrical (contact)	10 ⁵ ope. (At rated control voltage)		10 ⁷ ope. (At rated control voltage)
Electrical	Operating voltage range	85 to 264 V AC	10.8 to 26.4 V DC, 20.4 to 26.4 V AC	
	Initial withstand voltage	Between live and dead metal parts: 2,000 Vrms for 1 min (pin type) Between input and output: 2,000 Vrms for 1 min		
	Initial insulation resistance (At 500 V DC)	Between live and dead metal parts: Min. 100 MΩ (pin type) Between input and output: Min. 100 MΩ		
	Temperature rise	Max. 65° C (under the flow of nominal operating current at nominal voltage)		
Mechanical	Vibration resistance	Functional	10 to 55 Hz (1 cycle/min), single amplitude: 0.35 mm (10 min on 3 axes)	
		Destructive	10 to 55 Hz (1 cycle/min), single amplitude: 0.75 mm (1 h on 3 axes)	
	Shock resistance	Functional	Min. 98 m/s ² (4 times on 3 axes)	
		Destructive	Min. 294 m/s ² (5 times on 3 axes)	
Operating conditions	Ambient temperature	-10° C to 55° C +14° F to +131° F		
	Ambient humidity	Max. 85 % RH (non-condensing)		
	Air pressure	860 to 1,060 h Pa		
Connection	11-pin/screw terminal			
Protective construction	IP66 (front panel with a rubber gasket)			

Applicable standard

Safety standard	EN61812-1	Pollution Degree 2/Overvoltage Category II
EMC	(EMI)EN61000-6-4 Radiation interference electric field strength Noise terminal voltage (EMS)EN61000-6-2 Static discharge immunity	EN55011 Group1 ClassA EN55011 Group1 ClassA
	RF electromagnetic field immunity EFT/B immunity Surge immunity Conductivity noise immunity Power frequency magnetic field immunity Voltage dip/Instantaneous stop/Voltage fluctuation immunity	EN61000-4-2 4 kV contact 8 kV air EN61000-4-3 10 V/m AM modulation (80 MHz to 1 GHz) 10 V/m pulse modulation (895 MHz to 905 MHz) EN61000-4-4 2 kV (power supply line) 1 kV (signal line) EN61000-4-5 1 kV (power line) EN61000-4-6 10 V/m AM modulation (0.15 MHz to 80 MHz) EN61000-4-8 30 A/m (50 Hz) EN61000-4-11 10 ms, 30% (rated voltage) 100 ms, 60% (rated voltage) 1,000 ms, 60% (rated voltage) 5,000 ms, 95% (rated voltage)

Dimensions

mm inch
General tolerance: ±1.0 ±.039

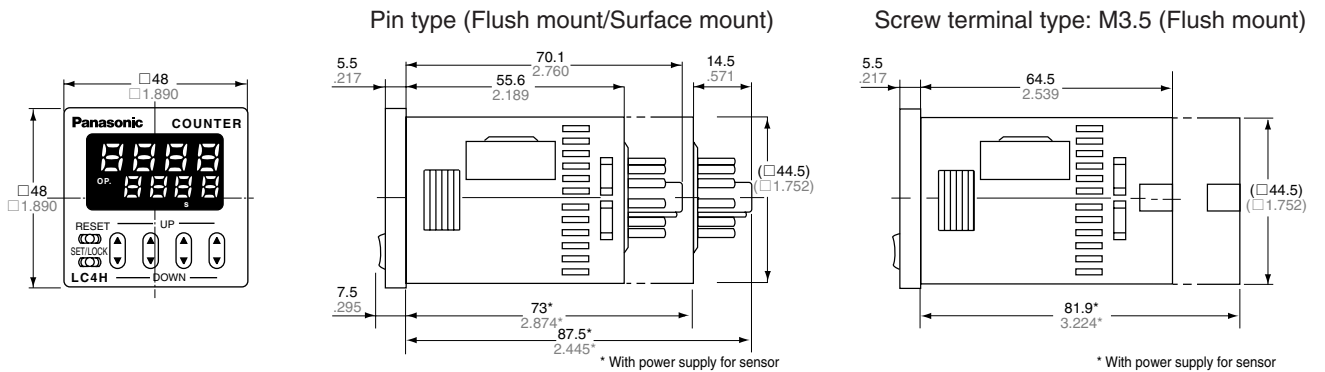

• Dimensions for flush mounting (with adapter installed)

Screw terminal type

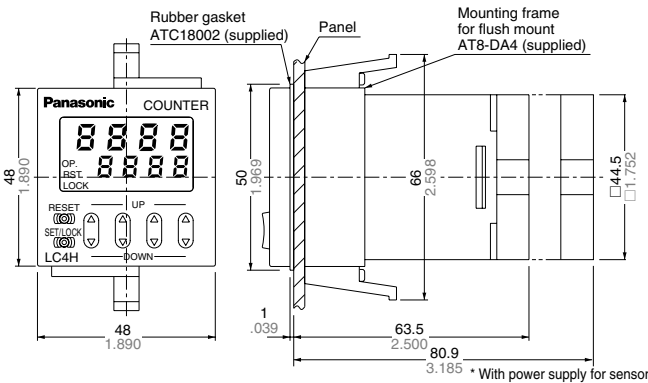

Pin type

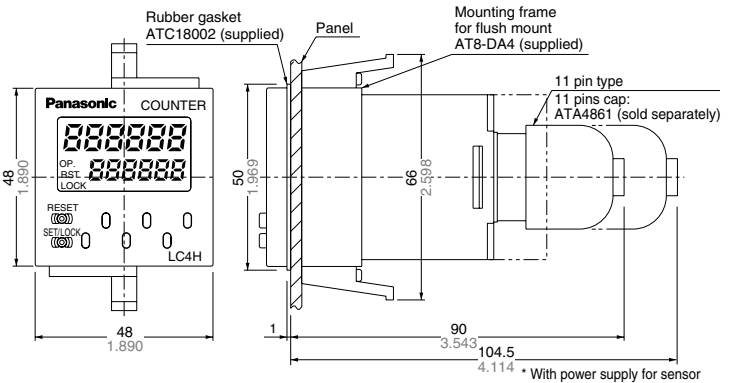

• Dimensions for front panel installations

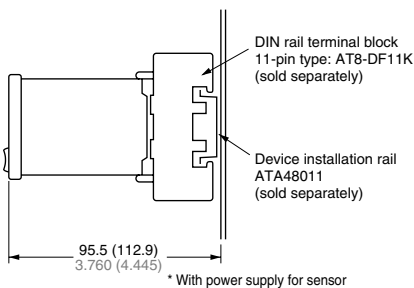

• Installation panel cut-out dimensions

The standard panel cut-out dimensions are shown below. Use the mounting frame (AT8-DA4) and rubber gasket (ATC18002).

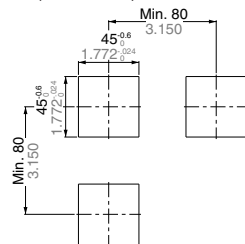

• For connected installations

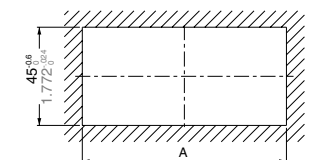

Note 1: The installation panel thickness should be between 1 and 5 mm .039 and .197 inch.
Note 2: For connected installations, the waterproofing ability between the unit and installation panel is lost.

Terminal layouts and Wiring diagrams

• Pin type

* With power supply for sensor

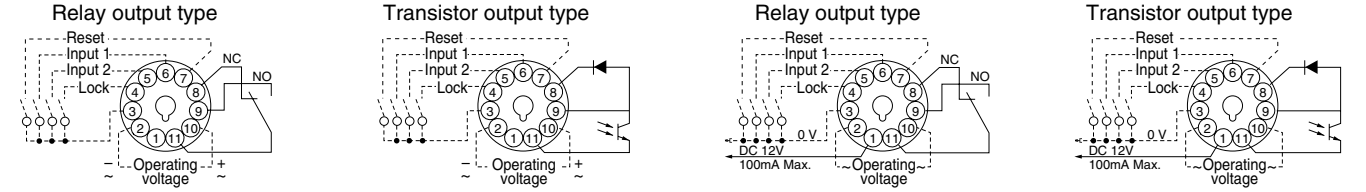

• Screw terminal type

* With power supply for sensor

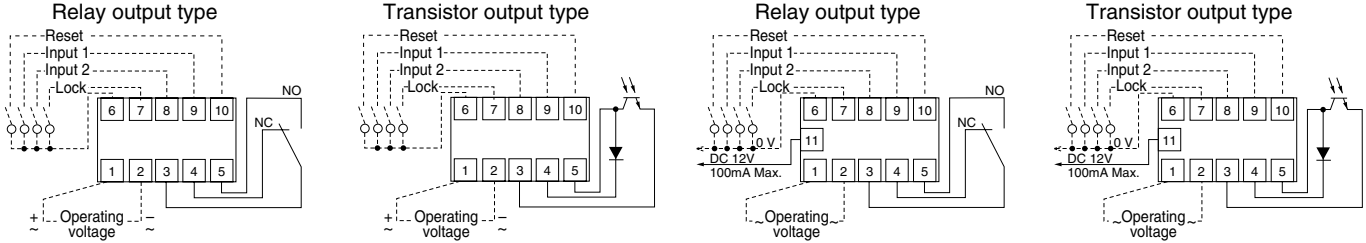

Note) For connecting the output leads of the transistor output type, refer to 5) Transistor output on page 141.

Setting the operation mode and counter

Setting procedure 1) Setting the operation mode (input mode and output mode)

Set the input and output modes with the DIP switches on the side of the counter.

DIP switches

Item	DIP switch		
	OFF	ON	
1	Refer to table 1		
2			
3			
4	Minimum reset input signal width	20 ms	1 ms
5	Maximum counter setting	30 Hz	5 kHz
6	Refer to table 2		
7			
8			

Table 1: Setting the output mode

DIP switch No.			Output mode
1	2	3	
ON	ON	ON	SHOT-A
OFF	OFF	OFF	SHOT-B
ON	OFF	OFF	SHOT-C
OFF	ON	OFF	SHOT-D
ON	ON	OFF	HOLD-A
OFF	OFF	ON	HOLD-B
ON	OFF	ON	HOLD-C
OFF	ON	ON	— (See note 1)

Table 2: Setting the input mode

DIP switch No.			Input mode
6	7	8	
ON	ON	ON	Addition input
OFF	OFF	OFF	Subtraction input
ON	OFF	OFF	Directive input
OFF	ON	OFF	Independent input
ON	ON	OFF	Phase input
OFF	OFF	ON	— (See note 1)
ON	OFF	ON	— (See note 1)
OFF	ON	ON	— (See note 1)

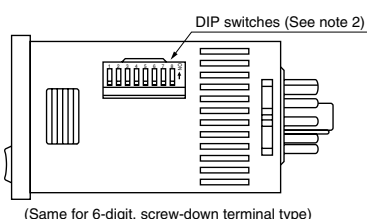

- Notes: 1) The counter and set value displays will display DIP Err.
 2) Set the DIP switches before installing the counter on the panel.
 3) When the DIP SW setting is changed, turn off the power once.
 4) The DIP switches are set as ON before shipping.

Setting procedure 2) Setting the set value

Set the set value with the UP and DOWN keys on the front of the counter.

Front display section

• 4-digit display type

- ① Counter display
 - ② Set value display
 - ③ Controlled output indicator
 - ④ Reset indicator
 - ⑤ Lock indicator
 - ⑥ UP keys
- Changes the corresponding digit of the set value in the addition direction (upwards)

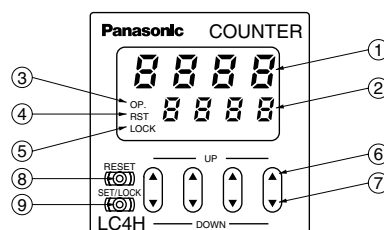

- ⑦ DOWN keys
- Changes the corresponding digit of the set value in the subtraction direction (downwards)
- ⑧ RESET switch
- Resets the counting value and the output
- ⑨ SET/LOCK switch
- This is used to handle pre-scaling values, one-shot times, decimal point position settings, and key lock operations (to disable Up key, Down key, and Reset key operations).

• 6-digit display type

- ① Counter display
- ② Set value display
- ③ Controlled output indicator
- ④ Reset indicator
- ⑤ Lock indicator

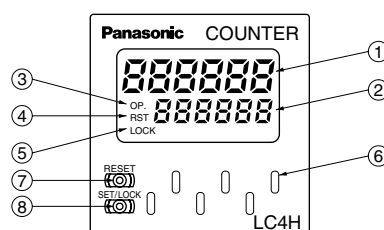

- ⑥ UP keys
- Changes the corresponding digit of the set value in the addition direction (upwards)
- ⑦ RESET switch
- Resets the counting value and the output
- ⑧ SET/LOCK switch
- This is used to handle pre-scaling values, one-shot times, decimal point position settings, and key lock operations (to disable Up key, Down key, and Reset key operations).

Setting procedure 3) Setting the input mode

The input mode is set using the key switch in the [Display] section on the front of the counter.

• Decimal point position setting mode

- ① Holding down the [SET/LOCK] key, press the key for the second digit to access the decimal point position setting mode.

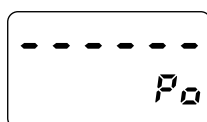

Example) 6-digit type
 Decimal point position setting mode display
 (Example shows default value displayed)

- ② When the setting mode has been accessed, release the [SET/LOCK] key.

- ③ The decimal point is set using the [UP] and [DOWN] keys to specify the 2nd, 3rd, and 4th digits (this applies only to 4-digit models). (The 1st digit is set using the [UP] key or [DOWN] key in settings where there is no decimal point (this applies only to 4-digit models).)

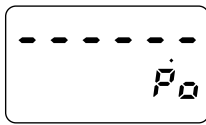

Example) 6-digit type
Example shows 2nd digit displayed using [UP] key

- ④ Press the [RESET] key to set the displayed decimal point position and return to normal operation.

• Setting the pre-scaling value

- ① Holding down the [SET/LOCK] key, press the key for the first digit to access the pre-scaling value setting mode.

Example) 4-digit type



Example) 6-digit type



Pre-scaling value setting mode displayed
(Example shows default values displayed)

- ② When the setting mode has been accessed, release the [SET/LOCK] key.
③ Use the [UP] or [DOWN] key to set the pre-scaling value (this applies only to 4-digit models).
Select either: 0.001 to 9.999 (4-digit) or 0.001 to 99.999 (6-digit)
④ Press the [RESET] key to set the displayed pre-scaling value and return to normal operation.

• Setting the one-shot output time

- ① Holding down the [SET/LOCK] key, press the key for the third digit to access the one-shot output time setting mode.

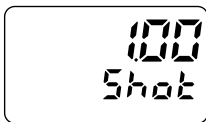

Example) 6-digit type
One-shot output time setting mode displayed
(Example shows default value displayed)

- ② When the setting mode has been accessed, release the [SET/LOCK] key.
③ Each time the 1st-digit [UP] key is pressed, the one-shot output time changes in the following sequence, moving to the right:

→ 1 s → 0.5 s → 0.2 s → 0.1 s → 0.05 s → 0.01 s →

(With a 4-digit type, the [DOWN] key can also be used to move to the left.)

- ④ Press the [RESET] key to set the displayed one-shot output time and return to normal operation.

Changing the set value

1. It is possible to change the set value with the up and down keys (4-digit type only) even during counting. However, be aware of the following points.

1) If the set value is changed to less than the count value with counting set to the addition direction, counting will continue until it reaches full scale (9999 with the 4-digit type and 999999 with the 6-digit type), returns to zero, and then reaches the new set value. If the set value is changed to a value above the count value, counting will continue until the count value reaches the new set value.

2) Suppose that the counter is preset to count down. Whether a preset count-down value is smaller or larger than the count value, the counter counts down to "0 (zero)".

2. If the set value is changed to "0," the unit will not complete count-up. It starts counting up when the counting value comes to "0 (zero)" again.

1) Up-count (addition) input
When counting is set to the addition direction, counting will continue until full scale is reached (9999 with the 4-digit type and 999999 with the 6-digit type), return to zero, and then complete count-up.

2) Down-count (subtraction) input
When counting is set to the subtraction direction, counting will continue until full scale is reached (-999 with the 4-digit type and -99999 with the 6-digit type), and then the display will change to "-----" with the 4-digit type and "-----" with the 6-digit type.

The counting value does not become "0 (zero)" and so the counter does not count up.

3) Directive, independent, and phase inputs

The counting value is counted up or down to any number other than "0" once. When it comes to "0 (zero)" again, the counter starts counting up.

CAUTIONS FOR USE

For more information regarding the cautions for use of LC4H series counter, refer to page 140 "PRECAUTIONS IN USING THE LC4H SERIES".

Operation mode

1. Input mode

For the input mode, you can choose one of the following five modes

- Addition UP
- Subtraction DOWN
- Directive DIR
- Independent IND
- Phase PHASE

Input mode	Operation	*Minimum input signal width 30 Hz: 16.7 ms; 5 kHz: 0.1 ms
Addition <input type="checkbox"/> UP	IN1 or IN2 works as an input block (gate) for the other input.	<p>• Example where IN1 is the counting input and IN2 is the input block (gate).</p>
Subtraction <input type="checkbox"/> DOWN		<p>• Example where IN2 is the counting input and IN1 is the input block (gate).</p> <p>* "A" must be more than the minimum input signal width.</p>
Directive <input type="checkbox"/> DIR	IN1 is the counting input and IN2 is the addition or subtraction directive input. IN2 adds at L level and subtracts at H level.	<p>* "A" must be more than the minimum input signal width.</p>
Independent <input type="checkbox"/> IND	IN1 is addition input and IN2 is subtraction input.	<p>* IN1 and IN2 are completely independent, so there is no restriction on signal timing.</p>
Phase <input type="checkbox"/> PHASE	Addition when the IN1 phase advances beyond IN2, and subtraction when the IN2 phase advances beyond IN1.	<p>* "B" must be more than the minimum input signal width.</p>

2. Output mode

For the output mode, you can choose one of the following seven modes

- Maintain output/hold count HOLD-A
- Maintain output/over count I HOLD-B
- Maintain output/over count II HOLD-C
- One shot/over count SHOT-A
- One shot/recount I SHOT-B
- One shot/recount II SHOT-C
- One shot/hold count SHOT-D

Output mode	Operation	(Example when input mode is either addition or subtraction)
Maintain output Hold count HOLD-A	Output control is maintained after count-up completion and until resetting. During that time, the count display does not change from that at count-up completion.	<p>* n: Set value</p>
Maintain output Over count I HOLD-B	Output control is maintained after count-up completion and until resetting. However, counting is possible despite completion of count-up.	<p>* n: Set value</p>
Maintain output Over count II HOLD-C	Output control is maintained after count-up completion and until the next signal enters. However, counting is possible despite completion of count-up.	<p>* n: Set value</p>
One shot Over count SHOT-A	Output control is maintained after count-up completion for one shot output time. Counting is possible despite completion of count-up.	<p>* n: Set value</p>
One shot Recount I SHOT-B	Output control is maintained after count-up completion for one shot output time. Counting is possible despite completion of count-up. However, reset occurs simultaneous with completion of count-up. While output is being maintained, restarting of the count is not possible	<p>* n: Set value</p>
One shot Recount II SHOT-C	Output control is maintained after count-up completion for one shot output time. Counting is possible despite completion of count-up. However, reset occurs simultaneous with output OFF.	<p>* n: Set value</p>
One shot Hold count SHOT-D	Output control is maintained after count-up completion for one shot output time. During that time, the count display does not change from that at count-up completion. Reset occurs simultaneous with output OFF.	<p>* n: Set value</p>

Input connections

• Signal input type

1) Open collector

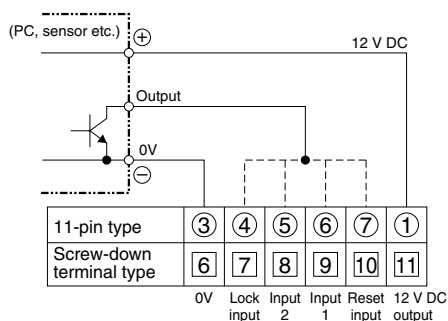

2) For voltage output

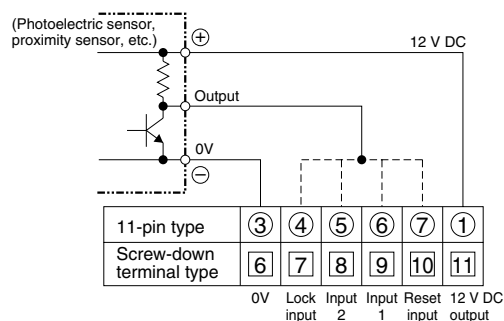

3) Contact input

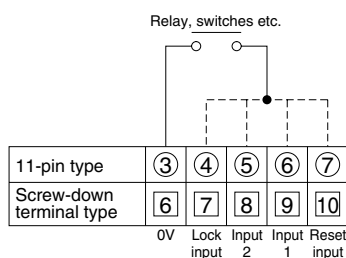

4) For a rotary encoder

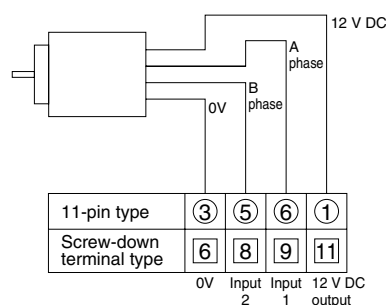

Input 1, input 2, and reset input specifications

- Impedance during short-circuit: 1 kΩ max. (At 0 Ω, the outflow current is approximately 12 mA.)
- Residual voltage during short-circuit: 2 V max.
- Impedance when released: 100 kΩ min.
- Max. applied voltage: 40 VDC max.

Lock input specifications

- Impedance during short-circuit: 1 kΩ max. (At 0 Ω, the outflow current is approximately 1.5 mA.)
- Residual voltage during short-circuit: 2 V max.
- Impedance when released: 100 kΩ min.
- Max. applied voltage: 40 DVC max.
- The contact relay should be one which can open/close 5 V, 1.5 mA.

* There is no 12 V DC with 12 - 24 V DC/24 V AC types.

5) For a dual-line sensor

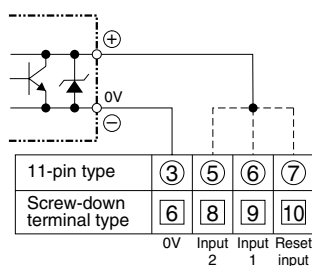

Dual-line sensor specifications

- Leakage current: 1.5 mA max.
- Breaker capacitance: 5 mA min.
- Residual voltage: 3.0 V max.
- Usable voltage: Runs on 10 VDC

* If a dual-line sensor is connected to a 12 - 24 VDC/24 VAC type, 24 VDC (21.6 to 26.4 VDC) and 24 VAC (21.6 to 26.4 VAC) should be applied to the power supply voltage of the counter.

What is the prescale function?

The prescale function converts the count into an actual value (amount) and displays it.

Example

For a device that outputs 500 pulses when 1 m has been fed:

1. Set decimal position to the last 3rd place.
2. Set the prescale value to 0.002 (1/500).

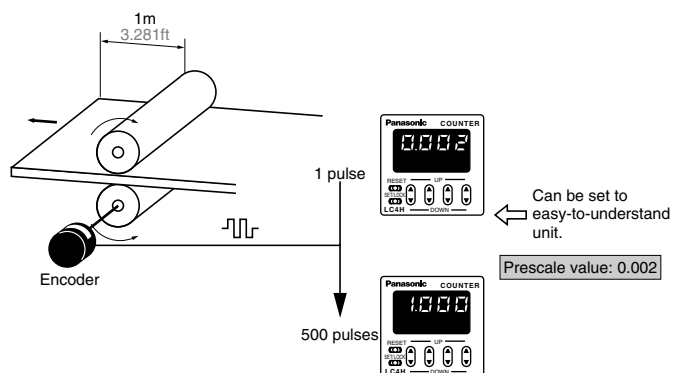

UL File No.: E122222
C-UL File No.: E122222



Features

1. Two-stage presetting (upper and lower limits)

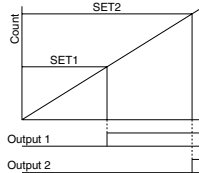

2. Bright and Easy-to-Read Display

A brand new bright 2-color backlight LCD display. The easy-to-read screen in any location makes checking and setting procedures a cinch.

3. Simple Operation

Seesaw buttons make operating the unit even easier than before.

4. Short Body of only 64.5 mm 2.539 inch (screw type) or 70.1 mm 2.760 inch (pin type)

With a short body, it easily installs in even narrow control panels.

5. Conforms to IP66's Weather Resistant Standards

The water-proof panel keeps out water and dirt for reliable operation even in poor environments.

6. Screw terminal and Pin Type are Both Standard Options

The two terminal types are standard options to support either front panel installation or embedded installation.

7. Changeable Panel Cover

Also offers a black panel cover to meet your design considerations.

8. Compliant with UL, c-UL and CE.

9. Low Price

All this at an affordable price to provide you with unmatched cost performance.

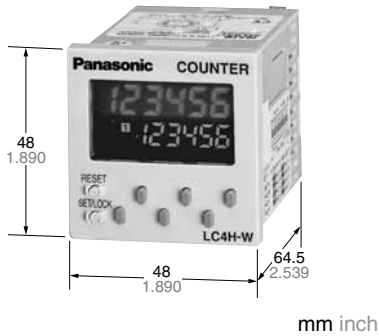

11-pin type



Screw terminal type

RoHS Directive compatibility information
<http://www.nais-e.com/>

Product types

Digit	Count speed	Output mode		Output	Operating voltage	Power down insurance	Terminal type	Part number
		Output 1	Output 2					
6	30 Hz (cps)/ 5 KHz (Kcps) switchable	<ul style="list-style-type: none"> Maintain output/over count I Maintain output/over count II Maintain output/over count III One shot/over count (4 modes) 	<ul style="list-style-type: none"> Maintain output/hold count Maintain output/over count I Maintain output/over count II Maintain output/over count III One shot/over count One shot/recount I One shot/recount II One shot/hold count (8 modes) 	Relay (1a+1a)	100 to 240 V AC	Available	11 pins	LC4H-W-R6-AC240V
					24V AC		Screw terminal	LC4H-W-R6-AC240VS
					12 to 24 V DC		11 pins	LC4H-W-R6-AC24V
							Screw terminal	LC4H-W-R6-AC24VS
					100 to 240 V AC		11 pins	LC4H-W-R6-DC24V
							Screw terminal	LC4H-W-R6-DC24VS
				Transistor (1a+1a)	100 to 240 V AC		11 pins	LC4H-W-T6-AC240V
					24V AC		Screw terminal	LC4H-W-T6-AC240VS
					12 to 24 V DC		11 pins	LC4H-W-T6-AC24V
							Screw terminal	LC4H-W-T6-AC24VS
					11 pins		LC4H-W-T6-DC24V	
					Screw terminal		LC4H-W-T6-DC24VS	

* A rubber gasket (ATC18002) and a mounting frame (AT8-DA4) are included.

Part names

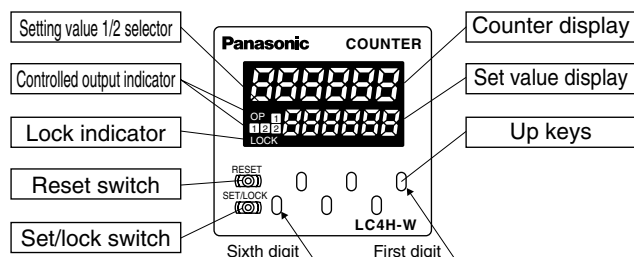

UP keys : Used to set the corresponding digits for the count-up mode.

RESET key : Used to reset counting and its output.

SET/LOCK key : Used to select between the Setting 1 display and Setting 2 display and to lock the keys (UP and RESET keys not responsive to touch). Used also to set and confirm the input mode.

Specifications

Item		Relay output type		Transistor output type	
		AC type	DC type	AC type	DC type
Rating	Rated operating voltage	100 to 240 V AC 24 V AC	12 to 24 V DC	100 to 240 V AC 24 V AC	12 to 24 V DC
	Rated frequency	50/60 Hz common	—	50/60 Hz common	—
	Rated power consumption	Max. 10 V A	Max. 3 W	Max. 10 V A	Max. 3 W
	Rated control capacity	3 A, 250 V AC (resistive load)		100 mA, 30 V DC	
	Input mode	Addition (UP)/Subtraction (DOWN)/Direction (DIR)/Individuality (IND)/Phase (PHASE) (5 modes selectable by DIP switch)			
	Counting speed	30 Hz(cps)/5 KHz(cps) (selectable by DIP switch)			
	Counting input (Input 1, 2)	Min. input signal width: 16.7 ms at 30 Hz(cps)/0.1 ms at 5 KHz(cps) ON time: OFF time = 1:1			
	Reset input	Min. input signal width: 1 ms, 20 ms (selected by DIP switch)			
	Input signal	Contact or Open collector input/Input impedance: 1 kΩ or less, Input residual voltage: 2 V or less, Open impedance: 100 kΩ or more, Max. energized voltage: 40 V DC			
	Output mode	Output 1. HOLD-B, C, D SHOT-A (4 modes) Output 2. HOLD-A, B, C SHOT-A, B, C, D (8 modes) (selectable by DIP switch)			
	One shot output time	Approx. 1 s			
	Indication	7-segment LCD, Counter value (backlight red LED), Setting value (backlight yellow LED)			
	Digit	-99999 to 999999 (-5 digits to 6 digits) (0 to 999999 for setting)			
	Memory	EEP-ROM (Overwriting times: 10 ⁵ ope. or more)			
Contact	Contact arrangement	1 Form A + 1 Form A		1 Form A + 1 Form A (Open collector)	
	Contact resistance (Initial value)	100 mΩ (at 1 A 6 V DC)		—	
	Contact material	Ag alloy/Au flush		—	
Life	Mechanical (contact)	Min. 2 × 10 ⁷ ope.		—	
	Electrical (contact)	Min. 10 ⁵ ope. (At rated control voltage)		Min. 10 ⁷ ope. (At rated control voltage)	
Electrical	Allowable operating voltage range	85 to 110 % of rated operating voltage			
	Break down voltage (Initial value)	Between live and dead metal parts: 2,000 Vrms for 1 min (pin type) Between input and output: 2,000 Vrms for 1 min Between open contacts: 1,000 Vrms for 1 min		Between live and dead metal parts: 2,000 Vrms for 1 min Between input and output: 2,000 V AC for 1 min	
	Insulation resistance (At 500 V DC) (Initial value)	Between live and dead metal parts: Min. 100 MΩ (pin type) Between input and output: Min. 100 MΩ Between open contact: Min. 100 MΩ		Between live and dead metal parts: Min. 100 MΩ (pin type) Between input and output: Min. 100 MΩ	
	Temperature rise	Max. 65°C (under the flow of nominal operating current at nominal voltage)		—	
Mechanical	Vibration resistance	Functional	10 to 55 Hz (1 cycle/min), single amplitude: 0.35 mm (10 min on 3 axes)		
		Destructive	10 to 55 Hz (1 cycle/min), single amplitude: 0.75 mm (1 h on 3 axes)		
	Shock resistance	Functional	Min. 98 m/s ² (4 times on 3 axes)		
		Destructive	Min. 294 m/s ² (5 times on 3 axes)		
Operating conditions	Ambient temperature	-10°C to 55°C +14°F to +131°F			
	Ambient humidity	Max. 85 % RH (non-condensing)			
	Air pressure	860 to 1,060 h Pa			
	Ripple rate	—	20 % or less	—	20 % or less
Connection	11-pin/screw terminal				
Protective construction	IP66 (front panel with a rubber gasket)				

Applicable standard

Safety standard	EN61812-1	Pollution Degree 2/Overvoltage Category II
EMC	(EMI)EN61000-6-4 Radiation interference electric field strength Noise terminal voltage (EMS)EN61000-6-2 Static discharge immunity	EN55011 Group1 ClassA EN55011 Group1 ClassA
	RF electromagnetic field immunity	EN61000-4-2 4 kV contact 8 kV air
	EFT/B immunity	EN61000-4-3 10 V/m AM modulation (80 MHz to 1 GHz) 10 V/m pulse modulation (895 MHz to 905 MHz)
	Surge immunity	EN61000-4-4 2 kV (power supply line) 1 kV (signal line)
	Conductivity noise immunity	EN61000-4-5 1 kV (power line)
	Power frequency magnetic field immunity	EN61000-4-6 10 V/m AM modulation (0.15 MHz to 80 MHz)
	Voltage dip/Instantaneous stop/Voltage fluctuation immunity	EN61000-4-8 30 A/m (50 Hz) EN61000-4-11 10 ms, 30% (rated voltage) 100 ms, 60% (rated voltage) 1,000 ms, 60% (rated voltage) 5,000 ms, 95% (rated voltage)

LC4H-W

Dimensions

• LC4H-W electrical counter

mm inch
General tolerance: $\pm 1.0 \pm .039$

Screw terminal type (Flush mount): M3.5

Pin type (Flush mount/Surface mount)

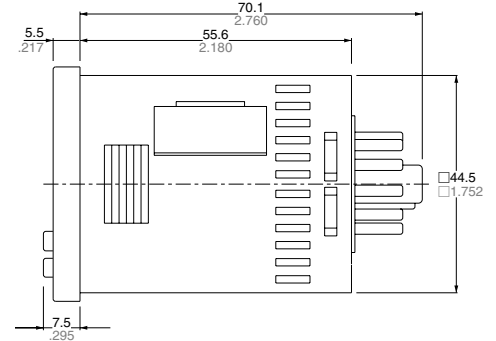
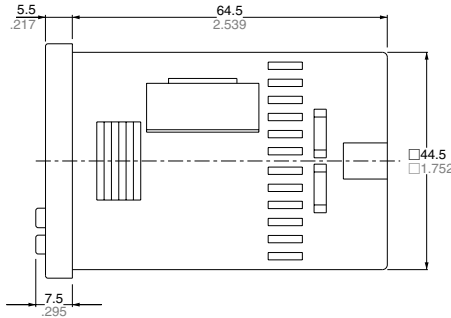
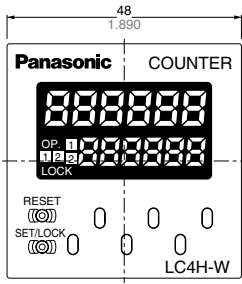

• Dimensions for flush mounting (with adapter installed)

Screw terminal type

Pin type

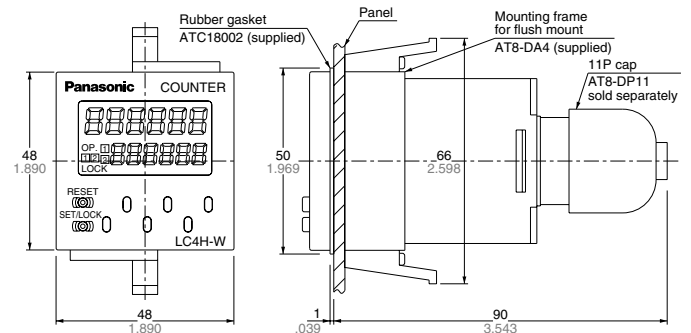
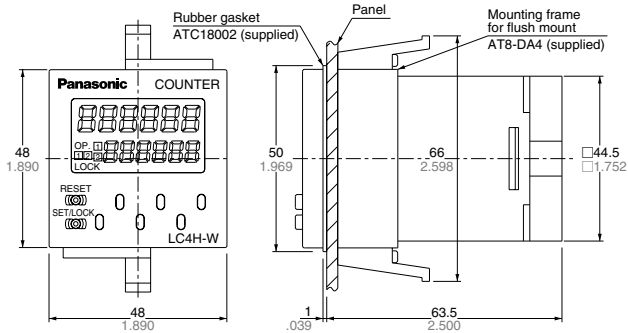

• Dimensions for front panel installations

• Installation panel cut-out dimensions

• For connected installations

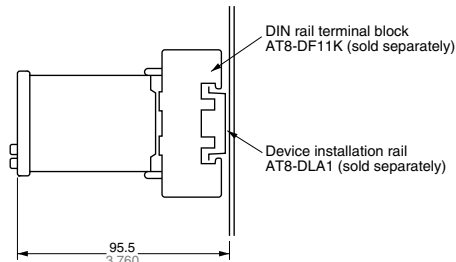

The standard panel cut-out dimensions are shown below. Use the mounting frame (AT8-DA4) and rubber gasket (ATC18002).

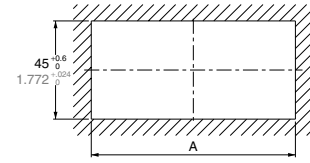
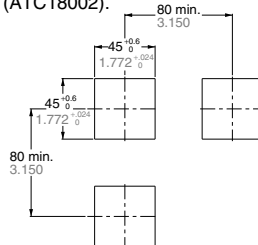

When n units are attached in a continuous series, the dimension of (A) is:

$$A = (48 \times n - 2.5) \text{ } ^{+0.6}$$

Note 1): The installation panel thickness should be between 1 and 5 mm (.039 and .197 inch).

2): For connected installations, the waterproofing ability between the unit and installation panel is lost.

Terminal layouts and Wiring diagrams

• Pin type

Relay output type

Transistor output type

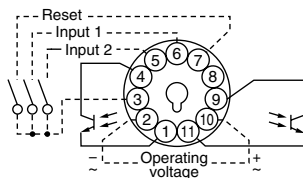
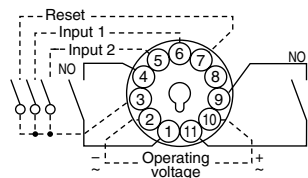

• Screw terminal type

Relay output type

Transistor output type

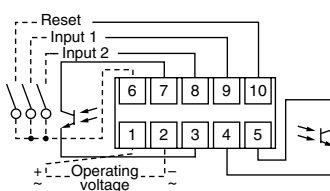
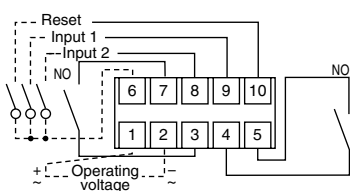

Note) For connecting the output leads of the transistor output type, refer to 5) Transistor output on page 141.

Setting the operation mode and counter

Setting procedure 1) Setting the output mode (output 1, 2)

Set the output 1 and output 2 with the DIP switches on the side of the counter.

The minimum input signal width and maximum counting speed for the reset are set at the same time.

DIP switches

Item	OFF	ON
1	Refer to table 1	
2		
3		
4	20ms	1ms
5	30Hz	5kHz
6	Refer to table 2	
7		
8		

Table 1

DIP switch No.			Output mode (Output 1)
1	2	3	
ON	ON	ON	— (See note 1)
OFF	OFF	OFF	HOLD-B
ON	OFF	OFF	HOLD-C
OFF	ON	OFF	HOLD-D
ON	ON	OFF	SHOT-A
OFF	OFF	ON	— (See note 1)
ON	OFF	ON	— (See note 1)
OFF	ON	ON	— (See note 1)

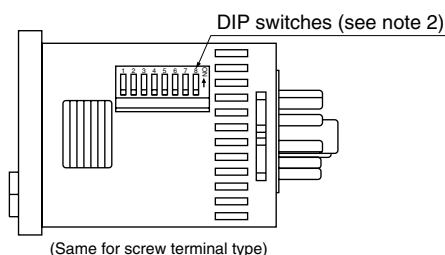

Table 2

DIP switch No.			Output mode (Output 2)
6	7	8	
ON	ON	ON	HOLD-A
OFF	OFF	OFF	HOLD-B
ON	OFF	OFF	HOLD-C
OFF	ON	OFF	HOLD-D
ON	ON	OFF	SHOT-A
OFF	OFF	ON	SHOT-B
ON	OFF	ON	SHOT-C
OFF	ON	ON	SHOT-D

- Notes: 1) The counter and set value displays will display DIP Err.
 2) Set the DIP switches before installing the counter on the panel.
 3) When the DIP SW setting is changed, turn off the power once.
 4) The DIP switches are set as ON before shipping.

Setting procedure 2) Setting the set value

Set the set value with the UP keys on the front of the counter.

Front display section

- Counter display
- Set value display
- Controlled output indicator
- Setting 1/2 selection display (*Note)
- Lock indicator

*Note:
 Pressing the [SET/LOCK] key switches the display between the set value 1 and 2 displays.
 Display either set value [1] or [2], and set the value.

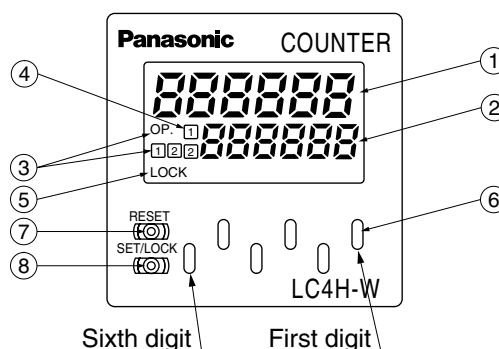

- UP keys
 [Changes the corresponding digit of the set value in the addition direction (upwards)]
- RESET switch
 Resets the counting value and the output
- SET/LOCK switch
 Used to select between the Setting 1 display and Setting 2 display, to set and confirm the input mode, and to lock the keys (UP and RESET keys not responsive to touch).

Procedure 3) Setting the input mode

Set the input mode using the key and switch in the front display section on the counter front.

- Hold down the SET/LOCK key and press the UP key for the first digit. The setting mode is accessed.
- Now release the SET/LOCK key.
- Press the UP key for the first digit and the input position changes counterclockwise.

Example)
 Input mode displayed (UP: addition mode)

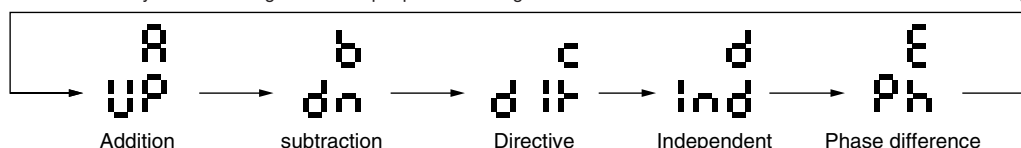
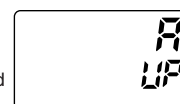

- Press the RESET key and the input mode being displayed is set. The display then goes back to normal.

• Checking the input mode

Hold down the SET/LOCK key and press the UP key for the second digit. The input mode is displayed for about 2 seconds and then the display goes back to normal. (During these 2 seconds, all operations other than the display are being performed.)

• Locking the keys

Hold down the SET/LOCK key and press the UP key for the sixth digit. The keys will lock. This means that the UP and RESET keys do not respond to touch. To unlock the keys, hold down the SET/LOCK key and press the UP key for the sixth digit again.

* The input mode, maximum counting speed and minimum reset signal width cannot be preset independently for Setting 1 and Setting 2.

• Selecting the Setting 1 or Setting 2 display

Press the SET/LOCK key and the display changes between Setting 1 and Setting 2. (This operation does not affect overall operation.)

• Changing the setting

1. While the counter is working, the UP key can be used to change the setting. Keep the following points in mind, however.

- Suppose that a preset count-up value is smaller than the displayed count value. The counter counts up to the full scale mark (999999), goes back to "0", and counts up again to the preset number. When the preset count-up value is larger than the displayed count value, the counter counts up to the preset value.
- Suppose that the counter is preset to count down. Whether a preset count-down value is smaller or larger than the count value, the counter counts down to "0".

2. When the preset value is "0", the counter does not start in the count-up mode. It starts counting up when the count value comes to "0" again.

- Up-count input
 The counter counts up to the full scale mark (999999), goes back to "0" and starts counting up again.
- Down-count input
 The counter counts down to the full scale mark (-99999) and the display reads = = = = = . The count value does not become "0" and so the counter does not count up.
- Direction input, individual input, and phase input
 The preset value is counted up or down to any number other than "0" once. When it comes to "0" again, the counter starts counting up.

Operation modes

1. Input mode

① For the input mode, you can choose one of the following five modes.

- Addition UP
- Subtraction DOWN
- Directive DIR
- Independent IND
- Phase PHASE

② After the counter has been reset, setting 2 is displayed in the count-down mode. "0" appears instead in all other modes.

Input mode	Operation	*Minimum input signal width 30 Hz: 16.7 ms; 5 kHz: 0.1 ms
Addition UP	IN1 or IN2 works as an input block (gate) for the other input.	<p>• Example where IN1 is the counting input and IN2 is the input block (gate).</p> <p>Counting (addition) 0 1 2 3 ---- n-3 n-2 n-1 n</p> <p>Counting (subtraction) n n-1 n-2 n-3 ---- 3 2 1 0</p> <p style="text-align: center;">△ Reset △ Count UP</p>
Subtraction DOWN		<p>• Example where IN2 is the counting input and IN1 is the input block (gate).</p> <p>Counting (addition) 0 1 2 3 4 ---- n-1 n</p> <p>Counting (subtraction) n n-1 n-2 n-3 n-4 ---- 1 0</p> <p style="text-align: center;">△ Reset △ Count UP</p>
Directive DIR	IN1 is the counting input and IN2 is the addition or subtraction directive input. IN2 adds at L level and subtracts at H level.	<p>Counting 0 1 2 3 4 3 2 1 0 1 2 3 4</p> <p style="text-align: center;">△ Reset</p>
Independent IND	IN1 is addition input and IN2 is subtraction input.	<p>Counting 0 1 2 3 4 3 2 1 2 1 2 3</p> <p style="text-align: center;">△ Reset</p>
Phase PHASE	Addition when the IN1 phase advances beyond IN2, and subtraction when the IN2 phase advances beyond IN1.	<p>Counting 0 1 2 3 2 1 0</p> <p style="text-align: center;">△ Reset</p>

* "A" must be more than the minimum input signal width. *n: Set value 2

* "A" must be more than the minimum input signal width. *n: Set value 2

* IN1 and IN2 are completely independent, so there is no restriction on signal timing.

* "B" must be more than the minimum input signal width.

2. Output mode

For the set value 1, you can choose one of the following four modes.

- Maintain output/over count I HOLD-B
- Maintain output/over count II HOLD-C
- Maintain output/over count III HOLD-D
- One shot/over count SHOT-A

For the set value 2, you can choose one of the following eight modes.

- Maintain output/hold count HOLD-A
- Maintain output/over count I HOLD-B
- Maintain output/over count II HOLD-C
- Maintain output/over count III HOLD-D
- One shot/over count SHOT-A
- One shot/recount I SHOT-B
- One shot/recount II SHOT-C
- One shot/hold count SHOT-D

• Output mode for set value 1

Output mode	Operation	(Example when input mode is either addition or subtraction)
Maintain output Over count I HOLD-B	Output control is maintained after count-up completion and until resetting. However, counting is possible despite completion of count-up.	<p>* n: Set value 1</p>
Maintain output Over count II HOLD-C	Output control is maintained after count-up completion and until the next signal enters. However, counting is possible despite completion of count-up.	<p>* n: Set value 1</p>
Maintain output Over count III HOLD-D	If the count value is greater than or equal to the preset value when counting up, the control output is held. The count operation is possible anyway.	<p>* n: Set value 1</p>
One shot Over count SHOT-A	Output control is maintained after count-up completion for a fixed time (approx. 1 sec). Counting is possible despite completion of count-up.	<p>* n: Set value 1</p>

LC4H-W

• Output mode for set value 2

Output mode	Operation	(Example when input mode is either addition or subtraction)																		
Maintain output Hold count HOLD-A	Output control is maintained after count-up completion and until resetting. During that time, the count display does not change from that at count-up completion.	<p>Counting (addition) <table border="1"><tr><td>-----</td><td>n-3</td><td>n-2</td><td>n-1</td><td>n</td></tr></table></p> <p>Counting (subtraction) <table border="1"><tr><td>-----</td><td>3</td><td>2</td><td>1</td><td>0</td></tr></table></p> <p>Counting able/unable </p> <p>Output control 2 <table border="1"><tr><td>OFF</td><td>ON</td></tr></table></p> <p>* n: Set value 2</p>	-----	n-3	n-2	n-1	n	-----	3	2	1	0	OFF	ON						
-----	n-3	n-2	n-1	n																
-----	3	2	1	0																
OFF	ON																			
Maintain output Over count I HOLD-B	Output control is maintained after count-up completion and until resetting. However, counting is possible despite completion of count-up.	<p>Counting (addition) <table border="1"><tr><td>-----</td><td>n-2</td><td>n-1</td><td>n</td><td>n+1</td><td>n+2</td><td>-----</td></tr></table></p> <p>Counting (subtraction) <table border="1"><tr><td>-----</td><td>2</td><td>1</td><td>0</td><td>-1</td><td>-2</td><td>-----</td></tr></table></p> <p>Counting able/unable </p> <p>Output control 2 <table border="1"><tr><td>OFF</td><td>ON</td></tr></table></p> <p>* n: Set value 2</p>	-----	n-2	n-1	n	n+1	n+2	-----	-----	2	1	0	-1	-2	-----	OFF	ON		
-----	n-2	n-1	n	n+1	n+2	-----														
-----	2	1	0	-1	-2	-----														
OFF	ON																			
Maintain output Over count II HOLD-C	Output control is maintained after count-up completion and until the next signal enters. However, counting is possible despite completion of count-up.	<p>Counting (addition) <table border="1"><tr><td>-----</td><td>n-2</td><td>n-1</td><td>n</td><td>n+1</td><td>n+2</td><td>-----</td></tr></table></p> <p>Counting (subtraction) <table border="1"><tr><td>-----</td><td>2</td><td>1</td><td>0</td><td>-1</td><td>-2</td><td>-----</td></tr></table></p> <p>Counting able/unable </p> <p>Output control 2 <table border="1"><tr><td>OFF</td><td>ON</td><td>OFF</td></tr></table></p> <p>* n: Set value 2</p>	-----	n-2	n-1	n	n+1	n+2	-----	-----	2	1	0	-1	-2	-----	OFF	ON	OFF	
-----	n-2	n-1	n	n+1	n+2	-----														
-----	2	1	0	-1	-2	-----														
OFF	ON	OFF																		
Maintain output Over count III HOLD-D	If the count value is greater than or equal to the preset value when counting up, the counter starts counting up again. The count operation is possible anyway.	<p>Counting (addition) <table border="1"><tr><td>-----</td><td>n-2</td><td>n-1</td><td>n</td><td>n+1</td><td>n+2</td><td>-----</td></tr></table></p> <p>Counting (subtraction) <table border="1"><tr><td>-----</td><td>2</td><td>1</td><td>0</td><td>-1</td><td>-2</td><td>-----</td></tr></table></p> <p>Counting able/unable </p> <p>Output control 2 (addition) <table border="1"><tr><td>OFF</td><td>ON</td></tr></table></p> <p>Output control 2 (subtraction) <table border="1"><tr><td>OFF</td><td>ON</td></tr></table></p> <p>* n: Set value 2</p>	-----	n-2	n-1	n	n+1	n+2	-----	-----	2	1	0	-1	-2	-----	OFF	ON	OFF	ON
-----	n-2	n-1	n	n+1	n+2	-----														
-----	2	1	0	-1	-2	-----														
OFF	ON																			
OFF	ON																			
One shot Over count SHOT-A	Output control is maintained after count-up completion for a fixed time (approx. 1 sec). Counting is possible despite completion of count-up.	<p>Counting (addition) <table border="1"><tr><td>-----</td><td>n-2</td><td>n-1</td><td>n</td><td>n+1</td><td>n+2</td><td>-----</td></tr></table></p> <p>Counting (subtraction) <table border="1"><tr><td>-----</td><td>2</td><td>1</td><td>0</td><td>-1</td><td>-2</td><td>-----</td></tr></table></p> <p>Counting able/unable </p> <p>Output control 2 <table border="1"><tr><td>OFF</td><td>ON (Approx. 1s)</td><td>OFF</td></tr></table></p> <p>* n: Set value 2</p>	-----	n-2	n-1	n	n+1	n+2	-----	-----	2	1	0	-1	-2	-----	OFF	ON (Approx. 1s)	OFF	
-----	n-2	n-1	n	n+1	n+2	-----														
-----	2	1	0	-1	-2	-----														
OFF	ON (Approx. 1s)	OFF																		
One shot Recount I SHOT-B	Output control is maintained after count-up completion for a fixed time (approx. 1 sec). Counting is possible despite completion of count-up. However, reset occurs simultaneous with completion of count-up. While output is being maintained, restarting of the count is not possible.	<p>Counting (addition) <table border="1"><tr><td>-----</td><td>n-2</td><td>n-1</td><td>0</td><td>1</td><td>2</td><td>-----</td></tr></table></p> <p>Counting (subtraction) <table border="1"><tr><td>-----</td><td>2</td><td>1</td><td>n</td><td>n-1</td><td>n-2</td><td>-----</td></tr></table></p> <p>Counting able/unable </p> <p>Output control 2 <table border="1"><tr><td>OFF</td><td>ON (Approx. 1s)</td><td>OFF</td></tr></table></p> <p>* n: Set value 2</p>	-----	n-2	n-1	0	1	2	-----	-----	2	1	n	n-1	n-2	-----	OFF	ON (Approx. 1s)	OFF	
-----	n-2	n-1	0	1	2	-----														
-----	2	1	n	n-1	n-2	-----														
OFF	ON (Approx. 1s)	OFF																		