



Chipsmall Limited consists of a professional team with an average of over 10 year of expertise in the distribution of electronic components. Based in Hongkong, we have already established firm and mutual-benefit business relationships with customers from,Europe,America and south Asia,supplying obsolete and hard-to-find components to meet their specific needs.

With the principle of “Quality Parts,Customers Priority,Honest Operation,and Considerate Service”,our business mainly focus on the distribution of electronic components. Line cards we deal with include Microchip,ALPS,ROHM,Xilinx,Pulse,ON,Everlight and Freescale. Main products comprise IC,Modules,Potentiometer,IC Socket,Relay,Connector.Our parts cover such applications as commercial,industrial, and automotives areas.

We are looking forward to setting up business relationship with you and hope to provide you with the best service and solution. Let us make a better world for our industry!



Contact us

Tel: +86-755-8981 8866 Fax: +86-755-8427 6832

Email & Skype: info@chipsmall.com Web: www.chipsmall.com

Address: A1208, Overseas Decoration Building, #122 Zhenhua RD., Futian, Shenzhen, China



LC75879PT

1/4, 1/3-Duty General-Purpose LCD Driver



ON Semiconductor®

www.onsemi.com

Overview

The LC75879PT is the 1/4 duty and 1/3 duty general-purpose microprocessor-controlled LCD driver that can be used in applications such as frequency display in products with electronic tuning. In addition to being able to drive up to 272 segments directly, the LC75879PT can also control up to 8 general-purpose output ports. Because it has the PWM output of a maximum of 3 ch, the brightness control of the LED backlight of RGB can be done. Incorporation of an oscillation circuit helps to reduce the number of external resistors and capacitors required.

Features

- Support for 1/4-duty 1/3-bias or 1/3-duty 1/3-bias drive techniques under serial data control.
 - When 1/4-duty: Capable of driving up to 272 segments
 - When 1/3-duty: Capable of driving up to 207 segments
- Serial data input supports CCB* format communication with the system controller (Support 3.3 V and 5 V operation).
- Serial data control of the power-saving mode based backup function and the all segments forced off function.
- Serial data control of switching between the segment output port and general-purpose output port function.
(Support for up to 8 general-purpose output ports)
- Support for the PWM output function of a maximum of 3 ch (It can output from the general-purpose output port).
- Support for clock output function of 1 ch (It can output from the general-purpose output port).
- Serial data control of the frame frequency of the common and segment output waveforms.
- Serial data control of switching between the internal oscillator operating mode and external clock operating mode.
- High generality, since display data is displayed directly without the intervention of a decoder circuit.
- Built-in display contrast adjustment circuit.
- The INH pin allows the display to be forced to the off state.
- Incorporation of an oscillator circuit (Incorporation of resistor and capacitor for an oscillation).

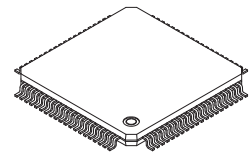

TQFP80 12x12 / TQFP80J

* Computer Control Bus (CCB) is an ON Semiconductor's original bus format and the bus addresses are controlled by ON Semiconductor.

ORDERING INFORMATION

See detailed ordering and shipping information on page 35 of this data sheet.

LC75879PT

Specifications

Absolute Maximum Ratings at Ta = 25°C, VSS = 0 V

Parameter	Symbol	Conditions	Ratings	Unit
Maximum supply voltage	VDD max	VDD	-0.3 to +6.8	V
Input voltage	VIN1	CE, CL, DI, $\overline{\text{INH}}$	-0.3 to +6.8	V
	VIN2	OSCI, VDD1, VDD2	-0.3 to VDD+0.3	
Output voltage	VOU	S1 to S69, COM1 to COM4, P1 to P8	-0.3 to VDD+0.3	V
Output current	IOUT1	S1 to S68	300	μA
	IOUT2	COM1 to COM4, S69	3	mA
	IOUT3	P1 to P8	5	
Allowable power dissipation	Pd max	Ta = 85°C	200	mW
Operating temperature	Topr		-40 to +85	°C
Storage temperature	Tstg		-55 to +125	°C

Stresses exceeding those listed in the Maximum Ratings table may damage the device. If any of these limits are exceeded, device functionality should not be assumed, damage may occur and reliability may be affected.

Allowable Operating Ranges at Ta = -40 to +85°C, VSS = 0 V

Parameter	Symbol	Conditions	Ratings			Unit
			min	typ	max	
Supply voltage	VDD	VDD	4.5		6.3	V
Input voltage *1	VDD1	VDD1		2/3VDD0	VDD0	V
	VDD2	VDD2		1/3VDD0	VDD0	
Input high level voltage	VIH1	CE, CL, DI, $\overline{\text{INH}}$	0.4VDD		6.3	V
	VIH2	OSCI: External clock operating mode	0.4VDD		VDD	
Input low level voltage	VIL1	CE, CL, DI, $\overline{\text{INH}}$	0		0.2VDD	V
	VIL2	OSCI: External clock operating mode	0		0.2VDD	
External clock operating frequency	fCK	OSCI: External clock operating mode [Figure4]	10	300	600	kHz
External clock duty cycle	DCK	OSCI: External clock operating mode [Figure4]	30	50	70	%
Data setup time	tds	CL, DI [Figure2], [Figure3]	160			ns
Data hold time	tdh	CL, DI [Figure2], [Figure3]	160			ns
CE wait time	tcp	CE, CL [Figure2], [Figure3]	160			ns
CE setup time	tcs	CE, CL [Figure2], [Figure3]	160			ns
CE hold time	tch	CE, CL [Figure2], [Figure3]	160			ns
High level clock pulse width	tφH	CL [Figure2], [Figure3]	160			ns
Low level clock pulse width	tφL	CL [Figure2], [Figure3]	160			ns
Rise time	tr	CE, CL, DI [Figure2], [Figure3]		160		ns
Fall time	tf	CE, CL, DI [Figure2], [Figure3]		160		ns
$\overline{\text{INH}}$ switching time	tc	$\overline{\text{INH}}$, CE [Figure5], [Figure6] [Figure7], [Figure8]	10			μs

Note : *1. VDD0 = 0.70VDD to VDD

Functional operation above the stresses listed in the Recommended Operating Ranges is not implied. Extended exposure to stresses beyond the Recommended Operating Ranges limits may affect device reliability.

LC75879PT

Electrical Characteristics for the Allowable Operating Ranges

Parameter	Symbol	Pin	Conditions	Ratings			Unit
				min	typ	max	
Hysteresis	V_H	CE, CL, DI, \overline{INH}			0.03 V_{DD}		V
Input high level current	I_{IH1}	CE, CL, DI, \overline{INH}	$V_I = 6.3$ V			5.0	μ A
	I_{IH2}	OSCI	$V_I = V_{DD}$: External clock operating mode			5.0	
Input low level current	I_{IL1}	CE, CL, DI, \overline{INH}	$V_I = 0$ V	-5.0			μ A
	I_{IL2}	OSCI	$V_I = 0$ V: External clock operating mode	-5.0			
Output high level voltage *1	V_{OH1}	S1 to S69	$I_O = -20$ μ A	$V_{DD0} - 0.9$			V
	V_{OH2}	COM1 to COM4	$I_O = -100$ μ A	$V_{DD0} - 0.9$			
	V_{OH3}	P1 to P8	$I_O = -1$ mA	$V_{DD} - 0.9$			
Output low level voltage	V_{OL1}	S1 to S69	$I_O = 20$ μ A			0.9	V
	V_{OL2}	COM1 to COM4	$I_O = 100$ μ A			0.9	
	V_{OL3}	P1 to P8	$I_O = 1$ mA			0.9	
Output middle level voltage *1 *2	V_{MID1}	S1 to S69	1/3 bias $I_O = \pm 20$ μ A	$2/3V_{DD0} - 0.9$		$2/3V_{DD0} + 0.9$	V
	V_{MID2}	S1 to S69	1/3 bias $I_O = \pm 20$ μ A	$1/3V_{DD0} - 0.9$		$1/3V_{DD0} + 0.9$	
	V_{MID3}	COM1 to COM4	1/3 bias $I_O = \pm 100$ μ A	$2/3V_{DD0} - 0.9$		$2/3V_{DD0} + 0.9$	
	V_{MID4}	COM1 to COM4	1/3 bias $I_O = \pm 100$ μ A	$1/3V_{DD0} - 0.9$		$1/3V_{DD0} + 0.9$	
Oscillator frequency	fosc	Internal oscillator circuit	Internal oscillator operating mode	240	300	360	kHz
Current drain	I_{DD1}	V_{DD}	Power-saving mode			100	μ A
	I_{DD2}	V_{DD}	$V_{DD} = 6.3$ V Output open Internal oscillator operating mode		1000	2000	
	I_{DD3}	V_{DD}	$V_{DD} = 6.3$ V Output open External clock operating mode $f_{CK} = 300$ kHz $V_{IH2} = 0.5V_{DD}$ $V_{IL2} = 0.1V_{DD}$		1000	2000	

Note: *1. $V_{DD0} = 0.70V_{DD}$ to V_{DD}

Note: *2. Excluding the bias voltage generation divider resistors built in the V_{DD1} and V_{DD2} . (See Figure 1.)

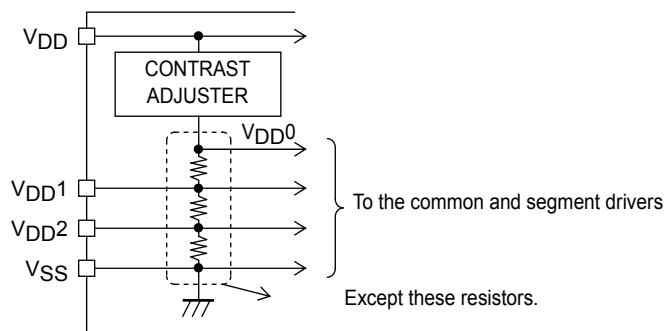

[Figure 1]

Product parametric performance is indicated in the Electrical Characteristics for the listed test conditions, unless otherwise noted. Product performance may not be indicated by the Electrical Characteristics if operated under different conditions.

LC75879PT

1. When CL is stopped at the low level

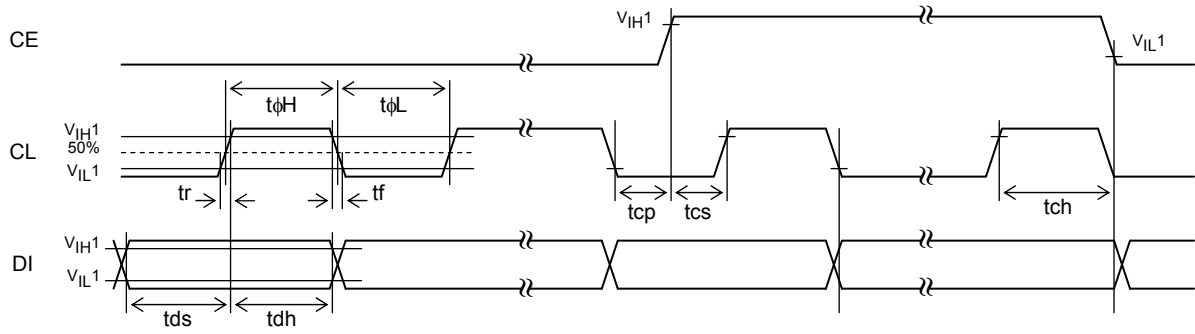

[Figure 2]

2. When CL is stopped at the high level

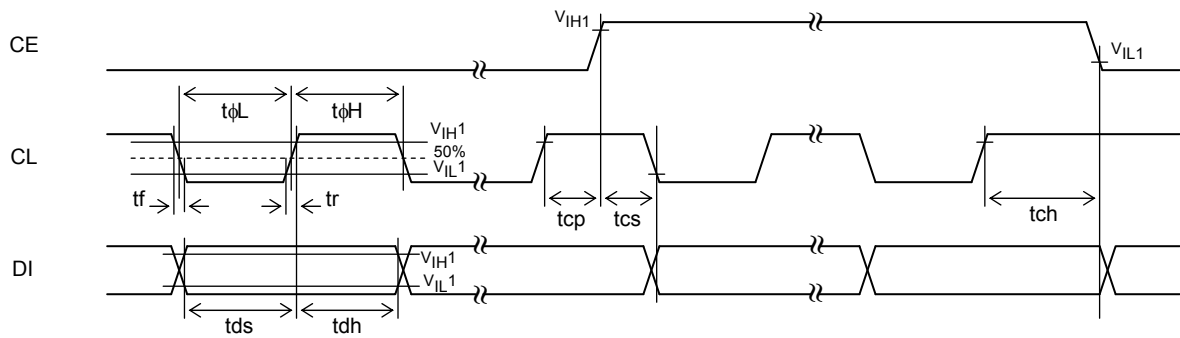

[Figure 3]

3. OSCI pin clock timing in external clock operating mode

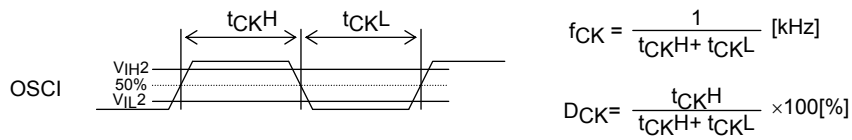

$$f_{CK} = \frac{1}{t_{CKH} + t_{CKL}} \text{ [kHz]}$$

$$D_{CK} = \frac{t_{CKH}}{t_{CKH} + t_{CKL}} \times 100\%$$

[Figure 4]

LC75879PT

Package Dimensions

unit : mm

TQFP80 12x12 / TQFP80J

CASE 932AX

ISSUE A

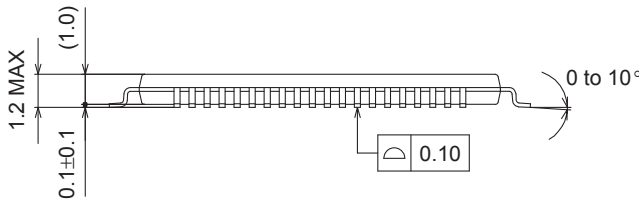
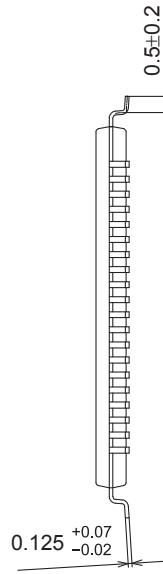
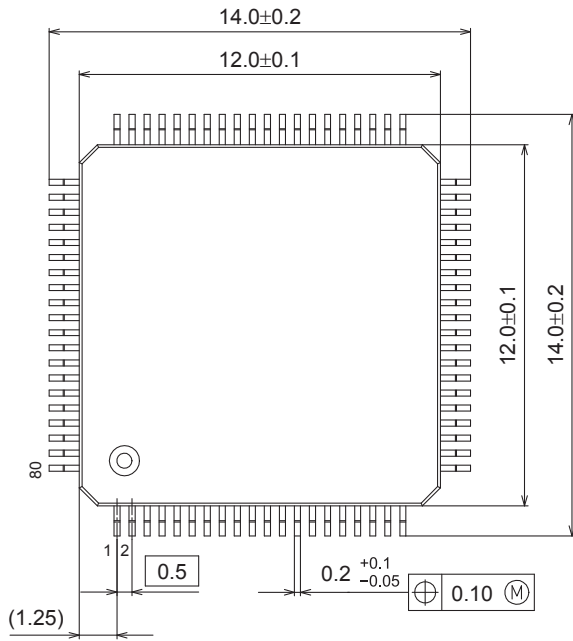

SOLDERING FOOTPRINT*

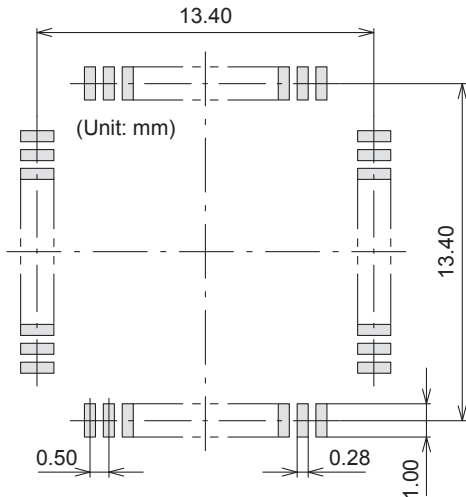

GENERIC MARKING DIAGRAM*

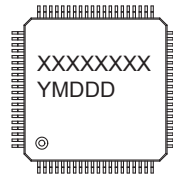

XXXXX = Specific Device Code
 Y = Year
 M = Month
 DDD = Additional Traceability Data

*This information is generic. Please refer to device data sheet for actual part marking. Pb-Free indicator, "G" or microdot "■", may or may not be present.

NOTE: The measurements are not to guarantee but for reference only.

*For additional information on our Pb-Free strategy and soldering details, please download the ON Semiconductor Soldering and Mounting Techniques Reference Manual, SOLDERRM/D.

LC75879PT

Pin Assignment

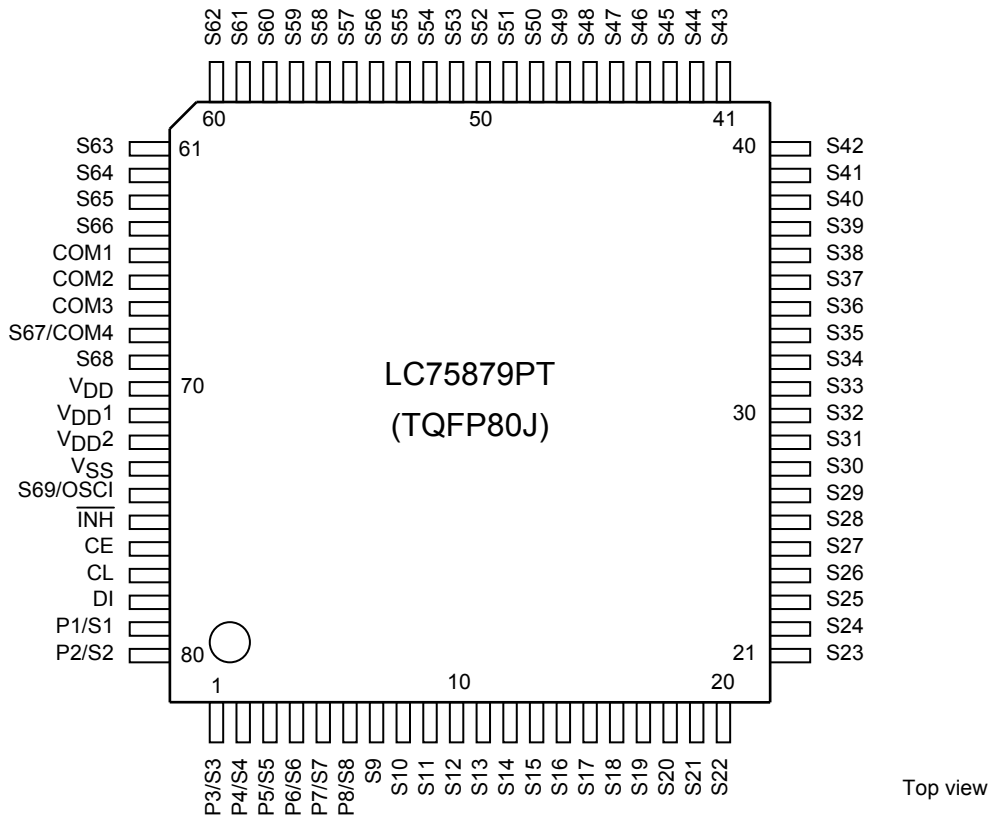

Block Diagram

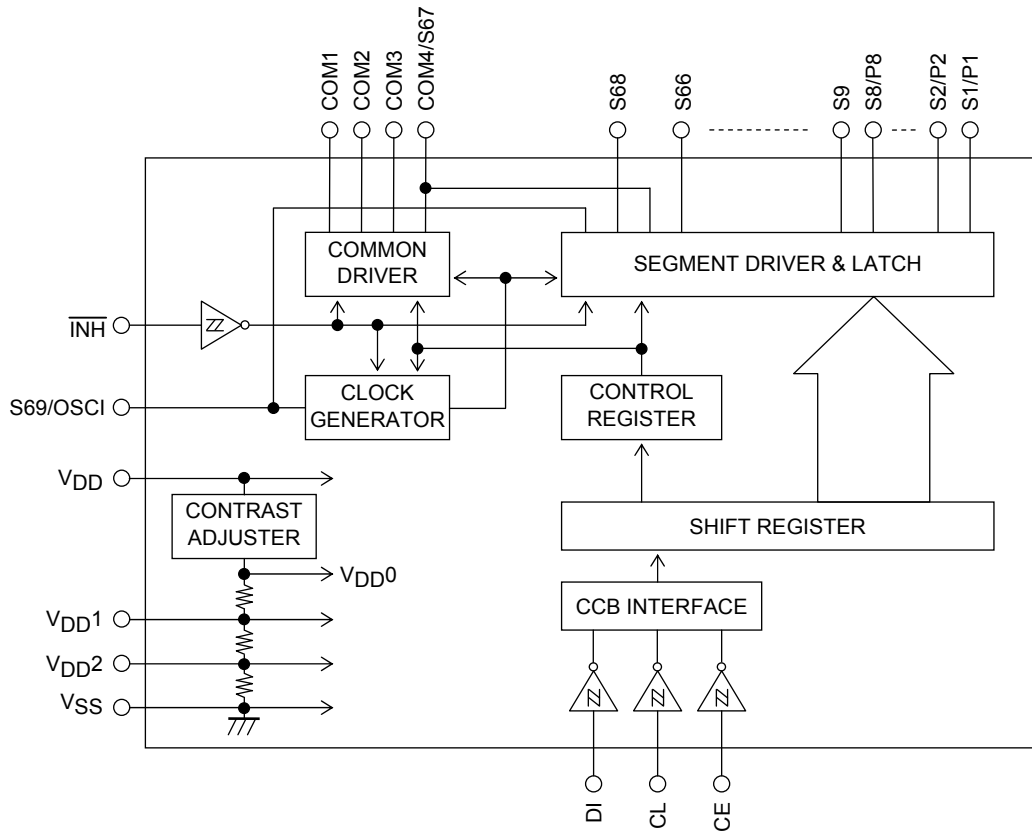

LC75879PT

Pin Functions

Pin	Pin No.	Function	Active	I/O	Handling when unused
S1/P1 to S8/P8 S9 to S66 S68	79, 80, 1 to 6 7 to 64 69	Segment outputs for displaying the display data transferred by serial data input. The S1/P1 to S8/P8 pins can be used as general-purpose output ports under serial data control.	-	O	OPEN
COM1 to COM3 COM4/S67	65 to 67 68	Common driver outputs The frame frequency is f_0 [Hz]. The COM4/S67 pin can be used as a segment output in 1/3 duty.	-	O	OPEN
S69/OSCI	74	Segment output. This pin can also be used as the external clock input pin when the external clock operating mode is selected by control data.	-	I/O	OPEN
CE	76	Serial data transfer inputs. Must be connected to the controller. CE: Chip enable CL: Synchronization clock DI: Transfer data	H	I	GND
CL	77			I	
DI	78		-	I	
$\overline{\text{INH}}$	75	<p>Display off control input</p> <p>•$\overline{\text{INH}}=\text{low}(V_{\text{SS}})$...Display forced off S1/P1 to S8/P8=$\text{low}(V_{\text{SS}})$ (These pins are forcibly set to the general-purpose output port function and held at the V_{SS} level.) S9 to S66,S68=$\text{low}(V_{\text{SS}})$ COM1 to COM3=$\text{low}(V_{\text{SS}})$ COM4/S67=$\text{low}(V_{\text{SS}})$ S69/OSCI=$\text{low}(V_{\text{SS}})$ (This pin is forcibly set to the segment output port function and held at the V_{SS} level.) Stops the internal oscillator. Inhibits external clock input. Display contrast adjustment circuit stopped.</p> <p>•$\overline{\text{INH}}=\text{high}(V_{\text{DD}})$...Display on Enables the internal oscillator circuit. (Internal oscillator operating mode) Enables external clock input. (External clock operating mode) Display contrast adjustment circuit operation is enabled.</p> <p>However, serial data transfer is possible when the display is forced off.</p>	L	I	GND
V_{DD1}	71	Used to apply the LCD drive 2/3 bias voltage externally.	-	I	OPEN
V_{DD2}	72	Used to apply the LCD drive 1/3 bias voltage externally.	-	I	OPEN
V_{DD}	70	Power supply pin. A power voltage of 4.5 to 6.3 V must be applied to this pin.	-	-	-
V_{SS}	73	Ground pin. Must be connected to ground.	-	-	-

LC75879PT

Serial Data Input

1. 1/4 duty

(1) When CL is stopped at the low level

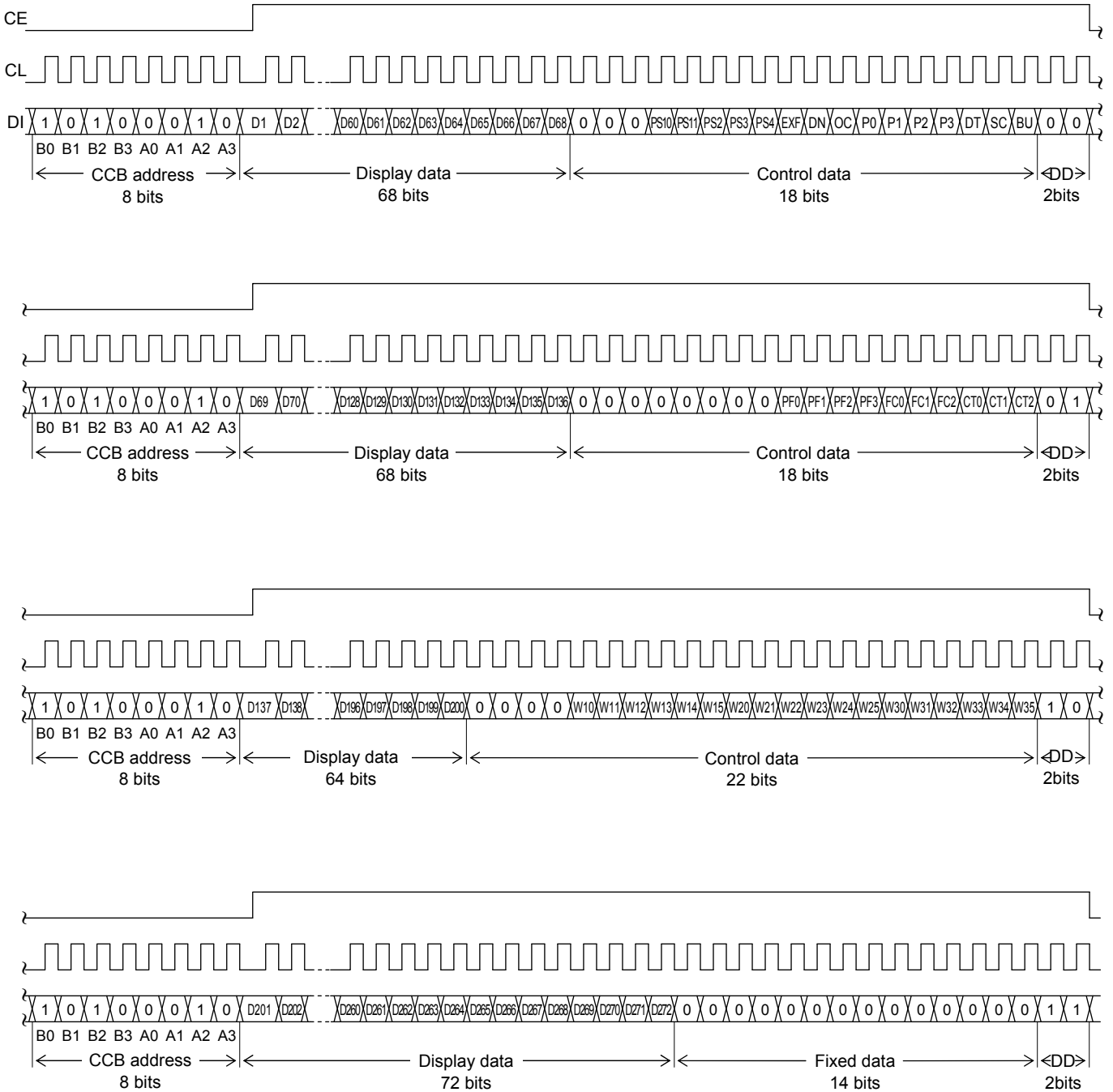

Note: DD is the direction data.

LC75879PT

(2) When CL is stopped at the high level

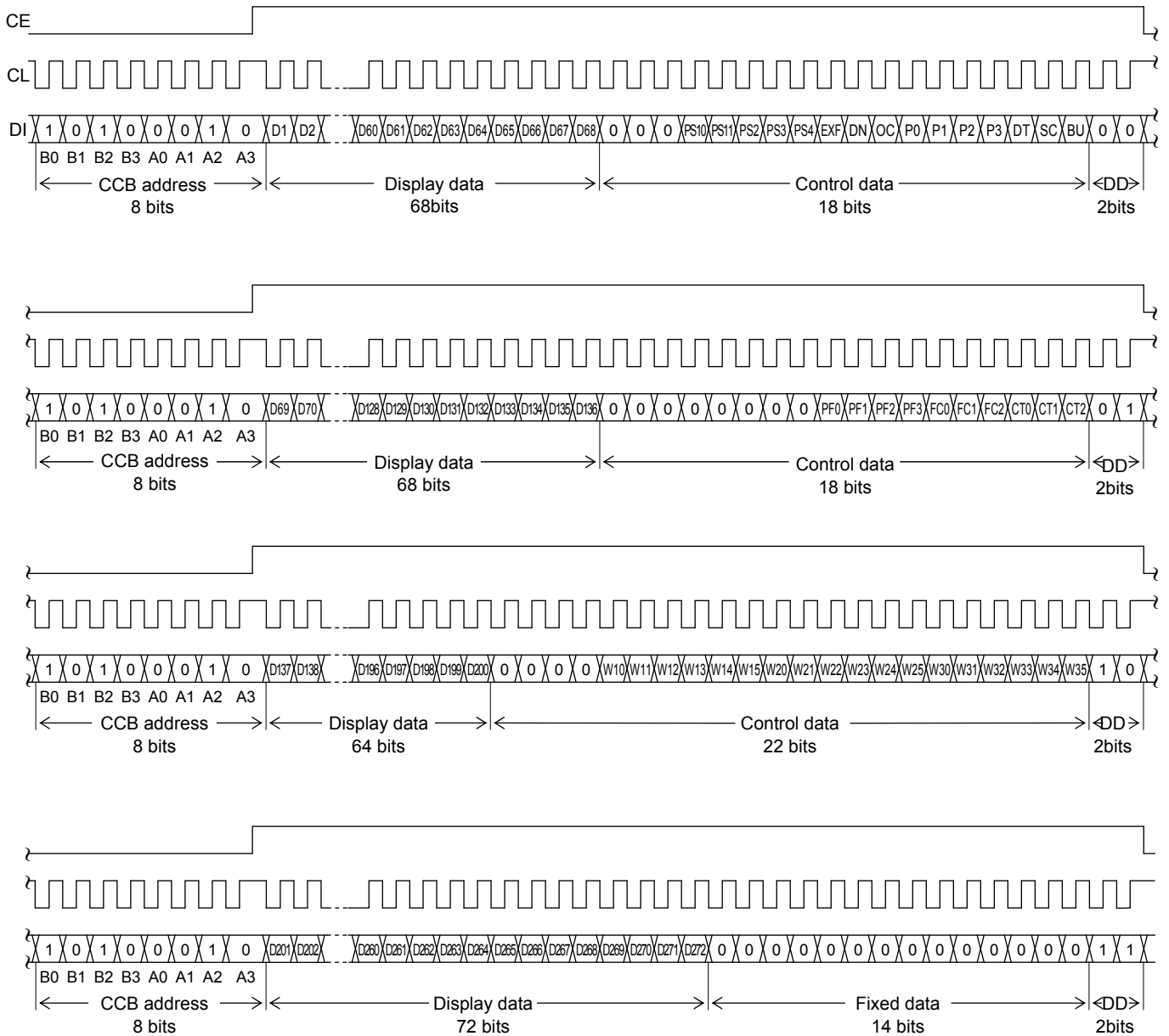

Note: DD is the direction data

- CCB address “45H”
- D1 to D272 Display data
- PS10, PS11, PS2 to PS4 General-purpose output port (P1 to P4) function setting control data
- EXF External clock operating frequency setting control data
- DN S68 pin and S69/OSCI pin state setting control data
- OC Internal oscillator operating mode/external clock operating mode switching control data
- P0 to P3 Segment output port/general-purpose output port switching control data
- DT 1/4-duty 1/3-bias drive or 1/3-duty 1/3-bias drive switching control data
- SC Segment on/off control data
- BU Normal mode/power-saving mode control data
- PF0 to PF3 PWM output waveform frame frequency setting control data
- FC0 to FC2 Common/segment output waveform frame frequency setting control data
- CT0 to CT2 Display contrast setting control data
- W10 to W15, W20 to W25, ... PWM data of the PWM output
W30 to W35

LC75879PT

2. 1/3 duty

(1) When CL is stopped at the low level

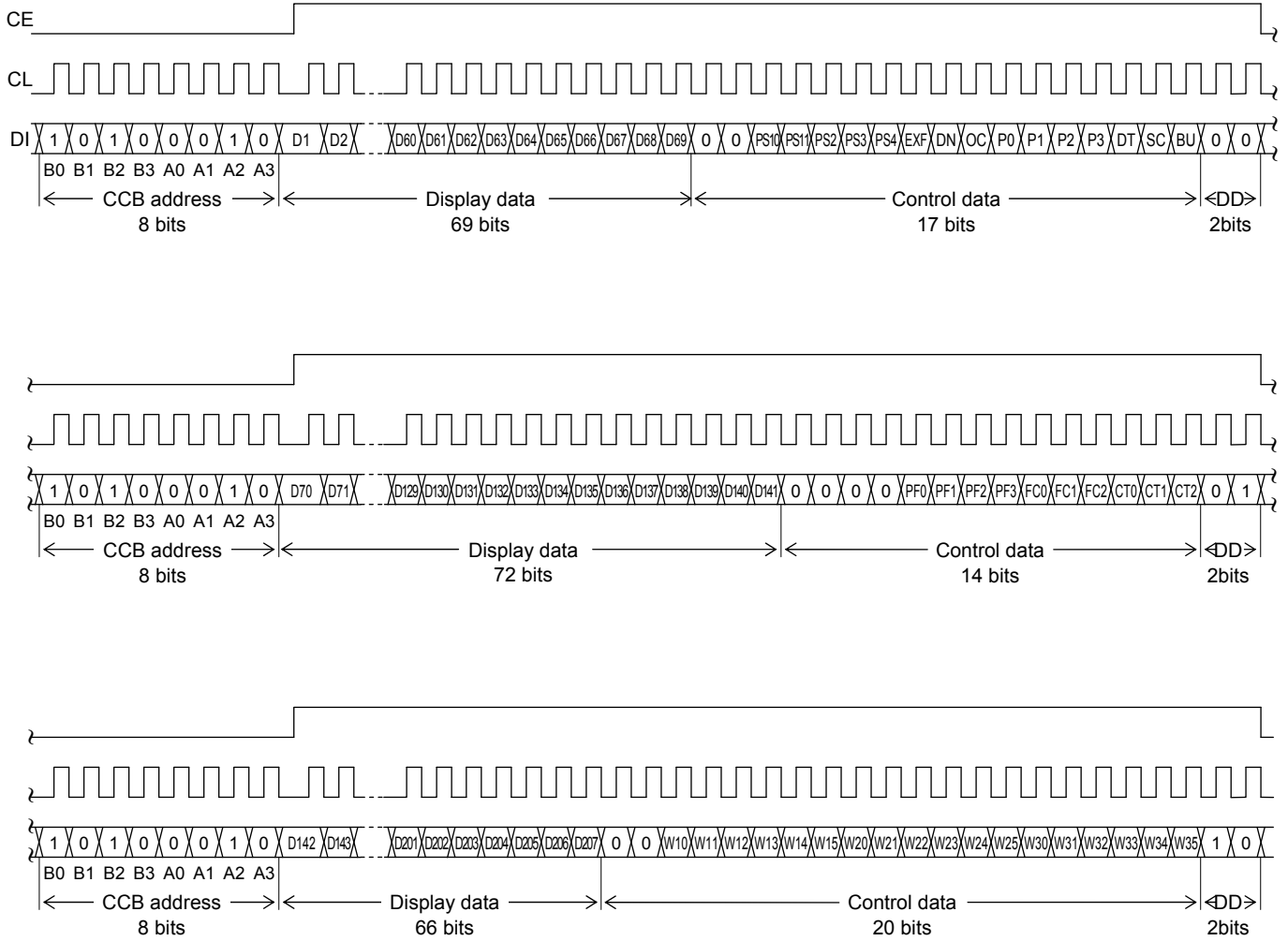

Note: DD is the direction data.

LC75879PT

(2) When CL is stopped at the low level

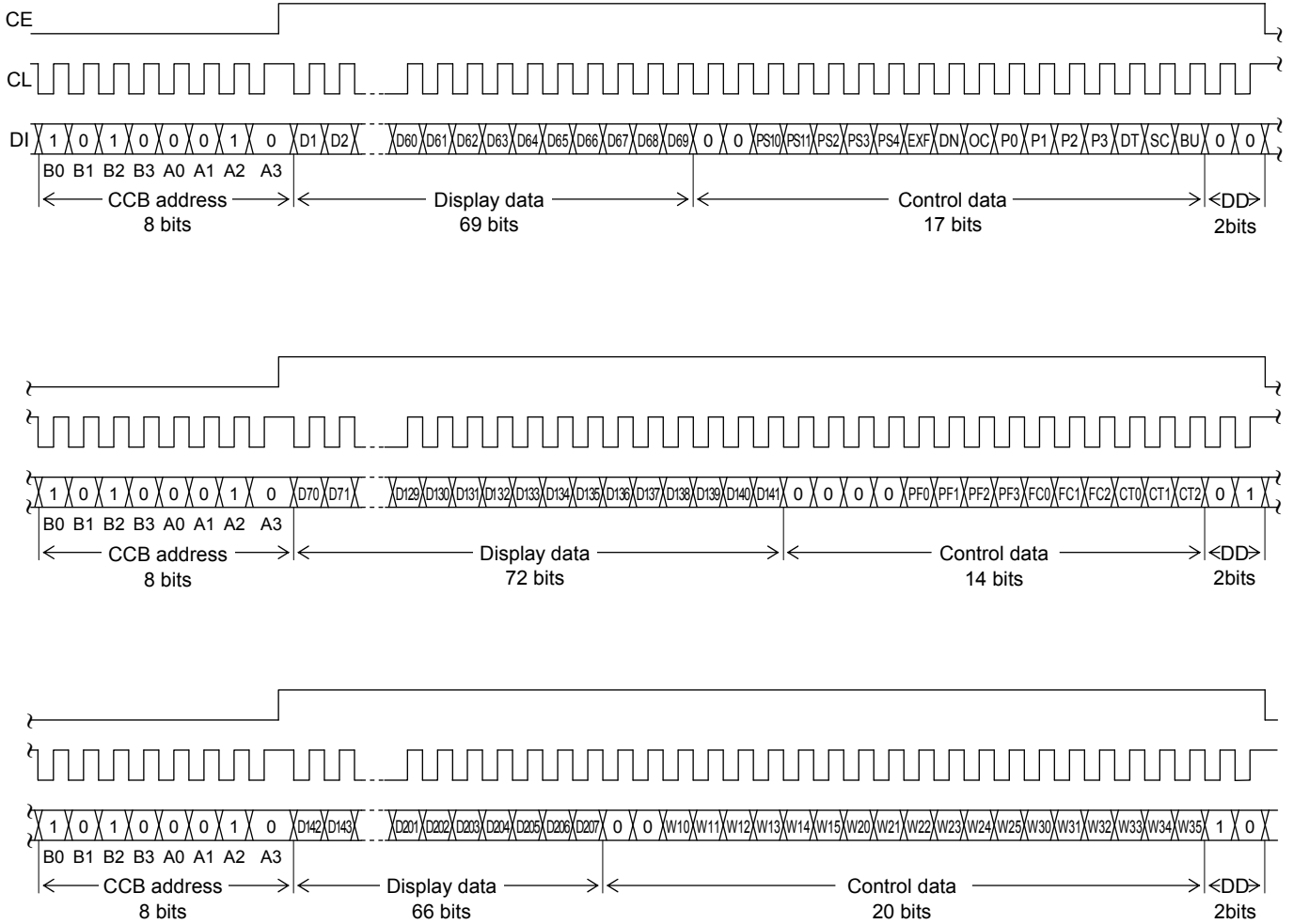

Note: DD is the direction data.

- CCB address “45H”
- D1 to D207 Display data
- PS10, PS11, PS2 to PS4 General-purpose output port (P1 to P4) function setting control data
- EXF External clock operating frequency setting control data
- DN S68 pin and S69/OSCI pin state setting control data
- OC Internal oscillator operating mode/external clock operating mode switching control data
- P0 to P3 Segment output port/general-purpose output port switching control data
- DT 1/4-duty 1/3-bias drive or 1/3-duty 1/3-bias drive switching control data
- SC Segment on/off control data
- BU Normal mode/power-saving mode control data
- PF0 to PF3 PWM output waveform frame frequency setting control data
- FC0 to FC2 Common/segment output waveform frame frequency setting control data
- CT0 to CT2 Display contrast setting control data
- W10 to W15, W20 to W25, ... PWM data of the PWM output
W30 to W35

LC75879PT

3. 1/4 duty (Simple mode transfer) (1) When CL is stopped at the low level

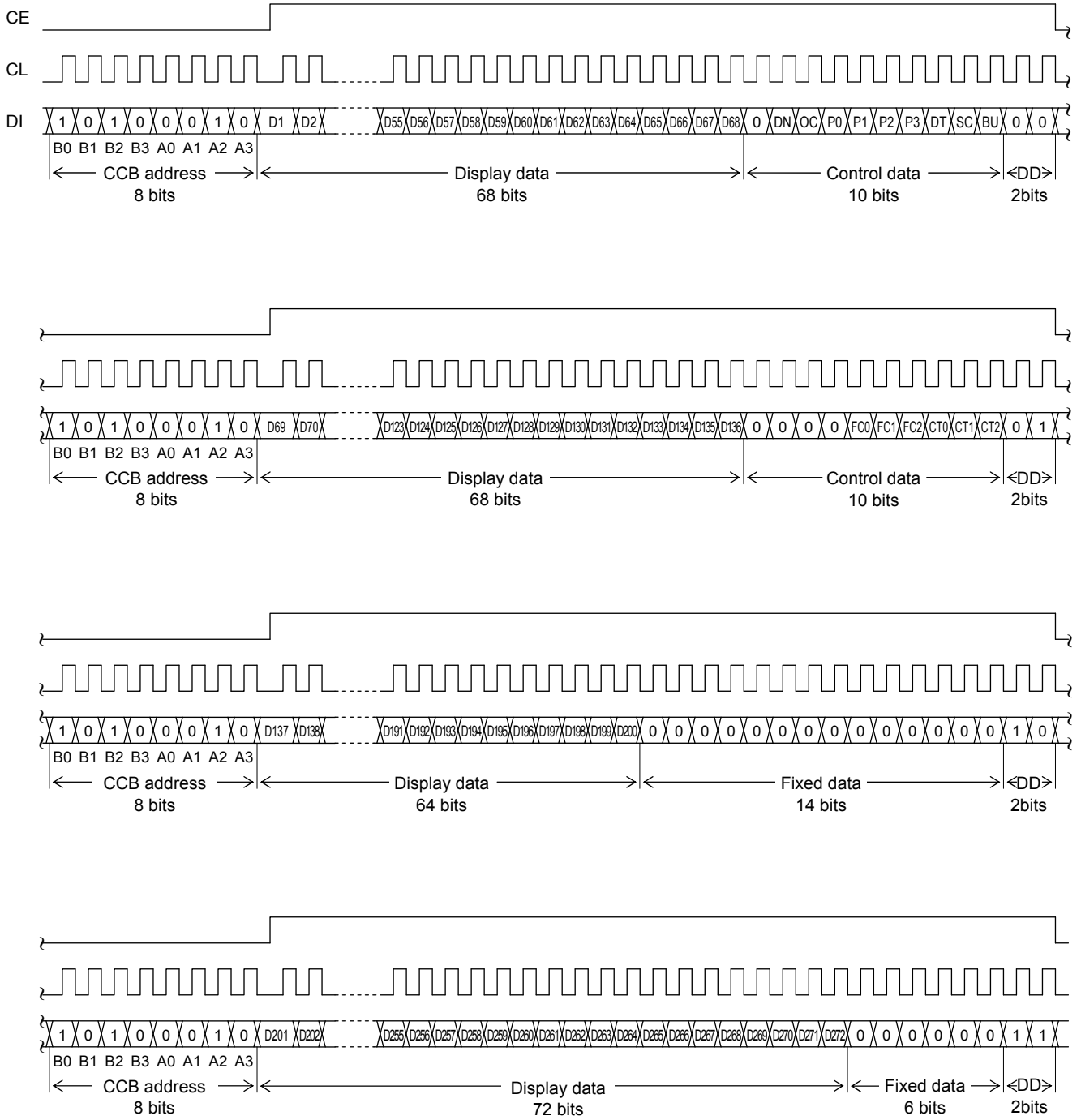

Note: DD is the direction data.

LC75879PT

(2) When CL is stopped at the high level

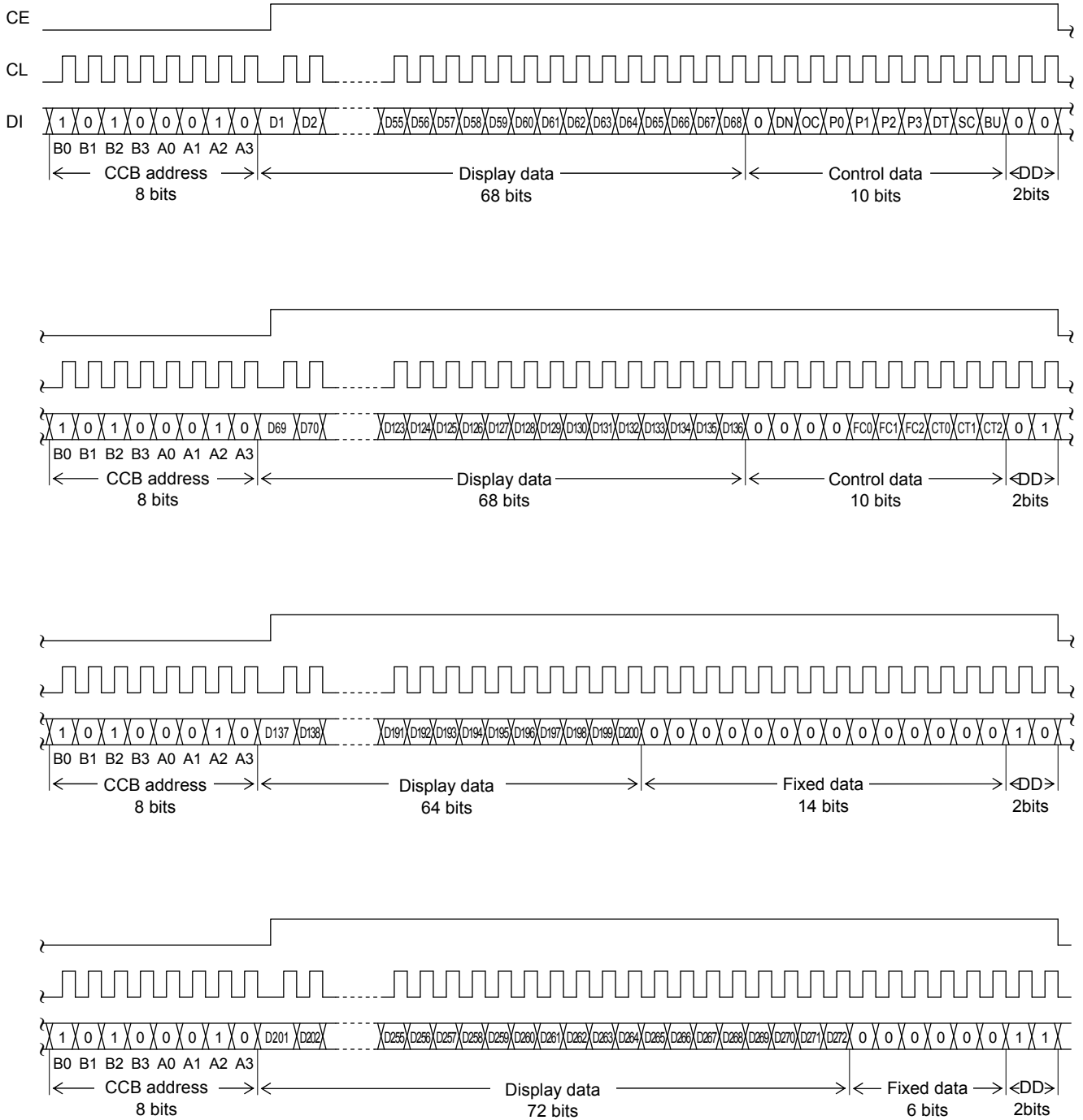

Note: DD is the direction data.

- CCB address "45H"
- D1 to D272 Display data
- DN S68 pin and S69/OSCI pin state setting control data
- OC Internal oscillator operating mode/external clock operating mode switching control data
- P0 to P3 Segment output port/general-purpose output port switching control data
- DT 1/4-duty 1/3-bias drive or 1/3-duty 1/3-bias drive switching control data
- SC Segment on/off control data
- BU Normal mode/power-saving mode control data
- FC0 to FC2 Common/segment output waveform frame frequency setting control data
- CT0 to CT2 Display contrast setting control data

LC75879PT

4. 1/3 duty (Simple mode transfer) (1) When CL is stopped at the low level

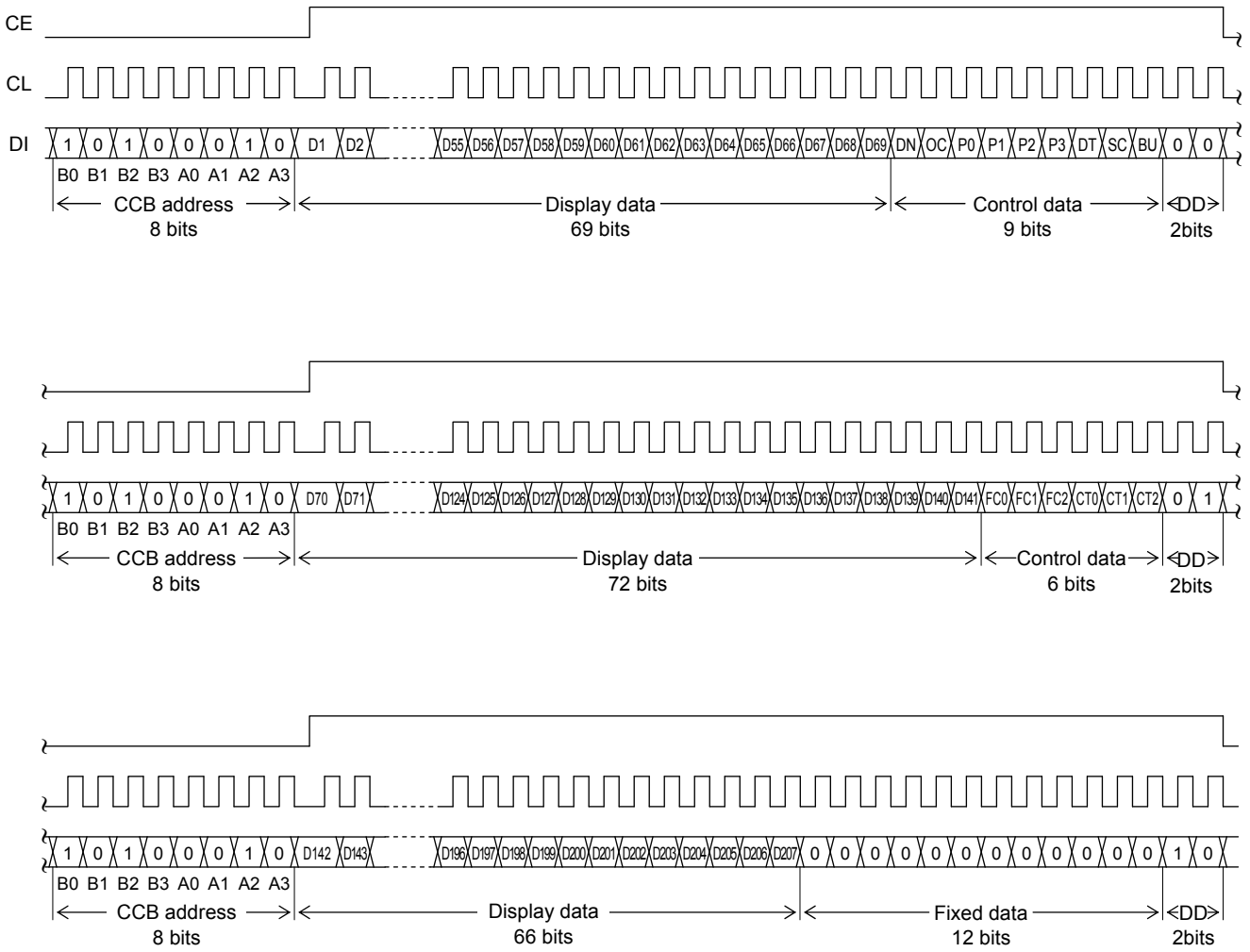

Note: DD is the direction data.

LC75879PT

(2) When CL is stopped at the high level

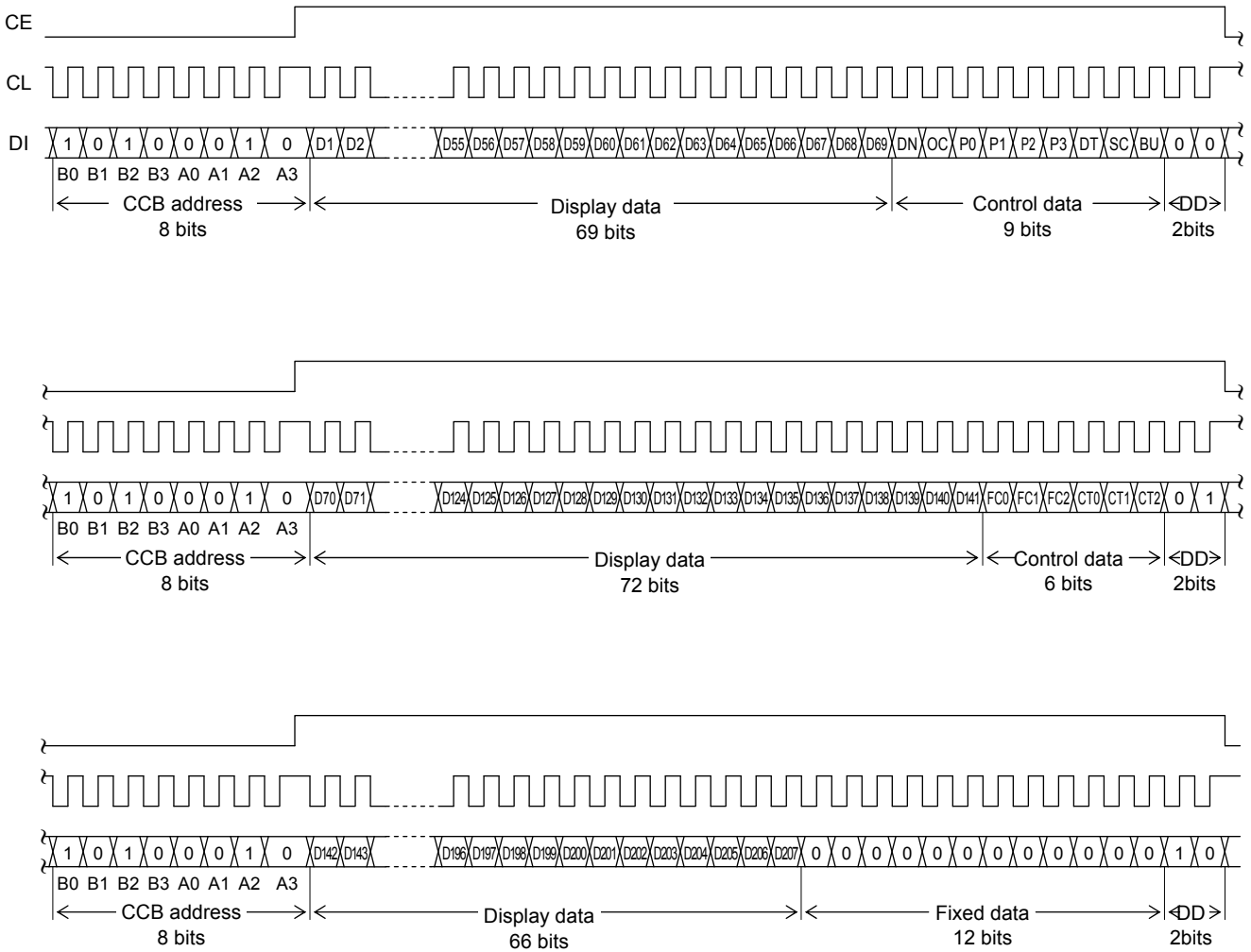

Note: DD is the direction data

- CCB address “45H”
- D1 to D207 Display data
- DN S68 pin and S69/OSCI pin state setting control data
- OC Internal oscillator operating mode/external clock operating mode switching control data
- P0 to P3 Segment output port/general-purpose output port switching control data
- DT 1/4-duty 1/3-bias drive or 1/3-duty 1/3-bias drive switching control data
- SC Segment on/off control data
- BU Normal mode/power-saving mode control data
- FC0 to FC2 Common/segment output waveform frame frequency setting control data
- CT0 to CT2 Display contrast setting control data

Serial Data Transfer Example

(1) 1/4 duty

- When 201 or more segments are used
All 352 bits of serial data must be sent.

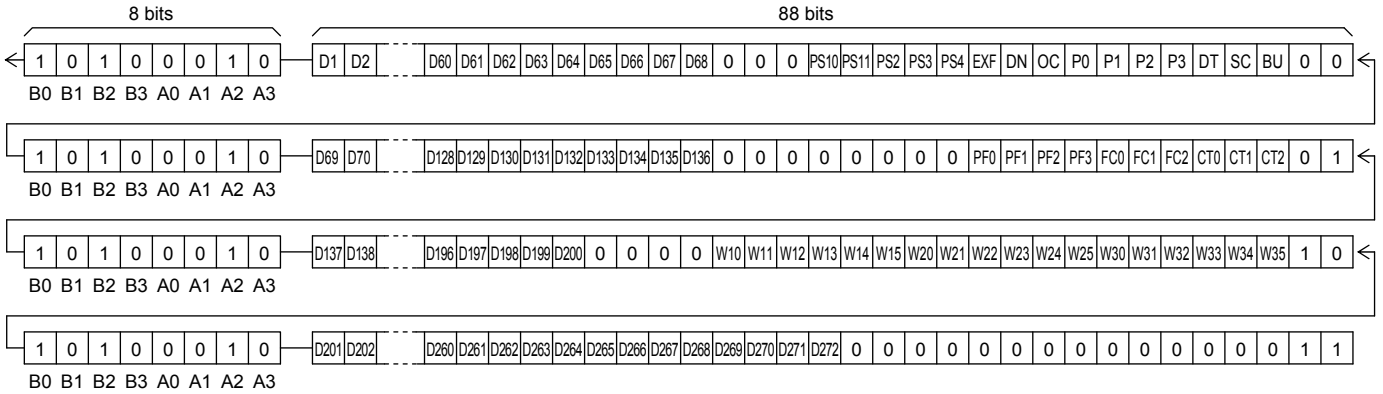

- When fewer than 201 segments are used
The 264 bits of serial data must be sent.
However, the serial data shown below (the D1 to D200 display data and the control data) must always be sent.

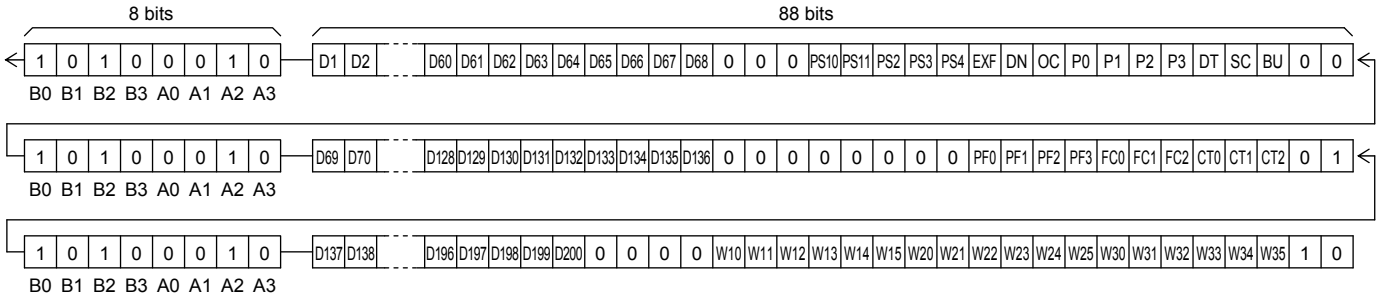

2. 1/3 duty

All 264 bits of serial data must be sent.

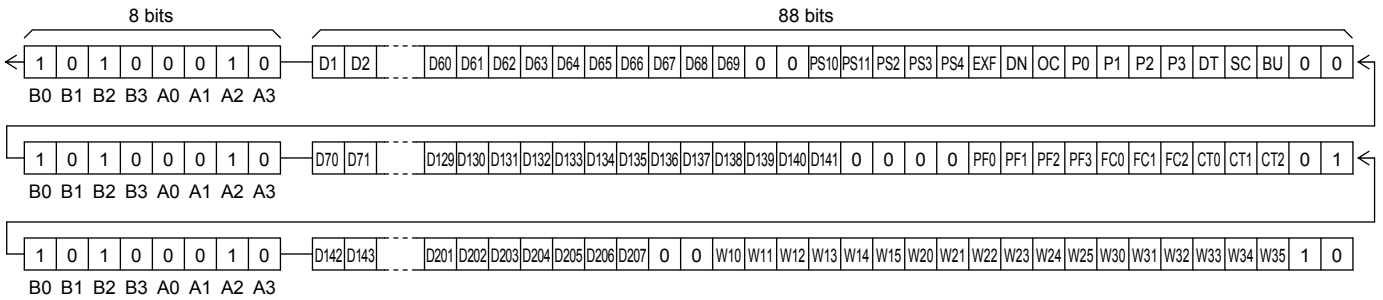

LC75879PT

3. 1/4 duty (Simple mode transfer)

- When 201 or more segments are used
All 320 bits of serial data must be sent.

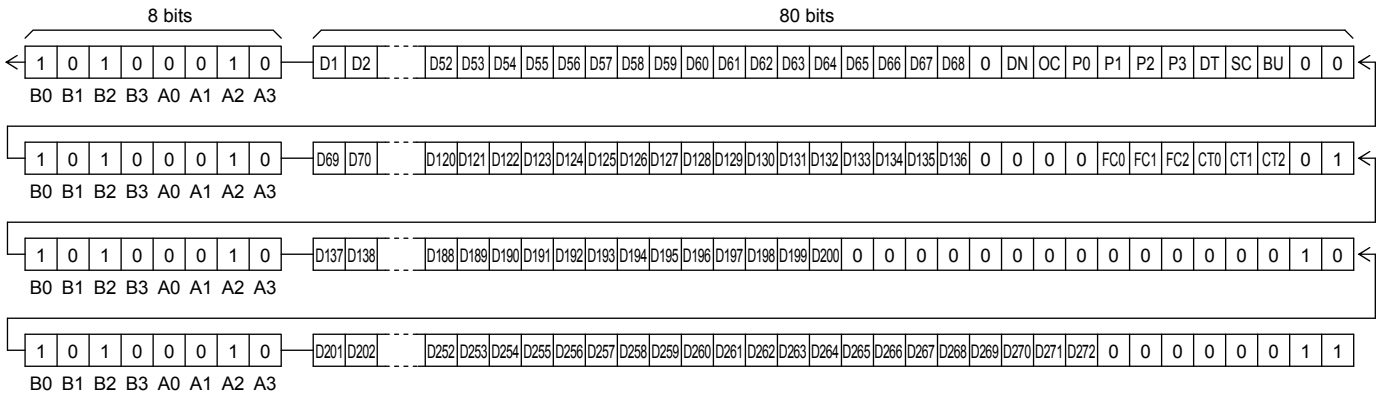

- When fewer than 201 segments are used
Either 160 or 240 bits of serial data must be sent, depending on the number of segments to be used.
However, the serial data shown below (the D1 to D136 display data and the control data) must always be sent.

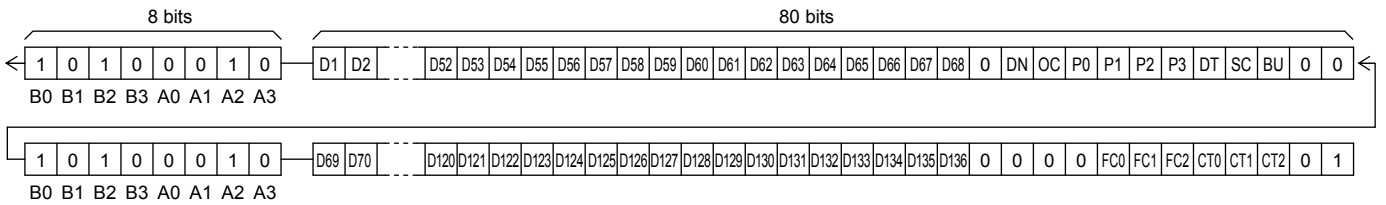

4. 1/3 duty (Simple mode transfer)

- When 142 or more segments are used
All 240 bits of serial data must be sent.

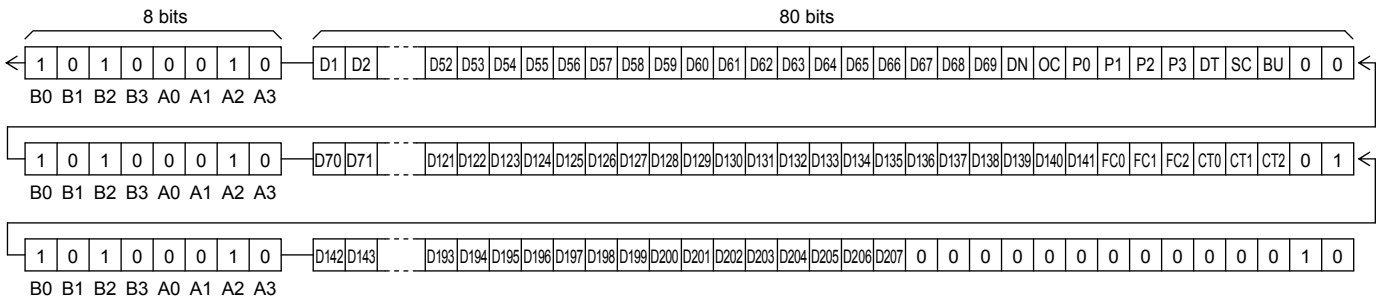

- When fewer than 142 segments are used
The 160 bits of serial data must be sent.
However, the serial data shown below (the D1 to D141 display data and the control data) must always be sent.

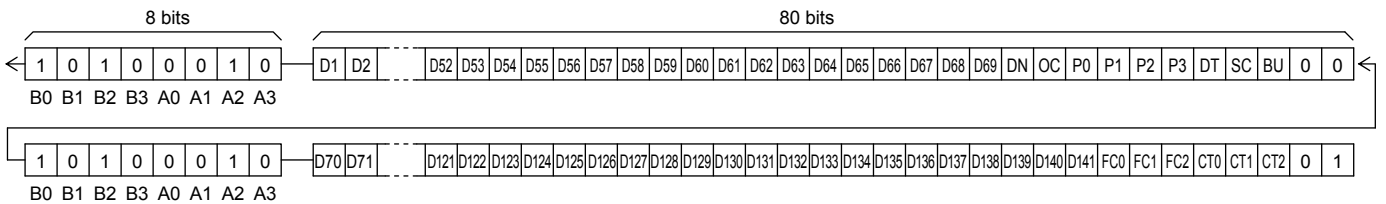

Control Data Functions

(1) PS10 and PS11, PS2 to PS4 ... General-purpose output port (P1 to P4) function setting control data

These control data bits set the general-purpose output function (High or low level output), clock output function or PWM output function of the P1 output pin, and the general-purpose output function (High or low level output) or PWM output function of the P2 to P4 output pins.

However, be careful of being unable to set a PWM output function when the external clock operating frequency is set the $f_{CK2} = 38[\text{kHz}]$ typ (EXF = "1") in external clock operating mode (OC = "1").

In addition, be careful of setting of the general-purpose output function (High or low level output) in the case of the simple mode transfer forcibly.

PS10	PS11	General-purpose output port (P1) function
0	0	General-purpose output function (High or low level output)
1	0	Clock output function (Clock frequency : $f_{osc}/2, f_{CK}/2$)
0	1	Clock output function (Clock frequency : $f_{osc}/8, f_{CK}/8$)
1	1	PWM output function (Support for PWM data W10 to W15)

PS2	General-purpose output port (P2) function
0	General-purpose output function (High or low level output)
1	PWM output function (Support for PWM data W20 to W25)

PS3	General-purpose output port (P3) function
0	General-purpose output function (High or low level output)
1	PWM output function (Support for PWM data W30 to W35)

PS4	General-purpose output port (P4) function
0	General-purpose output function (High or low level output)
1	PWM output function (Support for PWM data W10 to W15)

(2) EXF ... External clock operating frequency setting control data

This control data bit sets the operating frequency of the external clock which input into the OSCI pin, when the external clock operating mode (OC = "1") is set. However, be careful of setting the $f_{CK1} = 300[\text{kHz}]$ typ when the external clock operating mode (OC = "1") is set in the case of the simple mode transfer forcibly. In addition, this data is effective only when external clock operating mode (OC = "1") is set.

EXF	External clock operating frequency $f_{CK}[\text{kHz}]$
0	$f_{CK1}=300[\text{kHz}]$ typ
1	$f_{CK2}=38[\text{kHz}]$ typ

(3) DN ... S68 pin and S69/OSCI pin state setting control data

This control data bit sets state of the S68 pin and the S69/OSCI pin.

DN	Number of display segments		Pin state	
	1/4 duty	1/3 duty	S68	S69/OSCI
0	Up to 264 segments	Up to 201 segment	"L"(V _{SS})	"L"(V _{SS})/OSCI
1	Up to 272 segments	Up to 207 segment	S68	S69/OSCI

Note: "L" (V_{SS}) : Low (V_{SS}) level output

S68 : Segment output

"L" (V_{SS})/OSCI : Low (V_{SS}) level output in internal oscillator operating mode (OC = 0)
External clock input in external clock operating mode (OC = 1)

S69/OSCI : Segment output in internal oscillator operating mode (OC = 0)
External clock input in external clock operating mode (OC = 1)

LC75879PT

(4) OC ... Internal oscillator operating mode/external clock operating mode switching control data

This control data bit selects either the internal oscillator operating mode or external clock operating mode.

OC	Fundamental clock operating mode	I/O pin (S69/OSCI) state
0	Internal oscillator operating mode	S69
1	External clock operating mode	OSCI

Note: S69 : Segment output
OSCI : External clock input

(5) P0 to P3 ... Segment output port/general-purpose output port switching control data

These control data bits switch the segment output port/general-purpose output port functions of the S1/P1 to S8/P8 output pins.

Control data				Output pin state							
P0	P1	P2	P3	S1/P1	S2/P2	S3/P3	S4/P4	S5/P5	S6/P6	S7/P7	S8/P8
0	0	0	0	S1	S2	S3	S4	S5	S6	S7	S8
0	0	0	1	P1	S2	S3	S4	S5	S6	S7	S8
0	0	1	0	P1	P2	S3	S4	S5	S6	S7	S8
0	0	1	1	P1	P2	P3	S4	S5	S6	S7	S8
0	1	0	0	P1	P2	P3	P4	S5	S6	S7	S8
0	1	0	1	P1	P2	P3	P4	P5	S6	S7	S8
0	1	1	0	P1	P2	P3	P4	P5	P6	S7	S8
0	1	1	1	P1	P2	P3	P4	P5	P6	P7	S8
1	0	0	0	P1	P2	P3	P4	P5	P6	P7	P8

Note1: Sn(n=1 to 8): Segment output ports

Pn(n=1 to 8): General-purpose output ports

Note2: When are setting (P0,P1,P2,P3)=(1,0,0,1), (1,0,1,0), (1,0,1,1) and (1,1,X,X), the all P1/S1 to P8/S8 output pins selects the segment output port.
X: don't care

The table below lists the correspondence between the display data and the output pins when these pins are selected to be general-purpose output ports (general-purpose output function).

Output pin	Correspondence display data	
	1/4 duty	1/3 duty
S1/P1	D1	D1
S2/P2	D5	D4
S3/P3	D9	D7
S4/P4	D13	D10
S5/P5	D17	D13
S6/P6	D21	D16
S7/P7	D25	D19
S8/P8	D29	D22

For example, if the circuit is operated in 1/4 duty and the S4/P4 output pin is selected to be a general-purpose output port and is set general-purpose output function, the S4/P4 output pin will output a high level when the display data D13 is 1, and will output a low level when D13 is 0.

(6) DT ... 1/4-duty 1/3-bias drive or 1/3-duty 1/3-bias drive switching control data

This control data bit selects either 1/4-duty 1/3-bias drive or 1/3-duty 1/3-bias drive.

DT	Drive scheme	The COM4/S67 pin state
0	1/4-duty 1/3-bias drive	COM4
1	1/3-duty 1/3-bias drive	S67

Note: COM4 : Common output
S67 : Segment output

(7) SC ... Segment on/off control data

This control data bit controls the on/off state of the segments.

SC	Display state
0	On
1	Off

Note that when the segments are turned off by setting SC to 1, the segments are turned off by outputting segment off waveforms from the segment output pins.

(8) BU ... Normal mode/power-saving mode control data

This control data bit selects either normal mode or power-saving mode.

BU	Mode
0	Normal mode
1	Power saving mode In this mode, the internal oscillator circuit stops oscillation (the S69/OSCI pin is configured for segment output) if the IC is in the internal oscillator operating mode (OC=0) and the IC stops receiving external clock signals (the S69/OSCI pin is configured for external clock input) if the IC is in the external clock operating mode (OC=1). The common and segment output pins go to the V _{SS} level. However, the S1/P1 to S8/P8 output pins can be used as general-purpose output ports under the control of the data bits P0 to P3. (The general-purpose output port P1 to P4 can not be used as clock output or PWM output).

(9) PF0 to PF3 ... PWM output waveform frame frequency setting control data

These control data bits set the frame frequency of the PWM output waveforms. However, when the PWM output function isn't used, these control data bits become invalid. In addition, when the external clock operating frequency is set the f_{CK2} = 38[kHz] typ (EXF = "1") in external clock operating mode (OC = "1") or when the serial data transfer is the simple mode transfer, these control data bits become invalid.

Control data				PWM output waveform frame frequency fp[Hz]	
PF0	PF1	PF2	PF3	Internal oscillator operating mode (The control data OC is 0, fosc=300[kHz] typ)	External clock operating mode (The control data OC is 1 and EXF is 0, f _{CK1} =300[kHz] typ)
0	0	0	0	fosc/1536	f _{CK1} /1536
1	0	0	0	fosc/1408	f _{CK1} /1408
0	1	0	0	fosc/1280	f _{CK1} /1280
1	1	0	0	fosc/1152	f _{CK1} /1152
0	0	1	0	fosc/1024	f _{CK1} /1024
1	0	1	0	fosc/896	f _{CK1} /896
0	1	1	0	fosc/768	f _{CK1} /768
1	1	1	0	fosc/640	f _{CK1} /640
0	0	0	1	fosc/512	f _{CK1} /512
1	0	0	1	fosc/384	f _{CK1} /384
0	1	0	1	fosc/256	f _{CK1} /256

Note : When is setting (PF0,PF1,PF2,PF3) = (1,1,0,1) and (X,X,1,1), the frame frequency is same as frame frequency at the time of the (PF0,PF1,PF2,PF3) = (1,0,1,0) setting (fosc/896, f_{CK1}/896).

X: don't care

LC75879PT

(10) FC0 to FC2 ... Common/segment output waveform frame frequency control data

These control data bits set the frame frequency of the common and segment output waveforms.

Control data			Common/segment output waveform frame frequency fo[Hz]		
FC0	FC1	FC2	Internal oscillator operating mode (The control data OC is 0, fosc=300[kHz] typ)	External clock operating mode (The control data OC is 1 and EXF is 0, f _{CK1} =300[kHz] typ)	External clock operating mode (The control data OC is 1 and EXF is 1, f _{CK2} =38[kHz] typ)
1	1	0	fosc/6144	f _{CK1} /6144	f _{CK2} /768
1	1	1	fosc/4608	f _{CK1} /4608	f _{CK2} /576
0	0	0	fosc/3072	f _{CK1} /3072	f _{CK2} /384
0	0	1	fosc/2304	f _{CK1} /2304	f _{CK2} /288
0	1	0	fosc/1536	f _{CK1} /1536	f _{CK2} /192
0	1	1	fosc/1152	f _{CK1} /1152	f _{CK2} /144
1	0	0	fosc/768	f _{CK1} /768	f _{CK2} /96

Note: When is setting (FC0,FC1,FC2) = (1,0,1), the frame frequency is same as frame frequency at the time of the (FC0,FC1,FC2) = (0,0,0) setting (fosc/3072, f_{CK1}/3072, f_{CK2}/384).

(11) CT0 to CT2 ... Display contrast setting control data

These control data bits set display contrast.

CT0 to CT2: Sets the display contrast (7 steps)

CT0	CT1	CT2	LCD drive 3/3 bias voltage V _{DD0} level
0	0	0	1.00V _{DD} =V _{DD} -(0.05V _{DD} ×0)
1	0	0	0.95V _{DD} =V _{DD} -(0.05V _{DD} ×1)
0	1	0	0.90V _{DD} =V _{DD} -(0.05V _{DD} ×2)
1	1	0	0.85V _{DD} =V _{DD} -(0.05V _{DD} ×3)
0	0	1	0.80V _{DD} =V _{DD} -(0.05V _{DD} ×4)
1	0	1	0.75V _{DD} =V _{DD} -(0.05V _{DD} ×5)
0	1	1	0.70V _{DD} =V _{DD} -(0.05V _{DD} ×6)

Note: When is setting (CT0,CT1,CT2) = (1,1,1), the LCD drive 3/3 bias voltage V_{DD0} level is 1.00V_{DD}.

Note that although the display contrast can be adjusted by operating the built-in display contrast adjustment circuit, it can also be adjusted by modifying the supply pin V_{DD} voltage level.

LC75879PT

(12) W10 to W15, W20 to W25, W30 to W35 PWM data of the PWM output

These control data bits set the pulse width of the PWM output P1 to P4. However, when the PWM output function isn't used, these control data bits become invalid. In addition, when the external clock operating frequency is set the $f_{CK2} = 38[\text{kHz}]$ typ (EXF = "1") in external clock operating mode (OC = "1") or when the serial data transfer is the simple mode transfer, these control data bits become invalid.

Wn0	Wn1	Wn2	Wn3	Wn4	Wn5	Pulse width of PWM output	Wn0	Wn1	Wn2	Wn3	Wn4	Wn5	Pulse width of PWM output
0	0	0	0	0	0	(1/64)×Tp	0	0	0	0	0	1	(33/64)×Tp
1	0	0	0	0	0	(2/64)×Tp	1	0	0	0	0	1	(34/64)×Tp
0	1	0	0	0	0	(3/64)×Tp	0	1	0	0	0	1	(35/64)×Tp
1	1	0	0	0	0	(4/64)×Tp	1	1	0	0	0	1	(36/64)×Tp
0	0	1	0	0	0	(5/64)×Tp	0	0	1	0	0	1	(37/64)×Tp
1	0	1	0	0	0	(6/64)×Tp	1	0	1	0	0	1	(38/64)×Tp
0	1	1	0	0	0	(7/64)×Tp	0	1	1	0	0	1	(39/64)×Tp
1	1	1	0	0	0	(8/64)×Tp	1	1	1	0	0	1	(40/64)×Tp
0	0	0	1	0	0	(9/64)×Tp	0	0	0	1	0	1	(41/64)×Tp
1	0	0	1	0	0	(10/64)×Tp	1	0	0	1	0	1	(42/64)×Tp
0	1	0	1	0	0	(11/64)×Tp	0	1	0	1	0	1	(43/64)×Tp
1	1	0	1	0	0	(12/64)×Tp	1	1	0	1	0	1	(44/64)×Tp
0	0	1	1	0	0	(13/64)×Tp	0	0	1	1	0	1	(45/64)×Tp
1	0	1	1	0	0	(14/64)×Tp	1	0	1	1	0	1	(46/64)×Tp
0	1	1	1	0	0	(15/64)×Tp	0	1	1	1	0	1	(47/64)×Tp
1	1	1	1	0	0	(16/64)×Tp	1	1	1	1	0	1	(48/64)×Tp
0	0	0	0	1	0	(17/64)×Tp	0	0	0	0	1	1	(49/64)×Tp
1	0	0	0	1	0	(18/64)×Tp	1	0	0	0	1	1	(50/64)×Tp
0	1	0	0	1	0	(19/64)×Tp	0	1	0	0	1	1	(51/64)×Tp
1	1	0	0	1	0	(20/64)×Tp	1	1	0	0	1	1	(52/64)×Tp
0	0	1	0	1	0	(21/64)×Tp	0	0	1	0	1	1	(53/64)×Tp
1	0	1	0	1	0	(22/64)×Tp	1	0	1	0	1	1	(54/64)×Tp
0	1	1	0	1	0	(23/64)×Tp	0	1	1	0	1	1	(55/64)×Tp
1	1	1	0	1	0	(24/64)×Tp	1	1	1	0	1	1	(56/64)×Tp
0	0	0	1	1	0	(25/64)×Tp	0	0	0	1	1	1	(57/64)×Tp
1	0	0	1	1	0	(26/64)×Tp	1	0	0	1	1	1	(58/64)×Tp
0	1	0	1	1	0	(27/64)×Tp	0	1	0	1	1	1	(59/64)×Tp
1	1	0	1	1	0	(28/64)×Tp	1	1	0	1	1	1	(60/64)×Tp
0	0	1	1	1	0	(29/64)×Tp	0	0	1	1	1	1	(61/64)×Tp
1	0	1	1	1	0	(30/64)×Tp	1	0	1	1	1	1	(62/64)×Tp
0	1	1	1	1	0	(31/64)×Tp	0	1	1	1	1	1	(63/64)×Tp
1	1	1	1	1	0	(32/64)×Tp	1	1	1	1	1	1	(64/64)×Tp

Note: W10 to W15 ... PWM data of the output pin S1/P1 and S4/P4

W20 to W25 ... PWM data of the output pin S2/P2

W30 to W35 ... PWM data of the output pin S3/P3

$$T_p = \frac{1}{f_p}$$

LC75879PT

Display Data and Output Pin Correspondence (1/4 Duty)

Output pin	COM1	COM2	COM3	COM4
S1/P1	D1	D2	D3	D4
S2/P2	D5	D6	D7	D8
S3/P3	D9	D10	D11	D12
S4/P4	D13	D14	D15	D16
S5/P5	D17	D18	D19	D20
S6/P6	D21	D22	D23	D24
S7/P7	D25	D26	D27	D28
S8/P8	D29	D30	D31	D32
S9	D33	D34	D35	D36
S10	D37	D38	D39	D40
S11	D41	D42	D43	D44
S12	D45	D46	D47	D48
S13	D49	D50	D51	D52
S14	D53	D54	D55	D56
S15	D57	D58	D59	D60
S16	D61	D62	D63	D64
S17	D65	D66	D67	D68
S18	D69	D70	D71	D72
S19	D73	D74	D75	D76
S20	D77	D78	D79	D80
S21	D81	D82	D83	D84
S22	D85	D86	D87	D88
S23	D89	D90	D91	D92
S24	D93	D94	D95	D96
S25	D97	D98	D99	D100
S26	D101	D102	D103	D104
S27	D105	D106	D107	D108
S28	D109	D110	D111	D112
S29	D113	D114	D115	D116
S30	D117	D118	D119	D120
S31	D121	D122	D123	D124
S32	D125	D126	D127	D128
S33	D129	D130	D131	D132
S34	D133	D134	D135	D136

Output pin	COM1	COM2	COM3	COM4
S35	D137	D138	D139	D140
S36	D141	D142	D143	D144
S37	D145	D146	D147	D148
S38	D149	D150	D151	D152
S39	D153	D154	D155	D156
S40	D157	D158	D159	D160
S41	D161	D162	D163	D164
S42	D165	D166	D167	D168
S43	D169	D170	D171	D172
S44	D173	D174	D175	D176
S45	D177	D178	D179	D180
S46	D181	D182	D183	D184
S47	D185	D186	D187	D188
S48	D189	D190	D191	D192
S49	D193	D194	D195	D196
S50	D197	D198	D199	D200
S51	D201	D202	D203	D204
S52	D205	D206	D207	D208
S53	D209	D210	D211	D212
S54	D213	D214	D215	D216
S55	D217	D218	D219	D220
S56	D221	D222	D223	D224
S57	D225	D226	D227	D228
S58	D229	D230	D231	D232
S59	D233	D234	D235	D236
S60	D237	D238	D239	D240
S61	D241	D242	D243	D244
S62	D245	D246	D247	D248
S63	D249	D250	D251	D252
S64	D253	D254	D255	D256
S65	D257	D258	D259	D260
S66	D261	D262	D263	D264
S68	D265	D266	D267	D268
S69/OSCI	D269	D270	D271	D272

Note: This table assumes that pins S1/P1 to S8/P8 and S69/OSCI are configured for segment output.

LC75879PT

For example, the table below lists the output states for the S21 output pin.

Display data				Output pin (S21) state
D81	D82	D83	D84	
0	0	0	0	The LCD segments corresponding to COM1, COM2, COM3, and COM4 are off.
0	0	0	1	The LCD segment corresponding to COM4 is on.
0	0	1	0	The LCD segment corresponding to COM3 is on.
0	0	1	1	The LCD segment corresponding to COM3 and COM4 are on.
0	1	0	0	The LCD segment corresponding to COM2 is on.
0	1	0	1	The LCD segment corresponding to COM2 and COM4 are on.
0	1	1	0	The LCD segment corresponding to COM2 and COM3 are on.
0	1	1	1	The LCD segments corresponding to COM2, COM3, and COM4 are on.
1	0	0	0	The LCD segment corresponding to COM1 is on.
1	0	0	1	The LCD segment corresponding to COM1 and COM4 are on.
1	0	1	0	The LCD segment corresponding to COM1 and COM3 are on.
1	0	1	1	The LCD segments corresponding to COM1, COM3, and COM4 are on.
1	1	0	0	The LCD segment corresponding to COM1 and COM2 are on.
1	1	0	1	The LCD segments corresponding to COM1, COM2, and COM4 are on.
1	1	1	0	The LCD segments corresponding to COM1, COM2, and COM3 are on.
1	1	1	1	The LCD segments corresponding to COM1, COM2, COM3, and COM4 are on.

Display Data and Output Pin Correspondence (1/3 Duty)

Output pin	COM1	COM2	COM3
S1/P1	D1	D2	D3
S2/P2	D4	D5	D6
S3/P3	D7	D8	D9
S4/P4	D10	D11	D12
S5/P5	D13	D14	D15
S6/P6	D16	D17	D18
S7/P7	D19	D20	D21
S8/P8	D22	D23	D24
S9	D25	D26	D27
S10	D28	D29	D30
S11	D31	D32	D33
S12	D34	D35	D36
S13	D37	D38	D39
S14	D40	D41	D42
S15	D43	D44	D45
S16	D46	D47	D48
S17	D49	D50	D51
S18	D52	D53	D54
S19	D55	D56	D57
S20	D58	D59	D60
S21	D61	D62	D63
S22	D64	D65	D66
S23	D67	D68	D69
S24	D70	D71	D72
S25	D73	D74	D75
S26	D76	D77	D78
S27	D79	D80	D81
S28	D82	D83	D84
S29	D85	D86	D87
S30	D88	D89	D90
S31	D91	D92	D93
S32	D94	D95	D96
S33	D97	D98	D99
S34	D100	D101	D102
S35	D103	D104	D105
S36	D106	D107	D108
S37	D109	D110	D111
S38	D112	D113	D114
S39	D115	D116	D117
S40	D118	D119	D120
S41	D121	D122	D123
S42	D124	D125	D126
S43	D127	D128	D129
S44	D130	D131	D132
S45	D133	D134	D135
S46	D136	D137	D138
S47	D139	D140	D141
S48	D142	D143	D144
S49	D145	D146	D147
S50	D148	D149	D150
S51	D151	D152	D153
S52	D154	D155	D156
S53	D157	D158	D159
S54	D160	D161	D162
S55	D163	D164	D165
S56	D166	D167	D168
S57	D169	D170	D171
S58	D172	D173	D174
S59	D175	D176	D177
S60	D178	D179	D180
S61	D181	D182	D183
S62	D184	D185	D186
S63	D187	D188	D189
S64	D190	D191	D192
S65	D193	D194	D195
S66	D196	D197	D198
S67/COM4	D199	D200	D201
S68	D202	D203	D204
S69/OSCI	D205	D206	D207

Note: This table assumes that pins S1/P1 to S8/P8, S67/COM4 and S69/OSCI are configured for segment output.

LC75879PT

For example, the table below lists the output states for the S21 output pin.

Display data			Output pin (S21) state
D61	D62	D63	
0	0	0	The LCD segments corresponding to COM1, COM2, and COM3 are off.
0	0	1	The LCD segment corresponding to COM3 is on.
0	1	0	The LCD segment corresponding to COM2 is on.
0	1	1	The LCD segment corresponding to COM2 and COM3 are on.
1	0	0	The LCD segment corresponding to COM1 is on.
1	0	1	The LCD segment corresponding to COM1 and COM3 are on.
1	1	0	The LCD segment corresponding to COM1 and COM2 are on.
1	1	1	The LCD segments corresponding to COM1, COM2, and COM3 are on.