



Chipsmall Limited consists of a professional team with an average of over 10 year of expertise in the distribution of electronic components. Based in Hongkong, we have already established firm and mutual-benefit business relationships with customers from,Europe,America and south Asia,supplying obsolete and hard-to-find components to meet their specific needs.

With the principle of "Quality Parts,Customers Priority,Honest Operation,and Considerate Service",our business mainly focus on the distribution of electronic components. Line cards we deal with include Microchip,ALPS,ROHM,Xilinx,Pulse,ON,Everlight and Freescale. Main products comprise IC,Modules,Potentiometer,IC Socket,Relay,Connector.Our parts cover such applications as commercial,industrial, and automotives areas.

We are looking forward to setting up business relationship with you and hope to provide you with the best service and solution. Let us make a better world for our industry!



## Contact us

Tel: +86-755-8981 8866 Fax: +86-755-8427 6832

Email & Skype: info@chipsmall.com Web: www.chipsmall.com

Address: A1208, Overseas Decoration Building, #122 Zhenhua RD., Futian, Shenzhen, China



# LC87FBH08A

## 8-bit Microcontroller with 8K-byte Flash ROM and 256-byte RAM



ON Semiconductor®

www.onsemi.com

### Overview

The LC87FBH08A is an 8-bit microcontroller that, centered around a CPU running at a minimum bus cycle time of 83.3ns, integrates on a single chip a number of hardware features such as 8K-byte flash ROM (On-board-programmable), 256-byte RAM, an On-chip-debugger (flash versions only), sophisticated 16-bit timers/counters (may be divided into 8-bit timers), a 16-bit timer/counter (may be divided into 8-bit timers/counters or 8-bit PWMs), two 8-bit timers with a prescaler, a base timer serving as a time-of-day clock, a high-speed clock counter, a synchronous SIO interface, an asynchronous/synchronous SIO interface, a UART interface (full duplex), two 12-bit PWM channels, a 12-bit/8-bit 11-channel AD converter, a high-speed clock counter, a system clock frequency divider, an internal high-accuracy oscillator, a reference voltage generator circuit, an internal reset and a 20-source 10-vector interrupt feature.

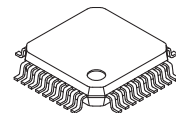

LQFP36 7x7 / QFP36

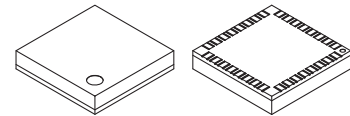

VQLP32 4x4  
[Build to order]

### Features

#### ■Flash ROM

- 8192 × 8 bits
- Capable of On-board programming with wide range (2.2 to 5.5V) of voltage source.
- Block-erasable in 128 byte units
- Writable in 2-byte units

#### ■RAM

- 256 × 9 bits

#### ■Minimum Bus Cycle

- 83.3ns (12MHz at  $V_{DD}=2.7V$  to 5.5V,  $T_a=-40^{\circ}C$  to  $+85^{\circ}C$ )
- 100ns (10MHz at  $V_{DD}=2.2V$  to 5.5V,  $T_a=-40^{\circ}C$  to  $+85^{\circ}C$ )
- 250ns ( 4MHz at  $V_{DD}=1.8V$  to 5.5V,  $T_a=-40^{\circ}C$  to  $+85^{\circ}C$ )

Note: The bus cycle time here refers to the ROM read speed.

\* This product is licensed from Silicon Storage Technology, Inc. (USA).

### ORDERING INFORMATION

See detailed ordering and shipping information on page 32 of this data sheet.

## LC87FBH08A

### ■ Minimum Instruction Cycle Time

- 250ns (12MHz at  $V_{DD}=2.7V$  to  $5.5V$ ,  $T_a=-40^{\circ}C$  to  $+85^{\circ}C$ )
- 300ns (10MHz at  $V_{DD}=2.2V$  to  $5.5V$ ,  $T_a=-40^{\circ}C$  to  $+85^{\circ}C$ )
- 750ns (4MHz at  $V_{DD}=1.8V$  to  $5.5V$ ,  $T_a=-40^{\circ}C$  to  $+85^{\circ}C$ )

### ■ Ports

- Normal withstand voltage I/O ports
  - Ports I/O direction can be designated in 1-bit units 17 (P1n, P20, P21, P30, P31, P70 to P73 CF2/XT2)
  - Ports I/O direction can be designated in 4-bit units 8 (P0n)
- Dedicated oscillator ports/input ports 1 (CF1/XT1)
- Reset pin 1 (RES)
- Power pins 3 (VSS1, VSS2, VDD1)

### ■ Timers

- Timer 0: 16-bit timer/counter with a capture register.
  - Mode 0: 8-bit timer with an 8-bit programmable prescaler (with an 8-bit capture register)  $\times$  2 channels
  - Mode 1: 8-bit timer with an 8-bit programmable prescaler (with an 8-bit capture register) + 8-bit counter (with an 8-bit capture register)
  - Mode 2: 16-bit timer with an 8-bit programmable prescaler (with a 16-bit capture register)
  - Mode 3: 16-bit counter (with a 16-bit capture register)
- Timer 1: 16-bit timer/counter that supports PWM/toggle outputs
  - Mode 0: 8-bit timer with an 8-bit prescaler (with toggle outputs) + 8-bit timer/counter with an 8-bit prescaler (with toggle outputs)
  - Mode 1: 8-bit PWM with an 8-bit prescaler  $\times$  2 channels
  - Mode 2: 16-bit timer/counter with an 8-bit prescaler (with toggle outputs) (toggle outputs also possible from the lower-order 8 bits)
  - Mode 3: 16-bit timer with an 8-bit prescaler (with toggle outputs) (The lower-order 8 bits can be used as PWM)
- Timer 6: 8-bit timer with a 6-bit prescaler (with toggle outputs)
- Timer 7: 8-bit timer with a 6-bit prescaler (with toggle outputs)
- Base timer
  - 1) The clock is selectable from the subclock (32.768kHz crystal oscillation), system clock, and timer 0 prescaler output.
  - 2) Interrupts are programmable in 5 different time schemes

### ■ High-speed Clock Counter

- Can count clocks with a maximum clock rate of 20MHz (at a main clock of 10MHz).
- Can generate output real time.

### ■ SIO

- SIO0: 8-bit synchronous serial interface
  - 1) LSB first/MSB first mode selectable
  - 2) Built-in 8-bit baudrate generator (maximum transfer clock cycle =  $4/3 t_{CYC}$ )
  - 3) Automatic continuous data transmission (1 to 256 bits, specifiable in 1 bit units, suspension and resumption of data transmission possible in 1 byte units)
- SIO1: 8-bit asynchronous/synchronous serial interface
  - Mode 0: Synchronous 8-bit serial I/O (2- or 3-wire configuration, 2 to 512  $t_{CYC}$  transfer clocks)
  - Mode 1: Asynchronous serial I/O (half-duplex, 8 data bits, 1 stop bit, 8 to 2048  $t_{CYC}$  baudrates)
  - Mode 2: Bus mode 1 (start bit, 8 data bits, 2 to 512  $t_{CYC}$  transfer clocks)
  - Mode 3: Bus mode 2 (start detect, 8 data bits, stop detect)

### ■ UART1

- Full duplex
- 7/8/9 bit data bits selectable
- 1 stop bit (2-bit in continuous data transmission)
- Built-in baudrate generator

## LC87FBH08A

- AD converter: 12 bits/8 bits × 11 channels
  - Successive approximation
  - 12 bits/8 bits AD converter resolution selectable
  - Port input: 10 channels, Reference voltage input: 1 channel
  
- PWM: Multifrequency 12-bit PWM × 2 channels
  
- Reference voltage generator circuit (VREF17)
  - Capable of monitoring the power supply voltage by AD conversion of frequency variable RC oscillator circuit's reference voltage.
  
- Remote Control Receiver Circuit (sharing pins with P73, INT3, and T0IN)
  - Noise rejection function (noise filter time constant selectable from 1 tCYC, 32 tCYC, and 128 tCYC)
  
- Clock Output Function
  - Capable generating clock outputs with a frequency of 1/1, 1/2, 1/4, 1/8, 1/16, 1/32, 1/64 of the source clock selected as the system clock.
  - Capable of generating the source clock for the subclock.
  
- Watchdog Timer
  - Capable of generating an internal reset on an overflow of a timer running on the low-speed RC oscillator clock or subclock.
  - Operating mode at standby is selectable from 3 modes (continue counting/stop operation/stop counting with a count value held).

### ■ Interrupts

- 20 sources, 10 vector addresses
  - 1) Provides three levels (low (L), high (H), and highest (X)) of multiplex interrupt control. Any interrupt requests of the level equal to or lower than the current interrupt are not accepted.
  - 2) When interrupt requests to two or more vector addresses occur at the same time, the interrupt of the highest level takes precedence over the other interrupts. For interrupts of the same level, the interrupt into the smallest vector address takes precedence.

No.	Vector Address	Level	Interrupt Source
1	00003H	X or L	INT0
2	0000BH	X or L	INT1
3	00013H	H or L	INT2/T0L/INT4
4	0001BH	H or L	INT3/INT5/base timer
5	00023H	H or L	T0H
6	0002BH	H or L	T1L/T1H
7	00033H	H or L	SIO0/UART1 receive
8	0003BH	H or L	SIO1/UART1 transmit
9	00043H	H or L	ADC/T6/T7/ PWM4, PWM5
10	0004BH	H or L	Port 0

- Priority levels X > H > L
- Of interrupts of the same level, the one with the smallest vector address takes precedence.

### ■ Subroutine Stack Levels: 128levels (The stack is allocated in RAM.)

### ■ High-speed Multiplication/Division Instructions

- 16 bits × 8 bits (5 tCYC execution time)
- 24 bits × 16 bits (12 tCYC execution time)
- 16 bits ÷ 8 bits (8 tCYC execution time)
- 24 bits ÷ 16 bits (12 tCYC execution time)

## LC87FBH08A

### ■ Oscillation Circuits

- Internal oscillation circuits

- Low-speed RC oscillation circuit (SRC): For system clock / For Watchdog timer (100kHz)
- Medium-speed RC oscillation circuit (RC): For system clock (1MHz)
- Frequency variable RC oscillation circuit (MRC): For system clock (8MHz  $\pm$  1.5%, Ta=−10°C to +85°C)

- External oscillation circuits

- Hi-speed CF oscillation circuit (CF): For system clock, with internal Rf
  - Low speed crystal oscillation circuit (X'tal): For low-speed system clock / For Watchdog timer, with internal Rf
- 1) The CF and crystal oscillation circuits share the same pins. The active circuit is selected under program control.
  - 2) Both the CF and crystal oscillator circuits stop operation on a system reset. After reset is released, oscillation is stopped so start the oscillation operation by program.

### ■ System Clock Divider Function

- Can run on low current.
- The minimum instruction cycle selectable from 300ns, 600ns, 1.2 $\mu$ s, 2.4 $\mu$ s, 4.8 $\mu$ s, 9.6 $\mu$ s, 19.2 $\mu$ s, 38.4 $\mu$ s, and 76.8 $\mu$ s (at a main clock rate of 10MHz).

### ■ Internal Reset Function

- Power-on reset (POR) function

- 1) POR reset is generated only at power-on time.
- 2) The POR release level can be selected from 8 levels (1.67V, 1.97V, 2.07V, 2.37V, 2.57V, 2.87V, 3.86V, and 4.35V) through option configuration.

- Low-voltage detection reset (LVD) function

- 1) LVD and POR functions are combined to generate resets when power is turned on and when power voltage falls below a certain level.
- 2) The use or disuse of the LVD function and the low voltage threshold level (7 levels: 1.91V, 2.01V, 2.31V, 2.51V, 2.81V, 3.79V, 4.28V) can be selected by optional configuration.

### ■ Standby Function

- HALT mode: Halts instruction execution while allowing the peripheral circuits to continue operation.

- 1) Oscillation is not halted automatically.
- 2) There are four ways of resetting the HALT mode.
  - (1) Setting the reset pin to the low level
  - (2) System resetting by low-voltage detection
  - (3) System resetting by watchdog timer
  - (4) Occurrence of an interrupt

- HOLD mode: Suspends instruction execution and the operation of the peripheral circuits.

- 1) The CF, low-/medium-/ Frequency variable RC, and crystal oscillators automatically stop operation.  
Note: The oscillation of the low-speed RC oscillator is also controlled directly by the watchdog timer and its standby-mode-time oscillation is also controlled.
- 2) There are five ways of resetting the HOLD mode.
  - (1) Setting the reset pin to the lower level.
  - (2) System resetting by low-voltage detection
  - (3) System resetting by watchdog timer
  - (4) Having an interrupt source established at either INT0, INT1, INT2, INT4, INT5  
\* INT0 and INT1 HOLD mode reset is available only when level detection is set.
  - (5) Having an interrupt source established at port 0.

Continued on next page.

# LC87FBH08A

Continued from preceding page.

- X'tal HOLD mode: Suspends instruction execution and the operation of the peripheral circuits except the base timer.
  - 1) The CF, low-/medium-/ Frequency variable RC oscillators automatically stop operation.  
Note: The oscillation of the low-speed RC oscillator is also controlled directly by the watchdog timer and its standby-mode-time oscillation is also controlled.
  - 2) The state of crystal oscillation established when the X'tal HOLD mode is entered is retained.
  - 3) There are six ways of resetting the X'tal HOLD mode.
    - (1) Setting the reset pin to the low level.
    - (2) System resetting by watchdog timer or low-voltage detection.
    - (3) System resetting by watchdog timer or low-voltage detection.
    - (4) Having an interrupt source established at either INT0, INT1, INT2, INT4, INT5  
\* INT0 and INT1 HOLD mode reset is available only when level detection is set.
    - (5) Having an interrupt source established at port 0.
    - (6) Having an interrupt source established in the base timer circuit.  
Note: Available only when X'tal oscillation is selected.

## ■ Onchip Debugger (flash versions only)

- Supports software debugging with the microcontroller mounted on the target board.
- Software break setting
- Stepwise execution of instructions
- Real time RAM data monitoring function  
All the RAM data map contents can be monitored and rewritten on the screen when the program is running.  
(Part of the SFR data cannot be rewritten.)
- Two channels of on-chip debugger pins are available to be compatible with small pin count devices.  
DBGP0 (P0), DBGP1 (P1)

## ■ Data Security Function (flash versions only)

- Protects the program data stored in flash memory from unauthorized read or copy.  
Note: This data security function does not necessarily provide absolute data security.

## ■ Package Form

- QFP36(7mm×7mm) : Pb-Free and Halogen Free type
- VQLP32(4mm×4mm) : Pb-Free and Halogen Free type (Build-to-order)

## ■ Development Tools

- On-chip-debugger : (1) TCB87 TypeB + LC87FBH08A  
(2) TCB87 TypeC (3 wire version) + LC87FBH08A

## ■ Flash ROM Programming Boards

Package	Programming boards
QFP36 (7mm×7mm)	W87F24Q
VQLP32 (4mm×4mm)	(build-to-order )

## LC87FBH08A

### ■Flash ROM Programmer

Maker		Model	Supported version	Device
Flash Support Group, Inc. (FSG)	Single Programmer	AF9709/AF9709B/AF9709C (Including Ando Electric Co., Ltd. models)	Rev 03.28 or later	87F008SU
	Gang Programmer	AF9723/AF9723B(Main body) (Including Ando Electric Co., Ltd. models)	-	-
		AF9833(Unit) (Including Ando Electric Co., Ltd. models)	-	-
Flash Support Group, Inc. (FSG) + ON Semiconductor (Note 1)	In-circuit Programmer	AF9101/AF9103(Main body) (FSG models)	(Note 2)	-
		SIB87(Inter Face Driver) (ON Semiconductor model)		
ON Semiconductor	Single/Gang Programmer	SKK / SKK Type B / SKK Type C (SanyoFWS)	Application Version 1.07 or later	LC87FBH08
	In-circuit/Gang Programmer	SKK-DBG Type B / SKK-DBG Type C (SanyoFWS)	Chip Data Version 2.38 or later	

For information about AF-Series:

Flash Support Group, Inc.

TEL: +81-53-459-1050

E-mail: sales@j-fsg.co.jp

Note1: On-board-programmer from FSG (AF9101/AF9103) and serial interface driver from our company (SIB87) together can give a PC-less, standalone on-board-programming capabilities.

Note2: It needs a special programming devices and applications depending on the use of programming environment. Please ask FSG or our company for the information.

# LC87FBH08A

## Package Dimensions

unit : mm

LQFP36 7x7 / QFP36  
CASE 561AV  
ISSUE A

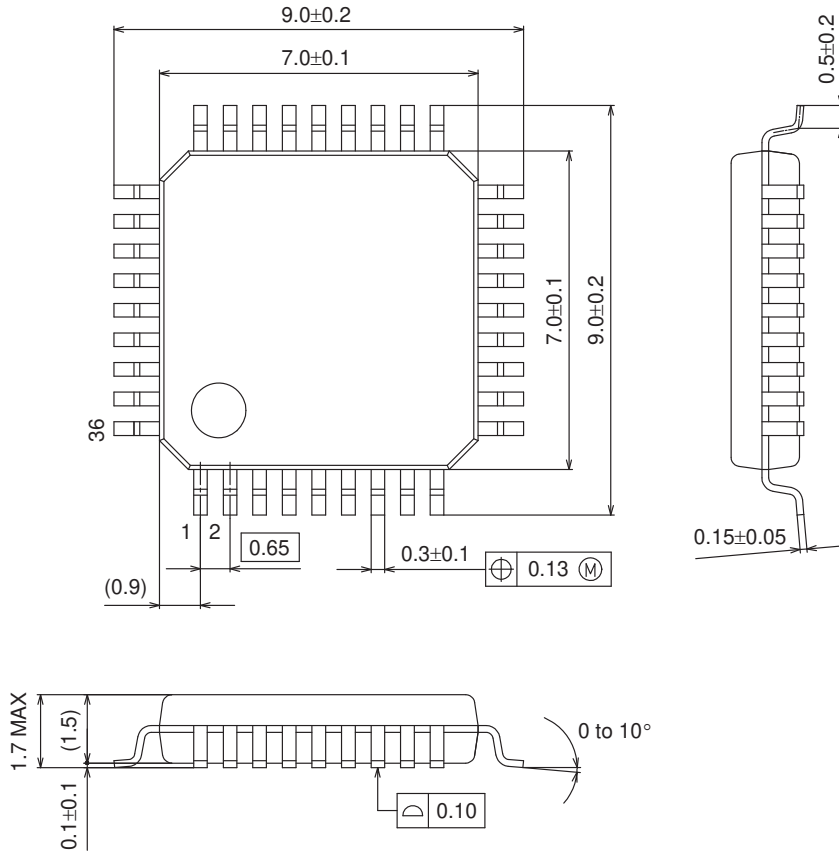

### SOLDERING FOOTPRINT\*

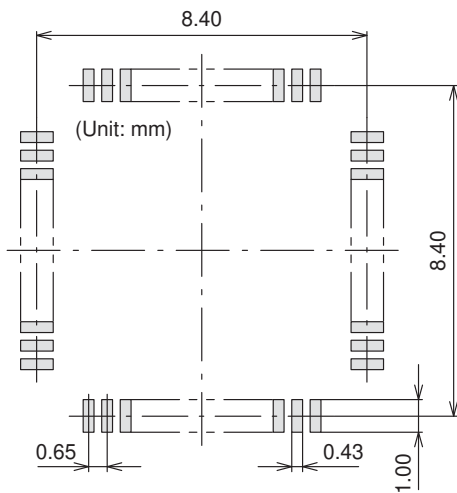

### GENERIC MARKING DIAGRAM\*

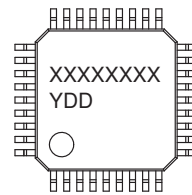

XXXXX = Specific Device Code  
Y = Year  
DD = Additional Traceability Data

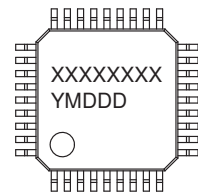

XXXXX = Specific Device Code  
Y = Year  
M = Month  
DDD = Additional Traceability Data

\*This information is generic. Please refer to device data sheet for actual part marking. Pb-Free indicator, "G" or microdot "▪", may or may not be present.

NOTE: The measurements are not to guarantee but for reference only.

\*For additional information on our Pb-Free strategy and soldering details, please download the ON Semiconductor Soldering and Mounting Techniques Reference Manual, SOLDERRM/D.



# LC87FBH08A

## Package Dimensions

unit : mm

[Build to order]

VQLP32 4x4  
CASE 602AE  
ISSUE A

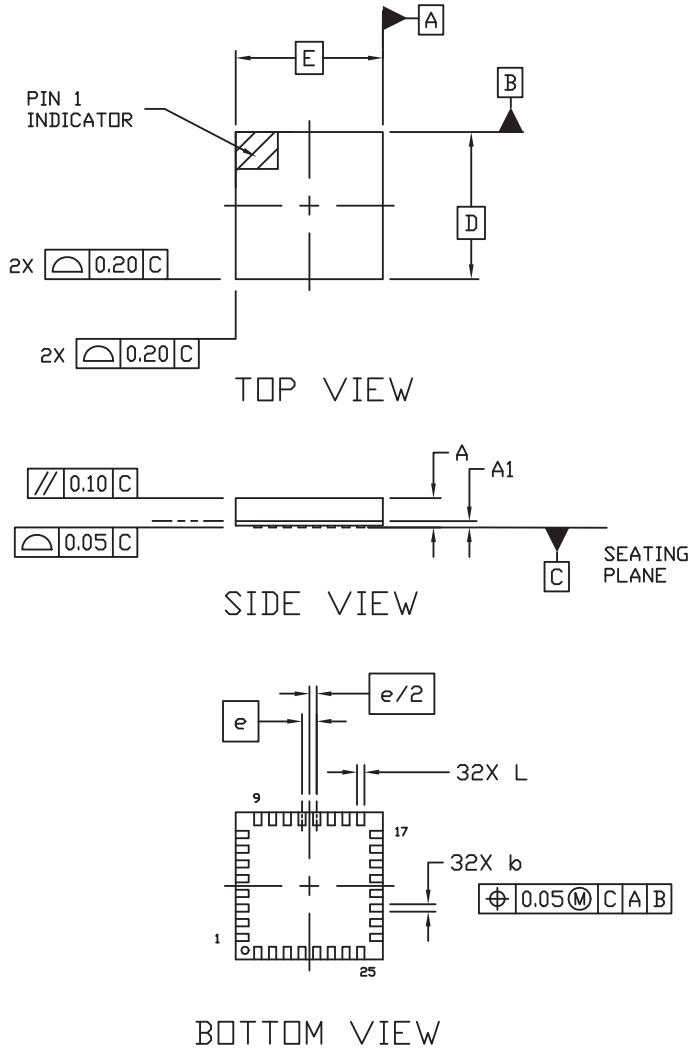

### NOTES:

1. DIMENSIONING AND TOLERANCING PER. ASME Y14.5M, 1994.
2. CONTROLLING DIMENSION: MILLIMETERS

DIM	MILLIMETERS	
	MIN.	MAX.
A	---	0.85
A1	---	0.05
b	0.15	0.25
D	4.00 BSC	
E	4.00 BSC	
e	0.40 BSC	
L	0.30	0.40

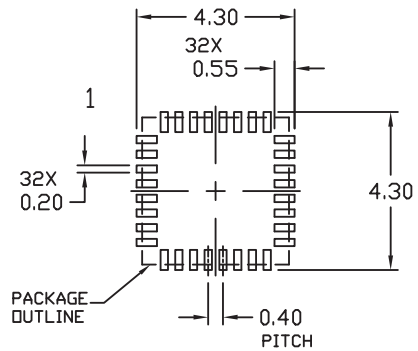

RECOMMENDED MOUNTING FOOTPRINT

### GENERIC MARKING DIAGRAM\*

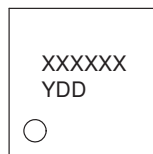
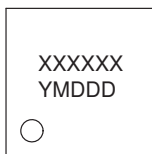

XXXXXX = Specific Device Code  
Y = Year  
M = Month  
DDD = Additional Traceability Data

XXXXXX = Specific Device Code  
Y = Year  
DD = Additional Traceability Data

\*This information is generic. Please refer to device data sheet for actual part marking. Pb-Free indicator, "G" or microdot "•", may or may not be present.

# LC87FBH08A

## Pin Assignment

LQFP36 7x7 / QFP36

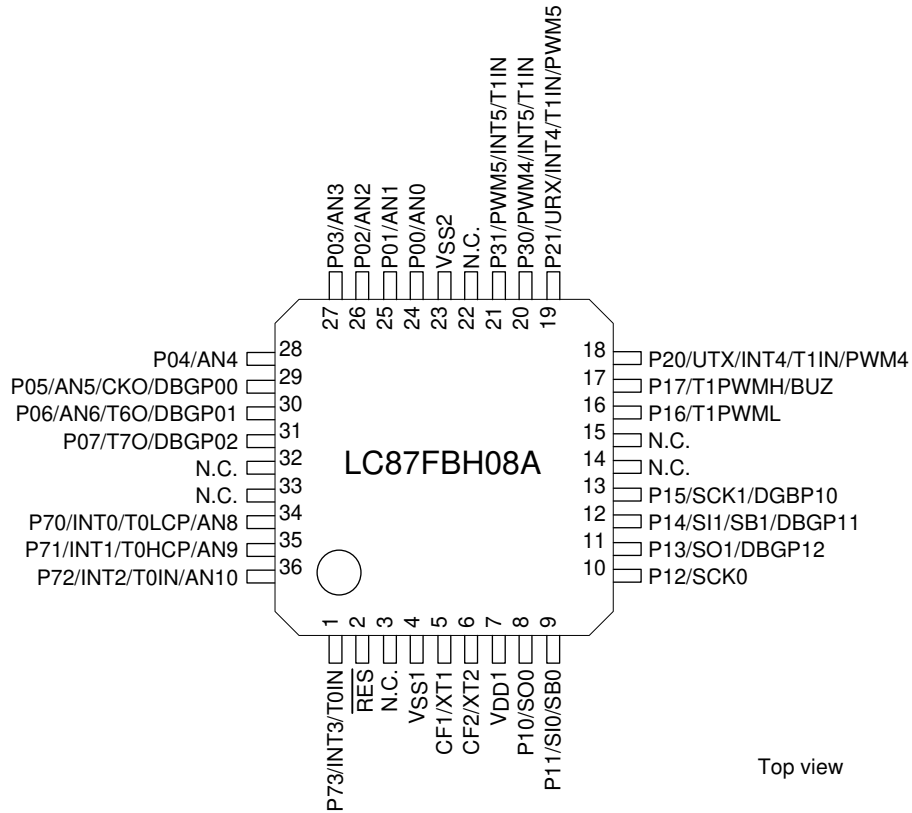

QFP36	NAME
1	P73/INT3/T0IN
2	RES
3	N.C.
4	V <sub>SS1</sub>
5	CF1/XT1
6	CF2/XT2
7	V <sub>DD1</sub>
8	P10/SO0
9	P11/SI0/SB0
10	P12/SCK0
11	P13/SO1/DBGP12
12	P14/SI1/SB1/DBGP11
13	P15/SCK1/DBGP10
14	N.C.
15	N.C.
16	P16/T1PWML
17	P17/T1PWMH/BUZ
18	P20/UTX/INT4/T1IN/PWM4

QFP36	NAME
19	P21/URX/INT4/T1IN/PWM5
20	P30/PWM4/INT5/T1IN
21	P31/PWM5/INT5/T1IN
22	N.C.
23	V <sub>SS2</sub>
24	P00/AN0
25	P01/AN1
26	P02/AN2
27	P03/AN3
28	P04/AN4
29	P05/AN5/CKO/DBGP00
30	P06/AN6/T6O/DBGP01
31	P07/T7O/DBGP02
32	N.C.
33	N.C.
34	P70/INT0/T0LCP/AN8
35	P71/INT1/T0HCP/AN9
36	P72/INT2/T0IN/AN10

Note: N.C. pins must be held open (disconnected).

# LC87FBH08A

## Pin Assignment

VQLP32 4x4 [Built to order]

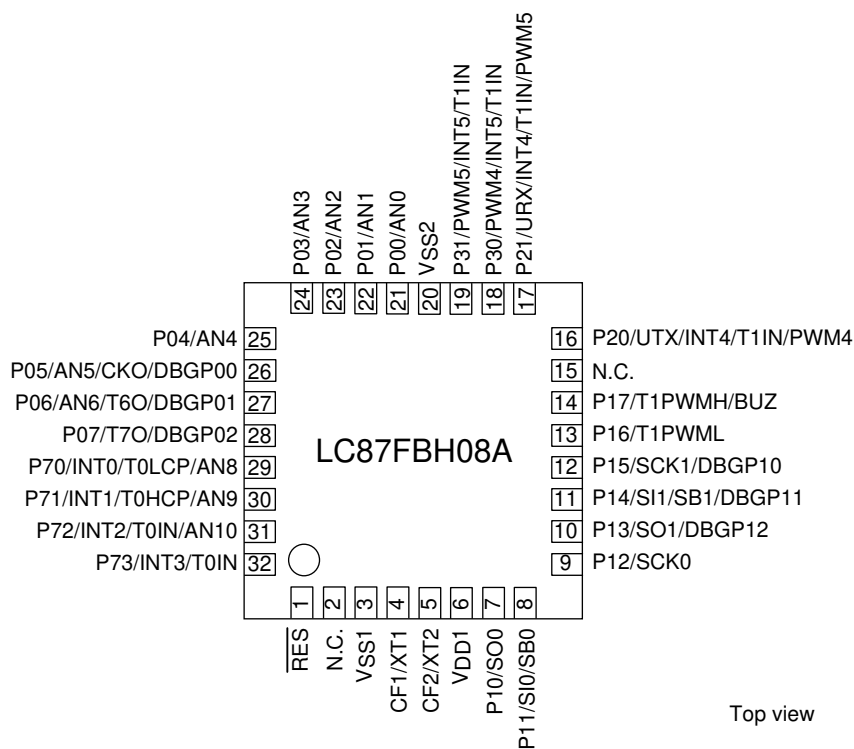

VQLP32	NAME
1	$\overline{\text{RES}}$
2	N.C.
3	V <sub>SS1</sub>
4	CF1/XT1
5	CF2/XT2
6	V <sub>DD1</sub>
7	P10/SO0
8	P11/SI0/SB0
9	P12/SCK0
10	P13/SO1/DBGP12
11	P14/SI1/SB1/DBGP11
12	P15/SCK1/DBGP10
13	P16/T1PWML
14	P17/T1PWMH/BUZ
15	N.C.
16	P20/UTX/INT4/T1IN/PWM4

VQLP32	NAME
17	P21/URX/INT4/T1IN/PWM5
18	P30/PWM4/INT5/T1IN
19	P31/PWM5/INT5/T1IN
20	V <sub>SS2</sub>
21	P00/AN0
22	P01/AN1
23	P02/AN2
24	P03/AN3
25	P04/AN4
26	P05/AN5/CKO/DBGP00
27	P06/AN6/T6O/DBGP01
28	P07/T7O/DBGP02
29	P70/INT0/T0LCP/AN8
30	P71/INT1/T0HCP/AN9
31	P72/INT2/T0IN/AN10
32	P73/INT3/T0IN

Note: N.C. pins must be held open (disconnected).

System Block Diagram

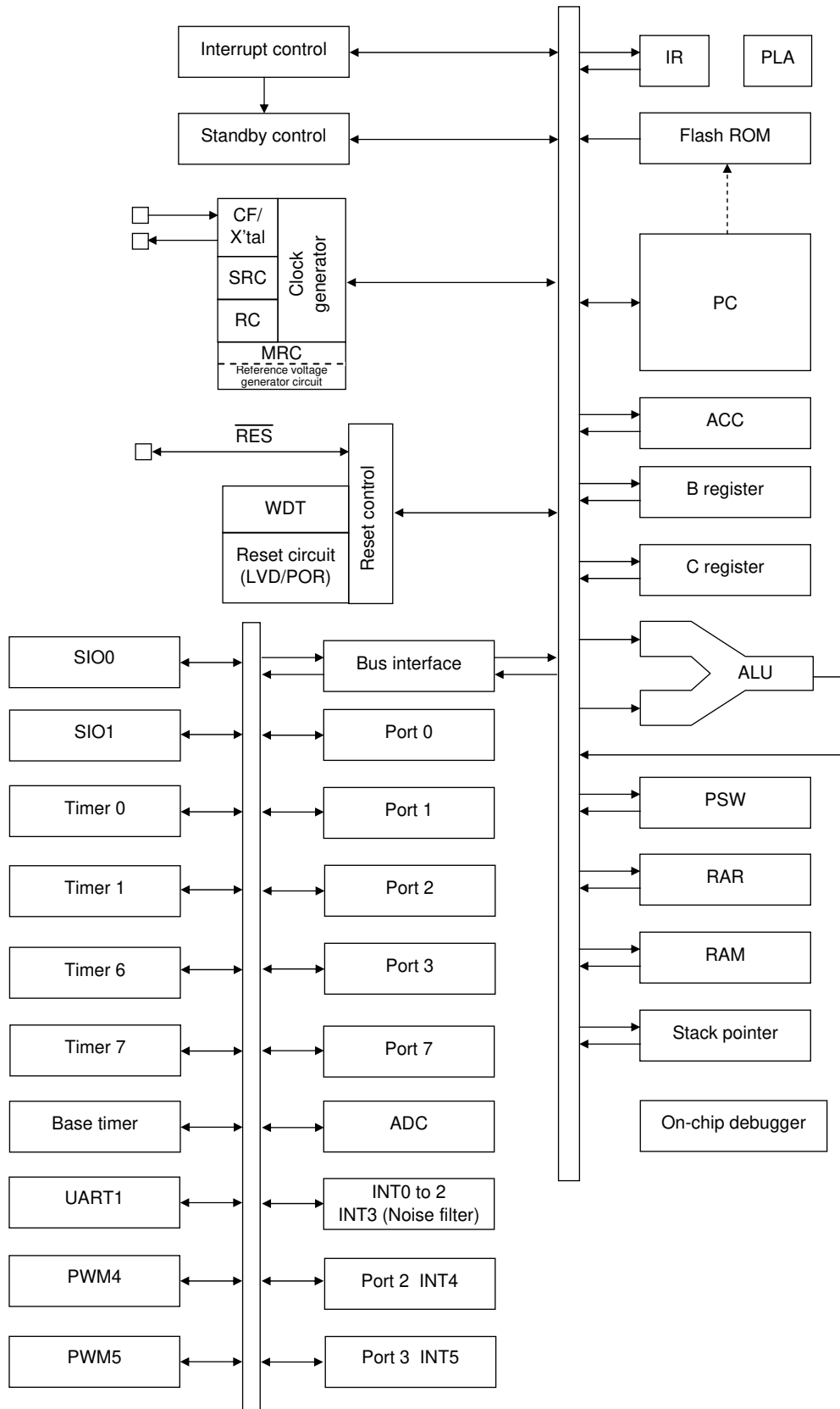

# LC87FBH08A

## Pin Function Chart

Pin Name	I/O	Description	Option												
V <sub>SS1</sub> , V <sub>SS2</sub>	-	- Power supply pin	No												
V <sub>DD1</sub>	-	+ Power supply pin	No												
Port 0 P00 to P07	I/O	<ul style="list-style-type: none"> <li>• 8-bit I/O port</li> <li>• I/O specifiable in 4-bit units</li> <li>• Pull-up resistors can be turned on and off in 4-bit units.</li> <li>• HOLD reset input</li> <li>• Port 0 interrupt input</li> <li>• Pin functions                             <ul style="list-style-type: none"> <li>P05: System clock output</li> <li>P06: Timer 6 toggle output</li> <li>P07: Timer 7 toggle output</li> <li>P00(AN0) to P06(AN6): AD converter input</li> <li>P05(DBGP00) to P07(DBGP02): On-chip debugger 0 port</li> </ul> </li> </ul>	Yes												
Port 1 P10 to P17	I/O	<ul style="list-style-type: none"> <li>• 8-bit I/O port</li> <li>• I/O specifiable in 1-bit units</li> <li>• Pull-up resistors can be turned on and off in 1-bit units.</li> <li>• Pin functions                             <ul style="list-style-type: none"> <li>P10: SIO0 data output</li> <li>P11: SIO0 data input/bus I/O</li> <li>P12: SIO0 clock I/O</li> <li>P13: SIO1 data output</li> <li>P14: SIO1 data input / bus I/O</li> <li>P15: SIO1 clock I/O</li> <li>P16: Timer 1PWML output</li> <li>P17: Timer 1PWMLH output / beeper output</li> <li>P15(DBGP10) to P13(DBGP12): On-chip-debugger 1 port</li> </ul> </li> </ul>	Yes												
Port 2 P20 to P21	I/O	<ul style="list-style-type: none"> <li>• 2-bit I/O port</li> <li>• I/O specifiable in 1-bit units</li> <li>• Pull-up resistors can be turned on and off in 1-bit units.</li> <li>• Pin functions                             <ul style="list-style-type: none"> <li>P20: UART transmit / PWM4 output</li> <li>P21: UART receive / PWM5 output</li> <li>P20 to P21: INT4 input / HOLD reset input / timer 1 event input / timer 0L capture input / timer 0H capture input</li> </ul> </li> </ul> <p>Interrupt acknowledge types</p> <table border="1" style="width: 100%; border-collapse: collapse; margin-left: 20px;"> <thead> <tr> <th style="width: 15%;"></th> <th style="width: 15%;">Rising</th> <th style="width: 15%;">Falling</th> <th style="width: 15%;">Rising &amp; Falling</th> <th style="width: 15%;">H level</th> <th style="width: 15%;">L level</th> </tr> </thead> <tbody> <tr> <td style="text-align: center;">INT4</td> <td style="text-align: center;">enable</td> <td style="text-align: center;">enable</td> <td style="text-align: center;">enable</td> <td style="text-align: center;">disable</td> <td style="text-align: center;">disable</td> </tr> </tbody> </table>		Rising	Falling	Rising & Falling	H level	L level	INT4	enable	enable	enable	disable	disable	Yes
	Rising	Falling	Rising & Falling	H level	L level										
INT4	enable	enable	enable	disable	disable										
Port 3 P30 to P31	I/O	<ul style="list-style-type: none"> <li>• 2-bit I/O port</li> <li>• I/O specifiable in 1 bit units</li> <li>• Pull-up resistors can be turned on and off in 1 bit units.</li> <li>• Pin functions                             <ul style="list-style-type: none"> <li>P30: PWM4 output</li> <li>P31: PWM5 output</li> <li>P30 to P31: INT5 input/HOLD reset input / timer 1 event input / timer 0L capture input / timer 0H capture input</li> </ul> </li> </ul> <p>Interrupt acknowledge types</p> <table border="1" style="width: 100%; border-collapse: collapse; margin-left: 20px;"> <thead> <tr> <th style="width: 15%;"></th> <th style="width: 15%;">Rising</th> <th style="width: 15%;">Falling</th> <th style="width: 15%;">Rising &amp; Falling</th> <th style="width: 15%;">H level</th> <th style="width: 15%;">L level</th> </tr> </thead> <tbody> <tr> <td style="text-align: center;">INT5</td> <td style="text-align: center;">enable</td> <td style="text-align: center;">enable</td> <td style="text-align: center;">enable</td> <td style="text-align: center;">disable</td> <td style="text-align: center;">disable</td> </tr> </tbody> </table>		Rising	Falling	Rising & Falling	H level	L level	INT5	enable	enable	enable	disable	disable	Yes
	Rising	Falling	Rising & Falling	H level	L level										
INT5	enable	enable	enable	disable	disable										

Continued on next page.

## LC87FBH08A

Continued from preceding page.

Pin Name	I/O	Description	Option																														
Port 7	I/O	<ul style="list-style-type: none"> <li>• 4-bit I/O port</li> <li>• I/O specifiable in 1 bit units</li> <li>• Pull-up resistors can be turned on and off in 1 bit units.</li> <li>• Pin functions                             <ul style="list-style-type: none"> <li>P70: INT0 input / HOLD reset input / timer 0L capture input</li> <li>P71: INT1 input / HOLD reset input / timer 0H capture input</li> <li>P72: INT2 input / HOLD reset input / timer 0 event input / timer 0L capture input</li> <li>P73: INT3 input (with noise filter) / timer 0 event input / timer 0H capture input</li> <li>P70(AN8) to P72(AN10): AD converter input</li> </ul> </li> <li>Interrupt acknowledge types                             <table border="1" style="margin-left: 20px; width: 100%; border-collapse: collapse;"> <thead> <tr> <th></th> <th>Rising</th> <th>Falling</th> <th>Rising &amp; Falling</th> <th>H level</th> <th>L level</th> </tr> </thead> <tbody> <tr> <td>INT0</td> <td>enable</td> <td>enable</td> <td>disable</td> <td>enable</td> <td>enable</td> </tr> <tr> <td>INT1</td> <td>enable</td> <td>enable</td> <td>disable</td> <td>enable</td> <td>enable</td> </tr> <tr> <td>INT2</td> <td>enable</td> <td>enable</td> <td>enable</td> <td>disable</td> <td>disable</td> </tr> <tr> <td>INT3</td> <td>enable</td> <td>enable</td> <td>enable</td> <td>disable</td> <td>disable</td> </tr> </tbody> </table> </li> </ul>		Rising	Falling	Rising & Falling	H level	L level	INT0	enable	enable	disable	enable	enable	INT1	enable	enable	disable	enable	enable	INT2	enable	enable	enable	disable	disable	INT3	enable	enable	enable	disable	disable	No
			Rising	Falling	Rising & Falling	H level	L level																										
INT0	enable	enable	disable	enable	enable																												
INT1	enable	enable	disable	enable	enable																												
INT2	enable	enable	enable	disable	disable																												
INT3	enable	enable	enable	disable	disable																												
P70 to P73																																	
$\overline{\text{RES}}$	I/O	External reset input / internal reset output	No																														
CF1/XT1	I	<ul style="list-style-type: none"> <li>• Ceramic resonator or 32.768kHz crystal oscillator input pin</li> <li>• Pin function                             <ul style="list-style-type: none"> <li>General-purpose input port</li> </ul> </li> </ul>	No																														
CF2/XT2	I/O	<ul style="list-style-type: none"> <li>• Ceramic resonator or 32.768kHz crystal oscillator output pin</li> <li>• Pin function                             <ul style="list-style-type: none"> <li>General-purpose I/O port</li> </ul> </li> </ul>	No																														

### Port Output Types

The table below lists the types of port outputs and the presence/absence of a pull-up resistor.

Data can be read into any input port even if it is in the output mode.

Port Name	Option selected in units of	Option type	Output type	Pull-up resistor
P00 to P07	1 bit	1	CMOS	Programmable (Note 1)
		2	Nch-open drain	No
P10 to P17	1 bit	1	CMOS	Programmable
		2	Nch-open drain	Programmable
P20 to P21	1 bit	1	CMOS	Programmable
		2	Nch-open drain	Programmable
P30 to P31	1 bit	1	CMOS	Programmable
		2	Nch-open drain	Programmable
P70	-	No	Nch-open drain	Programmable
P71 to P73	-	No	CMOS	Programmable
CF2/XT2	-	No	Ceramic resonator/32.768kHz crystal resonator output Nch-open drain (N-channel open drain when set to general-purpose output port)	No

Note 1: The control of the presence or absence of the programmable pull-up resistors for port 0 and the switching between low-and high-impedance pull-up connection is exercised in nibble (4-bit) units (P00 to 03 or P04 to 07).

### User Option Table

Option Name	Option to be Applied on	Mask version *1	Flash-ROM Version	Option Selected in Units of	Option Selection
Port output type	P00 to P07	○	○	1 bit	CMOS
					Nch-open drain
	P10 to P17	○	○	1 bit	CMOS
					Nch-open drain
	P20 to P21	○	○	1 bit	CMOS
					Nch-open drain
	P30 to P31	○	○	1 bit	CMOS
					Nch-open drain
Program start address	-	× *2	○	-	00000h
					01E00h
Low-voltage detection reset function	Detect function	○	○	-	Enable:Use
					Disable:Not Used
Power-on reset function	Power-On reset level	○	○	-	7-level
					8-level

\*1: Mask option selection - No change possible after mask is completed.

\*2: Program start address of the mask version is 00000h.

### Recommended Unused Pin Connections

Port Name	Recommended Unused Pin Connections	
	Board	Software
P00 to P07	Open	Output low
P10 to P17	Open	Output low
P20 to P21	Open	Output low
P30 to P31	Open	Output low
P70 to P73	Open	Output low
CF1/XT1	Pulled low with a 100kΩ resistor or less	General-purpose input port
CF2/XT2	Pulled low with a 100kΩ resistor or less	General-purpose input port

### On-chip Debugger Pin Connection Requirements

For the treatment of the on-chip debugger pins, refer to the separately available documents entitled "RD87 on-chip debugger installation manual".

### Power Pin Treatment Recommendations (VDD1, VSS1)

Connect bypass capacitors that meet the following conditions between the VDD1 and VSS1 pins:

- Connect among the VDD1 and VSS1 pins and bypass capacitors C1 and C2 with the shortest possible heavy lead wires, making sure that the impedances between the both pins and the bypass capacitors are as possible ( $L1=L1'$ ,  $L2=L2'$ ).
- Connect a large-capacity capacitor C1 and a small-capacity capacitor C2 in parallel. The capacitance of C2 should be approximately 0.1μF.

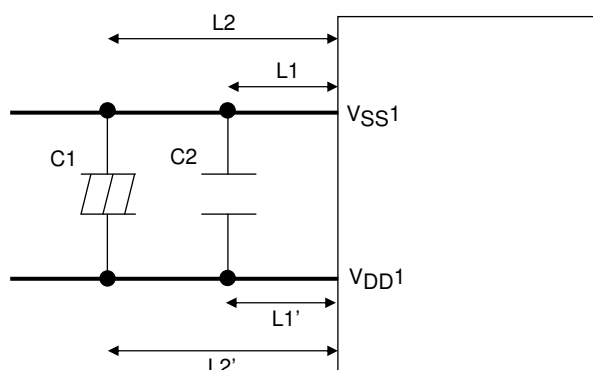

Note: Be sure to electrically short-circuit between the VSS1 and VSS2 pins.

# LC87FBH08A

**Absolute Maximum Ratings** at Ta = 25°C, VSS1 = VSS2 = 0V

Parameter	Symbol	Pin/Remarks	Conditions	Specification				unit
				VDD[V]	min	typ	max	
Maximum supply voltage	VDD max	VDD1			-0.3		+6.5	V
Input voltage	VI	CF1			-0.3		VDD+0.3	
Input/output voltage	VI/O	Ports 0, 1, 2, 3, Port 7, CF2, RES			-0.3		VDD+0.3	
High level output current	Peak output current	IOPH(1)	Ports 0, 1, 2, 3	CMOS output select Per 1 applicable pin		-10		mA
		IOPH(2)	P71 to P73	Per 1 applicable pin		-5		
	Mean output current (Note 1-1)	IOMH(1)	Ports 0, 1, 2, 3	CMOS output select Per 1 applicable pin		-7.5		
		IOMH(2)	P71 to P73	Per 1 applicable pin		-3		
Total output current	ΣIOAH(1)	Ports 0, 1, 2, 3, P71 to P73	Total of all applicable pins		-25			
Low level output current	Peak output current	IOPL(1)	P02 to P07, Ports 1, 2, 3	Per 1 applicable pin			20	
		IOPL(2)	P00, P01	Per 1 applicable pin			30	
		IOPL(3)	Port 7, CF2	Per 1 applicable pin			10	
	Mean output current (Note 1-1)	IOML(1)	P02 to P07 Ports 1, 2, 3	Per 1 applicable pin				15
		IOML(2)	P00, P01	Per 1 applicable pin				20
		IOML(3)	Port 7, CF2	Per 1 applicable pin				7.5
	Total output current	ΣIOAL(1)	Ports 0, 1, Ports 2, 3, CF2	Total of all applicable pins				70
ΣIOAL(2)		Port 7	Total of all applicable pins				15	
Power dissipation	Pd max(1)	QFP36(7×7)	Ta=-40 to +85°C Package only				120	mW
	Pd max(2)		Ta=-40 to +85°C Package with thermal resistance board (Note 1-2)				275	
Operating ambient temperature	Topr				-40		+85	°C
Storage ambient temperature	Tstg				-55		+125	

Note 1-1: The mean output current is a mean value measured over 100ms.

Note 1-2: SEMI standards thermal resistance board (size: 76.1×114.3×1.6mm, glass epoxy) is used.

Stresses exceeding those listed in the Maximum Ratings table may damage the device. If any of these limits are exceeded, device functionality should not be assumed, damage may occur and reliability may be affected.



# LC87FBH08A

**Allowable Operating Conditions** at Ta = -40°C to +85°C, VSS1 = VSS2 = 0V

Parameter	Symbol	Pin/Remarks	Conditions	Specification				unit
				VDD[V]	min	typ	max	
Operating supply voltage (Note 2-1)	VDD(1)	VDD1	0.245μs ≤ tCYC ≤ 200μs		2.7		5.5	V
	VDD(2)		0.294μs ≤ tCYC ≤ 200μs		2.2		5.5	
	VDD(3)		0.735μs ≤ tCYC ≤ 200μs		1.8		5.5	
Memory sustaining supply voltage	VHD	VDD1	RAM and register contents sustained in HOLD mode.		1.6			
High level input voltage	VIH(1)	Ports 1, 2, 3, 7		1.8 to 5.5	0.3VDD+0.7		VDD	
	VIH(2)	Ports 0		1.8 to 5.5	0.3VDD+0.7		VDD	
	VIH(3)	CF1, CF2, RES		1.8 to 5.5	0.75VDD		VDD	
Low level input voltage	VIL(1)	Ports 1, 2, 3, 7		4.0 to 5.5	VSS		0.1VDD+0.4	
				1.8 to 4.0	VSS		0.2VDD	
	VIL(2)	Ports 0		4.0 to 5.5	VSS		0.15VDD+0.4	
				1.8 to 4.0	VSS		0.2VDD	
VIL(3)	CF1, CF2, RES		1.8 to 5.5	VSS		0.25VDD		
High level output current	IOH(1)	Ports 0, 1, 2, P71 to P73	Per 1 applicable pin	4.5 to 5.5	-1.0			
	IOH(2)			2.7 to 4.5	-0.35			
	IOH(3)			1.8 to 2.7	-0.15			
	IOH(4)	Ports 3, P05 (System clock output function used)	Per 1 applicable pin	4.5 to 5.5	-6.0			
	IOH(5)			2.7 to 4.5	-1.4			
	IOH(6)			1.8 to 2.7	-0.8			
	ΣIOH(1)	Ports 0, 1, 2, 3, 7	Total of all applicable pins	4.5 to 5.5	-25			
	ΣIOH(2)			2.7 to 4.5	-11.2			
ΣIOH(3)	1.8 to 2.7			-5.4				
Low level output current	IOL(1)	Ports 0, 1, 2, 3	Per 1 applicable pin	4.5 to 5.5			10	
	IOL(2)			2.7 to 4.5			1.4	
	IOL(3)			1.8 to 2.7			0.8	
	IOL(4)	Port 7, CF2	Per 1 applicable pin	2.7 to 5.5			1.4	
	IOL(5)			1.8 to 2.7			0.8	
	IOL(6)	P00, P01	Per 1 applicable pin	4.5 to 5.5			25	
	IOL(7)			2.7 to 4.5			4	
	IOL(8)			1.8 to 2.7			2	
	ΣIOL(1)	Ports 0, 1, 2, 3, CF2	Total of all applicable pins	4.5 to 5.5			70	
	ΣIOL(2)			2.7 to 4.5			34.6	
	ΣIOL(3)			1.8 to 2.7			19.2	
	ΣIOL(4)	Ports 7	Total of all applicable pins	2.7 to 5.5			5.6	
ΣIOL(5)	1.8 to 2.7					3.2		
Instruction cycle time (Note 2-2)	tCYC			2.7 to 5.5	0.245		200	
				2.2 to 5.5	0.294		200	
				1.8 to 5.5	0.735		200	
External system clock frequency	FEXCF	CF1	<ul style="list-style-type: none"> <li>• CF2 pin open</li> <li>• System clock frequency division ratio=1/1</li> <li>• External system clock duty=50±5%</li> </ul>	2.7 to 5.5	0.1		12	
				1.8 to 5.5	0.1		4	
				3.0 to 5.5	0.2		24.4	
				2.0 to 5.5	0.2		8	

Note 2-1: VDD must be held greater than or equal to 2.2V in the flash ROM onboard programming mode.

Note 2-2: Relationship between tCYC and oscillation frequency is 3/FmCF at a division ratio of 1/1 and 6/FmCF at a division ratio of 1/2.

Continued on next page.

# LC87FBH08A

Continued from preceding page.

Parameter	Symbol	Pin/Remarks	Conditions	Specification				
				V <sub>DD</sub> [V]	min	typ	max	unit
Oscillation frequency range (Note 2-3)	FmCF(1)	CF1, CF2	12MHz ceramic oscillation. See Fig. 1.	2.7 to 5.5		12		MHz
	FmCF(2)	CF1, CF2	10MHz ceramic oscillation. See Fig. 1.	2.2 to 5.5		10		
	FmCF(3)	CF1, CF2	4MHz ceramic oscillation. CF oscillation normal amplifier size selected. (CFLAMP=0) See Fig. 1.	1.8 to 5.5		4		
			4MHz ceramic oscillation. CF oscillation low amplifier size selected. (CFLAMP=1) See Fig. 1.	2.2 to 5.5		4		
	FmMRC(1)		Frequency variable RC oscillation. (Note 2-4)	1.8 to 5.5	7.84	8.0	8.16	
	FmMRC(2)		Frequency variable RC oscillation. • Ta=-10 to +85°C (Note 2-4)	1.8 to 5.5	7.88	8.0	8.12	
	FmRC		Internal medium-speed RC oscillation	1.8 to 5.5	0.5	1.0	2.0	
	FmSRC		Internal low-speed RC oscillation	1.8 to 5.5	50	100	200	
	FsX'tal	XT1, XT2	32.768kHz crystal oscillation See Fig. 1.	1.8 to 5.5		32.768		kHz
Oscillation stabilization time	tmsMRC		When Frequency variable RC oscillation state is switched from stopped to enabled. See Fig. 3.	1.8 to 5.5			100	μs

Note 2-3: See Tables 1 and 2 for the oscillation constants.

Note 2-4: When switching the system clock, allow an oscillation stabilization time of 100μs or longer after the frequency variable RC oscillator circuit transmits from the "oscillation stopped" to "oscillation enabled" state.

Functional operation above the stresses listed in the Recommended Operating Ranges is not implied. Extended exposure to stresses beyond the Recommended Operating Ranges limits may affect device reliability.

# LC87FBH08A

## Electrical Characteristics at Ta = -40°C to +85°C, VSS1 = VSS2 = 0V

Parameter	Symbol	Pin/Remarks	Conditions	Specification				
				VDD[V]	min	typ	max	unit
High level input current	I <sub>IH</sub> (1)	Ports 0, 1, 2, 3, Ports 7, $\overline{\text{RES}}$	Output disabled Pull-up resistor off V <sub>IN</sub> =V <sub>DD</sub> (Including output Tr's off leakage current)	1.8 to 5.5			1	μA
	I <sub>IH</sub> (2)	CF1, CF2	Input port selected V <sub>IN</sub> =V <sub>DD</sub>	1.8 to 5.5			1	
	I <sub>IH</sub> (3)	CF1	Reset state V <sub>IN</sub> =V <sub>DD</sub>	1.8 to 5.5			15	
Low level input current	I <sub>IL</sub> (1)	Ports 0, 1, 2, 3, Ports 7, $\overline{\text{RES}}$	Output disabled Pull-up resistor off V <sub>IN</sub> =V <sub>SS</sub> (Including output Tr's off leakage current)	1.8 to 5.5	-1			
	I <sub>IL</sub> (2)	CF1, CF2	Input port selected V <sub>IN</sub> =V <sub>SS</sub>	1.8 to 5.5	-1			
High level output voltage	V <sub>OH</sub> (1)	Ports 0, 1, 2 P71 to P73	I <sub>OH</sub> =-1mA	4.5 to 5.5	V <sub>DD</sub> -1			V
	V <sub>OH</sub> (2)		I <sub>OH</sub> =-0.35mA	2.7 to 5.5	V <sub>DD</sub> -0.4			
	V <sub>OH</sub> (3)		I <sub>OH</sub> =-0.15mA	1.8 to 5.5	V <sub>DD</sub> -0.4			
	V <sub>OH</sub> (4)	Ports 3 P05 (System clock output function used)	I <sub>OH</sub> =-6mA	4.5 to 5.5	V <sub>DD</sub> -1			
	V <sub>OH</sub> (5)		I <sub>OH</sub> =-1.4mA	2.7 to 5.5	V <sub>DD</sub> -0.4			
	V <sub>OH</sub> (6)		I <sub>OH</sub> =-0.8mA	1.8 to 5.5	V <sub>DD</sub> -0.4			
Low level output voltage	V <sub>OL</sub> (1)	Ports 0, 1, 2, 3	I <sub>OL</sub> =10mA	4.5 to 5.5			1.5	V
	V <sub>OL</sub> (2)		I <sub>OL</sub> =1.4mA	2.7 to 5.5			0.4	
	V <sub>OL</sub> (3)		I <sub>OL</sub> =0.8mA	1.8 to 5.5			0.4	
	V <sub>OL</sub> (4)	Port 7, CF2	I <sub>OL</sub> =1.4mA	2.7 to 5.5			0.4	
	V <sub>OL</sub> (5)		I <sub>OL</sub> =0.8mA	1.8 to 5.5			0.4	
	V <sub>OL</sub> (6)	P00, P01	I <sub>OL</sub> =25mA	4.5 to 5.5			1.5	
	V <sub>OL</sub> (7)		I <sub>OL</sub> =4mA	2.7 to 5.5			0.4	
	V <sub>OL</sub> (8)		I <sub>OL</sub> =2mA	1.8 to 5.5			0.4	
Pull-up resistance	R <sub>pu</sub> (1)	Ports 0, 1, 2, 3, Ports 7	V <sub>OH</sub> =0.9V <sub>DD</sub> When Port 0 selected low-impedance pull-up.	4.5 to 5.5	15	35	80	kΩ
	R <sub>pu</sub> (2)		V <sub>OH</sub> =0.9V <sub>DD</sub> When Port 0 selected high-impedance pull-up.	1.8 to 4.5	18	50	230	
	R <sub>pu</sub> (3)	Port 0	V <sub>OH</sub> =0.9V <sub>DD</sub> When Port 0 selected high-impedance pull-up.	1.8 to 5.5	100	200	400	
Hysteresis voltage	V <sub>HYS</sub> (1)	Ports 1, 2, 3, Ports 7, $\overline{\text{RES}}$		2.7 to 5.5		0.1V <sub>DD</sub>		V
	V <sub>HYS</sub> (2)			1.8 to 2.7		0.07V <sub>DD</sub>		
Pin capacitance	CP	All pins	For pins other than that under test: V <sub>IN</sub> =V <sub>SS</sub> f=1MHz Ta=25°C	1.8 to 5.5		10		pF

Product parametric performance is indicated in the Electrical Characteristics for the listed test conditions, unless otherwise noted. Product performance may not be indicated by the Electrical Characteristics if operated under different conditions.

# LC87FBH08A

## SIO0 Serial I/O Characteristics at Ta = -40°C to +85°C, VSS1 = VSS2 = 0V (Note 4-1-1)

Parameter		Symbol	Pin/ Remarks	Conditions	VDD[V]	Specification			unit	
						min	typ	max		
Serial clock	Input clock	Frequency	tSCK(1)	SCK0(P12)	• See Fig. 5.	1.8 to 5.5	2			tCYC
		Low level pulse width	tSCKL(1)				1			
		High level pulse width	tSCKH(1)				1			
			tSCKHA(1)							
					• Continuous data transmission/reception mode • See Fig. 5. (Note 4-1-2)	1.8 to 5.5	4			
Serial clock	Output clock	Frequency	tSCK(2)	SCK0(P12)	• CMOS output selected • See Fig. 5.	1.8 to 5.5	4/3			tSCK
		Low level pulse width	tSCKL(2)				1/2			
		High level pulse width	tSCKH(2)				1/2			
			tSCKHA(2)							
				• Continuous data transmission/reception mode • CMOS output selected • See Fig. 5.	1.8 to 5.5	tSCKH(2) +2tCYC		tSCKH(2) +(10/3) tCYC	tCYC	
Serial input	Data setup time	tsDI(1)	SB0(P11), SIO(P11)	• Must be specified with respect to rising edge of SIOCLK. • See Fig. 5.	1.8 to 5.5	0.05				
	Data hold time	thDI(1)				0.05				
Serial output	Input clock	Output delay time	tdD0(1)	SO0(P10), SB0(P11)	• Continuous data transmission/reception mode (Note 4-1-3)  • Synchronous 8-bit mode (Note 4-1-3)  (Note 4-1-3)	1.8 to 5.5			(1/3)tCYC +0.08	μs
			tdD0(2)						1tCYC +0.08	
	tdD0(3)						(1/3)tCYC +0.08			

Note 4-1-1: These specifications are theoretical values. Add margin depending on its use.

Note 4-1-2: To use serial-clock-input in continuous trans/rec mode, a time from SIORUN being set when serial clock is "H" to the first negative edge of the serial clock must be longer than tSCKHA.

Note 4-1-3: Must be specified with respect to falling edge of SIOCLK. Must be specified as the time to the beginning of output state change in open drain output mode. See Fig. 5.

# LC87FBH08A

## SI01 Serial I/O Characteristics at Ta = -40°C to +85°C, VSS1 = VSS2 = 0V (Note 4-2-1)

Parameter		Symbol	Pin/ Remarks	Conditions	VDD[V]	Specification				
						min	typ	max	unit	
Serial clock	Input clock	Frequency	tSCK(3)	SCK1(P15)	• See Fig. 5.	1.8 to 5.5	2			tCYC
		Low level pulse width	tSCKL(3)				1			
		High level pulse width	tSCKH(3)				1			
	Output clock	Frequency	tSCK(4)	SCK1(P15)	• CMOS output selected • See Fig. 5.	1.8 to 5.5	2			tSCK
		Low level pulse width	tSCKL(4)				1/2			
		High level pulse width	tSCKH(4)				1/2			
Serial input	Data setup time	tsDI(2)	SI1(P14), SB1(P14)	• Must be specified with respect to rising edge of SIOCLK. • See Fig. 5.	1.8 to 5.5	(1/3)tCYC +0.01			μs	
	Data hold time	thDI(2)				0.01				
Serial output	Output delay time	tdD0(4)	SO1(P13), SB1(P14)	• Must be specified with respect to falling edge of SIOCLK. • Must be specified as the time to the beginning of output state change in open drain output mode. • See Fig. 5.	1.8 to 5.5			(1/2)tCYC +0.05	μs	

Note 4-2-1: These specifications are theoretical values. Add margin depending on its use.

## Pulse Input Conditions at Ta = -40°C to +85°C, VSS1 = VSS2 = 0V

Parameter	Symbol	Pin/Remarks	Conditions	VDD[V]	Specification			
					min	typ	max	unit
High/low level pulse width	tPIH(1) tPIL(1)	INT0(P70), INT1(P71), INT2(P72), INT4(P20 to P21) INT5(P30 to P31)	• Interrupt source flag can be set. • Event inputs for timer 0 or 1 are enabled.	1.8 to 5.5	1			tCYC
	tPIH(2) tPIL(2)	INT3(P73) when noise filter time constant is 1/1	• Interrupt source flag can be set. • Event inputs for timer 0 are enabled.	1.8 to 5.5	2			
	tPIH(3) tPIL(3)	INT3(P73) when noise filter time constant is 1/32	• Interrupt source flag can be set. • Event inputs for timer 0 are enabled.	1.8 to 5.5	64			
	tPIH(4) tPIL(4)	INT3(P73) when noise filter time constant is 1/128	• Interrupt source flag can be set. • Event inputs for timer 0 are enabled.	1.8 to 5.5	256			
	tPIL(5)	RES		• Resetting is enabled.	1.8 to 5.5	200		

## LC87FBH08A

### AD Converter Characteristics at $V_{SS1} = V_{SS2} = 0V$

<12bits AD Converter Mode at  $T_a = -40^{\circ}C$  to  $+85^{\circ}C$  >

Parameter	Symbol	Pin/Remarks	Conditions	Specification				
				$V_{DD}[V]$	min	typ	max	unit
Resolution	N	AN0(P00) to AN6(P06), AN8(P70) to AN10(P72)		1.8 to 5.5		12		bit
Absolute accuracy	ET		(Note 6-1)	2.7 to 5.5			$\pm 16$	LSB
				1.8 to 5.5			$\pm 20$	
Conversion time	TCAD		• See Conversion time calculation formulas. (Note 6-2)	2.7 to 5.5	32		115	$\mu s$
				2.2 to 5.5	134		215	
				1.8 to 5.5	400		430	
Analog input voltage range	VAIN			1.8 to 5.5	$V_{SS}$		$V_{DD}$	V
Analog port input current	IAINH	$VAIN = V_{DD}$	1.8 to 5.5			1	$\mu A$	
	IAINL	$VAIN = V_{SS}$	1.8 to 5.5	-1				

<8bits AD Converter Mode at  $T_a = -40^{\circ}C$  to  $+85^{\circ}C$  >

Parameter	Symbol	Pin/Remarks	Conditions	Specification				
				$V_{DD}[V]$	min	typ	max	unit
Resolution	N	AN0(P00) to AN6(P06), AN8(P70) to AN10(P72)		1.8 to 5.5		8		bit
Absolute accuracy	ET		(Note 6-1)	1.8 to 5.5			$\pm 1.5$	LSB
Conversion time	TCAD		• See Conversion time calculation formulas. (Note 6-2)	2.7 to 5.5	20		90	$\mu s$
				2.2 to 5.5	80		135	
				1.8 to 5.5	245		265	
Analog input voltage range	VAIN			1.8 to 5.5	$V_{SS}$		$V_{DD}$	V
Analog port input current	IAINH	$VAIN = V_{DD}$	1.8 to 5.5			1	$\mu A$	
	IAINL	$VAIN = V_{SS}$	1.8 to 5.5	-1				

Note 6-1: The quantization error ( $\pm 1/2LSB$ ) must be excluded from the absolute accuracy. The absolute accuracy must be measured in the microcontroller's state in which no I/O operations occur at the pins adjacent to the analog input channel.

Note 6-2: The conversion time refers to the period from the time an instruction for starting a conversion process till the time the conversion results register(s) are loaded with a complete digital conversion value corresponding to the analog input value.

The conversion time is 2 times the normal-time conversion time when:

- The first AD conversion is performed in the 12-bit AD conversion mode after a system reset.
- The first AD conversion is performed after the AD conversion mode is switched from 8-bit to 12-bit conversion mode.

Conversion time calculation formulas:

$$12\text{bits AD Converter Mode: } TCAD(\text{Conversion time}) = ((52/(\text{AD division ratio}))+2) \times (1/3) \times tCYC$$

$$8\text{bits AD Converter Mode: } TCAD(\text{Conversion time}) = ((32/(\text{AD division ratio}))+2) \times (1/3) \times tCYC$$

External oscillation (FmCF)	Operating supply voltage range ( $V_{DD}$ )	System division ratio (SYSDIV)	Cycle time (tCYC)	AD division ratio (ADDIV)	AD conversion time (TCAD)	
					12bit AD	8bit AD
CF-12MHz	2.7V to 5.5V	1/1	250ns	1/8	34.8 $\mu s$	21.5 $\mu s$
CF-8MHz	2.7V to 5.5V	1/1	375ns	1/8	52.25 $\mu s$	32.25 $\mu s$
	2.2V to 5.5V	1/1	375ns	1/32	208.25 $\mu s$	128.25 $\mu s$
CF-4MHz	2.7V to 5.5V	1/1	750ns	1/8	104.5 $\mu s$	64.5 $\mu s$
	2.2V to 5.5V	1/1	750ns	1/16	208.5 $\mu s$	128.5 $\mu s$
	1.8V to 5.5V	1/1	750ns	1/32	416.5 $\mu s$	256.5 $\mu s$

## LC87FBH08A

### Reference voltage (VREF17) Characteristics at Ta = -40°C to +85°C, VSS1 = VSS2 = 0V

Parameter	Symbol	Pin/Remarks	Conditions	Specification				
				V <sub>DD</sub> [V]	min	typ	max	unit
Output voltage	VOVREF			2.0 to 5.5	1.67	1.75	1.83	V
Reference voltage operation current (Note 7-1)	IDDVREF			2.0 to 5.5		110		μA
Operation stabilization time (Note 7-2)	tVRW			2.0 to 5.5			100	μs

Note 7-1: IDDVREF denotes the currents that only flow to multivariable RC oscillator circuit's reference voltage circuit.

Note 7-2: tVRW denotes the stabilization time from starting multivariable RC oscillator.

### Power-on Reset (POR) Characteristics at Ta = -40°C to +85°C, VSS1 = VSS2 = 0V

Parameter	Symbol	Pin/Remarks	Conditions	Specification				
				Option selected voltage	min	typ	max	unit
POR release voltage	PORRL		<ul style="list-style-type: none"> <li>Select from option. (Note 8-1)</li> </ul>	1.67V	1.55	1.66	1.77	V
				1.97V	1.85	1.96	2.07	
				2.07V	1.93	2.05	2.17	
				2.37V	2.23	2.35	2.47	
				2.57V	2.43	2.55	2.67	
				2.87V	2.71	2.85	2.99	
				3.86V	3.65	3.83	4.00	
				4.35V	4.12	4.32	4.50	
Detection voltage unknown state	POUKS		<ul style="list-style-type: none"> <li>See Fig. 7. (Note 8-2)</li> </ul>			0.7	0.95	
Power supply rise time	PORIS		<ul style="list-style-type: none"> <li>Power supply rise time from 0V to 1.6V.</li> </ul>				100	ms

Note8-1: The POR release level can be selected out of 8 levels only when the LVD reset function is disabled.

Note8-2: POR is in an unknown state before transistors start operation.

### Low Voltage Detection Reset (LVD) Characteristics at Ta = -40°C to +85°C, VSS1 = VSS2 = 0V

Parameter	Symbol	Pin/Remarks	Conditions	Specification				
				Option selected voltage	min	typ	max	unit
LVD reset voltage (Note 9-2)	LVDET		<ul style="list-style-type: none"> <li>Select from option. (Note 9-1) (Note 9-3)</li> <li>See Fig. 8.</li> </ul>	1.91V	1.81	1.91	2.01	V
				2.01V	1.90	2.00	2.10	
				2.31V	2.20	2.30	2.40	
				2.51V	2.40	2.50	2.60	
				2.81V	2.68	2.80	2.92	
				3.79V	3.62	3.78	3.94	
				4.28V	4.09	4.27	4.45	
LVD hysteresis width	LVHYS			1.91V		50		mV
				2.01V		50		
				2.31V		50		
				2.51V		50		
				2.81V		50		
				3.79V		50		
Detection voltage unknown state	LVUKS		<ul style="list-style-type: none"> <li>See Fig. 8. (Note 9-4)</li> </ul>			0.7	0.95	V
Low voltage detection minimum width (Reply sensitivity)	TLVDW		<ul style="list-style-type: none"> <li>LVDET-0.5V</li> <li>See Fig. 9.</li> </ul>		0.2			ms

Note9-1: The LVD reset level can be selected out of 7 levels only when the LVD reset function is enabled.

Note9-2: LVD reset voltage specification values do not include hysteresis voltage.

Note9-3: LVD reset voltage may exceed its specification values when port output state changes and/or when a large current flows through port.

Note9-4: LVD is in an unknown state before transistors start operation.

# LC87FBH08A

**Consumption Current Characteristics** at Ta = -40°C to +85°C, V<sub>SS1</sub> = V<sub>SS2</sub> = 0V

Parameter	Symbol	Pin/ Remarks	Conditions	Specification				
				V <sub>DD</sub> [V]	min	typ	max	unit
Normal mode consumption current (Note 10-1) (Note 10-2)	IDDOP(1)	V <sub>DD1</sub>	<ul style="list-style-type: none"> <li>FmCF=12MHz ceramic oscillation mode</li> <li>System clock set to 12MHz side</li> <li>Internal low speed and medium speed RC oscillation stopped.</li> </ul>	2.7 to 5.5		5.1	9.3	mA
				2.7 to 3.6		3.1	5.6	
	IDDOP(2)		<ul style="list-style-type: none"> <li>CF1=24MHz external clock</li> <li>System clock set to CF1 side</li> <li>Internal low speed and medium speed RC oscillation stopped.</li> </ul>	3.0 to 5.5		5.2	10	
				3.0 to 3.6		3.3	6.2	
	IDDOP(3)		<ul style="list-style-type: none"> <li>FmCF=10MHz ceramic oscillation mode</li> <li>System clock set to 10MHz side</li> <li>Internal low speed and medium speed RC oscillation stopped.</li> </ul>	2.2 to 5.5		4.4	8.4	
				2.2 to 3.6		2.8	5.5	
	IDDOP(4)		<ul style="list-style-type: none"> <li>FmCF=4MHz ceramic oscillation mode</li> <li>System clock set to 4MHz side</li> <li>Internal low speed and medium speed RC oscillation stopped.</li> </ul>	1.8 to 5.5		2.3	5.3	
				1.8 to 3.6		1.6	3.0	
	IDDOP(5)		<ul style="list-style-type: none"> <li>CF oscillation low amplifier size selected. (CFLAMP=1)</li> <li>FmCF=4MHz ceramic oscillation mode</li> <li>System clock set to 4MHz side</li> </ul>	2.2 to 5.5		0.97	2.4	
				2.2 to 3.6		0.55	1.2	
	IDDOP(6)		<ul style="list-style-type: none"> <li>FsX'tal=32.768kHz crystal oscillation mode</li> <li>Internal low speed RC oscillation stopped.</li> </ul>	1.8 to 5.5		0.44	1.5	
				1.8 to 3.6		0.28	0.80	
	IDDOP(7)		<ul style="list-style-type: none"> <li>FsX'tal=32.768kHz crystal oscillation mode</li> <li>Internal low speed and medium speed RC oscillation stopped.</li> </ul>	1.8 to 5.5		3.4	5.5	
				1.8 to 3.6		2.4	4.6	
	IDDOP(8)		<ul style="list-style-type: none"> <li>External FsX'tal and FmCF oscillation stopped.</li> <li>System clock set to internal low speed RC oscillation.</li> </ul>	1.8 to 5.5		51	163	
				1.8 to 3.6		38	103	
IDDOP(9)	<ul style="list-style-type: none"> <li>External FsX'tal and FmCF oscillation stopped.</li> <li>System clock set to internal low speed RC oscillation.</li> </ul>	5.0		51	136			
		3.3		38	99			
		2.5		36	94			
			<ul style="list-style-type: none"> <li>Internal medium speed RC oscillation stopped.</li> <li>Frequency variable RC oscillation stopped.</li> <li>1/1 frequency division ratio</li> <li>Ta=-10 to +50°C</li> </ul>					μA

Note10-1: Values of the consumption current do not include current that flows into the output transistors and internal pull-up resistors.

Note10-2: The consumption current values do not include operational current of LVD function if not specified.

Continued on next page.



# LC87FBH08A

Continued from preceding page.

Parameter	Symbol	Pin/ Remarks	Conditions	Specification				
				V <sub>DD</sub> [V]	min	typ	max	unit
Normal mode consumption current (Note 10-1) (Note 10-2)	IDDOP(10)	V <sub>DD</sub> 1	<ul style="list-style-type: none"> <li>• FsX'tal=32.768kHz crystal oscillation mode</li> <li>• System clock set to 32.768kHz side</li> <li>• Internal low speed and medium speed RC oscillation stopped.</li> </ul>	1.8 to 5.5		34	97	μA
			<ul style="list-style-type: none"> <li>• Frequency variable RC oscillation stopped.</li> <li>• 1/2 frequency division ratio</li> </ul>	1.8 to 3.6		14	44	
	IDDOP(11)		<ul style="list-style-type: none"> <li>• FsX'tal=32.768kHz crystal oscillation mode</li> <li>• System clock set to 32.768kHz side</li> <li>• Internal low speed and medium speed RC oscillation stopped.</li> </ul>	5.0		34	88	
			<ul style="list-style-type: none"> <li>• Frequency variable RC oscillation stopped.</li> <li>• 1/2 frequency division ratio</li> <li>• Ta=-10 to +50°C</li> </ul>	3.3		14	36	
HALT mode consumption current (Note 10-1) (Note 10-2)	IDDHALT(1)		<ul style="list-style-type: none"> <li>• HALT mode</li> <li>• FmCF=12MHz ceramic oscillation mode</li> <li>• System clock set to 12MHz side</li> </ul>	2.7 to 5.5		2.6	4.8	mA
			<ul style="list-style-type: none"> <li>• Internal low speed and medium speed RC oscillation stopped.</li> <li>• Frequency variable RC oscillation stopped.</li> <li>• 1/1 frequency division ratio</li> </ul>	2.7 to 3.6		1.4	2.4	
	IDDHALT(2)		<ul style="list-style-type: none"> <li>• HALT mode</li> <li>• CF1=24MHz external clock</li> <li>• System clock set to CF1 side</li> </ul>	3.0 to 5.5		2.7	5.3	
			<ul style="list-style-type: none"> <li>• Internal low speed and medium speed RC oscillation stopped.</li> <li>• Frequency variable RC oscillation stopped.</li> <li>• 1/2 frequency division ratio</li> </ul>	3.0 to 3.6		1.6	2.9	
	IDDHALT(3)		<ul style="list-style-type: none"> <li>• HALT mode</li> <li>• FmCF=10MHz ceramic oscillation mode</li> <li>• System clock set to 10MHz side</li> </ul>	2.2 to 5.5		2.2	4.3	
			<ul style="list-style-type: none"> <li>• Internal low speed and medium speed RC oscillation stopped.</li> <li>• Frequency variable RC oscillation stopped.</li> <li>• 1/1 frequency division ratio</li> </ul>	2.2 to 3.6		1.2	2.2	
	IDDHALT(4)		<ul style="list-style-type: none"> <li>• HALT mode</li> <li>• FmCF=4MHz ceramic oscillation mode</li> <li>• System clock set to 4MHz side</li> </ul>	1.8 to 5.5		1.3	3.3	
			<ul style="list-style-type: none"> <li>• Internal low speed and medium speed RC oscillation stopped.</li> <li>• Frequency variable RC oscillation stopped.</li> <li>• 1/1 frequency division ratio</li> </ul>	1.8 to 3.6		0.56	1.2	
	IDDHALT(5)		<ul style="list-style-type: none"> <li>• HALT mode</li> <li>• CF oscillation low amplifier size selected. (CFLAMP=1)</li> <li>• FmCF=4MHz ceramic oscillation mode</li> <li>• System clock set to 4MHz side</li> </ul>	2.2 to 5.5		0.74	1.8	
			<ul style="list-style-type: none"> <li>• Internal low speed and medium speed RC oscillation stopped.</li> <li>• Frequency variable RC oscillation stopped.</li> <li>• 1/4 frequency division ratio</li> </ul>	2.2 to 3.6		0.34	0.68	
	IDDHALT(6)		<ul style="list-style-type: none"> <li>• HALT mode</li> <li>• FsX'tal=32.768kHz crystal oscillation mode</li> <li>• Internal low speed RC oscillation stopped.</li> </ul>	1.8 to 5.5		0.32	0.90	
			<ul style="list-style-type: none"> <li>• System clock set to internal medium speed RC oscillation</li> <li>• Frequency variable RC oscillation stopped.</li> <li>• 1/2 frequency division ratio</li> </ul>	1.8 to 3.6		0.21	0.44	

Note10-1: Values of the consumption current do not include current that flows into the output transistors and internal pull-up resistors.

Note10-2: The consumption current values do not include operational current of LVD function if not specified.

Continued on next page.

# LC87FBH08A

Continued from preceding page.

Parameter	Symbol	Pin/ remarks	Conditions	Specification				
				V <sub>DD</sub> [V]	min	typ	max	unit
HALT mode consumption current (Note 10-1) (Note 10-2)	IDDHALT(7)	V <sub>DD</sub> 1	<ul style="list-style-type: none"> <li>• HALT mode</li> <li>• FsX'tal=32.768kHz crystal oscillation mode</li> <li>• Internal low speed and medium speed RC oscillation stopped.</li> <li>• System clock set to 8MHz with frequency variable RC oscillation</li> <li>• 1/1 frequency division ratio</li> </ul>	1.8 to 5.5		1.3	2.3	mA
				1.8 to 3.6		0.91	1.5	
	IDDHALT(8)		<ul style="list-style-type: none"> <li>• HALT mode</li> <li>• External FsX'tal and FmCF oscillation stopped.</li> <li>• System clock set to internal low speed RC oscillation.</li> <li>• Internal medium speed RC oscillation stopped.</li> <li>• Frequency variable RC oscillation stopped.</li> <li>• 1/1 frequency division ratio</li> </ul>	1.8 to 5.5		18	68	μA
				1.8 to 3.6		11	35	
	IDDHALT(9)		<ul style="list-style-type: none"> <li>• HALT mode</li> <li>• External FsX'tal and FmCF oscillation stopped.</li> <li>• System clock set to internal low speed RC oscillation.</li> <li>• Internal medium speed RC oscillation stopped.</li> <li>• Frequency variable RC oscillation stopped.</li> <li>• 1/1 frequency division ratio</li> <li>• Ta=-10 to +50°C</li> </ul>	5.0		18	46	
				3.3		11	27	
				2.5		7.4	19	
	IDDHALT(10)		<ul style="list-style-type: none"> <li>• HALT mode</li> <li>• FsX'tal=32.768kHz crystal oscillation mode</li> <li>• System clock set to 32.768kHz side</li> <li>• Internal low speed and medium speed RC oscillation stopped.</li> <li>• Frequency variable RC oscillation stopped.</li> <li>• 1/2 frequency division ratio</li> </ul>	1.8 to 5.5		24	98	
				1.8 to 3.6		8.0	35	
	IDDHALT(11)		<ul style="list-style-type: none"> <li>• HALT mode</li> <li>• FsX'tal=32.768kHz crystal oscillation mode</li> <li>• System clock set to 32.768kHz side</li> <li>• Internal low speed and medium speed RC oscillation stopped.</li> <li>• Frequency variable RC oscillation stopped.</li> <li>• 1/2 frequency division ratio</li> <li>• Ta=-10 to +50°C</li> </ul>	5.0		24	63	
				3.3		8.0	23	
				2.5		3.5	11	
HOLD mode consumption current (Note 10-1) (Note 10-2)	IDDHOLD(1)	HOLD mode • CF1=V <sub>DD</sub> or open (External clock mode)	1.8 to 5.5		0.019	23		
			1.8 to 3.6		0.011	11		
	IDDHOLD(2)		5.0		0.019	1.2		
			3.3		0.011	0.59		
			2.5		0.010	0.30		
	IDDHOLD(3)		HOLD mode • CF1=V <sub>DD</sub> or open (External clock mode) • LVD option selected	1.8 to 5.5		2.6	26	
				1.8 to 3.6		2.0	13	
	IDDHOLD(4)		HOLD mode • CF1=V <sub>DD</sub> or open (External clock mode) • Ta=-10 to +50°C • LVD option selected	5.0		2.6	3.8	
3.3				2.0	2.8			
2.5				1.7	2.5			
Timer HOLD mode consumption current (Note 10-1) (Note 10-2)	IDDHOLD(5)	Timer HOLD mode • FsX'tal=32.768kHz crystal oscillation mode	1.8 to 5.5		22	84		
			1.8 to 3.6		6.5	30		
	IDDHOLD(6)		5.0		22	53		
			3.3		6.5	16		
		2.5		2.7	7.2			

Note10-1: Values of the consumption current do not include current that flows into the output transistors and internal pull-up resistors.

Note10-2: The consumption current values do not include operational current of LVD function if not specified.