



Chipsmall Limited consists of a professional team with an average of over 10 year of expertise in the distribution of electronic components. Based in Hongkong, we have already established firm and mutual-benefit business relationships with customers from,Europe,America and south Asia,supplying obsolete and hard-to-find components to meet their specific needs.

With the principle of “Quality Parts,Customers Priority,Honest Operation,and Considerate Service”,our business mainly focus on the distribution of electronic components. Line cards we deal with include Microchip,ALPS,ROHM,Xilinx,Pulse,ON,Everlight and Freescale. Main products comprise IC,Modules,Potentiometer,IC Socket,Relay,Connector.Our parts cover such applications as commercial,industrial, and automotives areas.

We are looking forward to setting up business relationship with you and hope to provide you with the best service and solution. Let us make a better world for our industry!



## Contact us

Tel: +86-755-8981 8866 Fax: +86-755-8427 6832

Email & Skype: info@chipsmall.com Web: www.chipsmall.com

Address: A1208, Overseas Decoration Building, #122 Zhenhua RD., Futian, Shenzhen, China





# POWER

## LCC250

250 Watts Convection/Conduction Mounting

### Data Sheet

**Total Power:** 250 W  
**# of Outputs:** Single  
**Outputs:** 12, 24, 48 V

### SPECIAL FEATURES

- 250 W full power at elevated temperatures
- Wide operating temperature range suited for outdoor application
- IP64 rated
- Conduction-cooled or convection
- Differential remote sense
- Output adjust
- Output On/Off (Positive or Negative logic user selectable)

### COMPLIANCE

- EMI Class B
- EN61000 Immunity
- MIL-STD-461E: CE101; CE102; CS101; CS114

### SAFETY

- UL + CSA: 60950-1 2nd Ed. ANSI ES60601-1 3rd Ed
- TUV: 60950-1 2nd Ed. 60601-1 3rd Ed. 61347-1; 2-13
- CB Scheme: IEC 60950-1 2nd Ed IEC 61347-1; 2-13 IEC 60601-1
- China CCC<sup>5</sup>
- CE Mark



### Electrical Specifications

Input	
Input range	90 - 264 Vac (Operating) 115/230 Vac (Nominal)
Frequency	47 - 63 Hz
Input fusing	Internal fuse on both L and N lines
Inrush current	50 A
Power factor	> 0.92 Full load
Harmonics	Meets EN61000-3-2; MIL-STD-461E <sup>(6)</sup> ; CE101; CE102; CS101; CS104
Input current	3.4 A @ 90 Vac full load
Hold up time	16 ms minimum at 115 Vac; 100% load
Efficiency	230 Vac; 100% load 12 V - 89% typical 24 V - 91% typical 48 V - 91.5% typical
Leakage current	< 275 $\mu$ A at 230 Vac

## Electrical Specifications

Output		
Output rating	12 V @ 20.8 A 24 V @ 10.4 A 48 V @ 5.2 A	
Set point	±0.2%	Factory set point
Total regulation range	±2%	Line/Load/Temperature
Rated load	250 W maximum	
Minimum load	0 A Load	No loss of regulation
Capacitive load	0 - 330 $\mu$ F/Amp	
Output voltage overshoot		No overshoot/undershoot outside the regulation band during on or off cycle
Constant output voltage adjustment range	12 V: +10 / -10% 24 V: +14.6 / -15% 48 V: +15% / -15%	Adjust via VR2
Constant output current adjustment range	+0 / -50%	Adjust via VR1 CC mode supported from $V_o$ nominal down to 80% $V_o$
Output ripple and noise	1%	0 to 330 $\mu$ F/Amp
Transient response	±5% $V_o$ max transient; recovery < 500 $\mu$ s max	50% Load Step @ 1 A/ $\mu$ s Step Load verified at: 50% to 100% Load; 90 - 264 Vac input; Capacitive load from 0 to 330 $\mu$ F/Amp
Remote sense	Capable of Stable Offset of ±0.5 Vdc at output cable termination	+SENSE (Red Wire); -SENSE (Black Wire)
Output On/Off	Remote On/Off referenced to secondary side. Positive or Negative logic user selectable via CN2. Factory default is Positive logic	On/Off (Orange Wire); On/Off Return (White Wire)
Overcurrent protection (OCP)	≤ 150% $I_o$	Auto-recovery
Overvoltage protection (OVP)	110% to 135% $V_o$	Latching mode; Requires input AC recycle
Overtemperature Protection (OTP)		Auto-recovery; hiccup mode
Output isolation	4000 Vac Input to Output 1500 Vac Input to Ground 500 Vac Output to Ground	

## Environmental Specifications

<b>Operating temperature</b>	Suffix 4P (Conduction): -40 °C to +85 °C Baseplate Temperature Suffix 7P (Convection): -40 °C to +85 °C Ambient Temperature
<b>Storage temperature</b>	-40 °C to +85 °C
<b>Humidity</b>	10% to 100% (Condensing & Non-Condensing)
<b>Altitude</b>	Operating: 13,000 feet Non-Operating: 50,000 feet
<b>Shock</b>	IEC68-2-27
<b>Vibration</b>	IEC68-2-6 / IEC721-3-2
<b>Ingress Protection</b>	IP64 Rated
<b>MTBF (Calculated)</b>	> 780,000 hours at 100% load; Low line; Telcordia SR-332

## Ordering Information

Model Number	Output	Adjustment Range	Output Current		Output Ripple P/P <sup>1</sup>	Line/ Load Regulation
			Min	Max		
LCC250-12U-4P	12 V	±10%	0 A	20.8 A	1% <sup>2</sup>	±2%
LCC250-12U-4PE	12 V	±10%	0 A	20.8 A	1% <sup>2</sup>	±2%
LCC250-12U-7P	12 V	±10%	0 A	20.8 A	1% <sup>2</sup>	±2%
LCC250-12U-7PE	12 V	±10%	0 A	20.8 A	1% <sup>2</sup>	±2%
LCC250-24U-4P	24 V	+14.6 / -15%	0 A	10.4 A	1% <sup>3</sup>	±2%
LCC250-24U-4PE	24 V	+14.6 / -15%	0 A	10.4 A	1% <sup>3</sup>	±2%
LCC250-24U-7P	24 V	+14.6 / -15%	0 A	10.4 A	1% <sup>3</sup>	±2%
LCC250-24U-7PE	24 V	+14.6 / -15%	0 A	10.4 A	1% <sup>3</sup>	±2%
LCC250-48U-4P	48 V	±15%	0 A	5.2 A	1% <sup>4</sup>	±2%
LCC250-48U-4PE	48 V	±15%	0 A	5.2 A	1% <sup>4</sup>	±2%
LCC250-48U-7P	48 V	±15%	0 A	5.2 A	1% <sup>4</sup>	±2%
LCC250-48U-7PE	48 V	±15%	0 A	5.2 A	1% <sup>4</sup>	±2%

- Output ripple measured at the end of the output cable terminated with 10  $\mu$ F tantalum cap in parallel with 0.1  $\mu$ F ceramic capacitor.
- 12 V: 1% limit is achieved with 2X 820  $\mu$ F/16 V external cap (e.g. PLG1C821MDO1 from Nichicon or equivalent). Otherwise, maximum limits are 1.5% at  $T_a \geq 0$  °C and 2.0% max at  $T_a < 0$  °C.
- 24 V: 1% limit is achieved with 2X 820  $\mu$ F/35 V external cap (e.g. UPM1V821MHD1TO from Nichicon or equivalent). Otherwise, maximum limits are 1.5% at  $T_a \geq -10$  °C. 2.0% max ripple at  $T_a < -10$  °C is met with below external capacitance:

Ambient Temperature (°C)	-20	-25	-30	-35	-40
Recommended External Capacitors ( $\mu$ F)	1000	2200	3300	12000	22000

- 48 V: 1% limit is achieved with 3X 470  $\mu$ F/63 V external cap. Otherwise, maximum limits are 1.5% max at  $T_a \geq 0$  °C and 2% max at  $T_a < 0$  °C.
- Safety Approvals: China CCC approval applies to part numbers with “-xxE” suffixes only.
- 12 V unit requires external filtering for MIL-STD-461E compliance. Consult Artesyn Technical Support.
- Warranty: 2 years

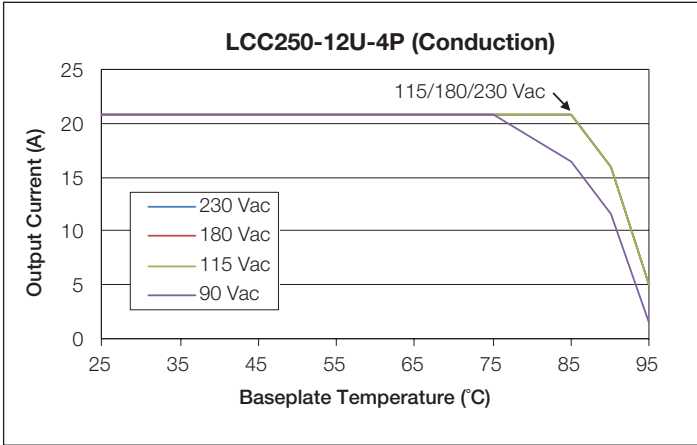

Fig 1. 12 V "4P" Suffix (Conduction) Output Current Derating

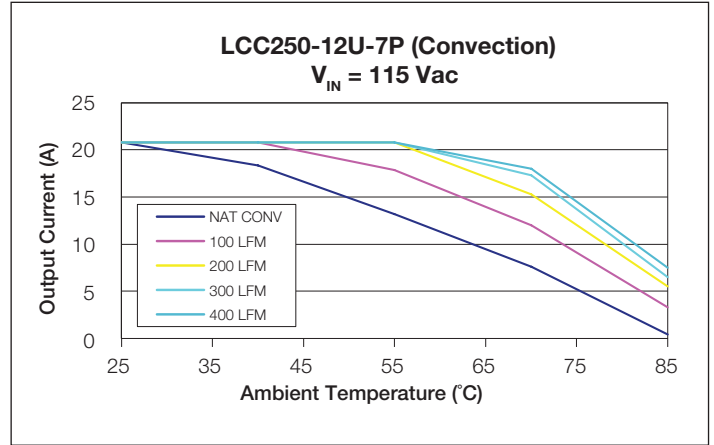

Fig 2. 12 V "7P" Suffix (Convection) Output Current Derating at 115 Vac

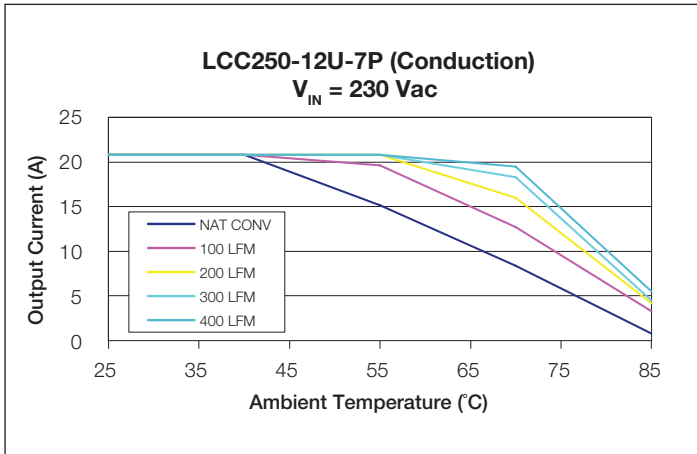

Fig 3. 12 V "7P" Suffix (Convection) Output Current Derating at 230 Vac

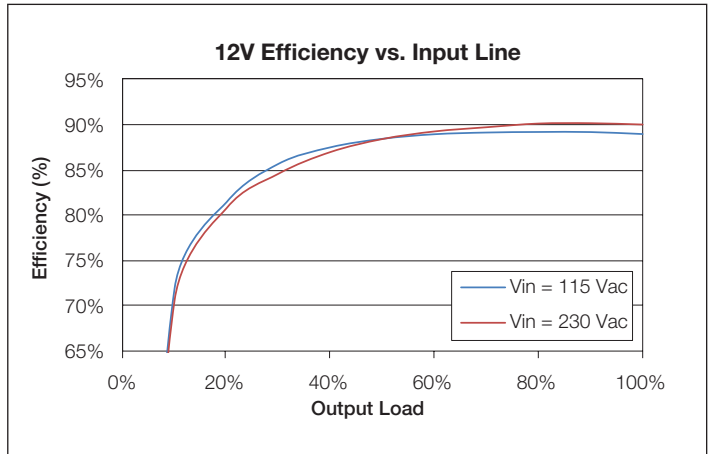

Fig 4. 12 V Efficiency Curve

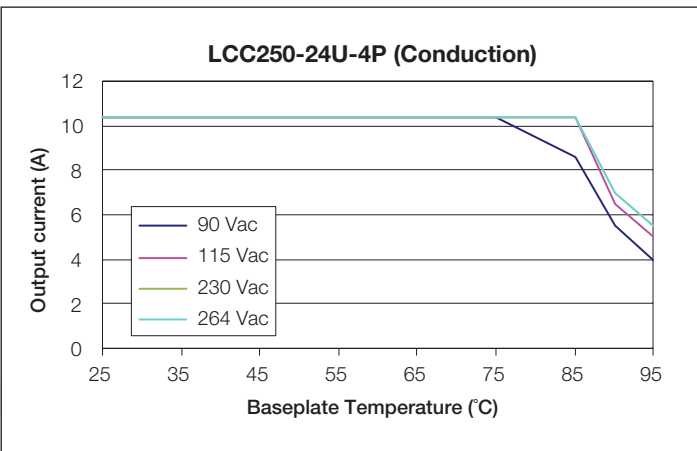

Fig 5. 24 V "4P" Suffix (Conduction) Output Current Derating

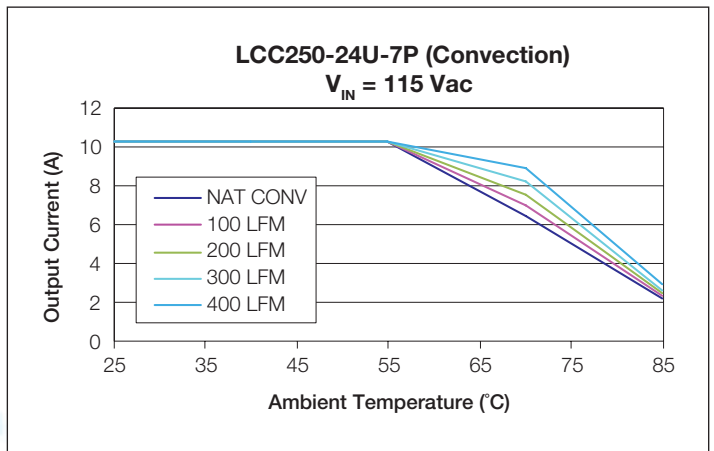

Fig 6. 24 V "7P" Suffix (Convection) Output Current Derating at 115 Vac



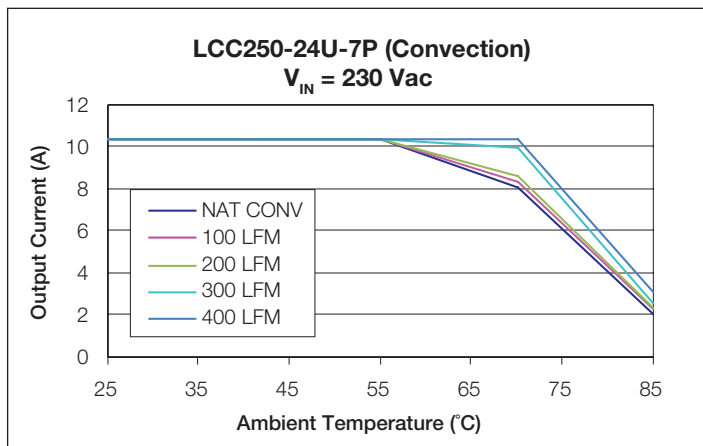

Fig 7. 24 V “7P” Suffix (Convection) Output Current Derating at 230 Vac

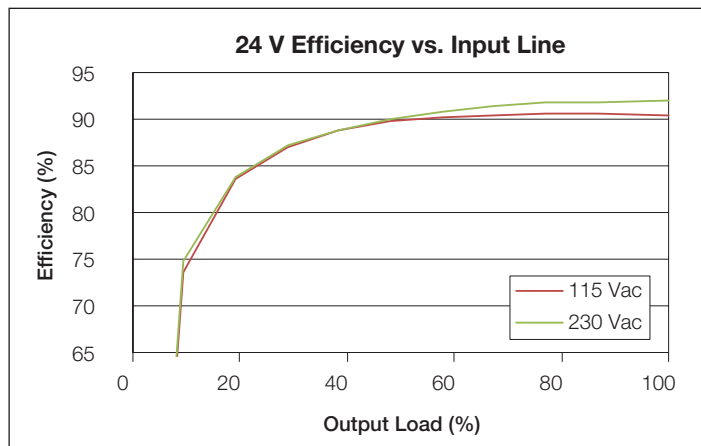

Fig 8. 24 V Efficiency Curve

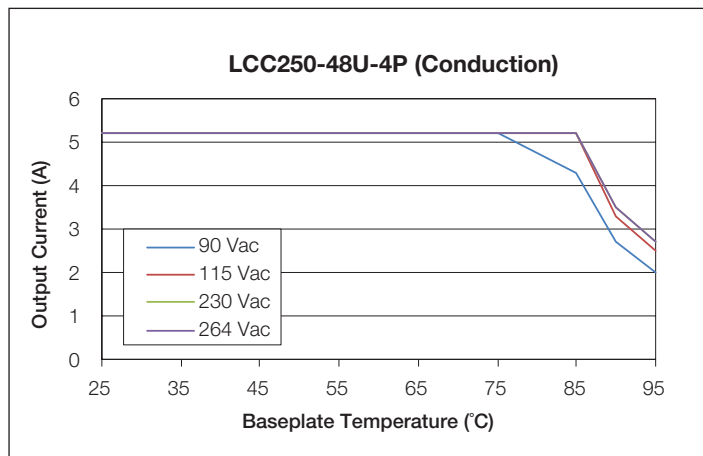

Fig 9. 48 V “4P” Suffix (Conduction) Output Current Derating

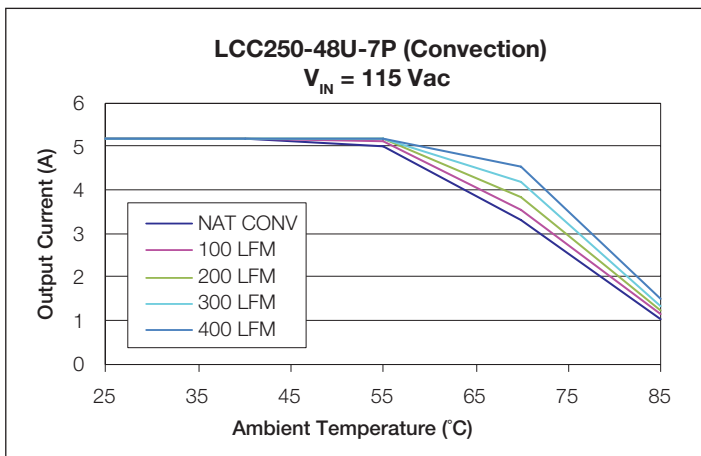

Fig 10. 48 V “7P” Suffix (Convection) Output

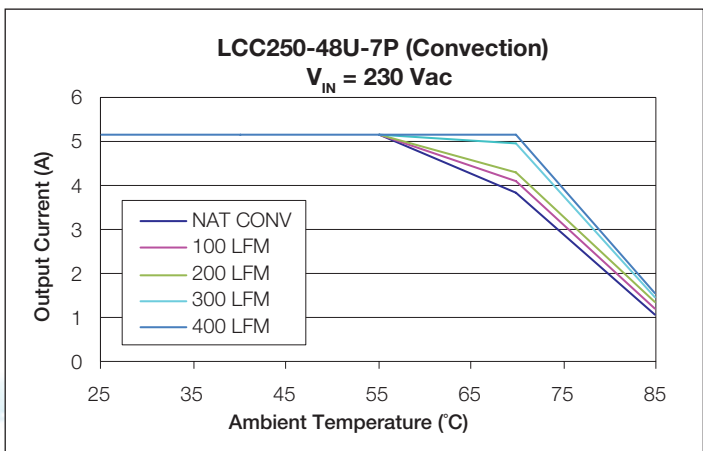

Fig 11. 48 V “7P” Suffix (Convection) Output Current Derating at 230 Vac

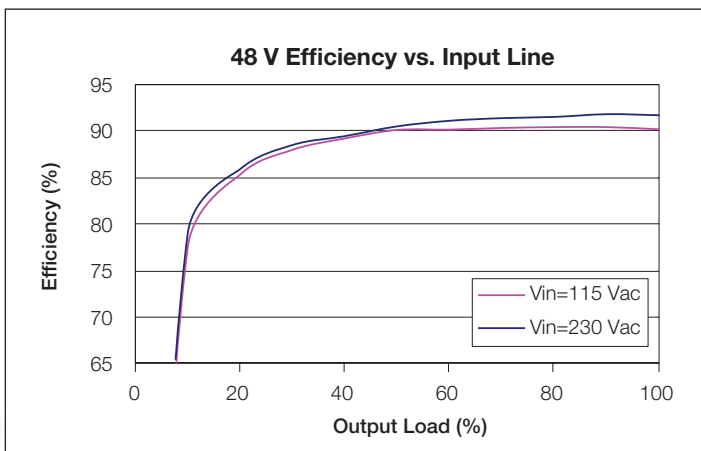
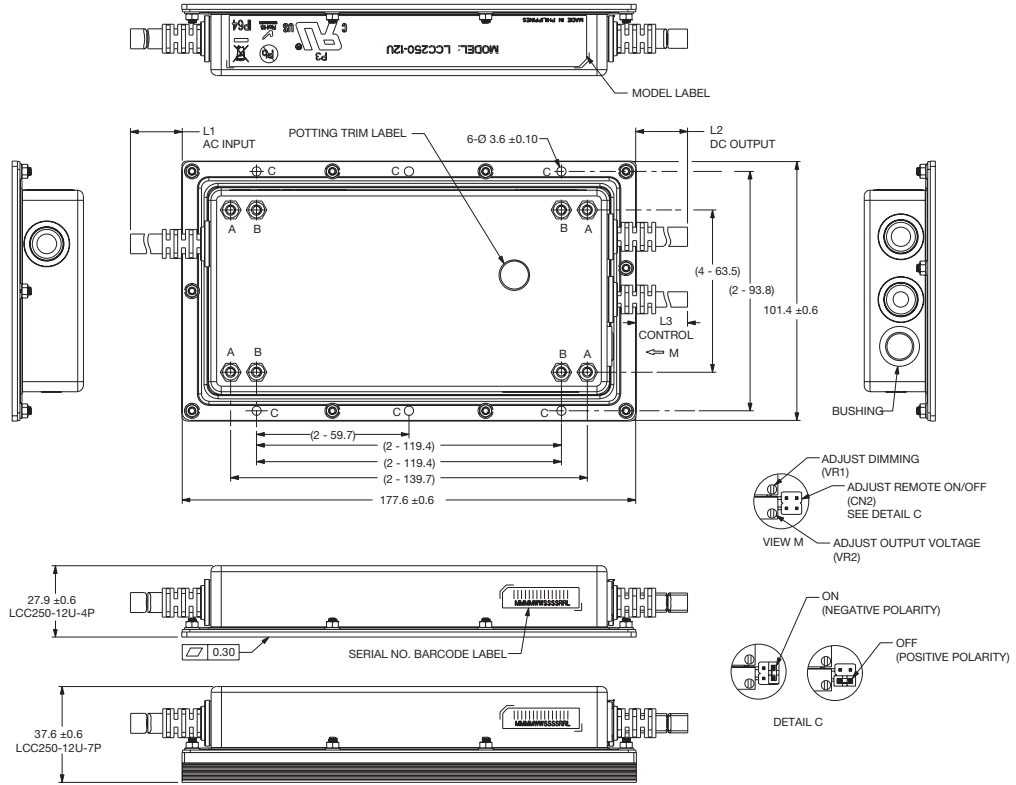

Fig 12. 48 V Efficiency Curve

Mechanical Drawings

12 V



24 V / 48 V

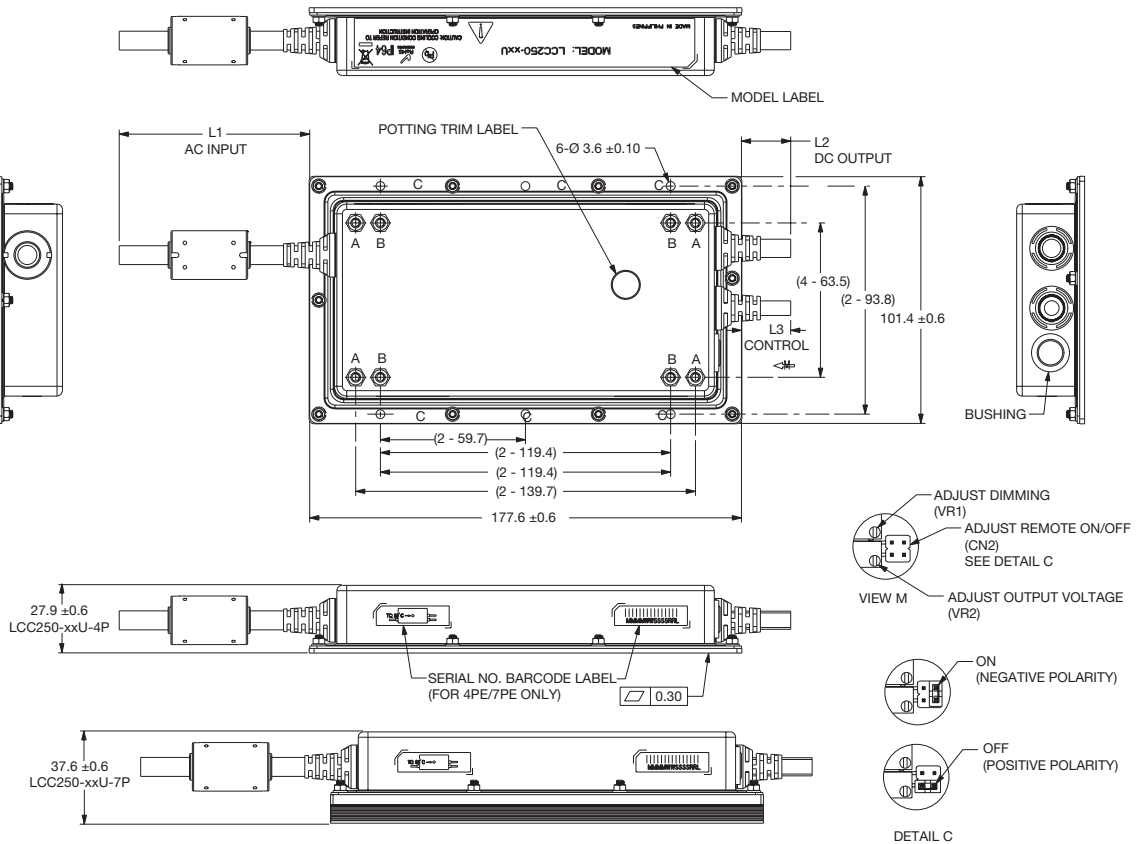

Cable	Length	Designation	Wire Color	Wire Gauge
AC Input Cable	L1 = 300 ±10 mm	L = Live	Brown	AWG#18
		N = Neutral	Blue	AWG#18
		PE = Primary Earth	Green/Yellow	AWG#18
DC Output Cable	L2 = 300 ±10 mm	+Output	Blue	AWG#14
		-Output	Gray	AWG#14
Control Cable	L3 = 300 ±10 mm	Dimming	Brown	AWG#26
		Dimming Return	Yellow	AWG#26
		ON/OFF	Orange	AWG#26
		ON/OFF Return	White	AWG#26
		Sense	Red	AWG#26
		Sense Return	Black	AWG#26

## WORLDWIDE OFFICES

### Americas

2900 S.Diablo Way  
Tempe, AZ 85282  
USA  
+1 888 412 7832

### Europe (UK)

Waterfront Business Park  
Merry Hill, Dudley  
West Midlands, DY5 1LX  
United Kingdom  
+44 (0) 1384 842 211

### Asia (HK)

14/F, Lu Plaza  
2 Wing Yip Street  
Kwun Tong, Kowloon  
Hong Kong  
+852 2176 3333

**ARTESYN**<sup>™</sup>  
EMBEDDED TECHNOLOGIES

[www.artesyn.com](http://www.artesyn.com)

Artesyn Embedded Technologies, Artesyn and the Artesyn Embedded Technologies logo are trademarks and service marks of Artesyn Embedded Technologies, Inc. All other names and logos referred to are trade names, trademarks, or registered trademarks of their respective owners. © 2015 Artesyn Embedded Technologies, Inc. All rights reserved. For full legal terms and conditions, please visit [www.artesyn.com/legal](http://www.artesyn.com/legal).

For more information: [www.artesyn.com/power](http://www.artesyn.com/power)  
For support: [productsupport.ep@artesyn.com](mailto:productsupport.ep@artesyn.com)