



Chipsmall Limited consists of a professional team with an average of over 10 year of expertise in the distribution of electronic components. Based in Hongkong, we have already established firm and mutual-benefit business relationships with customers from,Europe,America and south Asia,supplying obsolete and hard-to-find components to meet their specific needs.

With the principle of “Quality Parts,Customers Priority,Honest Operation,and Considerate Service”,our business mainly focus on the distribution of electronic components. Line cards we deal with include Microchip,ALPS,ROHM,Xilinx,Pulse,ON,Everlight and Freescale. Main products comprise IC,Modules,Potentiometer,IC Socket,Relay,Connector.Our parts cover such applications as commercial,industrial, and automotives areas.

We are looking forward to setting up business relationship with you and hope to provide you with the best service and solution. Let us make a better world for our industry!



Contact us

Tel: +86-755-8981 8866 Fax: +86-755-8427 6832

Email & Skype: info@chipsmall.com Web: www.chipsmall.com

Address: A1208, Overseas Decoration Building, #122 Zhenhua RD., Futian, Shenzhen, China



Photoelectrics Laser, Retro-reflective, Polarized Type LD32CNP10

CARLO GAVAZZI

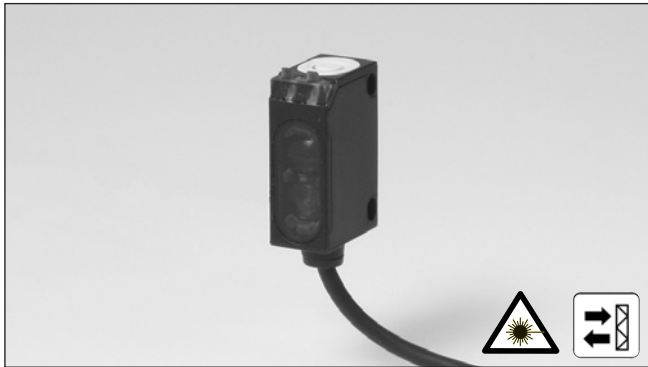

- Miniature sensor range
- Range: 0.1-1 m, with reflector
- Sensitivity adjustment by Teach-In programming
- Modulated, red laser light 650 nm, polarized (class 2)
- Supply voltage: 10 to 30 VDC
- Output: 100 mA, NPN or PNP preset
- Make and break switching function programmable
- LED for output indication and power ON
- Protection: reverse polarity, short circuit and transients
- Cable and plug versions
- Excellent EMC performance



Product Description

The LD32CNP10 sensor family comes in a compact 12 x 32 x 20 mm reinforced PMMA/ABS-housing. The sensors are useful in applications where high-accuracy detection as well as small size is required. The Teach-In function for

adjustment of the sensitivity makes the sensors highly flexible. The output type is preset (NPN or PNP), and the output switching function is programmable (NO or NC). The small laser spot makes it possible to detect small objects very precisely.

Ordering Key

LD32CNP10PPM5T

Type	_____
Housing style	_____
Housing size	_____
Housing material	_____
Housing length	_____
Detection principle	_____
Sensing distance	_____
Output type	_____
Output configuration	_____
Connection type	_____
Teach-In	_____

Type Selection

Housing W x H x D	Range S _n	Ordering no. NPN & PNP cable Make & break switching	Ordering no. NPN & PNP plug Make & break switching
12 x 32 x 20 mm	1.0 m	LD 32 CNP 10 NPT LD 32 CNP 10 PPT	LD 32 CNP 10 NPM5T LD 32 CNP 10 PPM5T

Specifications

Rated operating distance (S_n)	Up to 1.0 m, with reflector 51 x 51 mm (ER5060)	Protection	Short-circuit, reverse polarity and transients
Blind zone	100 mm	Laser protection class	Class 2 - according to EN60825-1-3/97
Sensitivity	Adjustable by Teach-In (push button or wire)	Average power	< 1 mW
Temperature drift	≤ 1%/°C	Pulse width	t = 3 μs
Hysteresis (H) (differential travel)	≤ 10%	Pulse repetition time	f = 5 kHz
Rated operational volt. (U_B)	10 to 30 VDC (ripple included)	MTBF	> 50'000 h @ T _a = 40°C
Ripple (U_{ripp})	≤ 10%	Light source	Red laser light, 650 nm
Output current Continuous (I _a) Short-time (I)	≤ 100 mA ≤ 100 mA (max. load capacity 100 nF)	Light type	Red, modulated
No load supply current (I_o)	≤ 25 mA @ 24 VDC	Sensing angle	< 0.8°
Minimum operational current (I_m)	0.5 mA	Ambient light	5,000 lux
OFF-state current (I_r)	≤ 100 μA	Light spot	< 1 mm @ 300 mm
Voltage drop (U_d)	≤ 2.4 VDC @ 100 mA	Operating frequency	1000 Hz
		Response time OFF-ON (t _{ON}) ON-OFF (t _{OFF})	≤ 0.5 ms ≤ 0.5 ms
		Power ON delay (t_v)	≤ 300 ms
		Output function NPN and PNP NO/NC switching function	Preset Set up by button

Specifications (cont.)

External Teach (ET) Same function as button Locked (disable teach button) Operating mode	10 to 30 VDC 0 to 2.5 VDC Not connected	Vibration Shock	10 to 55 Hz, 0.5 mm/7.5 g (IEC 60068-2-6) 30 g / 11ms, 3 pos, 3 neg per axis (IEC 60068-2-6, 60068-2-32)
Indication Output ON Signal stability ON and power ON	LED, yellow LED, green	Rated insulation voltage Housing material Body Front material	500 VAC (rms) ABS, black PMMA, red
Environment Installation category Pollution degree Degree of protection	II (IEC 60664/60664A; 60947-1) 3 (IEC 60664/60664A; 60947-1) IP 67 (IEC 60529; 60947-1)	Connection Cable Plug	PUR, black, 2 m 4 x 0.14 mm ² , Ø = 3.6 mm M8, 4-pin
Ambient temperature Operating Storage	-20 to +60° C (-4 to +140° F) -20 to +80° C (-4 to +176° F)	Weight CE-marking	Cable type: 40 g Plug type: 10 g Yes

Operation Diagram

tv = Power ON delay

Power supply

Object/target present

Break (NC) Output ON

Make (NO) Output ON

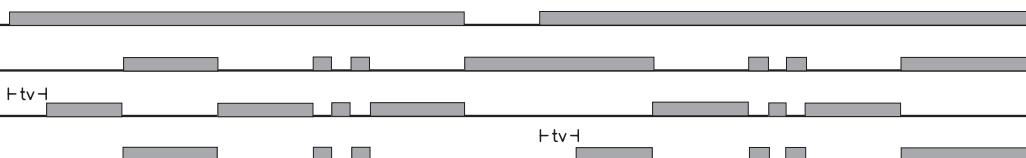

Wiring Diagrams

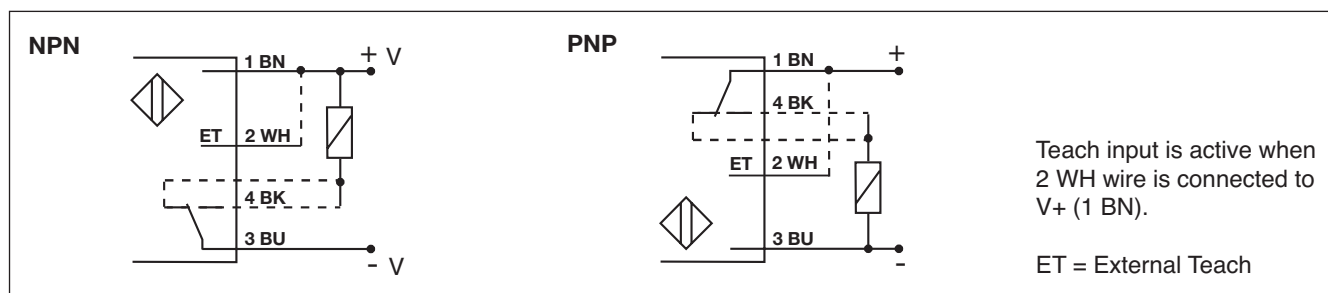

Installation Hints

<p>To avoid interference from inductive voltage/current peaks, separate the prox. switch power cables from any other power cables, e.g. motor, contactor or solenoid cables</p>	<p>Relief of cable strain</p> <p>The cable should not be pulled</p>	<p>Protection of the sensing face</p> <p>A proximity switch should not serve as mechanical stop</p>	<p>Switch mounted on mobile carrier</p> <p>Any repetitive flexing of the cable should be avoided</p>
---	---	---	--

Dimensions

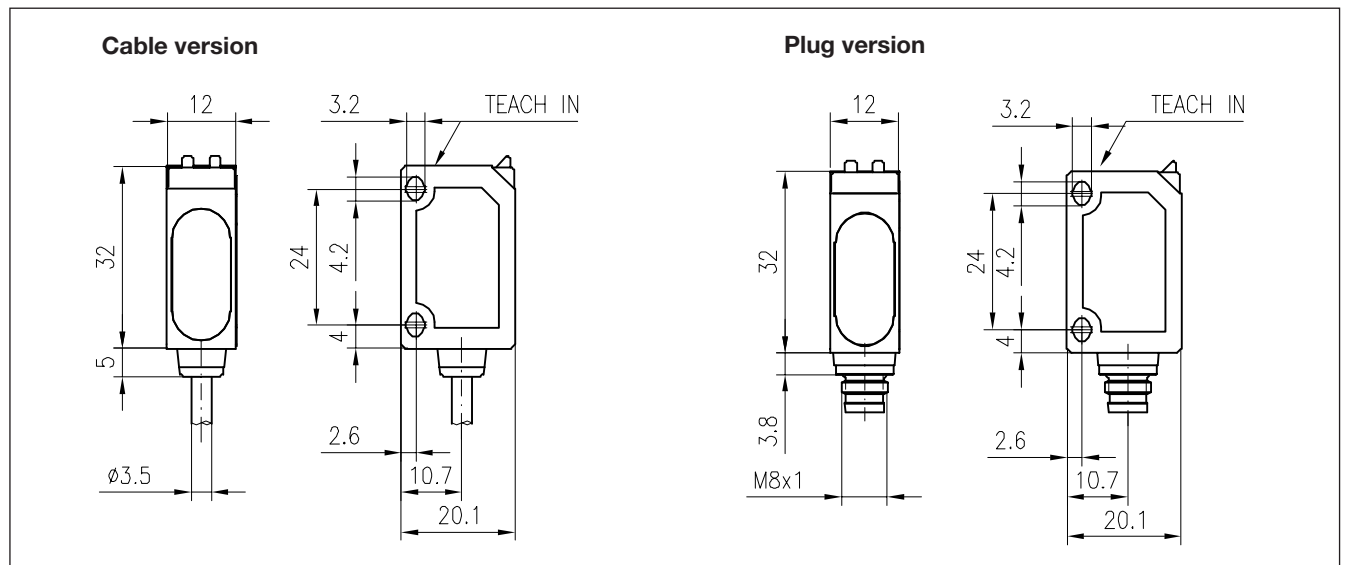

Signal Stability Indication

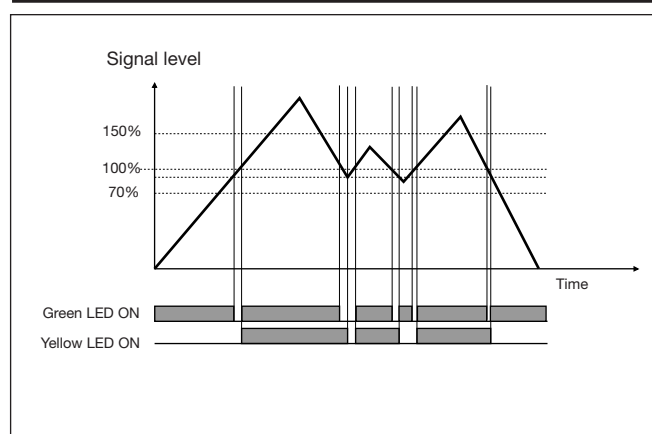

Accessories

Mounting bracket APD32-MB3

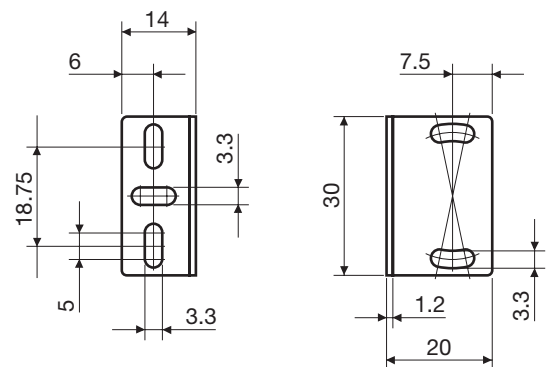

For further information refer to "Accessories"

Delivery Contents

- Photoelectric switch: LD 32 CNP 10
- Installation instruction
- **Packaging:** Cardboard box

Adjustment

Sensitivity adjustment, with static object (needed for transparent objects only)

1. Line up the sensor with the reflector. Yellow LED and green LED are ON.
2. Press the button for 3 s until both LED's flash simultaneously (the first switching point is stored).
3. Place the object in the detection area.
4. Press the button for 1 s.
 - a) The green LED flashes and stays ON: the second switching point is stored, and the sensor is ready to operate.
 - b) Both LED's flash simultaneously: the sensor cannot detect the object, no switching points are stored.

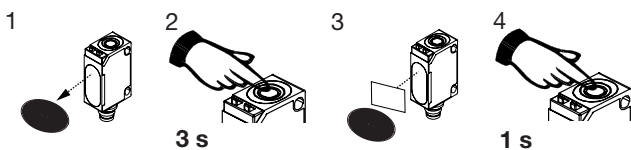



Adjustment to maximum sensitivity

1. Line up the sensor with the reflector. Press the button for 3 s until both LED's flash simultaneously.
2. Press the button again for 1 s (without object). The sensor is set to maximum sensitivity.

Sensitivity adjustment, with a running process (needed for transparent objects only)

1. Line up the sensor with the reflector. Green LED is ON. At this stage the status of the yellow LED can be ignored.
2. The running process must be the only "object" within the detection area. Press the button for 3 s until both LED's flash simultaneously.

 3 s
3. Press the button for at least the duration of one process cycle.



 1 cycle

 - a) The green LED flashes and stays ON: both switching points have been stored, and the sensor is ready to operate.
 - b) Both LED's flash simultaneously: the sensor cannot detect the object, no switching points are stored.

Programming of make and break switching function

1. Press the button for 13 s.  13 s
Both LED's flash alternately.
2. Release the button: the green LED flashes.
3. While the green LED flashes, the output is inverted each time the button is pressed. This is indicated by the yellow LED.
When the button is not pressed for 10 s, the current output function is stored.
The sensor is now ready for operation.

Default setting

1. Cover light emitter and receiver: Press the button for 3 s, until both LED's flash simultaneously.  3 s
2. Keep light emitter and receiver covered: Press the button for 1 s.  1 s
The sensor is set to maximum sensitivity.

NB! The Teach Input (2 WH) will work similarly to the push button, active High.