



Chipsmall Limited consists of a professional team with an average of over 10 year of expertise in the distribution of electronic components. Based in Hongkong, we have already established firm and mutual-benefit business relationships with customers from,Europe,America and south Asia,supplying obsolete and hard-to-find components to meet their specific needs.

With the principle of “Quality Parts,Customers Priority,Honest Operation,and Considerate Service”,our business mainly focus on the distribution of electronic components. Line cards we deal with include Microchip,ALPS,ROHM,Xilinx,Pulse,ON,Everlight and Freescale. Main products comprise IC,Modules,Potentiometer,IC Socket,Relay,Connector.Our parts cover such applications as commercial,industrial, and automotives areas.

We are looking forward to setting up business relationship with you and hope to provide you with the best service and solution. Let us make a better world for our industry!



Contact us

Tel: +86-755-8981 8866 Fax: +86-755-8427 6832

Email & Skype: info@chipsmall.com Web: www.chipsmall.com

Address: A1208, Overseas Decoration Building, #122 Zhenhua RD., Futian, Shenzhen, China



1.2 A high PSRR low-dropout linear voltage regulator

Datasheet - production data



Features

- Input voltage from 2.5 V to 18 V
- 20 V AMR
- Available on fixed output voltages: 1.2 V (1.185 V), 1.5 V, 1.8 V, 2.5 V, 3 V, 3.3 V, 5.0 V (other options are available on request)
- Guaranteed output current 1.2 A
- Typical dropout 350 mV@1.2 A
- Internal thermal, current and power limitation
- High PSRR 87 dB @120 Hz
- Operating temperature range: -40 °C to 125 °C package SOT223

Applications

- Consumer
- Industrial
- SMPS
- Motherboard P.O.L.
- DC-DC post-regulation

Description

The LDL1117 provides 1.2 A of maximum current with an input voltage range from 2.5 V to 18 V, and a typical dropout voltage of 350 mV@1.2 A.

The high power supply rejection ratio of 87 dB at 120 Hz, rolling down to more than 40 dB at 100 kHz, makes the LDL1117 suitable for direct regulations in SMPS and secondary linear regulations in DC-DC converters.

This device includes current limit, SOA and thermal protections.

Contents

1	Block diagram.....	5
2	Pin configuration	6
3	Typical application	7
4	Maximum ratings	8
5	Electrical characteristics	9
6	Application information	10
	6.1 Thermal and short-circuit protections	10
	6.2 Input and output capacitor selection.....	10
7	Typical performance characteristics	11
8	Package information	16
	8.1 SOT223 package information.....	16
9	Ordering information.....	18
10	Revision history	19

List of tables

Table 1: Pin description	6
Table 2: Absolute maximum ratings	8
Table 3: Thermal data.....	8
Table 4: Electrical characteristics	9
Table 5: SOT223 package mechanical data	17
Table 6: Order code	18
Table 7: Document revision history	19

List of figures

Figure 1: Block diagram	5
Figure 2: Pin configuration (top view)	6
Figure 3: Typical application schematic	7
Figure 4: Output voltage vs temperature (VIN = 2.6 V, VOUT = 1.2 V, no-load)	11
Figure 5: Output voltage vs temperature (VIN = 2.6 V, VOUT = 1.2, 1200 mA)	11
Figure 6: Output voltage vs temperature (VIN = 6 V, VOUT = 5 V, no-load)	11
Figure 7: Output voltage vs temperature (VIN = 6 V, VOUT = 5 V, 1200 mA)	11
Figure 8: Line regulation vs temperature (VIN = 6 to 18 V, VOUT = 5 V, IOU = 10 mA)	12
Figure 9: Line regulation vs temperature (VIN = 2.5 to 18 V, VOUT = 1.2 V, IOU = 10 mA)	12
Figure 10: Load regulation vs temperature (VIN = 6 V, VOUT = 5 V, IOU = 10 to 1200 mA)	12
Figure 11: Load regulation vs temperature (VIN = 2.6 V, VOUT = 1.2 V, IOU = 10 to 1200 mA)	12
Figure 12: Dropout voltage vs temperature	12
Figure 13: Quiescent current vs temperature (no-load)	12
Figure 14: Quiescent current vs temperature (600 mA)	13
Figure 15: Quiescent current vs temperature (1.2 A)	13
Figure 16: Short-circuit current vs dropout voltage (VOUT = 5 V)	13
Figure 17: Short-circuit current vs dropout voltage (VOUT = 1.2 V)	13
Figure 18: SVR vs frequency	13
Figure 19: Output noise spectral density (VO = 1.2 V)	13
Figure 20: Stability plan (VOUT = 5 V)	14
Figure 21: Stability plan (VOUT = 1.2 V)	14
Figure 22: Turn-on time (VOUT = 5 V)	14
Figure 23: Turn-on time (VOUT = 1.2 V)	14
Figure 24: Line transient (VOUT = 5 V)	14
Figure 25: Line transient (VOUT = 1.2 V)	14
Figure 26: Load transient (VOUT = 1.2 V)	15
Figure 27: Load transient (VOUT = 5 V)	15
Figure 28: SOT223 package outline	16

1 Block diagram

Figure 1: Block diagram

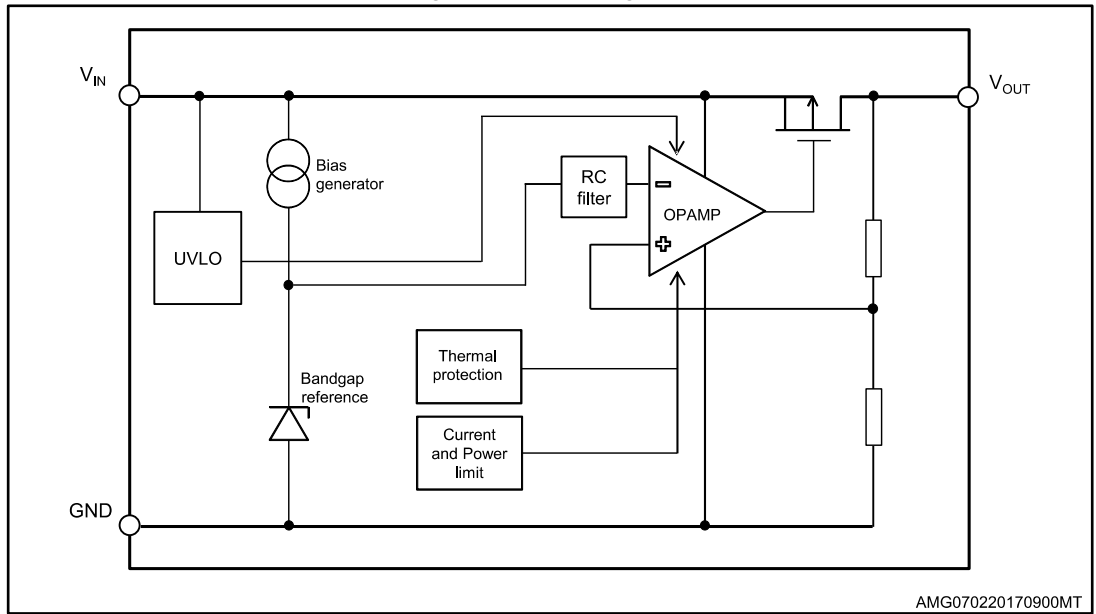

2 Pin configuration

Figure 2: Pin configuration (top view)

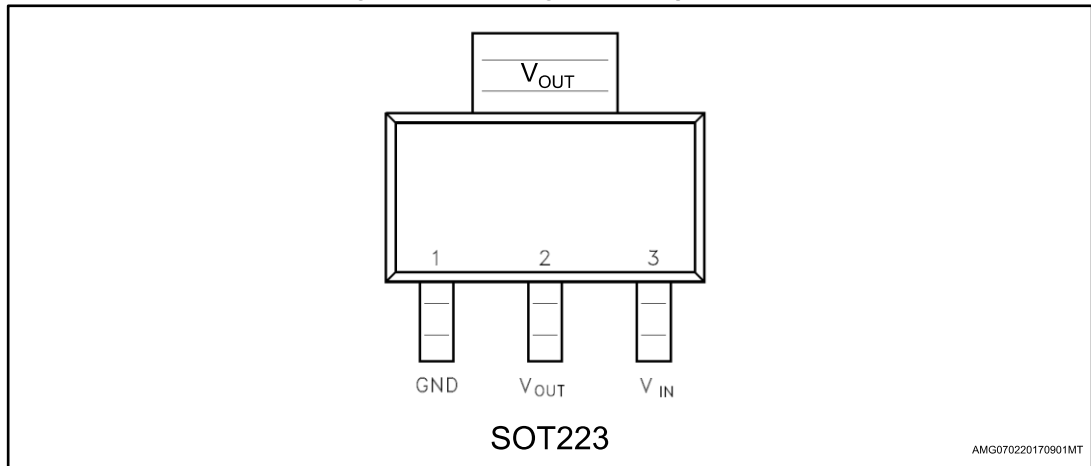

Table 1: Pin description

Pin name	Pin number	Description
GND	1	Ground
V _{OUT}	2	Output voltage
V _{IN}	3	Input voltage



The tab is connected to V_{OUT}.

3 Typical application

Figure 3: Typical application schematic

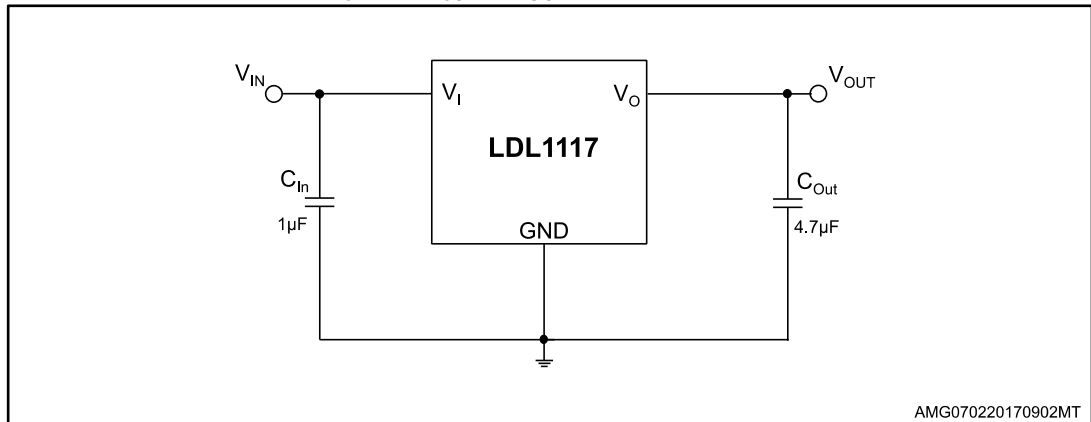

4 Maximum ratings

Table 2: Absolute maximum ratings

Symbol	Parameter	Value	Unit
V_{IN}	Input supply voltage	-0.3 to 20	V
V_{OUT}	Output voltage	-0.3 to $V_{IN} + 0.3$	V
I_{OUT}	Output current	Internally limited	A
P_d	Power dissipation	Internally limited	W
T_{J-OP}	Operating junction temperature	-40 to 125	°C
T_{J-MAX}	Maximum junction temperature	150	°C
T_{STG}	Storage temperature	-55 to 150	°C



Absolute maximum ratings are those values beyond which damage to the device may occur. Functional operation under these conditions is not implied.

Table 3: Thermal data

Symbol	Parameter	Value	Unit
θ_{J-C}	Thermal resistance junction-to-case	15	°C/W
θ_{J-A}	Thermal resistance junction-to-ambient	120	

5 Electrical characteristics

($T_J = 25\text{ °C}$, $V_{IN} = V_{OUT} + 1\text{ V}$ or 2.6 V , whichever is greater; $C_{IN} = 1\text{ }\mu\text{F}$; $C_{OUT} = 4.7\text{ }\mu\text{F}$; $I_{OUT} = 10\text{ mA}$)

Table 4: Electrical characteristics

Symbol	Parameter	Test conditions	Min.	Typ.	Max.	Unit
V_{IN}	Operating input voltage		2.6		18	V
V_{UVLO}	Turn-on threshold			2.3	2.4	V
	Hysteresis			200		mV
V_{OUT}	V_{OUT} accuracy	$I_{OUT} = 10\text{ mA}$, $T_J = 25\text{ °C}$	-2		+2	%
		$I_{OUT} = 10\text{ mA}$, $-40\text{ °C} < T_J < 125\text{ °C}$	-3		+3	%
ΔV_{OUT}	Line regulation	$V_{OUT} + 1\text{ V}^{(1)} \leq V_{IN} \leq 18\text{ V}$, $I_{OUT} = 10\text{ mA}$, $-40\text{ °C} < T_J < 125\text{ °C}$		0.002	0.02	%/V
ΔV_{OUT}	Load regulation	$I_{OUT} = 10\text{ mA}$ to 1.2 A , $-40\text{ °C} < T_J < 125\text{ °C}$		5	15	mV
V_{DROP}	Dropout voltage ⁽²⁾	$I_{OUT} = 1.2\text{ A}$, $V_{OUT} > 2.5\text{ V}$ - $40\text{ °C} < T_J < 125\text{ °C}$		350	600	mV
eN	Output noise voltage	10 Hz to 100 kHz, $I_{OUT} = 100\text{ mA}$		60		$\mu\text{V}_{RMS}/V_{OUT}$
SVR	Supply voltage rejection	$V_{IN} = V_{OUT(NOM)} + 1\text{ V}$ $\pm V_{RIPPLE}$, $V_{RIPPLE} = 0.5\text{ V}$, $f = 120\text{ Hz}$		87		dB
		$V_{IN} = V_{OUT(NOM)} + 1\text{ V}$ $\pm V_{RIPPLE}$, $V_{RIPPLE} = 0.5\text{ V}$, $f = 1\text{ kHz}$		80		
		$V_{IN} = V_{OUT(NOM)} + 1\text{ V}$ $\pm V_{RIPPLE}$, $V_{RIPPLE} = 0.5\text{ V}$, $f = 100\text{ kHz}$		65		
I_Q	Quiescent current	$I_{OUT} = 0\text{ mA}$ to 1.2 A , $-40\text{ °C} < T_J < 125\text{ °C}$		250	500	μA
I_{SC}	Output current		1.5	2		A
T_{SHDN}	Thermal shutdown			175		$^{\circ}\text{C}$
	Hysteresis			25		

Notes:

⁽¹⁾ $V_{IN} = V_{OUT} + 1\text{ V}$ or 2.6 V , whichever is greater.

⁽²⁾Dropout voltage is the input-to-output voltage difference at which the output voltage is 100 mV below its nominal value; this specification does not apply for nominal output voltages below 2.5 V.

6 Application information

6.1 Thermal and short-circuit protections

The LDL1117 is self-protected from short-circuit conditions and overtemperature. When the output load is higher than the one supported by the device, the output current rises until the limit of typically 2 A is reached. The current limit value is dependent of the dissipated power, thanks to an additional SOA protection, so that the maximum power is limited.

The peak current available for a defined drop voltage ($V_{IN}-V_{OUT}$) is shown in [Section 7: "Typical performance characteristics"](#).

The thermal protection occurs when the junction temperature reaches typically 175 °C.

The IC enters the shutdown status. As soon as the junction temperature falls again below 150 °C (typ.) the device starts working again.

In order to calculate the maximum power that the device can dissipate, keeping the junction temperature below T_{J-OP} , the following formula is used:

Equation 1

$$P_{DMAX} = (125 - T_{AMB}) / R_{THJ-A}$$

P_{DMAX} should be also derated according to the maximum current allowed by the SOA protection.

6.2 Input and output capacitor selection

The LDL1117 requires external capacitors to assure the regulator control loop stability.

Any good quality ceramic capacitor can be used but, the X5R and the X7R are suggested since they guarantee a very stable combination of capacitance and ESR over the temperature range. The input/output capacitors should be placed as close as possible to the relative pins. The LDL1117 requires an input capacitor with a minimum value of 1 μ F.

This capacitor must be placed as close as possible to the input pin of the device and returned to a clean analog ground. The control loop of the LDL1117 is designed to work with an output ceramic capacitor. Other type of capacitors may be used, as long as they meet the requirements of minimum capacitance and equivalent series resistance (ESR), as shown in [Figure 20: "Stability plan \(VOUT = 5 V\)"](#) and [Figure 21: "Stability plan \(VOUT = 1.2 V\)"](#).

To assure stability, the output capacitor must maintain its ESR and capacitance in the stable region, over the full operating temperature range.

The suggested combination of 1 μ F input and 4.7 μ F output capacitors offers a good compromise among the stability of the regulator, optimum transient response and total PCB area occupation.

7 Typical performance characteristics

(The following plots are referred to the typical application circuit and, unless otherwise noted, at $T_A = 25\text{ }^\circ\text{C}$)

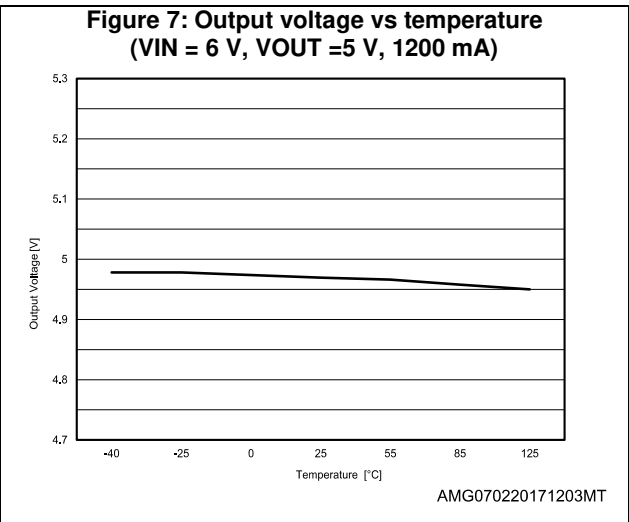
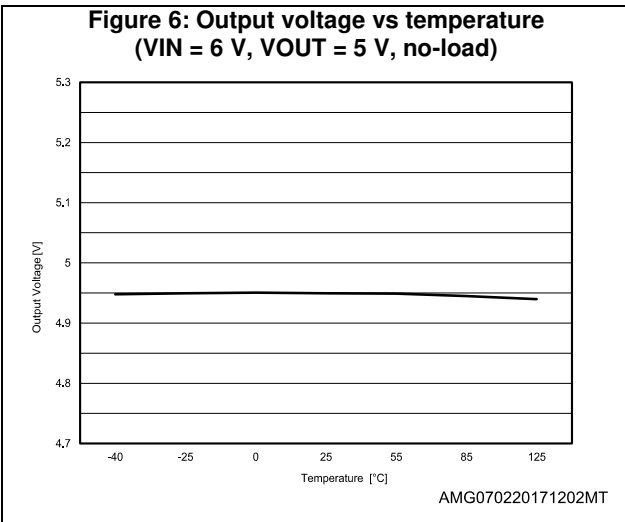
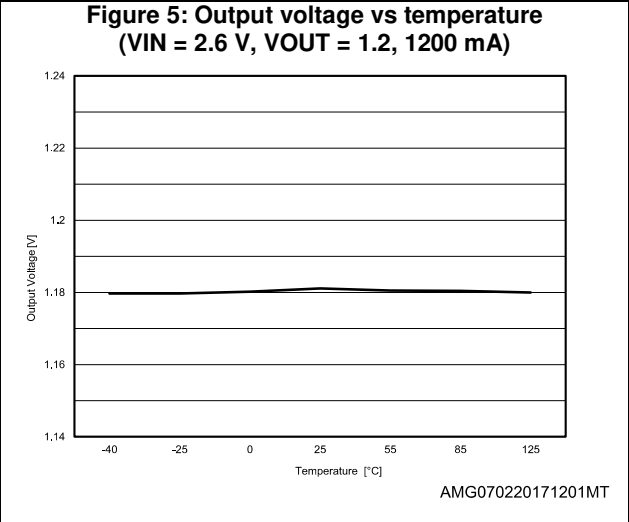
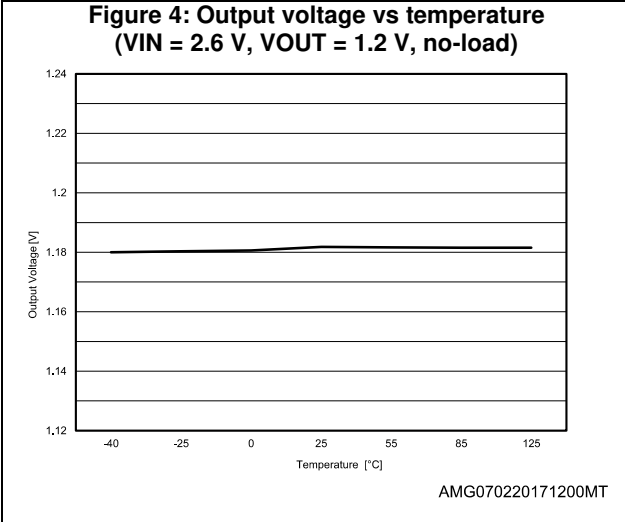

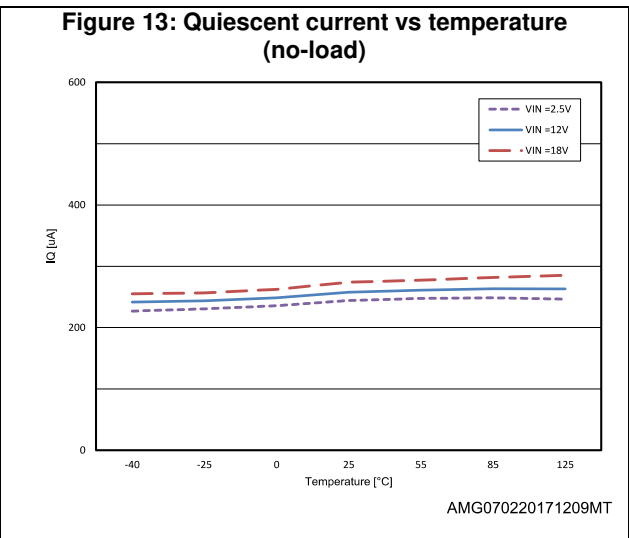
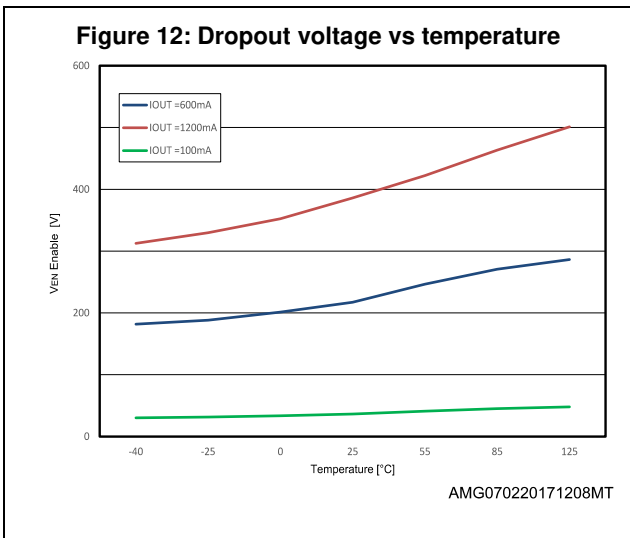
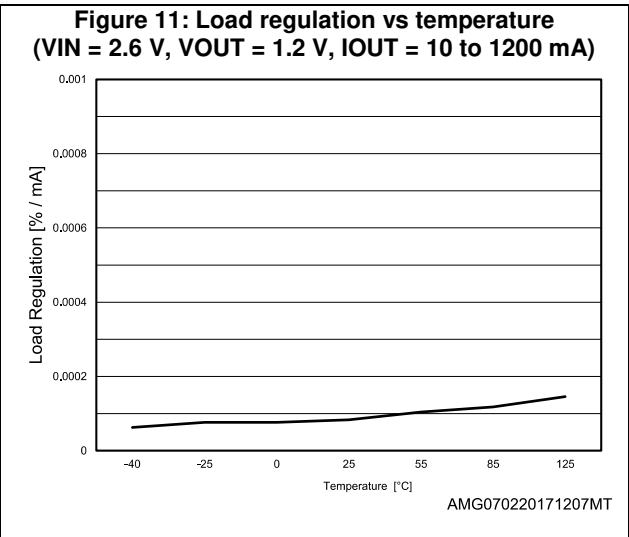
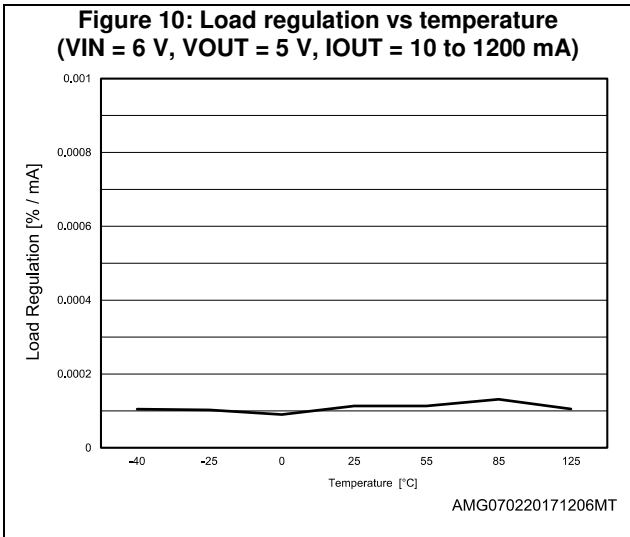
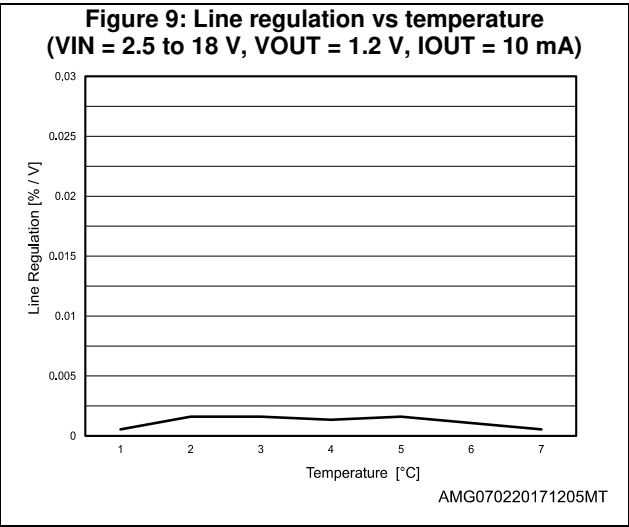
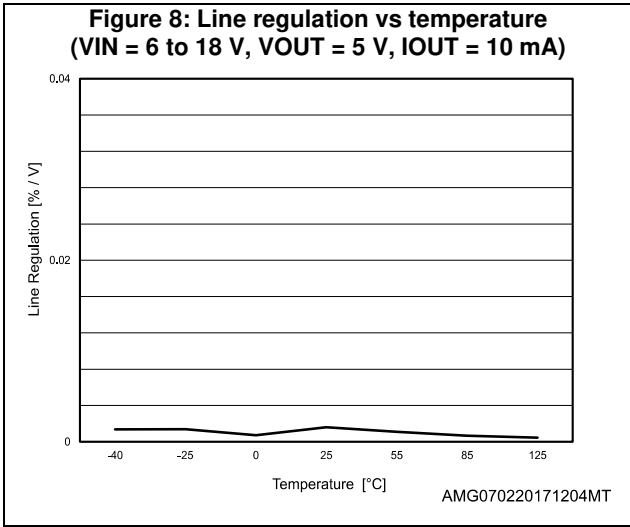

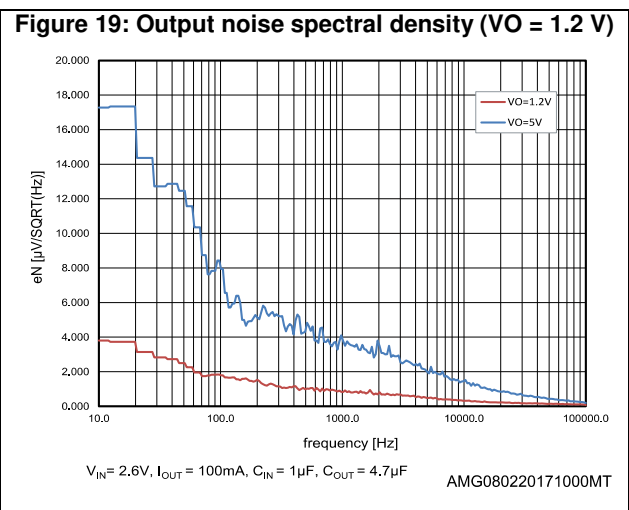
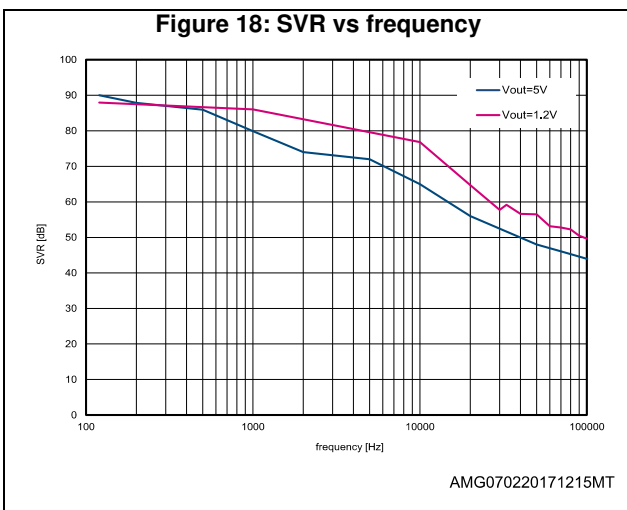
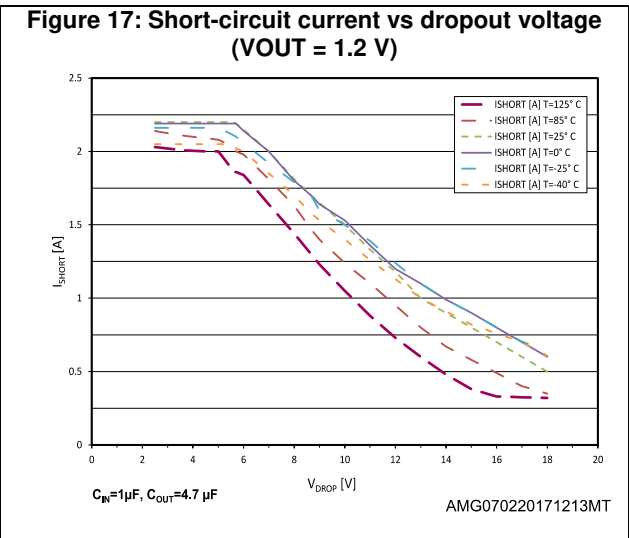
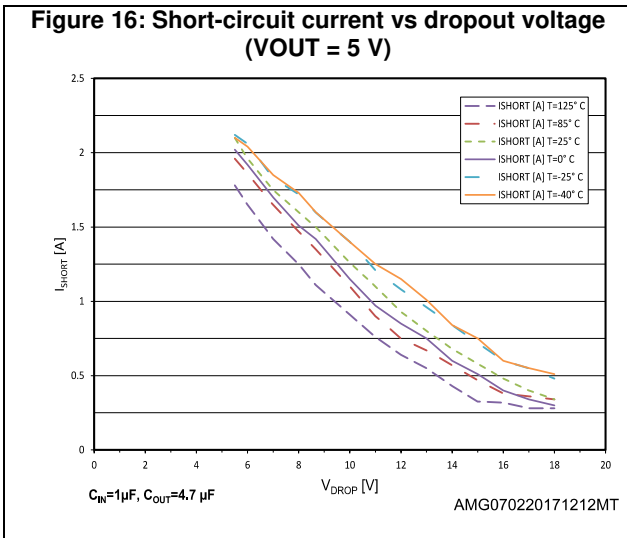
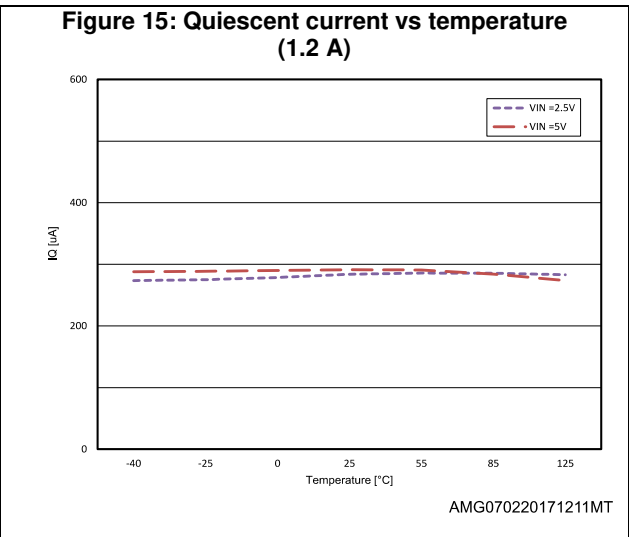
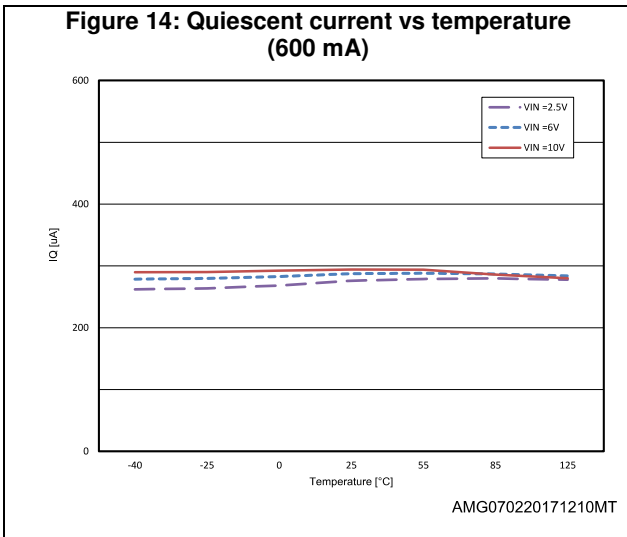

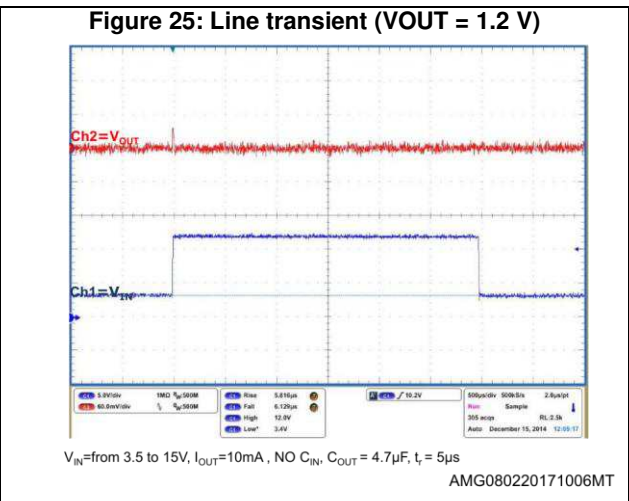
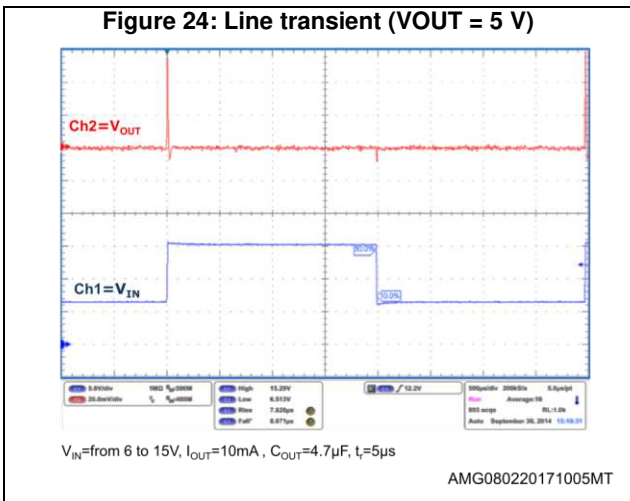
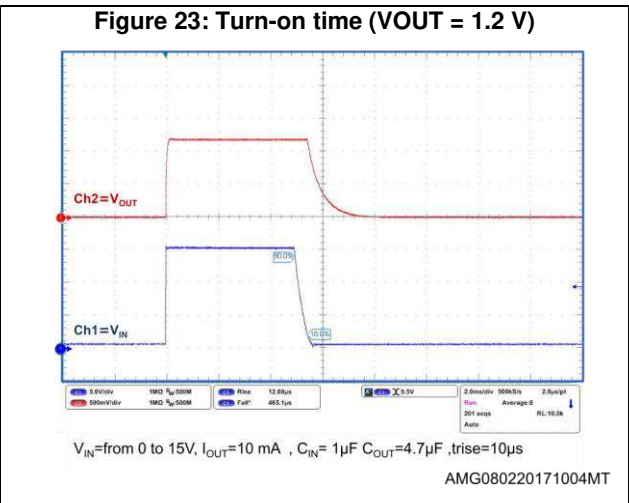
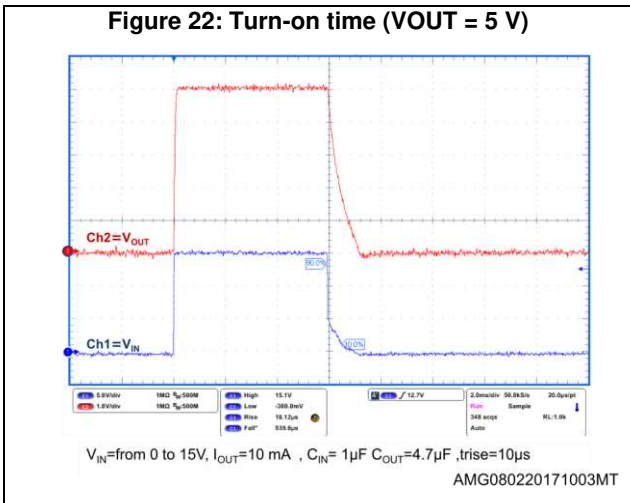
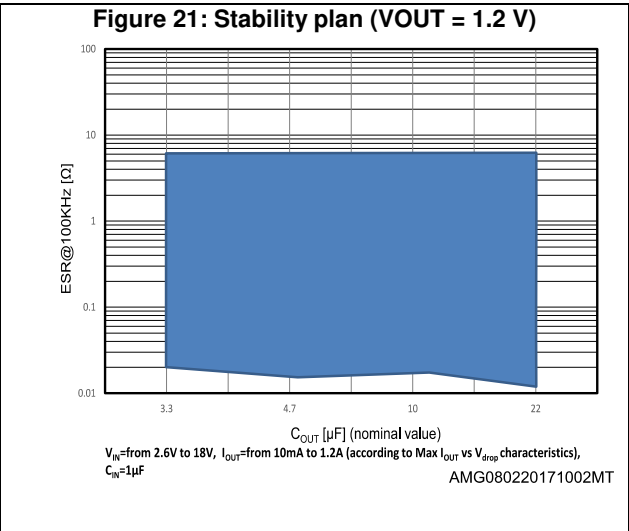
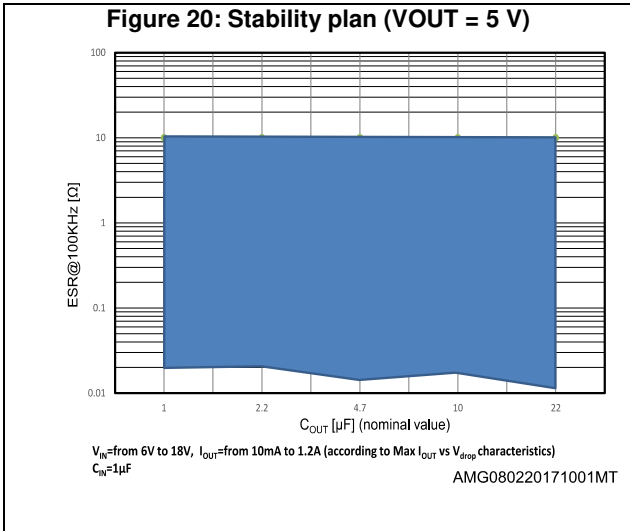
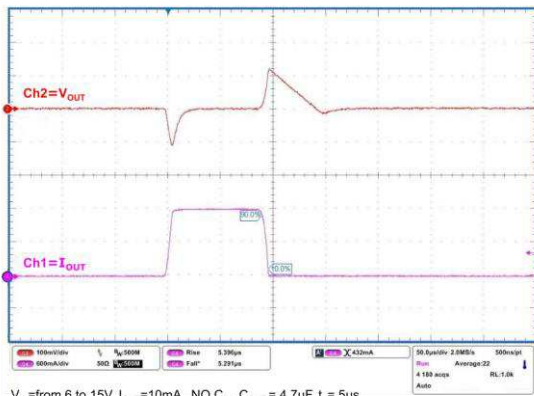

Figure 26: Load transient (VOUT = 1.2 V)



V_{IN} =from 6 to 15V, I_{OUT} =10mA, NO C_{IN} , C_{OUT} = 4.7µF, t_r = 5µs

AMG080220171007MT

Figure 27: Load transient (VOUT = 5 V)

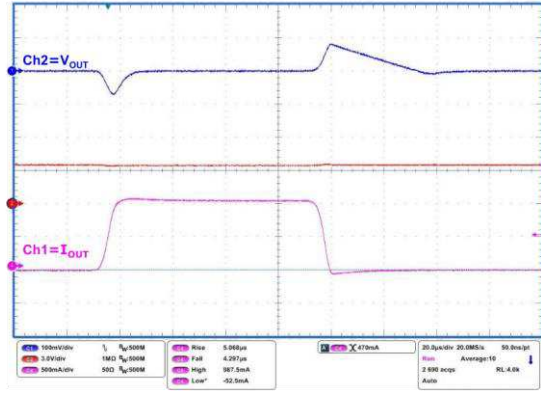

V_{IN} =3.5V, I_{OUT} =from 10mA to 1.2A, C_{IN} =1µF C_{OUT} =4.7µF Trise=5µs

AMG130220171300MT

8 Package information

In order to meet environmental requirements, ST offers these devices in different grades of ECOPACK® packages, depending on their level of environmental compliance. ECOPACK® specifications, grade definitions and product status are available at: www.st.com. ECOPACK® is an ST trademark.

8.1 SOT223 package information

Figure 28: SOT223 package outline

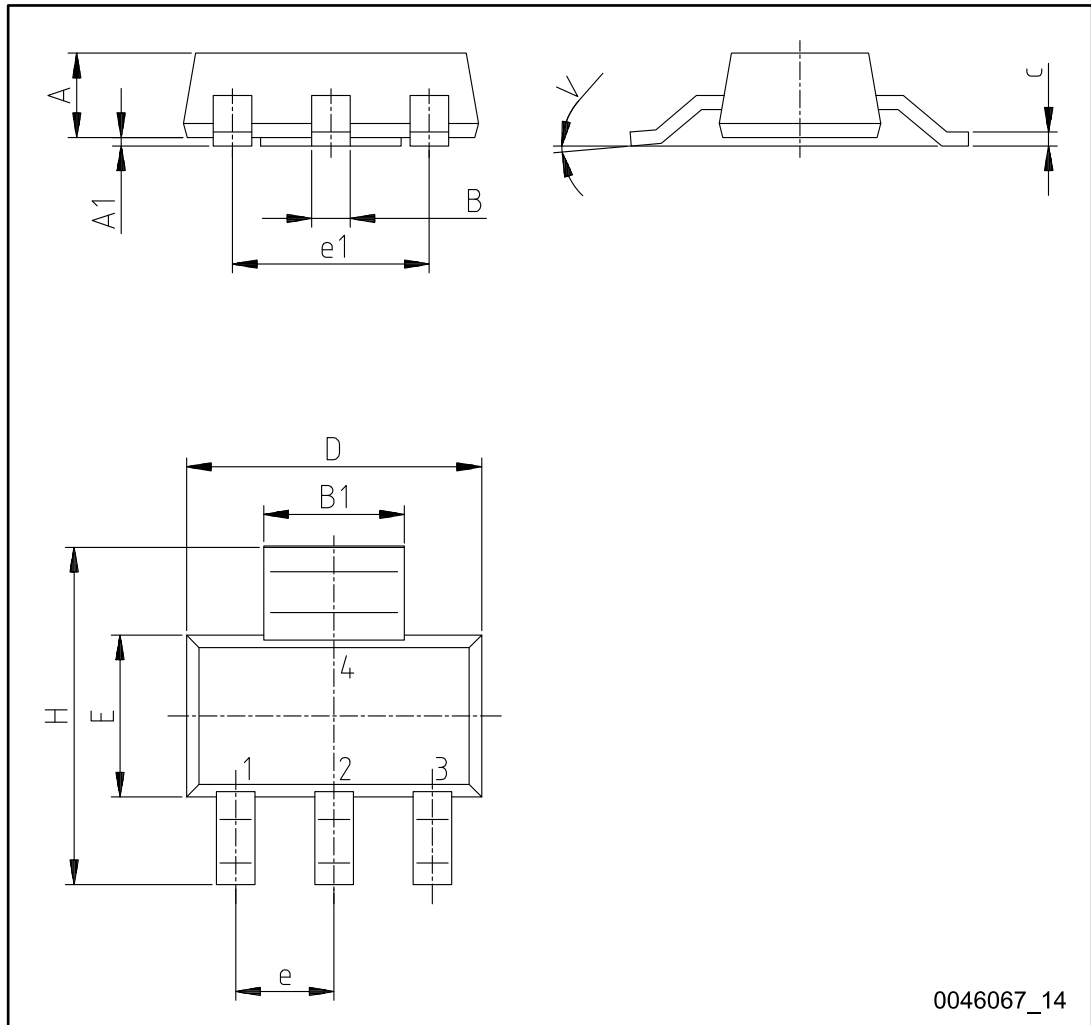

0046067_14

Table 5: SOT223 package mechanical data

Dim.	mm		
	Min.	Typ.	Max.
A			1.8
A1	0.02		0.1
B	0.6	0.7	0.85
B1	2.9	3	3.15
c	0.24	0.26	0.35
D	6.3	6.5	6.7
e		2.3	
e1		4.6	
E	3.3	3.5	3.7
H	6.7	7.0	7.3
V			10°

9 Ordering information

Table 6: Order code

Part number	Marking	Order code	Output voltage (V)
LDL1117	LL12	LDL1117S12R	1.185
	LL15	LDL1117S15R	1.5
	LL18	LDL1117S18R	1.8
	LL25	LDL1117S25R	2.5
	LL30	LDL1117S30R	3.0
	LL33	LDL1117S33R	3.3
	LL50	LDL1117S50R	5.0

10 Revision history

Table 7: Document revision history

Date	Revision	Changes
27-Feb-2017	1	Initial release.
30-Mar-2017	2	Updated features in cover page and <i>Section 9: "Ordering information"</i> . Minor text changes.
04-Jul-2017	3	In <i>Table 3: "Thermal data"</i> : - thermal data values changed Minor text changes.

IMPORTANT NOTICE – PLEASE READ CAREFULLY

STMicroelectronics NV and its subsidiaries ("ST") reserve the right to make changes, corrections, enhancements, modifications, and improvements to ST products and/or to this document at any time without notice. Purchasers should obtain the latest relevant information on ST products before placing orders. ST products are sold pursuant to ST's terms and conditions of sale in place at the time of order acknowledgement.

Purchasers are solely responsible for the choice, selection, and use of ST products and ST assumes no liability for application assistance or the design of Purchasers' products.

No license, express or implied, to any intellectual property right is granted by ST herein.

Resale of ST products with provisions different from the information set forth herein shall void any warranty granted by ST for such product.

ST and the ST logo are trademarks of ST. All other product or service names are the property of their respective owners.

Information in this document supersedes and replaces information previously supplied in any prior versions of this document.

© 2017 STMicroelectronics – All rights reserved