



Chipsmall Limited consists of a professional team with an average of over 10 year of expertise in the distribution of electronic components. Based in Hongkong, we have already established firm and mutual-benefit business relationships with customers from,Europe,America and south Asia,supplying obsolete and hard-to-find components to meet their specific needs.

With the principle of "Quality Parts,Customers Priority,Honest Operation,and Considerate Service",our business mainly focus on the distribution of electronic components. Line cards we deal with include Microchip,ALPS,ROHM,Xilinx,Pulse,ON,Everlight and Freescale. Main products comprise IC,Modules,Potentiometer,IC Socket,Relay,Connector.Our parts cover such applications as commercial,industrial, and automotives areas.

We are looking forward to setting up business relationship with you and hope to provide you with the best service and solution. Let us make a better world for our industry!



Contact us

Tel: +86-755-8981 8866 Fax: +86-755-8427 6832

Email & Skype: info@chipsmall.com Web: www.chipsmall.com

Address: A1208, Overseas Decoration Building, #122 Zhenhua RD., Futian, Shenzhen, China



250 mA ultra low noise LDO

Datasheet - production data

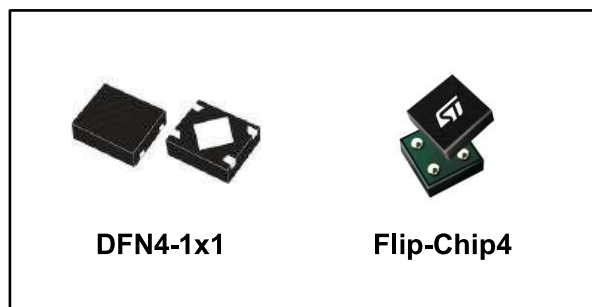

Features

- Ultra low output noise: 6.5 μV_{RMS}
- Operating input voltage range: 1.5 V to 5.5 V
- Output current up to 250 mA
- Very low quiescent current: 12 μA at no-load
- Controlled I_q in dropout condition
- Very low-dropout voltage: 250 mV at 250 mA
- Very high PSRR: 80 dB@100 Hz, 60 dB@100 kHz
- Output voltage accuracy: 2% across line, load and temperature
- Output voltage versions: from 1 V to 5 V, with 50 mV step
- Logic-controlled electronic shutdown
- Output discharge feature
- Internal soft-start
- Overcurrent and thermal protections
- Temperature range: from -40 °C to +125 °C
- Packages: Flip-Chip4, DFN4-1x1

Applications

- Smartphones/tablets
- Image sensors
- Instrumentation
- VCO and RF modules

Description

The LDLN025 is a 250 mA low-dropout voltage regulator, able to work with an input voltage range from 1.5 V to 5.5 V.

The typical dropout voltage at 250 mA load is 120 mV.

The very low quiescent current, which is just 12 μA at no-load, extends battery-life of applications requiring very long standby time.

Thanks to its ultra low noise value and high PSRR, the LDLN025 provides a very clean output, suitable for ultra-sensitive loads. It is stable with ceramic capacitors.

The enable logic control function puts the device into shutdown mode allowing a total current consumption lower than 1 μA .

The device also includes short-circuit and thermal protection.

Typical applications are noise sensitive loads such as ADC, VCO in mobile phones and tablets, wireless LAN devices. The LDLN025 is designed to keep the quiescent current under control and at a low value also during dropout operation, extending the operating time of battery-powered devices.

Several small package options are available.

Contents

1	Block diagram.....	3
2	Pin configuration	4
3	Typical application diagram	5
4	Maximum ratings	6
5	Electrical characteristics	7
6	Typical characteristics	9
7	Package information	14
	7.1 Flip-Chip4 package information.....	15
	7.2 Flip-Chip4 packing information.....	17
	7.3 DFN4-1x1 package information.....	18
	7.4 DFN4-1x1 packing information.....	19
8	Ordering information.....	20
	8.1 Marking information.....	20
9	Revision history	21

1 Block diagram

Figure 1: Block diagram

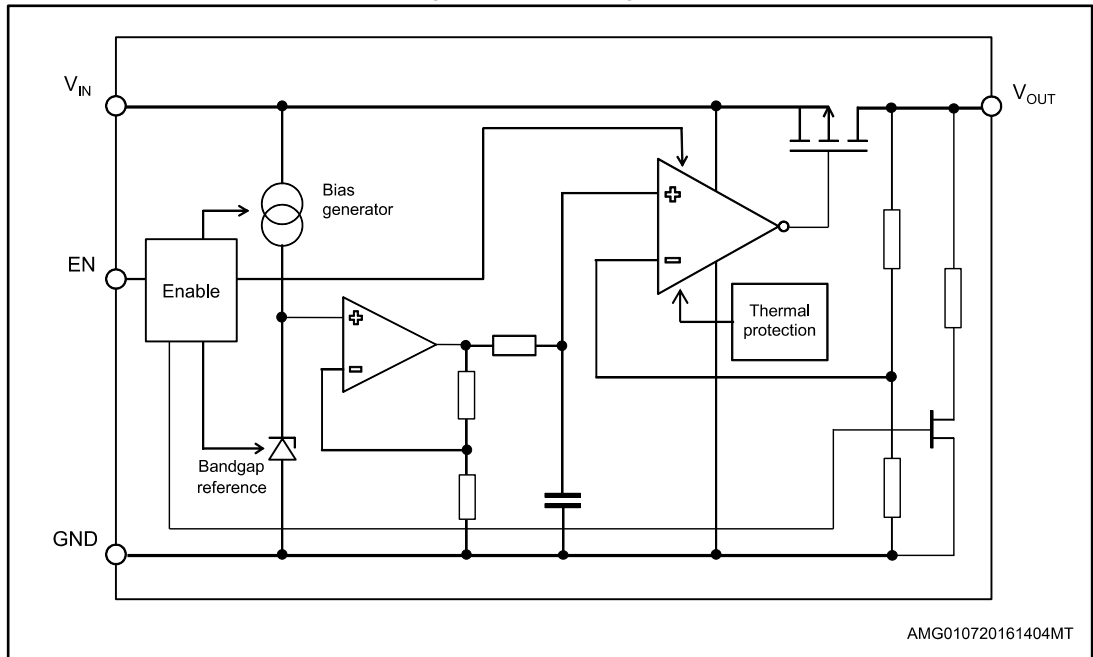

2 Pin configuration

Figure 2: Pin configuration

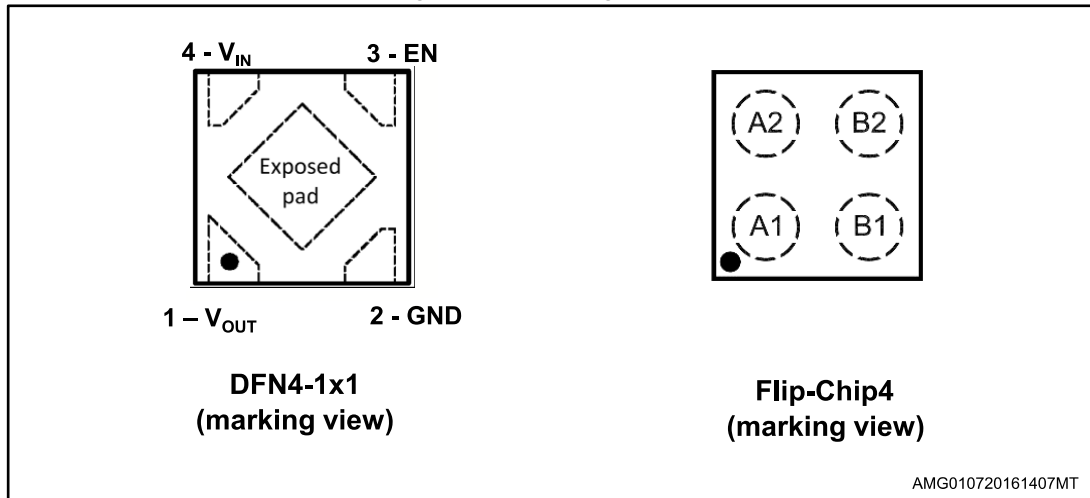
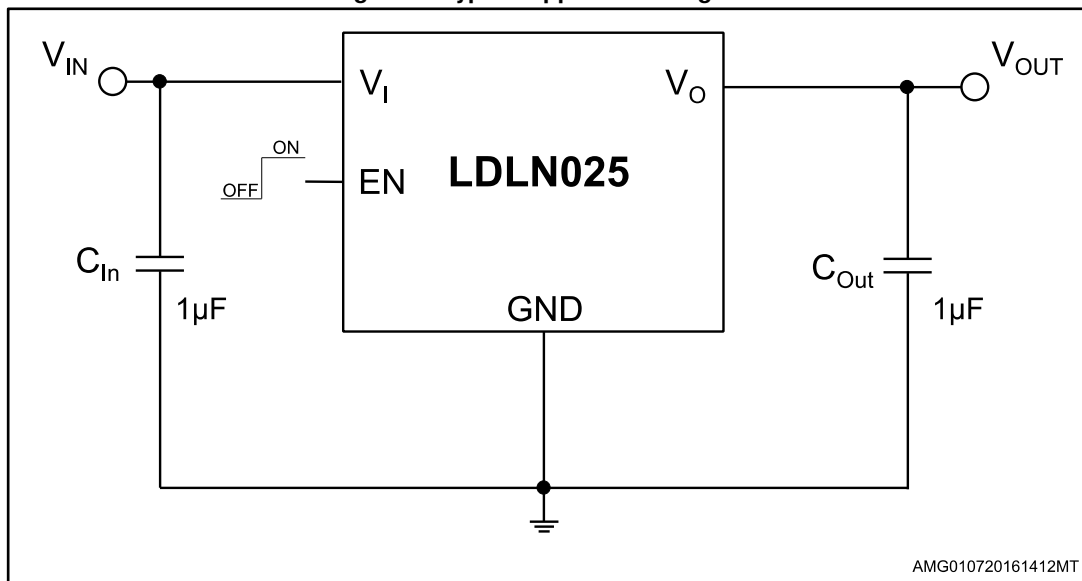

Table 1: Pin description

Symbol	DFN4-1x1	Flip-Chip4	Description
V _{IN}	4	A1	LDO Supply voltage
V _{OUT}	1	A2	LDO Output voltage
GND	2	B2	Ground
EN	3	B1	Enable input: set V _{EN} = high to turn on the device; V _{EN} = low to turn off the device
NC	-	-	This pin is internally pulled down via 1 MΩ resistor
Exposed pad	Exposed pad	-	Not internally connected: can be connected to GND
			Must be connected to GND

3 Typical application diagram

Figure 3: Typical application diagram



4 Maximum ratings

Table 2: Absolute maximum ratings

Symbol	Parameter	Value	Unit
V _{IN}	Input supply voltage	-0.3 to 7	V
V _{OUT}	Output voltage	-0.3 to V _{IN} +0.3	V
I _{OUT}	Output current	Internally limited	A
EN	Enable pin voltage	-0.3 to V _{IN} +0.3	V
P _D	Power dissipation	Internally limited	W
ESD	Charge device model	±1000	V
	Human body model	±2000	
T _{J-OP}	Operating junction temperature	-40 to 125	°C
T _{J-MAX}	Maximum junction temperature	150	°C
T _{STG}	Storage temperature	-55 to 150	°C

Table 3: Thermal data

Symbol	Parameter	DFN4-1x1	Flip-Chip4	Unit
R _{thja}	Thermal resistance, junction-to-ambient	220	210	°C/W

5 Electrical characteristics

($T_J = 25\text{ °C}$, $V_{IN} = V_{OUT(nom)} + 1\text{ V}$ or 1.5 V , whichever is greater; $V_{EN} = 1.2\text{ V}$; $C_{IN} = 1\text{ }\mu\text{F}$; $C_{OUT} = 1\text{ }\mu\text{F}$; $I_{OUT} = 1\text{ mA}$)

Table 4: Electrical characteristics

Symbol	Parameter	Test conditions	Min.	Typ.	Max.	Unit	
V_{IN}	Operating input voltage range		1.5		5.5	V	
V_{OUT}	Output voltage accuracy	$V_{OUT} + 1\text{ V}^{(1)} < V_{IN} < 5.5\text{ V}$, $1\text{ mA} < I_{OUT} < 0.25\text{ A}$, $V_{OUT} \geq 1.8\text{ V}$, $-40\text{ °C} < T_J < 125\text{ °C}$	-2.0		2.0	%	
		$V_{OUT} + 1\text{ V}^{(1)} < V_{IN} < 5.5\text{ V}$, $1\text{ mA} < I_{OUT} < 0.25\text{ A}$, $V_{OUT} < 1.8\text{ V}$, $-40\text{ °C} < T_J < 125\text{ °C}$	-3.0		+3.0		
$\Delta V_{OUT}/\Delta V_{IN}$	Static line regulation	$V_{OUT} + 1\text{ V}^{(1)} < V_{IN} < 5.5\text{ V}$ $-40\text{ °C} < T_J < 125\text{ °C}$		0.02		%V	
	Line transient ⁽²⁾	$\Delta V_{IN} = \pm 0.6\text{ V}$, $t_{rise} = t_{fall} = 30\text{ }\mu\text{s}$	-1		+1		mV
$\Delta V_{OUT}/\Delta I_{OUT}$	Static load regulation	$1\text{ mA} < I_{OUT} < 0.25\text{ A}$ $-40\text{ °C} < T_J < 125\text{ °C}$		0.002		%/mA	
	Load transient ⁽²⁾	$\Delta I_{OUT} = 1\text{ mA}$ to 250 mA and back, $t_{rise} = t_{fall} = 10\text{ }\mu\text{s}$	-40		+40		mV
ΔV_{OUT}	Overshoot on startup ⁽²⁾	Percentage of $V_{OUT(nom)}$			5	%	
V_{DROP}	Dropout voltage ⁽³⁾	$I_{OUT} = 0.1\text{ A}$		50		mV	
		$I_{OUT} = 0.25\text{ A}$		120			
		$I_{OUT} = 0.25\text{ A}$, $-40\text{ °C} < T_J < 125\text{ °C}$ (Flip-Chip4)			200		
		$I_{OUT} = 0.25\text{ A}$, $-40\text{ °C} < T_J < 125\text{ °C}$ (DFN4-1x1)			250		
eN	Output noise voltage ⁽²⁾	$f = 10\text{ Hz}$ to 100 kHz ; $I_{OUT} = 1\text{ mA}$		10		μV_{RMS}	
		$f = 10\text{ Hz}$ to 100 kHz ; $I_{OUT} = 250\text{ mA}$		6.5			
SVR	Supply voltage rejection ⁽²⁾	$f = 100\text{ Hz}$; $I_{OUT} = 20\text{ mA}$		80		dB	
		$f = 1\text{ kHz}$; $I_{OUT} = 20\text{ mA}$		80			
		$f = 10\text{ kHz}$; $I_{OUT} = 20\text{ mA}$		75			
		$f = 100\text{ kHz}$; $I_{OUT} = 20\text{ mA}$		60			

Symbol	Parameter	Test conditions	Min.	Typ.	Max.	Unit
I _Q	Quiescent current ⁽⁴⁾	I _{OUT} = 0 A		12		μA
		I _{OUT} = 0 A; -40 °C < T _J < 125 °C			25	
	Shutdown current	I _{OUT} = 0.25 A		250		μA
		I _{OUT} = 0.25 A; -40 °C < T _J < 125 °C			425	
I _{SC}	Short-circuit current	V _{OUT} = 0 V	250	500		mA
R _{LOW}	Output discharge resistance	V _{EN} = 0 V		230		Ω
V _{EN}	V _{IL} , enable input logic low	V _{OUT} + 1 V ⁽¹⁾ < V _{IN} < 5.5 V -40 °C < T _J < 125 °C			0.4	V
	V _{IH} , enable input logic high		1.2			
I _{EN}	Enable pin input current	V _{IN} = V _{EN} = 5.5 V		5.5		μA
		V _{IN} = 5.5 V; V _{EN} = 0 V		0.001		
t _{ON}	Turn-on time ⁽²⁾	From V _{EN} > V _{IH} to V _{OUT} = 95 % of V _{OUT(nom)}		80	150	μs
T _{SHDN}	Thermal shutdown ⁽²⁾	I _{OUT} > 1 mA		160		°C
	Hysteresis			20		

Notes:

- (1) V_{IN} = V_{OUT} + 1 V or 1.5 V, whichever is greater. Not applicable for 5 V output voltage versions.
- (2) Guaranteed by design.
- (3) Dropout voltage is the input-to-output voltage difference at which the output voltage is 100 mV below its nominal value.
- (4) The quiescent current is defined as I_{IN-IOUT} and does not include the EN pin current.

Table 5: Recommended input and output capacitors

Symbol	Parameter	Test conditions	Min.	Typ.	Max.	Unit
C _{IN}	Input capacitance	Stability	0.7	1		μF
C _{OUT}	Output capacitance		0.7	1	10	
ESR	Output/input capacitance		5		500	mΩ

6 Typical characteristics

(The following plots are referred to LDLN025J2925R in the typical application circuit and, unless otherwise noted, at $T_A = 25\text{ }^\circ\text{C}$).

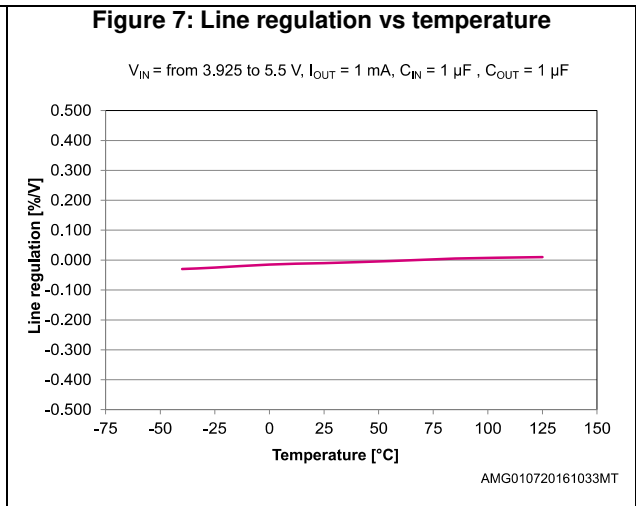
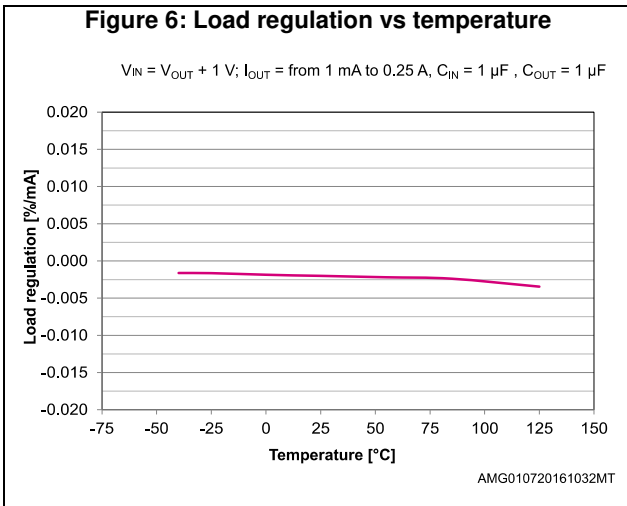
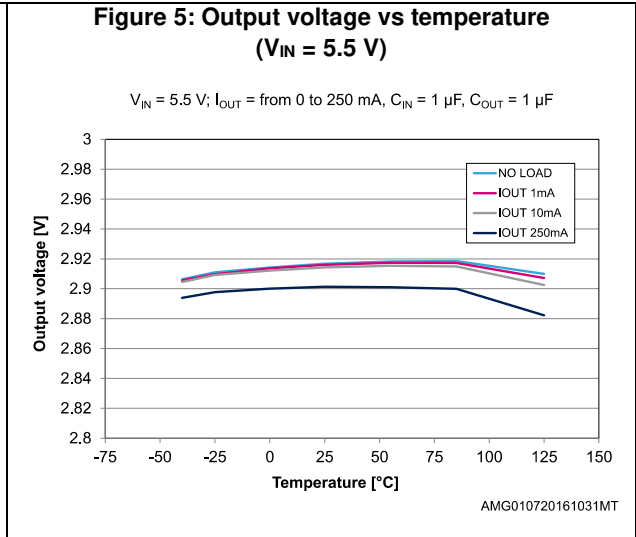
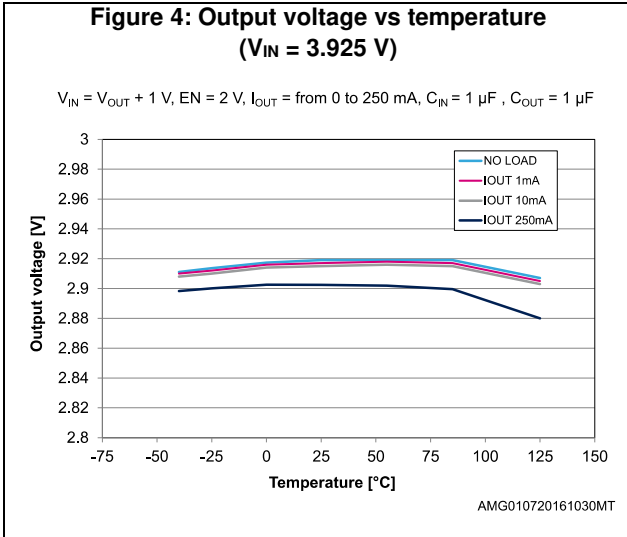

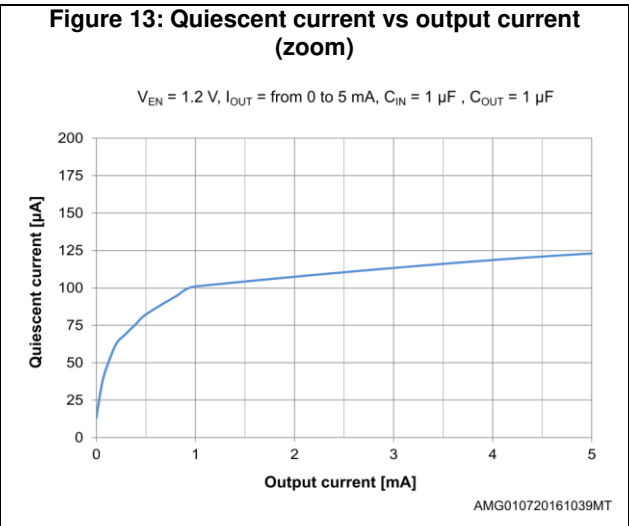
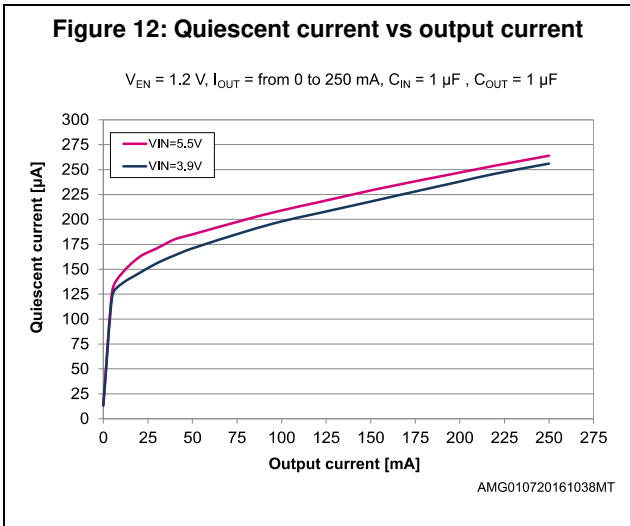
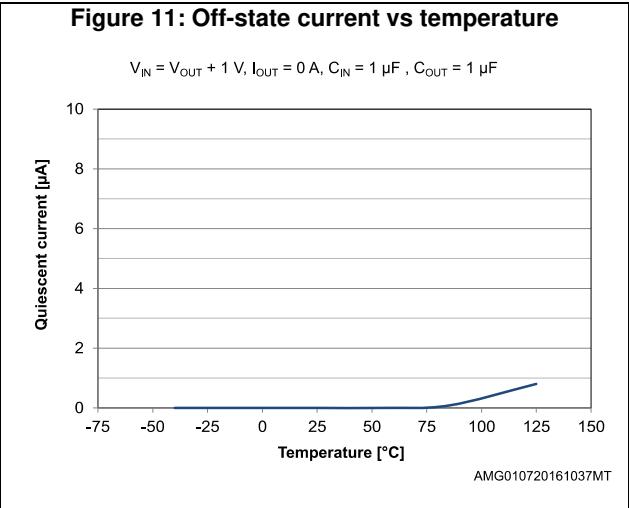
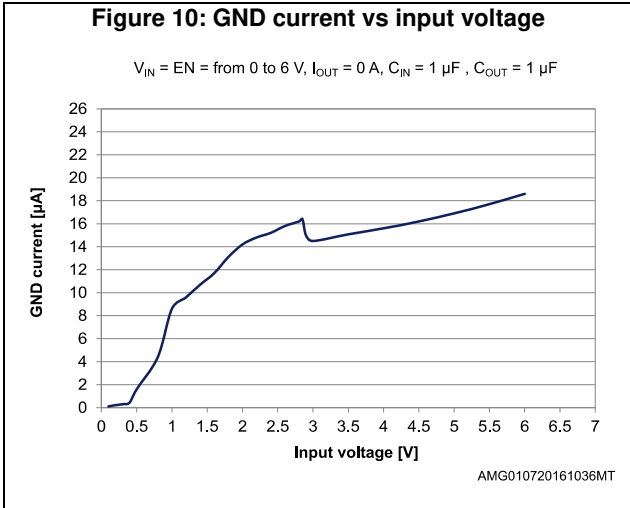
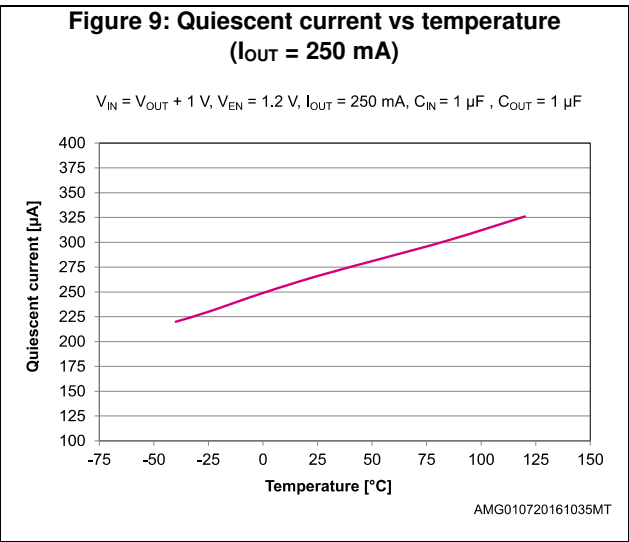
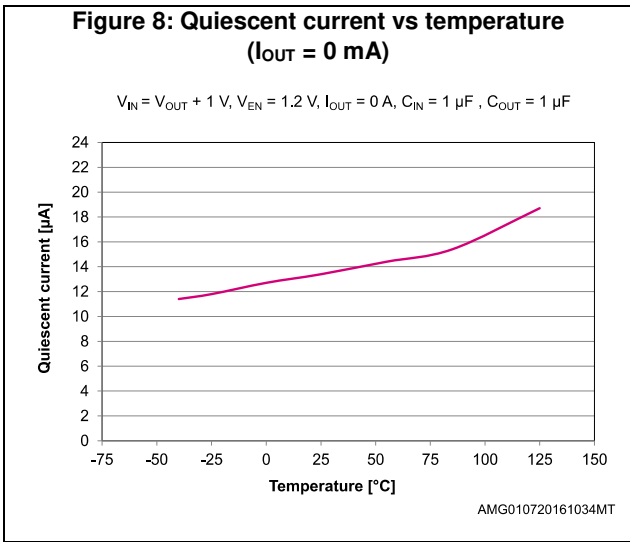

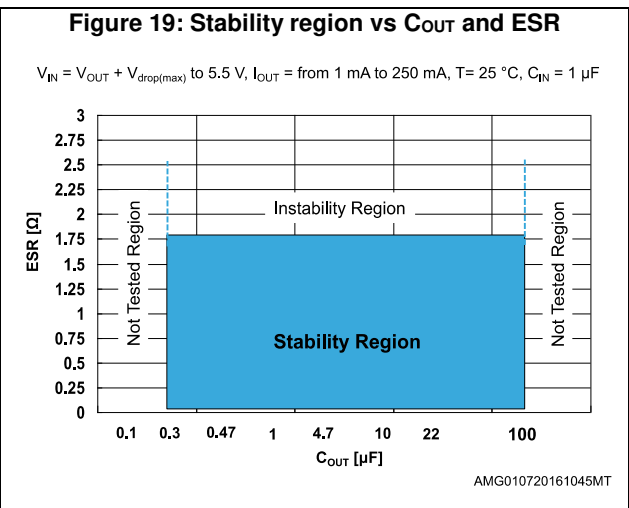
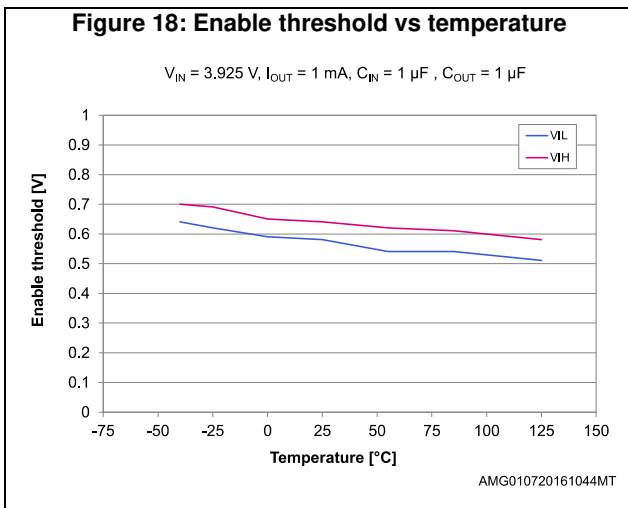
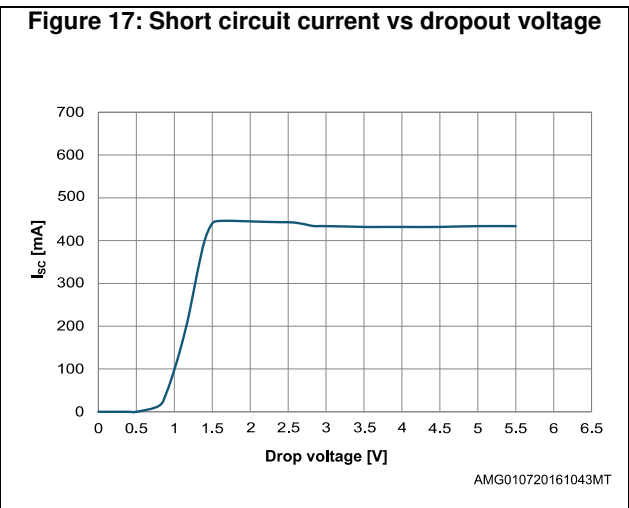
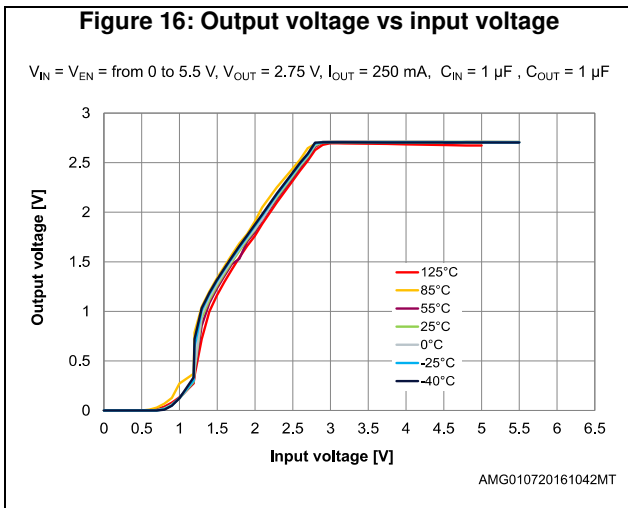
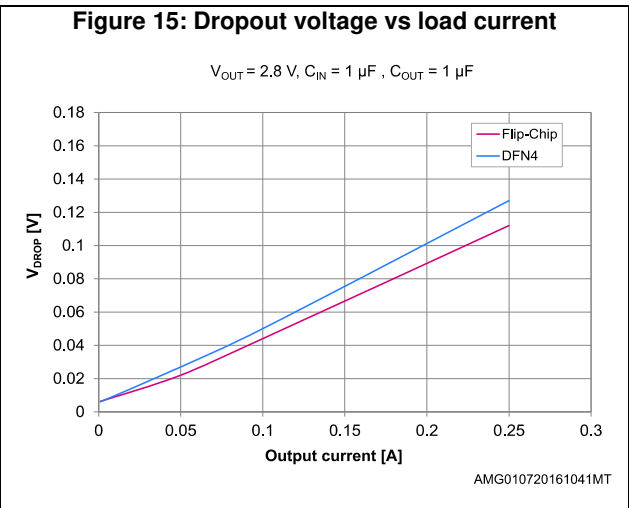
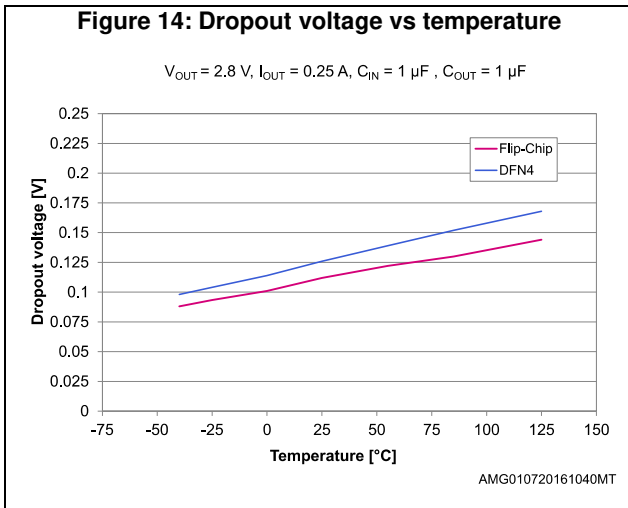

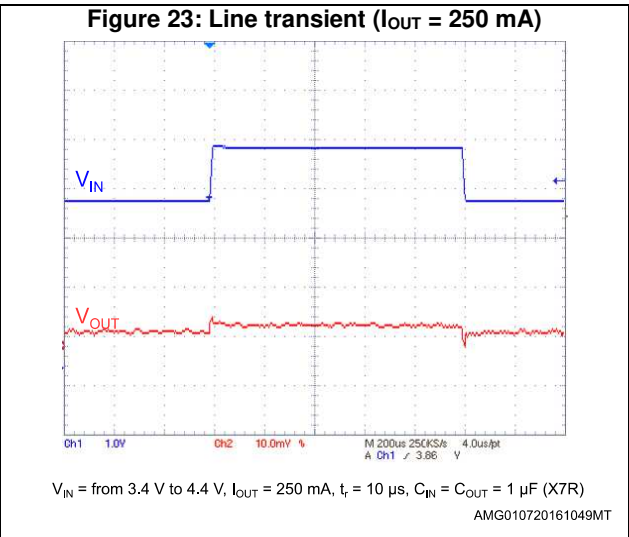
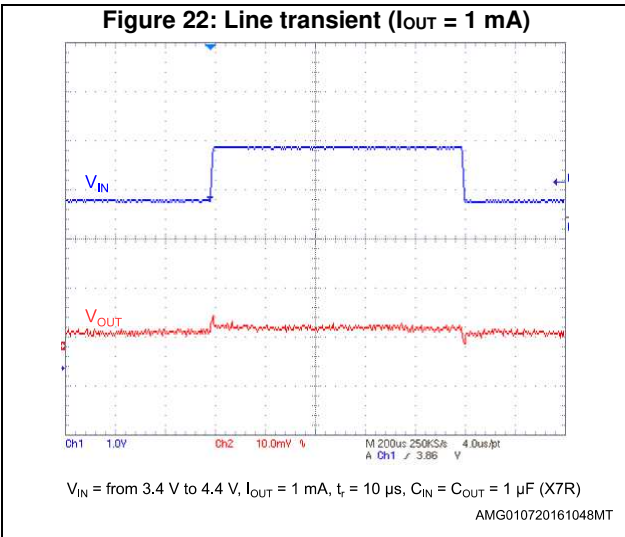
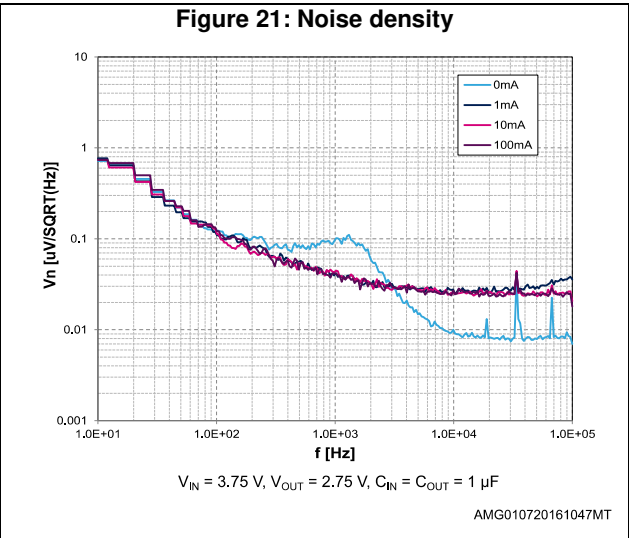
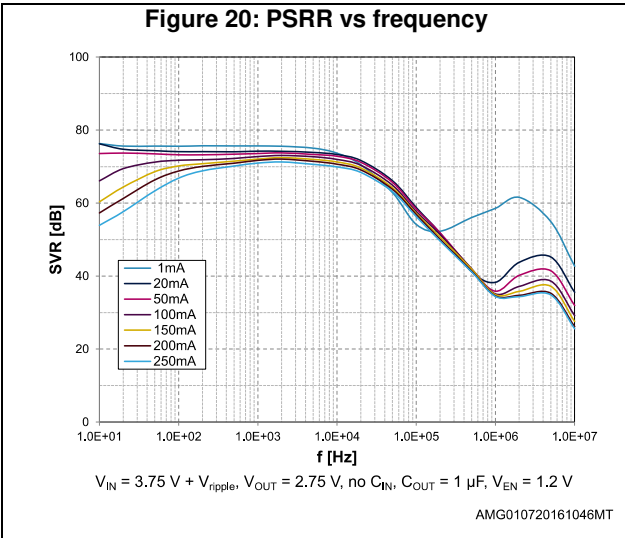
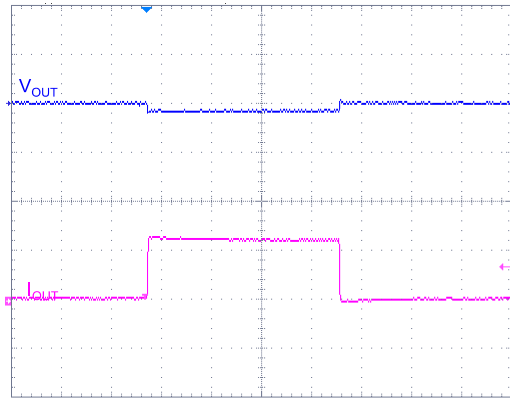

Figure 24: Load transient



I_{OUT} = from 0 mA to 250 mA, t_r = 10 μ s, C_{IN} = C_{OUT} = 1 μ F (X7R)

AMG010720161050MT

Figure 25: Inrush current

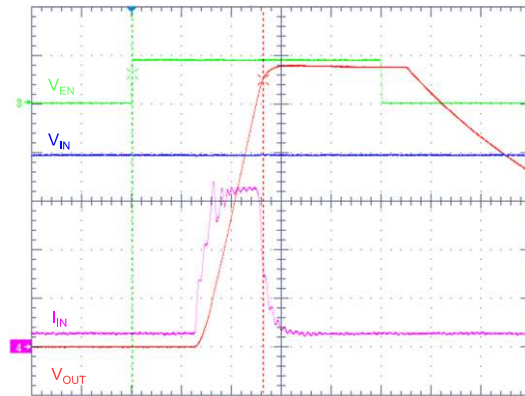

V_{IN} = 4 V, I_{OUT} = 0 mA, C_{IN} = C_{OUT} = 1 μ F (X7R)

AMG180720161000MT

Figure 26: Enable transient (I_{OUT} = 0 mA)

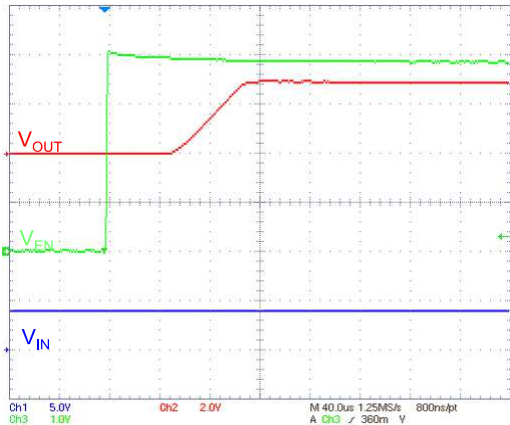

V_{IN} = 3.925 V, V_{EN} = from 0 V to 3.925 V, I_{OUT} = 0 mA, t_r = 1 μ s, C_{IN} = C_{OUT} = 1 μ F (X7R)

AMG010720161052MT

Figure 27: Enable transient (I_{OUT} = 250 mA)

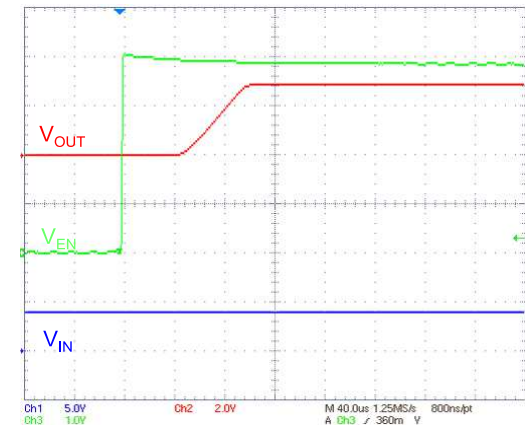

V_{IN} = 3.925 V, V_{EN} = from 0 V to 3.925 V, I_o = 250 mA, t_r = 1 μ s, C_{IN} = C_{OUT} = 1 μ F (X7R)

AMG010720161053MT

7 Package information

In order to meet environmental requirements, ST offers these devices in different grades of ECOPACK® packages, depending on their level of environmental compliance. ECOPACK® specifications, grade definitions and product status are available at: www.st.com. ECOPACK® is an ST trademark.

7.1 Flip-Chip4 package information

Figure 28: Flip-Chip4 package outline

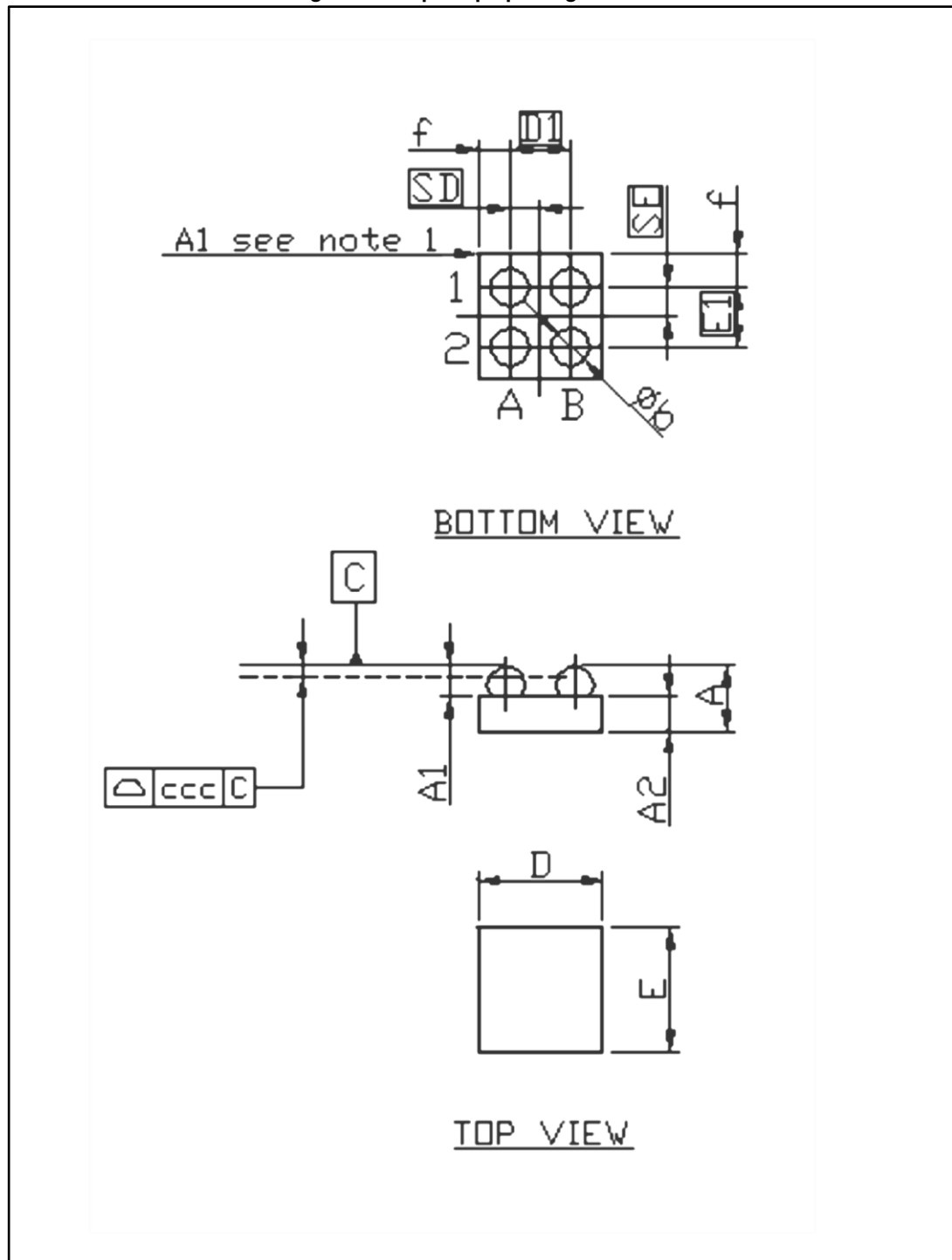
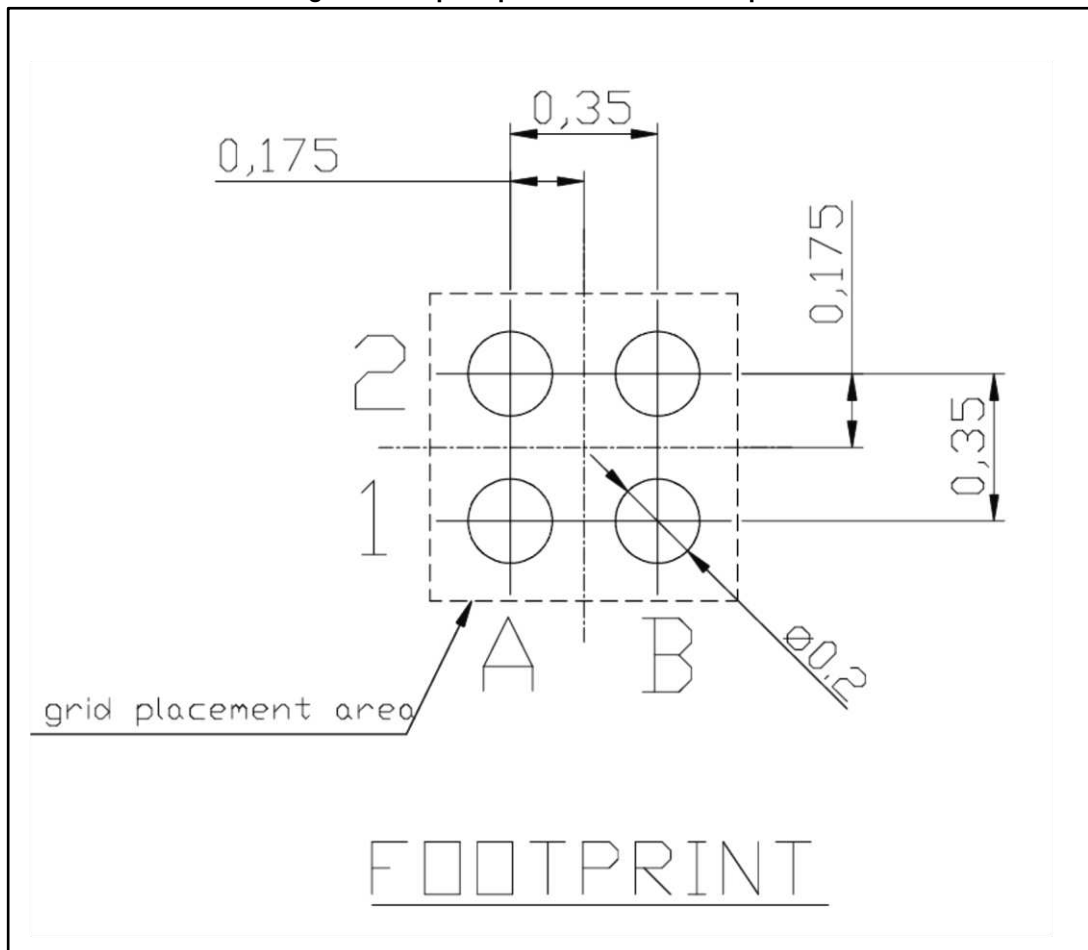

Table 6: Flip-Chip4 mechanical data

Dim.	mm		
	Min.	Typ.	Max.
A	0.375	0.410	0.445
A1	0.145	0.160	0.175
A2	0.230	0.250	0.270
b	0.189	0.210	0.231
D	0.598	0.628	0.658
D1		0.350	
E	0.598	0.628	0.658
E1		0.350	
SD		0.175	
SE		0.175	
f		0.139	
ccc		0.075	

Figure 29: Flip-Chip4 recommended footprint



7.3 DFN4-1x1 package information

Figure 31: DFN4-1x1 package outline

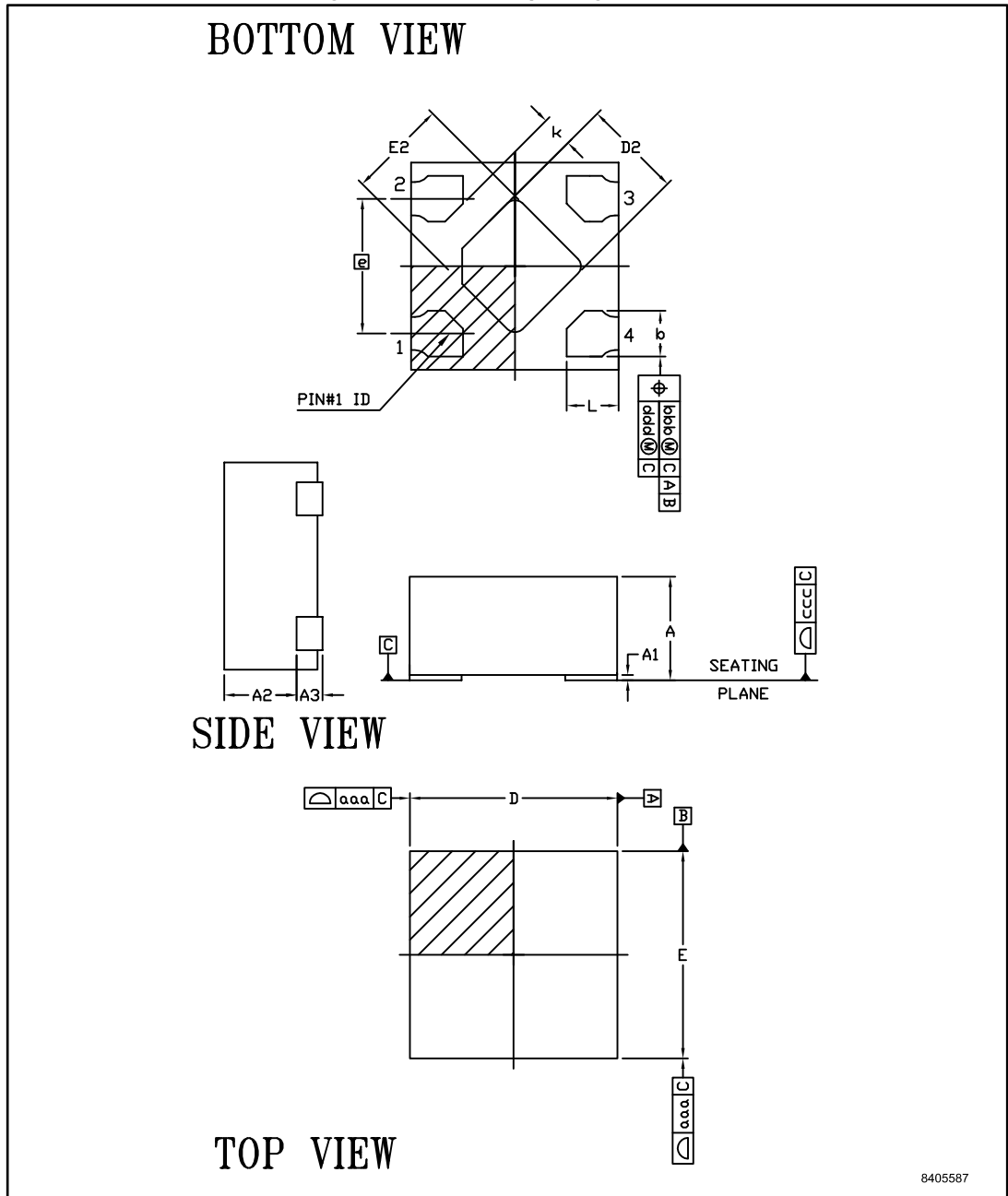
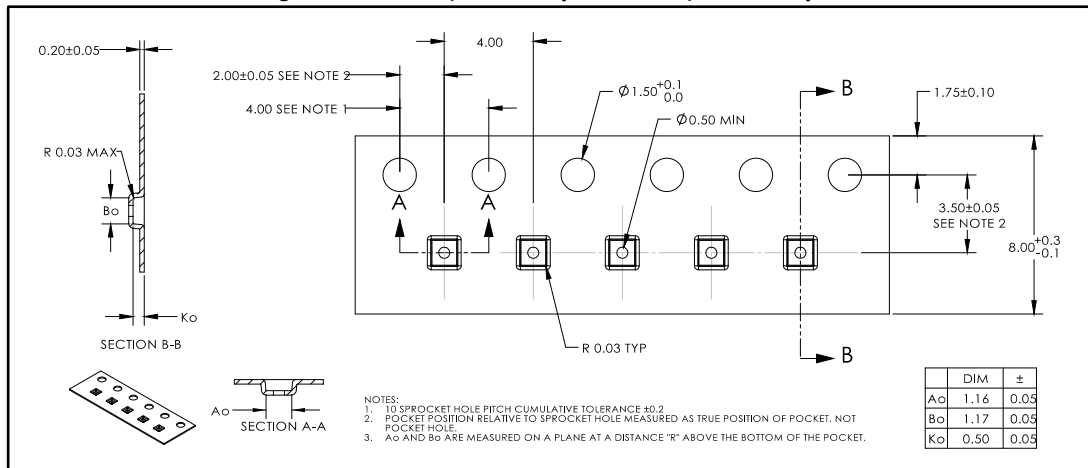

Table 7: DFN4-1x1 package mechanical data

Dim.	mm		
	Min.	Typ.	Max.
A	0.36		0.40
A1	0.00		0.05
A2	0.15	0.25	0.35
A3		0.125	
b	0.15	0.20	0.25
D	0.95	1.00	1.05
D2	0.38	0.48	0.58
e		0.65	
E	0.95	1.00	1.05
E2	0.38	0.48	0.58
L	0.15	0.25	0.35
K		0.15	
N		4	

7.4 DFN4-1x1 packing information

Figure 32: DFN4 (1x1x0.38 pitch 4 mm) carrier tape



8 Ordering information

Table 8: Order code

Order code	Package	Output voltage	Marking	Packing
LDLN025PU18R	DFN4-1x1	1.8 V	18	Tape and reel
LDLN025PU25R		2.5 V	25	
LDLN025PU275R		2.75 V	2Z	
LDLN025PU28R		2.8 V	28	
LDLN025PU29R		2.9 V	29	
LDLN025PU30R		3.0 V	30	
LDLN025PU32R		3.2 V	32	
LDLN025PU33R		3.3 V	33	
LDLN025PU50R		5.0 V	50	
LDLN025J12R		Flip-Chip4	1.2 V	
LDLN025J18R	1.8 V		E	
LDLN025J25R	2.5 V		H	
LDLN025J28R	2.8 V		I	
LDLN025J2925R	2.925 V		K	
LDLN025J30R	3.0 V		G	
LDLN025J32R	3.2 V		N	
LDLN025J33R	3.3 V		F	
LDLN025J50R	5.0 V		P	

8.1 Marking information

Figure 33: Flip-Chip marking composition (marking view)

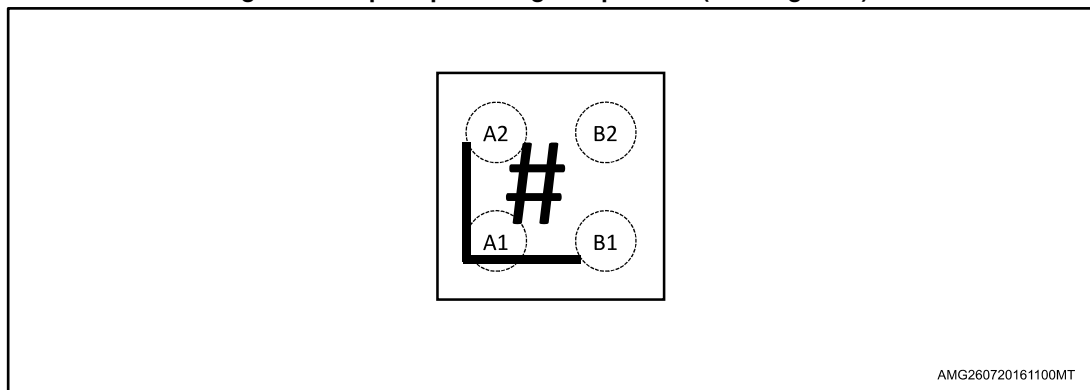

the symbol # indicates the marking digit, as per [Table 8: "Order code"](#).

9 Revision history

Table 9: Document revision history

Date	Revision	Changes
03-Aug-2016	1	First release.
01-Sep-2016	2	Updated <i>Table 8: "Order code"</i> . Minor text changes.
24-Oct-2016	3	Updated <i>Table 2: "Absolute maximum ratings"</i> . Minor text changes.
17-Nov-2016	4	Updated <i>Section 8: "Ordering information"</i> . Minor text changes.

IMPORTANT NOTICE – PLEASE READ CAREFULLY

STMicroelectronics NV and its subsidiaries ("ST") reserve the right to make changes, corrections, enhancements, modifications, and improvements to ST products and/or to this document at any time without notice. Purchasers should obtain the latest relevant information on ST products before placing orders. ST products are sold pursuant to ST's terms and conditions of sale in place at the time of order acknowledgement.

Purchasers are solely responsible for the choice, selection, and use of ST products and ST assumes no liability for application assistance or the design of Purchasers' products.

No license, express or implied, to any intellectual property right is granted by ST herein.

Resale of ST products with provisions different from the information set forth herein shall void any warranty granted by ST for such product.

ST and the ST logo are trademarks of ST. All other product or service names are the property of their respective owners.

Information in this document supersedes and replaces information previously supplied in any prior versions of this document.

© 2016 STMicroelectronics – All rights reserved