



Chipsmall Limited consists of a professional team with an average of over 10 year of expertise in the distribution of electronic components. Based in Hongkong, we have already established firm and mutual-benefit business relationships with customers from,Europe,America and south Asia,supplying obsolete and hard-to-find components to meet their specific needs.

With the principle of “Quality Parts,Customers Priority,Honest Operation,and Considerate Service”,our business mainly focus on the distribution of electronic components. Line cards we deal with include Microchip,ALPS,ROHM,Xilinx,Pulse,ON,Everlight and Freescale. Main products comprise IC,Modules,Potentiometer,IC Socket,Relay,Connector.Our parts cover such applications as commercial,industrial, and automotives areas.

We are looking forward to setting up business relationship with you and hope to provide you with the best service and solution. Let us make a better world for our industry!



## Contact us

Tel: +86-755-8981 8866 Fax: +86-755-8427 6832

Email & Skype: info@chipsmall.com Web: www.chipsmall.com

Address: A1208, Overseas Decoration Building, #122 Zhenhua RD., Futian, Shenzhen, China



**Description**

- Industry standard SMD crystal  
Resistance welded, hermetically sealed in an inert atmosphere, glass to metal seals on leads  
Lead wires are mounted onto a plastic former to create a gull wing mount
- Model HC49/4HSMX
- Model Issue number 17

**Frequency Parameters**

- Frequency 8.0MHz
- Frequency Tolerance  $\pm 30.00\text{ppm}$
- Tolerance Condition @ 25°C  $\pm 2^\circ\text{C}$
- Frequency Stability  $\pm 50.00\text{ppm}$
- Operating Temperature Range -10.00 to 60.00°C
- Overtone Order Fundamental
- Ageing  $\pm 5\text{ppm typ per year @ } 25^\circ\text{C}$

**Electrical Parameters**

- Load Capacitance (CL) 16.00pF
- Shunt Capacitance (C0) 7pF max
- Drive Level 500µW max
- ESR 40.00Ω max

**Environmental Parameters**

- Shock: 981m/s<sup>2</sup>, 6ms, 3 times in each of 3 mutually perpendicular planes
- Vibration: 10Hz-60Hz, 0.75mm amplitude, 60Hz-500Hz, 98.1m/s<sup>2</sup>, 30mins in 3 mutually perpendicular planes
- Storage Temperature Range: -55 to 125°C

**Compliance**

- RoHS Status (2011/65/EU) Compliant
- REACH Status Compliant
- MSL Rating (JDEC-STD-033): Not Applicable

**Packaging Details**

- Pack Style: Bulk Loose in bulk pack  
Pack Size: 100
- *Alternative packing option available*

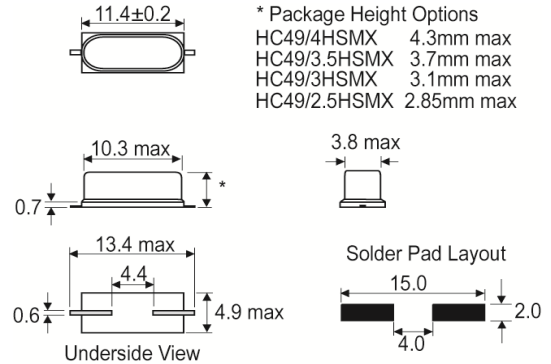
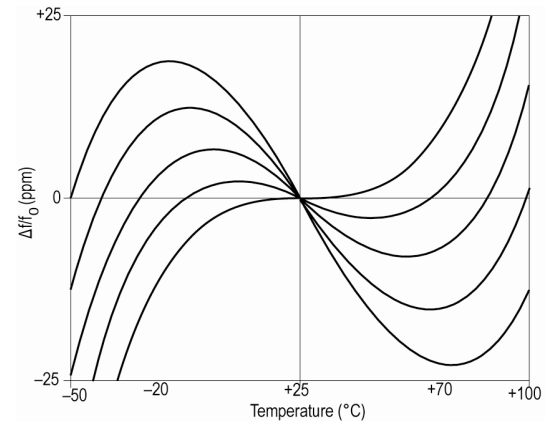
**Outline (mm)**

**Typical Frequency vs Temperature Curves**

**Sales Office Contact Details:**

 UK: +44 (0)1460 270200  
 Germany: 0800 1808 443

 France: 0800 901 383  
 USA: +1.760.318.2824

 Email: [info@iqdfrequencyproducts.com](mailto:info@iqdfrequencyproducts.com)  
 Web: [www.iqdfrequencyproducts.com](http://www.iqdfrequencyproducts.com)