



Chipsmall Limited consists of a professional team with an average of over 10 year of expertise in the distribution of electronic components. Based in Hongkong, we have already established firm and mutual-benefit business relationships with customers from,Europe,America and south Asia,supplying obsolete and hard-to-find components to meet their specific needs.

With the principle of “Quality Parts,Customers Priority,Honest Operation,and Considerate Service”,our business mainly focus on the distribution of electronic components. Line cards we deal with include Microchip,ALPS,ROHM,Xilinx,Pulse,ON,Everlight and Freescale. Main products comprise IC,Modules,Potentiometer,IC Socket,Relay,Connector.Our parts cover such applications as commercial,industrial, and automotives areas.

We are looking forward to setting up business relationship with you and hope to provide you with the best service and solution. Let us make a better world for our industry!



## Contact us

Tel: +86-755-8981 8866 Fax: +86-755-8427 6832

Email & Skype: info@chipsmall.com Web: www.chipsmall.com

Address: A1208, Overseas Decoration Building, #122 Zhenhua RD., Futian, Shenzhen, China



## Telecom Switch - 1 Form A Solid-State Relay

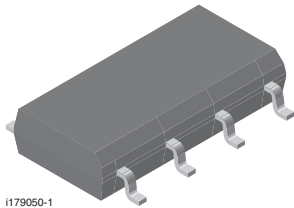

H179050-1

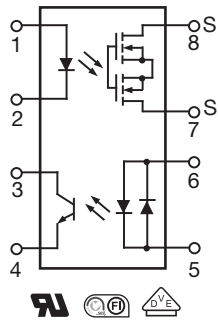

### DESCRIPTION

The LH1529FP and LH1529GP telecom switches consist of an optically coupled solid state relay (SSR) and a bidirectional input optocoupler. The SSR is ideal for performing switch hook and dial-pulse switching while the optocoupler performs ring detection and loop current sensing functions. Both the SSR and optocoupler provide 3000 V<sub>RMS</sub> of input to output isolation.

The SSR is integrated on a monolithic receptor die using high voltage technology. The SSR features low on resistance, high breakdown voltage and current-limit circuitry that protects the relay from telephone line induced lightning surges.

The optocoupler provides bidirectional current sensing via two anti parallel GaAs infrared emitting diodes. The opto channel provides a minimum CTR of 33 % at 6 mA.

The LH1529FP and LH1529GP come in an 8 pin, 0.080" thick plastic flat pak, SMD.

### FEATURES

- Solid-state relay and optocoupler in one package
- Surface mount package - new flat pak
- Isolation test voltage, 3000 V<sub>RMS</sub>
- LH1529FP, CTR min. = 33 %
- LH1529GP, CTR min. = 100 %
- Optocoupler
  - Bidirectional current detection
- Solid-state relay (equivalent to TS117P)
  - Typical R<sub>ON</sub> 20 Ω
  - Load voltage 350 V
  - Load current 120 mA
  - Current limit protection
  - High surge capability
  - Clean bounce free switching
  - Low power consumption
  - High reliability monolithic detector
- Compliant to RoHS Directive 2002/95/EC and in accordance to WEEE 2002/96/EC



RoHS  
COMPLIANT

### APPLICATIONS

- PCMCIA/Notebook
- General telecom switching
  - On/off hook control
  - Dial pulse
  - Ring current detection
  - Loop current sensing

### Note

- See "solid-state relays" (application note 56)

### AGENCY APPROVALS

UL1577: file no. E52744 system code O, double protection

DIN EN: 60747-5-2 (VDE 0884)/60747-5-5 (pending), available with option 1

FIMKO: approval

ORDERING INFORMATION	
<div style="display: flex; justify-content: space-around; align-items: center;"> <div style="border: 1px solid black; padding: 2px 5px;">L</div> <div style="border: 1px solid black; padding: 2px 5px;">H</div> <div style="border: 1px solid black; padding: 2px 5px;">1</div> <div style="border: 1px solid black; padding: 2px 5px;">5</div> <div style="border: 1px solid black; padding: 2px 5px;">2</div> <div style="border: 1px solid black; padding: 2px 5px;">9</div> <div style="border: 1px solid black; padding: 2px 5px;">#</div> <div style="border: 1px solid black; padding: 2px 5px;">#</div> <div style="border: 1px solid black; padding: 2px 5px;">T</div> <div style="border: 1px solid black; padding: 2px 5px;">R</div> </div> <p style="text-align: center; margin-top: 5px;"> <span style="margin-right: 100px;">PART NUMBER</span> <span style="margin-right: 100px;">PACKAGE CONFIG.</span> <span>TAPE AND REEL</span> </p>	<p>SMD-# 7 mm</p>
<b>PACKAGE</b>	<b>UL, FIMKO</b>
SMD-8, tape and reel	LH1529FPTR
SMD-8, tubes	LH1529GP
SMD-8, tape and reel	LH1529GPTR



ABSOLUTE MAXIMUM RATINGS (T <sub>amb</sub> = 25 °C, unless otherwise specified)				
PARAMETER	TEST CONDITION	SYMBOL	VALUE	UNIT
<b>SSR</b>				
<b>INPUT</b>				
LED continuous forward current		I <sub>F</sub>	50	mA
LED reverse voltage	I <sub>R</sub> ≤ 10 μA	V <sub>R</sub>	6	V
<b>OUTPUT</b>				
DC or peak AC load voltage	I <sub>L</sub> ≤ 50 μA	V <sub>L</sub>	350	V
Continuous DC load current		I <sub>L</sub>	120	mA
<b>SSR</b>				
Ambient temperature range		T <sub>amb</sub>	- 40 to + 85	°C
Storage temperature range		T <sub>stg</sub>	- 40 to + 125	°C
Soldering temperature <sup>(1)</sup>	t = 10 s max.	T <sub>slid</sub>	260	°C
Isolation test voltage (for 1 s)		V <sub>ISO</sub>	3000	V <sub>RMS</sub>
Isolation resistance	V <sub>IO</sub> = 500 V, T <sub>amb</sub> = 25 °C	R <sub>IO</sub>	≥ 10 <sup>12</sup>	Ω
	V <sub>IO</sub> = 500 V, T <sub>amb</sub> = 100 °C	R <sub>IO</sub>	≥ 10 <sup>11</sup>	Ω
Power dissipation		P <sub>diss</sub>	600	mW
<b>Optocoupler</b>				
<b>INPUT</b>				
LED continuous forward current		I <sub>F</sub>	50	mA
LED reverse voltage	I <sub>R</sub> ≤ 10 μA	V <sub>R</sub>	6	V
<b>OUTPUT</b>				
Collector emitter breakdown voltage		BV <sub>CEO</sub>	30	V
Phototransistor power dissipation		P <sub>diss</sub>	150	mW

**Notes**

- Stresses in excess of the absolute maximum ratings can cause permanent damage to the device. Functional operation of the device is not implied at these or any other conditions in excess of those given in the operational sections of this document. Exposure to absolute maximum ratings for extended periods of the time can adversely affect reliability.
- <sup>(1)</sup> Refer to reflow profile for soldering conditions for surface mounted devices.

ELECTRICAL CHARACTERISTICS (T <sub>amb</sub> = 25 °C, unless otherwise specified)							
PARAMETER	TEST CONDITION	PART	SYMBOL	MIN.	TYP.	MAX.	UNIT
<b>SSR</b>							
<b>INPUT</b>							
LED forward current, switch turn-on	I <sub>L</sub> = 100 mA, t = 10 ms		I <sub>Fon</sub>		1.1	3	mA
LED forward current, switch turn-off	V <sub>L</sub> = ± 300 V		I <sub>Foff</sub>	0.2	1		mA
LED forward voltage	I <sub>F</sub> = 10 mA		V <sub>F</sub>	1	1.2	1.5	V
<b>OUTPUT</b>							
On-resistance	I <sub>F</sub> = 5 mA, I <sub>L</sub> = ± 50 mA		R <sub>ON</sub>		20	25	Ω
Off-resistance	I <sub>F</sub> = 0 mA, V <sub>L</sub> = ± 100 V		R <sub>OFF</sub>		5000		GΩ
Current limit	I <sub>F</sub> = 5 mA, t = 5 ms		I <sub>Llimit</sub>	170	210	250	mA
Output off-state leakage current	I <sub>F</sub> = 0 mA, V <sub>L</sub> = ± 100 V		I <sub>O</sub>		0.6	200	nA
	I <sub>F</sub> = 0 mA, V <sub>L</sub> = ± 350 V		I <sub>O</sub>			1	μA
Output capacitance pin 7 to pin 8	I <sub>F</sub> = 0 mA, V <sub>L</sub> = 1 V		C <sub>O</sub>		55		pF
	I <sub>F</sub> = 0 mA, V <sub>L</sub> = 50 V		C <sub>O</sub>		10		pF
<b>OPTOCOUPLER</b>							
LED forward current	I <sub>F</sub> = 10 mA		V <sub>F</sub>	0.9	1.2	1.5	V
Saturation voltage	I <sub>F</sub> = 16 mA, I <sub>C</sub> = 2 mA		V <sub>CEsat</sub>		0.07	0.5	V
Dark current leakage	I <sub>F</sub> = 0 mA, V <sub>CE</sub> = 5 V		I <sub>CEO1</sub>			500	nA
Trickle current leakage	I <sub>F</sub> = 5 μA, V <sub>CE</sub> = 5 V		I <sub>CEO2</sub>			1	μA
DC current transfer ratio	I <sub>F</sub> = 6.0 mA, V <sub>CE</sub> = 0.5 V	LH1529FP	CTR <sub>DC</sub>	33	150		%
		LH1529GP, LH1529GPTR	CTR <sub>DC</sub>	100	150		%

**Note**

- Minimum and maximum values are testing requirements. Typical values are characteristics of the device and are the result of engineering evaluations. Typical values are for information only and are not part of the testing requirements.





SWITCHING CHARACTERISTICS ( $T_{amb} = 25\text{ }^{\circ}\text{C}$ , unless otherwise specified)							
PARAMETER	TEST CONDITION	PART	SYMBOL	MIN.	TYP.	MAX.	UNIT
Turn-on time	$I_F = 5\text{ mA}$ , $I_L = 50\text{ mA}$		$t_{on}$		1.3	2.5	ms
Turn-off time	$I_F = 5\text{ mA}$ , $I_L = 50\text{ mA}$		$t_{off}$		0.1	2.5	ms

**TYPICAL CHARACTERISTICS** ( $T_{amb} = 25\text{ }^{\circ}\text{C}$ , unless otherwise specified)

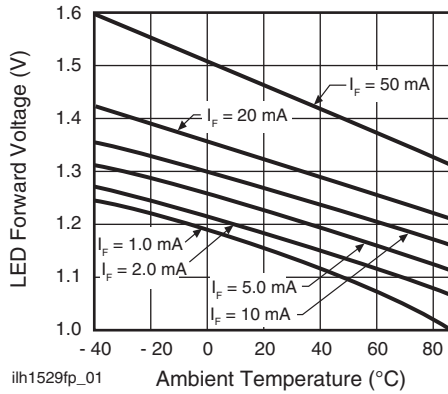

Fig. 1 - LED Voltage vs. Temperature

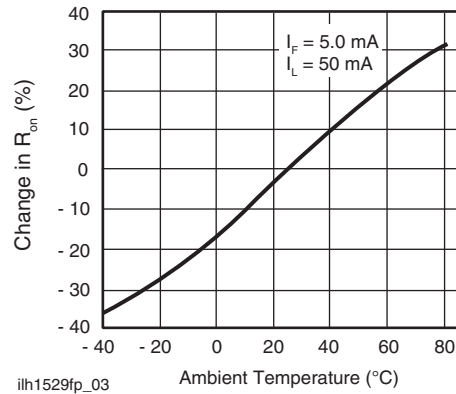

Fig. 3 - On-Resistance vs. Temperature

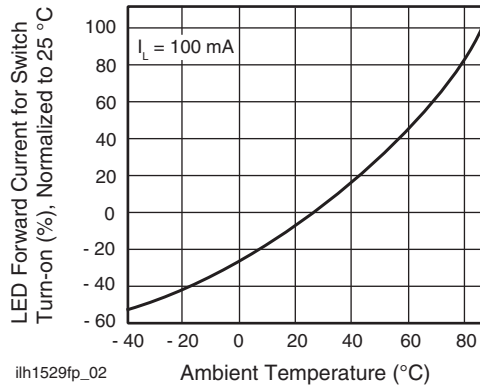

Fig. 2 - LED Current for Switch Turn-on vs. Temperature

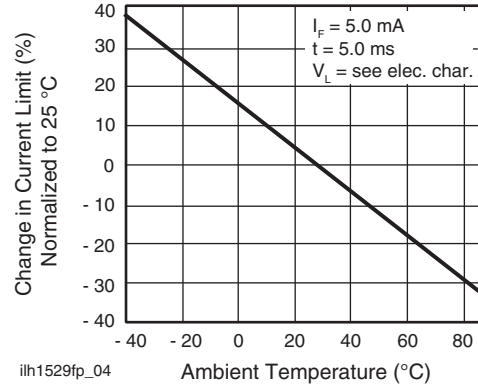

Fig. 4 - Current Limit vs. Temperature

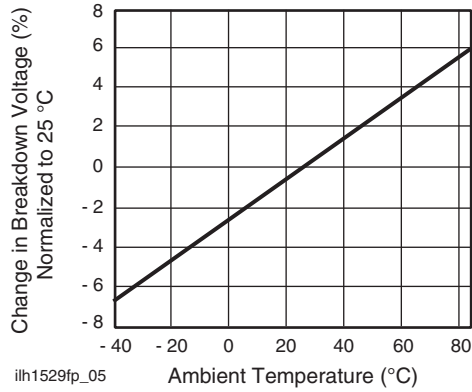

Fig. 5 - Switch Breakdown Voltage vs. Temperature

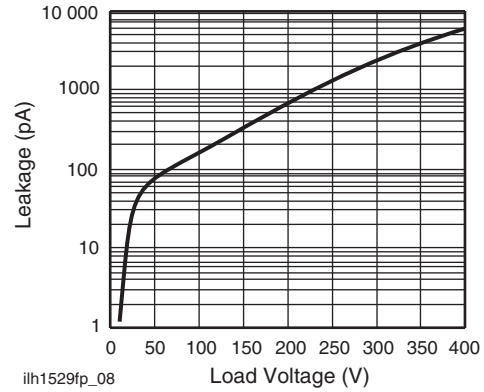

Fig. 8 - Leakage Current vs. Applied Voltage

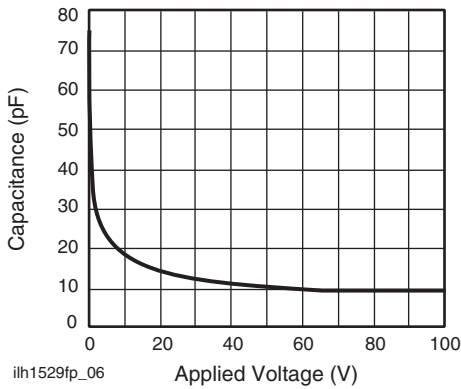

Fig. 6 - Switch Capacitance vs. Applied Voltage

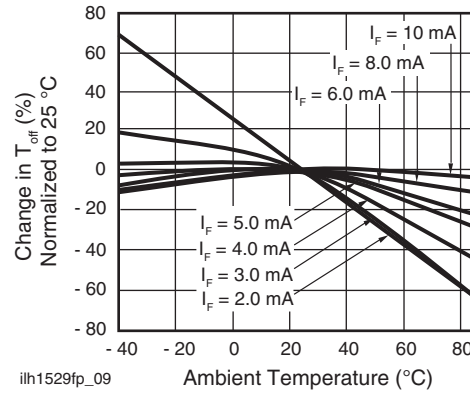

Fig. 9 - Turn-off Time vs. Temperature

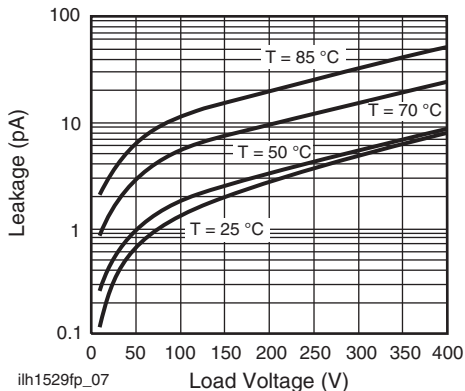

Fig. 7 - Leakage Current vs. Applied Voltage

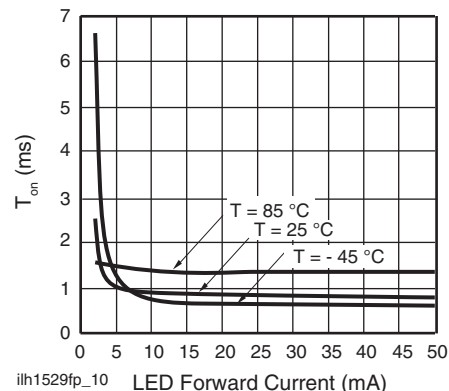
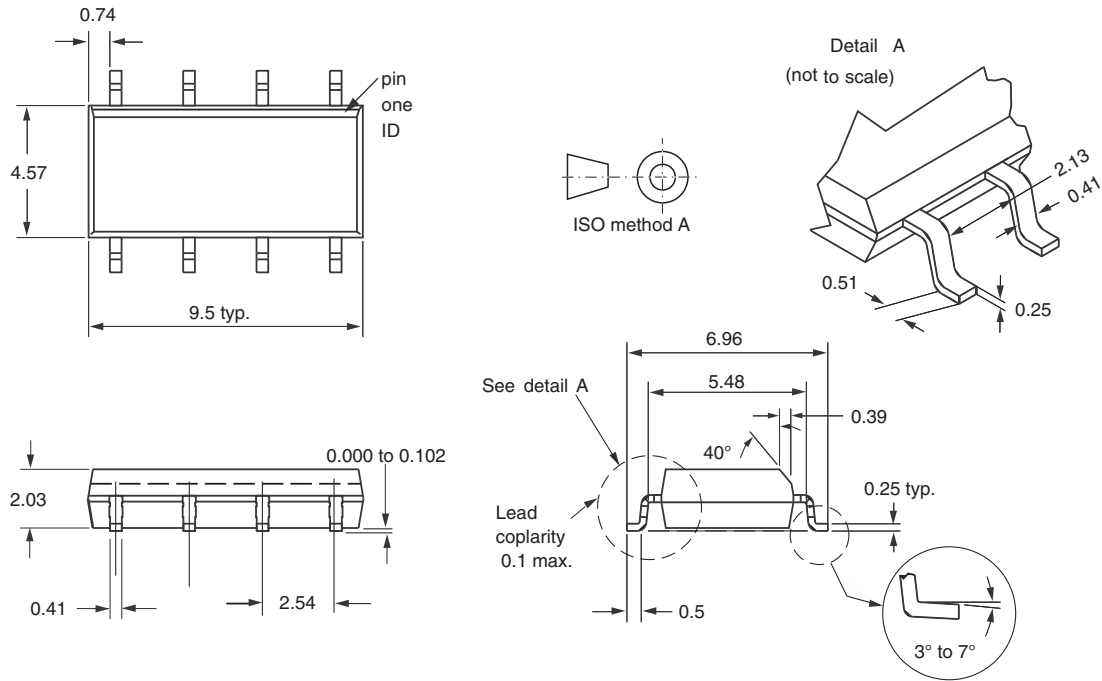

Fig. 10 - Turn-on Time vs. LED Current



## PACKAGE DIMENSIONS in millimeters



i178024

## PACKAGE MARKING (example)

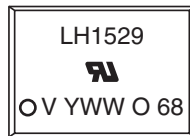

### Note

- Tape and reel suffix (TR) is not part of the package marking.



## Disclaimer

ALL PRODUCT, PRODUCT SPECIFICATIONS AND DATA ARE SUBJECT TO CHANGE WITHOUT NOTICE TO IMPROVE RELIABILITY, FUNCTION OR DESIGN OR OTHERWISE.

Vishay Intertechnology, Inc., its affiliates, agents, and employees, and all persons acting on its or their behalf (collectively, "Vishay"), disclaim any and all liability for any errors, inaccuracies or incompleteness contained in any datasheet or in any other disclosure relating to any product.

Vishay makes no warranty, representation or guarantee regarding the suitability of the products for any particular purpose or the continuing production of any product. To the maximum extent permitted by applicable law, Vishay disclaims (i) any and all liability arising out of the application or use of any product, (ii) any and all liability, including without limitation special, consequential or incidental damages, and (iii) any and all implied warranties, including warranties of fitness for particular purpose, non-infringement and merchantability.

Statements regarding the suitability of products for certain types of applications are based on Vishay's knowledge of typical requirements that are often placed on Vishay products in generic applications. Such statements are not binding statements about the suitability of products for a particular application. It is the customer's responsibility to validate that a particular product with the properties described in the product specification is suitable for use in a particular application. Parameters provided in datasheets and/or specifications may vary in different applications and performance may vary over time. All operating parameters, including typical parameters, must be validated for each customer application by the customer's technical experts. Product specifications do not expand or otherwise modify Vishay's terms and conditions of purchase, including but not limited to the warranty expressed therein.

Except as expressly indicated in writing, Vishay products are not designed for use in medical, life-saving, or life-sustaining applications or for any other application in which the failure of the Vishay product could result in personal injury or death. Customers using or selling Vishay products not expressly indicated for use in such applications do so at their own risk and agree to fully indemnify and hold Vishay and its distributors harmless from and against any and all claims, liabilities, expenses and damages arising or resulting in connection with such use or sale, including attorneys fees, even if such claim alleges that Vishay or its distributor was negligent regarding the design or manufacture of the part. Please contact authorized Vishay personnel to obtain written terms and conditions regarding products designed for such applications.

No license, express or implied, by estoppel or otherwise, to any intellectual property rights is granted by this document or by any conduct of Vishay. Product names and markings noted herein may be trademarks of their respective owners.

## Material Category Policy

**Vishay Intertechnology, Inc. hereby certifies that all its products that are identified as RoHS-Compliant fulfill the definitions and restrictions defined under Directive 2011/65/EU of The European Parliament and of the Council of June 8, 2011 on the restriction of the use of certain hazardous substances in electrical and electronic equipment (EEE) - recast, unless otherwise specified as non-compliant.**

**Please note that some Vishay documentation may still make reference to RoHS Directive 2002/95/EC. We confirm that all the products identified as being compliant to Directive 2002/95/EC conform to Directive 2011/65/EU.**