



Chipsmall Limited consists of a professional team with an average of over 10 year of expertise in the distribution of electronic components. Based in Hongkong, we have already established firm and mutual-benefit business relationships with customers from,Europe,America and south Asia,supplying obsolete and hard-to-find components to meet their specific needs.

With the principle of “Quality Parts,Customers Priority,Honest Operation,and Considerate Service”,our business mainly focus on the distribution of electronic components. Line cards we deal with include Microchip,ALPS,ROHM,Xilinx,Pulse,ON,Everlight and Freescale. Main products comprise IC,Modules,Potentiometer,IC Socket,Relay,Connector.Our parts cover such applications as commercial,industrial, and automotives areas.

We are looking forward to setting up business relationship with you and hope to provide you with the best service and solution. Let us make a better world for our industry!



Contact us

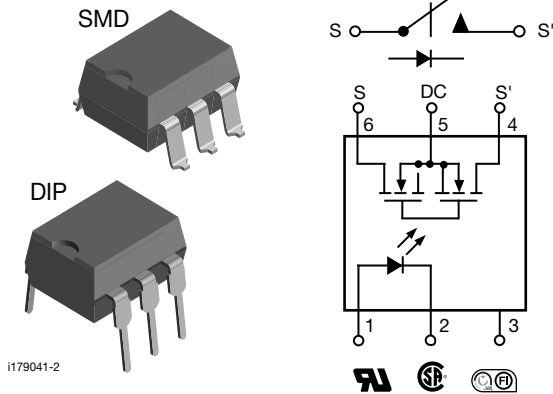
Tel: +86-755-8981 8866 Fax: +86-755-8427 6832

Email & Skype: info@chipsmall.com Web: www.chipsmall.com

Address: A1208, Overseas Decoration Building, #122 Zhenhua RD., Futian, Shenzhen, China



1 Form A Solid State Relay



i179041-2

DESCRIPTION

The LH1535 is robust, ideal for telecom and ground fault applications. It is an SPST normally open switch (form A) that replaces electromechanical relays in many applications. It is constructed using a GaAlAs LED for actuation control and an integrated monolithic die for the switch output. The die, fabricated in a high-voltage dielectrically isolated technology, is comprised of a photodiode array, switch control circuitry and MOSFET switches. In addition, it employs current-limiting circuitry which meets FCC 68.302 and other regulatory voltage surge requirements when overvoltage protection is provided.

FEATURES

- Current limit protection
- Isolation test voltage 5300 V_{RMS}
- Typical R_{ON} 20 Ω, max. 25 Ω
- Load voltage 400 V
- Load current 120 mA
- High surge capability
- Clean bounce free switching
- Low power consumption
- SMD lead available on tape and reel
- Compliant to RoHS Directive 2002/95/EC and in accordance to WEEE 2002/96/EC


RoHS
COMPLIANT

APPLICATIONS

- General telecom switching
- Instrumentation
- Industrial controls

Note

- See "solid state relays" (application note 56)

AGENCY APPROVALS

UL1577: file no. E52744 system code H, double protection

CSA: certification no. 093751

FIMKO: 25419

ORDERING INFORMATION														
L	H	1	5	3	5	#	#	#	T	R	DIP	SMD		
PART NUMBER						ELECTR. VARIATION			PACKAGE CONFIG.		TAPE AND REEL			
PACKAGE						UL, CSA, FIMKO								
SMD-6						LH1535AAB								
SMD-6, tape and reel						LH1535AABTR								
DIP-6, thru hole						LH1535AT								



ABSOLUTE MAXIMUM RATINGS (T _{amb} = 25 °C, unless otherwise specified)				
PARAMETER	TEST CONDITION	SYMBOL	VALUE	UNIT
INPUT				
LED continuous forward current		I _F	50	mA
LED reverse voltage	I _R ≤ 10 μA	V _R	8	V
OUTPUT				
DC or peak AC load voltage	I _L ≤ 50 μA	V _L	400	V
Continuous DC load current, bidirectional operation		I _L	120	mA
Continuous DC load current, unidirectional operation		I _L	250	mA
Peak load current (single shot)	t = 100 ms	I _P	(1)	mA
SSR				
Ambient temperature range		T _{amb}	- 40 to + 85	°C
Storage temperature range		T _{stg}	- 40 to + 150	°C
Pin soldering temperature (2)	t = 10 s max.	T _{sld}	260	°C
Input to output isolation test voltage		V _{ISO}	5300	V _{RMS}
Output power dissipation (continuous)		P _{diss}	550	mW

Notes

- Stresses in excess of the absolute maximum ratings can cause permanent damage to the device. Functional operation of the device is not implied at these or any other conditions in excess of those given in the operational sections of this document. Exposure to absolute maximum ratings for extended periods of the time can adversely affect reliability.
- (1) Refer to current limit performance application note for a discussion on relay operation during transient currents.
- (2) Refer to reflow profile for soldering conditions for surface mounted devices (SMD). Refer to wave profile for soldering conditions for through hole devices (DIP).

ELECTRICAL CHARACTERISTICS (T _{amb} = 25 °C, unless otherwise specified)						
PARAMETER	TEST CONDITION	SYMBOL	MIN.	TYP.	MAX.	UNIT
INPUT						
LED forward current, switch turn-on	I _L = 100 mA, t = 10 ms	I _{Fon}		0.75	2	mA
LED forward current, switch turn-off	V _L = ± 150 V, t = 100 ms	I _{Foff}	0.2	0.65		mA
LED forward voltage, switch turn-on	I _F = 10 mA	V _F	1.15	1.27	1.45	V
OUTPUT						
On-resistance AC/DC	I _F = 5 mA, I _L = 50 mA	R _{ON}	12	20	25	Ω
On-resistance DC	I _F = 5 mA, I _L = 100 mA	R _{ON}	3	6	6.25	Ω
Off-resistance	I _F = 0 mA, V _L = ± 100 V	R _{OFF}	0.5	200		GΩ
Current limit AC (1): pin 4 (±) to 6 (±)	I _F = 5 mA, V _L = ± 6 V, t = 5 ms	I _{LMT}	175	210	250	mA
Off-state leakage current	I _F = 0 mA, V _L = ± 100 V	I _O		0.5	200	nA
	I _F = 0 mA, V _L = ± 400 V	I _O		136		nA
Output capacitance	I _F = 0 mA, V _L = 1 V	C _O		21.6		pF
	I _F = 0 mA, V _L = 50 V	C _O		9		pF
Switch offset	I _F = 5 mA	V _{OS}		0.4		V
Breakdown voltage	I _F = 0 mA	V _{BR}		433		μV
TRANSFER						
Capacitance (input to output)	V _{ISO} = 1 V	C _{IO}		0.75		pF

Notes

- Minimum and maximum values are testing requirements. Typical values are characteristics of the device and are the result of engineering evaluations. Typical values are for information only and are not part of the testing requirements.
- (1) No DC mode current limit available.

SWITCHING CHARACTERISTICS (T _{amb} = 25 °C, unless otherwise specified)						
PARAMETER	TEST CONDITION	SYMBOL	MIN.	TYP.	MAX.	UNIT
Turn-on time	I _F = 5 mA, I _L = 50 mA	t _{on}		0.7	2	ms
Turn-off time	I _F = 5 mA, I _L = 50 mA	t _{off}		0.6	2	ms

SAFETY AND INSULATION RATINGS				
PARAMETER	TEST CONDITION	SYMBOL	VALUE	UNIT
Climatic classification	IEC 68 part 1		40/85/21	
Pollution degree	DIN VDE 0109		2	
Tracking resistance (comparative tracking index)	Insulation group IIIa	CTI	175	
Highest allowable overvoltage	Transient overvoltage	V_{IOTM}	8000	V_{peak}
Max. working insulation voltage	Recurring peak voltage	V_{IORM}	890	V_{peak}
Insulation resistance at 25 °C	$V_{IO} = 500 V$	R_{IS}	$\geq 10^{12}$	Ω
Insulation resistance at T_S		R_{IS}	$\geq 10^9$	Ω
Insulation resistance at 100 °C		R_{IS}	$\geq 10^{11}$	Ω
Partial discharge test voltage	Methode a, $V_{pd} = V_{IORM} \times 1.875$	V_{pd}	1669	V_{peak}
Safety limiting values - maximum values allowed in the event of a failure	Case temperature	T_{SI}	175	°C
	Input current	I_{SI}	300	mA
	Output power	P_{SO}	700	mW
Minimum external air gap (clearance)	Measured from input terminals to output terminals, shortest distance through air		≥ 7	mm
Minimum external tracking (creepage)	Measured from input terminals to output terminals, shortest distance path along body		≥ 7	mm

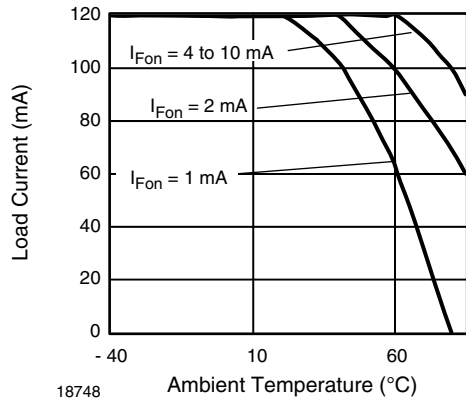
TYPICAL CHARACTERISTICS ($T_{amb} = 25\text{ °C}$, unless otherwise specified)


Fig. 1 - Recommended Operating Conditions

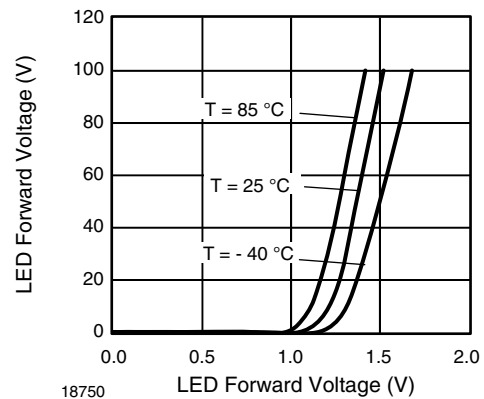


Fig. 3 - LED Forward Current vs. LED Forward Voltage

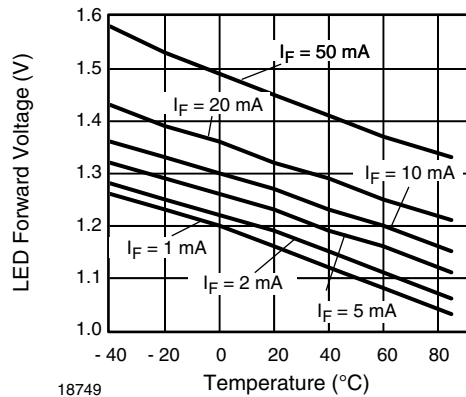


Fig. 2 - LED Voltage vs. Temperature

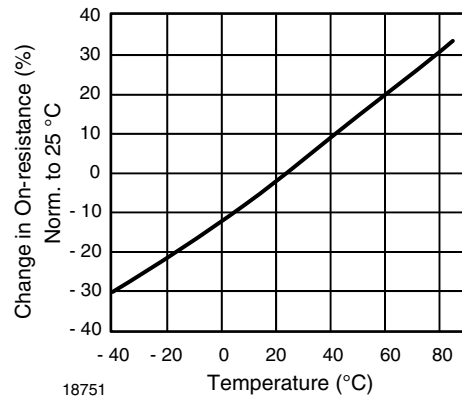


Fig. 4 - On-resistance vs. Temperature

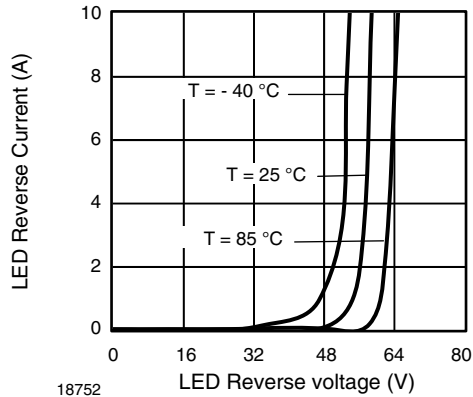


Fig. 5 - LED Reverse Current vs. LED Reverse Voltage

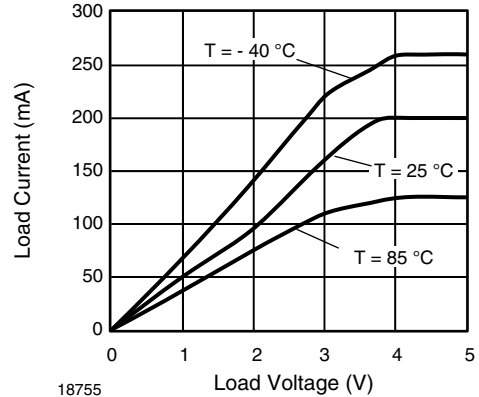


Fig. 8 - Load Current vs. Load Voltage

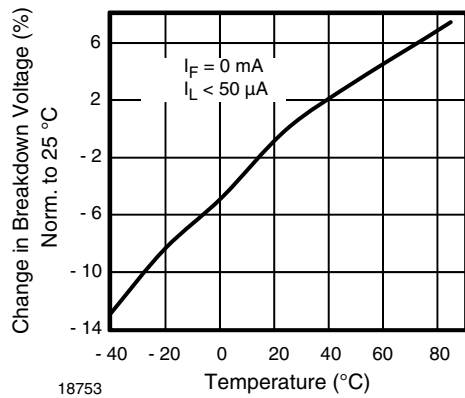


Fig. 6 - Switch Breakdown Voltage vs. Temperature

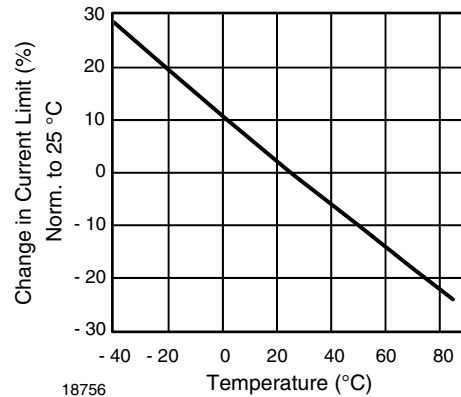


Fig. 9 - Current Limit vs. Temperature

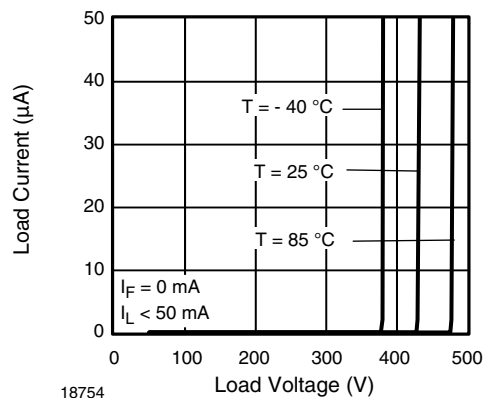


Fig. 7 - Switch Breakdown Voltage vs. Load Current

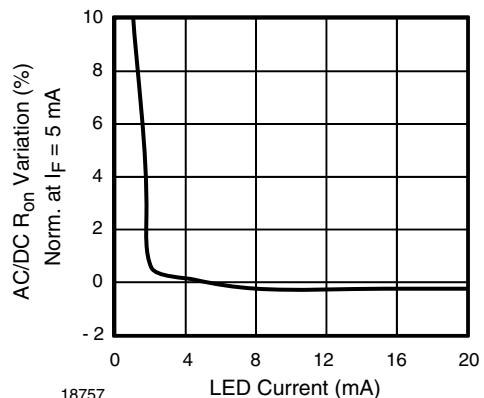


Fig. 10 - Variation in On-resistance vs. LED Current

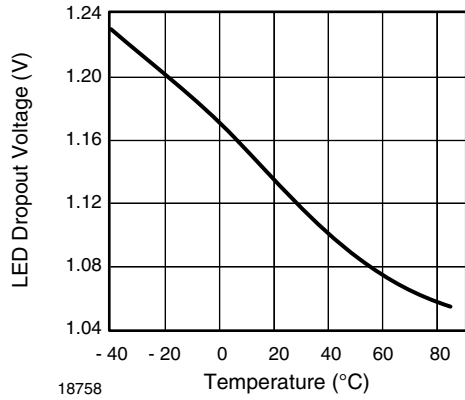


Fig. 11 - LED Dropout Voltage vs. Temperature

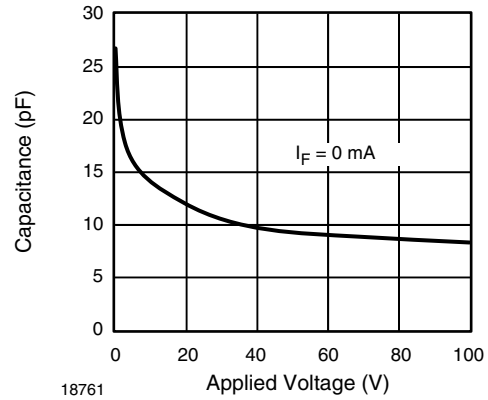


Fig. 14 - Switch Terminal Capacitance vs. Applied Voltage

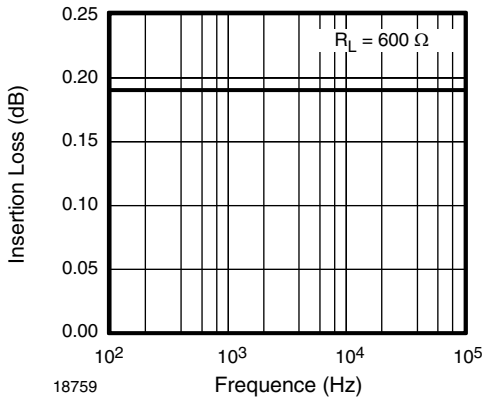


Fig. 12 - Insertion Loss vs. Frequency

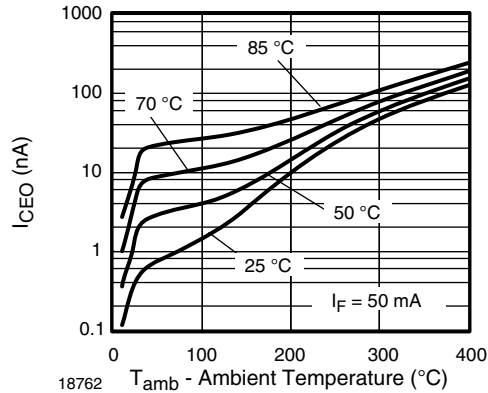


Fig. 15 - Leakage Current vs. Applied Voltage

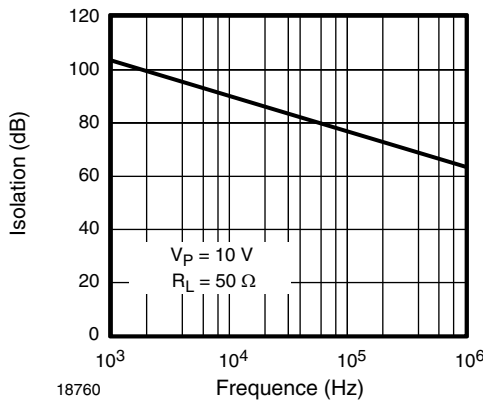


Fig. 13 - Output Isolation

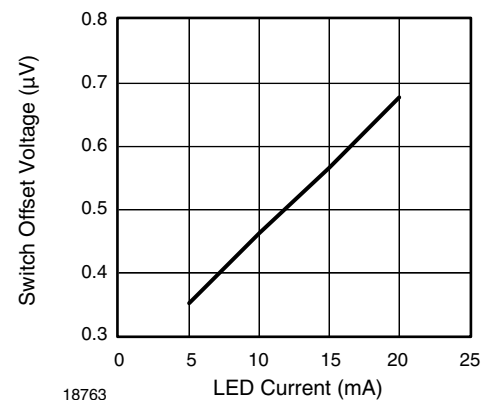


Fig. 16 - Switch Offset Voltage vs. LED Current

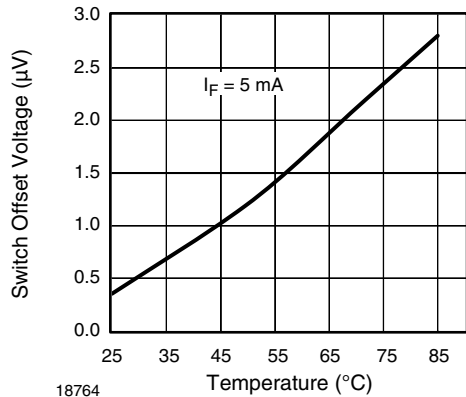


Fig. 17 - Switch Offset Voltage vs. Temperature

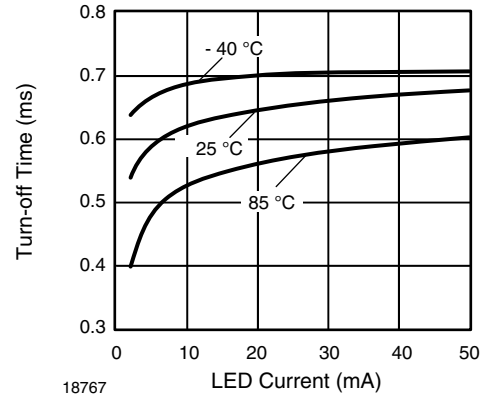


Fig. 20 - Turn-off Time vs. LED Current

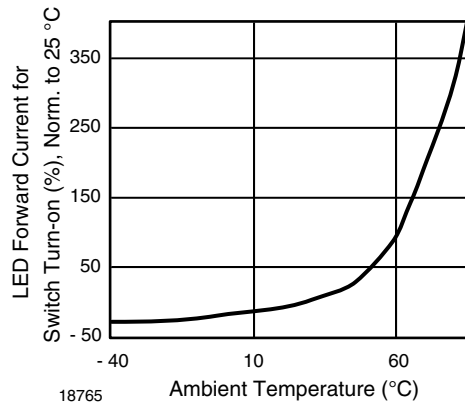


Fig. 18 - LED Current for Switch Turn-on vs. Temperature

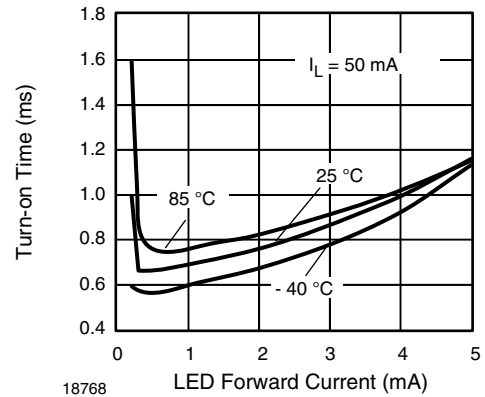


Fig. 21 - Turn-on Time vs. LED Current

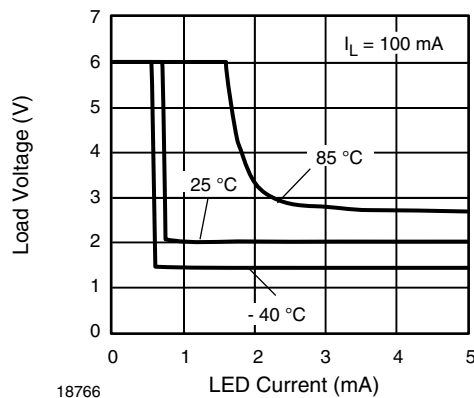


Fig. 19 - LED Current vs. Load Voltage

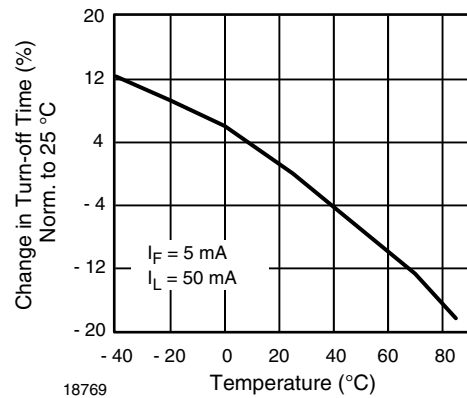


Fig. 22 - Turn-off Time vs. Temperature

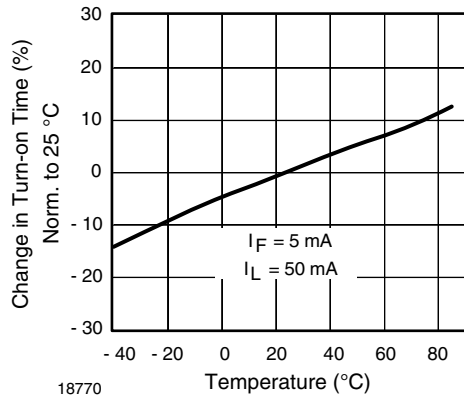
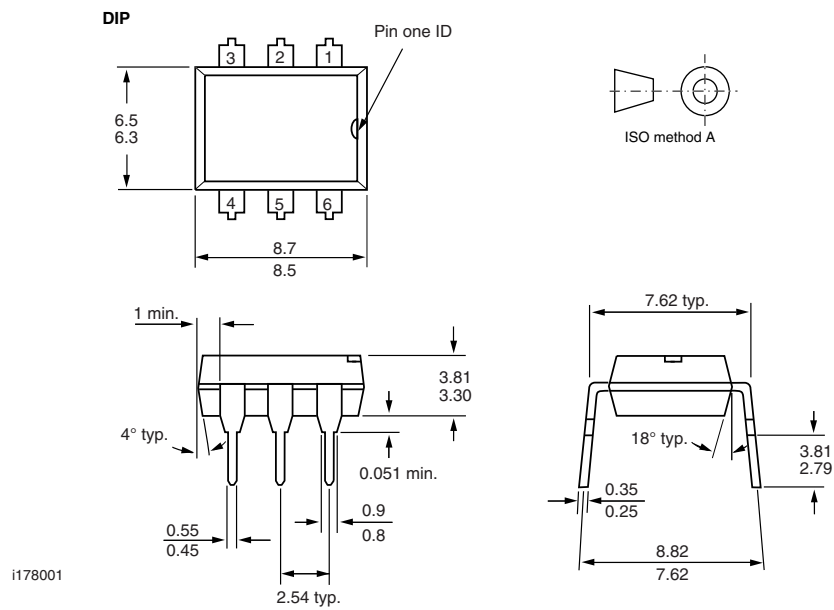
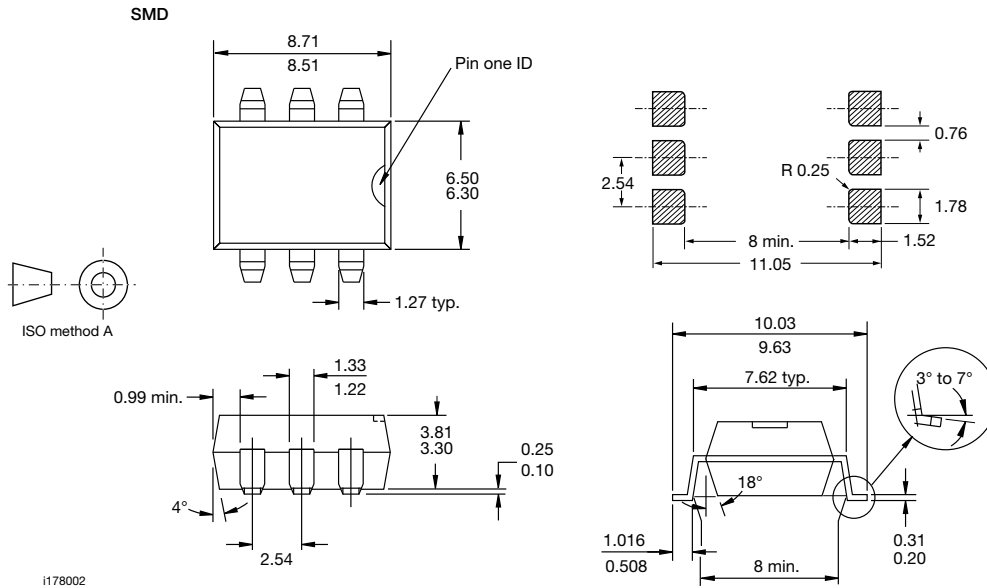


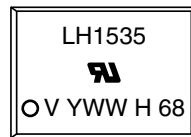
Fig. 23 - Turn-on Time vs. Temperature

PACKAGE DIMENSIONS in millimeters





PACKAGE MARKING



Note

- Tape and reel suffix (TR) is not part of the package marking.



Disclaimer

ALL PRODUCT, PRODUCT SPECIFICATIONS AND DATA ARE SUBJECT TO CHANGE WITHOUT NOTICE TO IMPROVE RELIABILITY, FUNCTION OR DESIGN OR OTHERWISE.

Vishay Intertechnology, Inc., its affiliates, agents, and employees, and all persons acting on its or their behalf (collectively, "Vishay"), disclaim any and all liability for any errors, inaccuracies or incompleteness contained in any datasheet or in any other disclosure relating to any product.

Vishay makes no warranty, representation or guarantee regarding the suitability of the products for any particular purpose or the continuing production of any product. To the maximum extent permitted by applicable law, Vishay disclaims (i) any and all liability arising out of the application or use of any product, (ii) any and all liability, including without limitation special, consequential or incidental damages, and (iii) any and all implied warranties, including warranties of fitness for particular purpose, non-infringement and merchantability.

Statements regarding the suitability of products for certain types of applications are based on Vishay's knowledge of typical requirements that are often placed on Vishay products in generic applications. Such statements are not binding statements about the suitability of products for a particular application. It is the customer's responsibility to validate that a particular product with the properties described in the product specification is suitable for use in a particular application. Parameters provided in datasheets and/or specifications may vary in different applications and performance may vary over time. All operating parameters, including typical parameters, must be validated for each customer application by the customer's technical experts. Product specifications do not expand or otherwise modify Vishay's terms and conditions of purchase, including but not limited to the warranty expressed therein.

Except as expressly indicated in writing, Vishay products are not designed for use in medical, life-saving, or life-sustaining applications or for any other application in which the failure of the Vishay product could result in personal injury or death. Customers using or selling Vishay products not expressly indicated for use in such applications do so at their own risk and agree to fully indemnify and hold Vishay and its distributors harmless from and against any and all claims, liabilities, expenses and damages arising or resulting in connection with such use or sale, including attorneys fees, even if such claim alleges that Vishay or its distributor was negligent regarding the design or manufacture of the part. Please contact authorized Vishay personnel to obtain written terms and conditions regarding products designed for such applications.

No license, express or implied, by estoppel or otherwise, to any intellectual property rights is granted by this document or by any conduct of Vishay. Product names and markings noted herein may be trademarks of their respective owners.