



Chipsmall Limited consists of a professional team with an average of over 10 year of expertise in the distribution of electronic components. Based in Hongkong, we have already established firm and mutual-benefit business relationships with customers from,Europe,America and south Asia,supplying obsolete and hard-to-find components to meet their specific needs.

With the principle of “Quality Parts,Customers Priority,Honest Operation,and Considerate Service”,our business mainly focus on the distribution of electronic components. Line cards we deal with include Microchip,ALPS,ROHM,Xilinx,Pulse,ON,Everlight and Freescale. Main products comprise IC,Modules,Potentiometer,IC Socket,Relay,Connector.Our parts cover such applications as commercial,industrial, and automotives areas.

We are looking forward to setting up business relationship with you and hope to provide you with the best service and solution. Let us make a better world for our industry!



## Contact us

Tel: +86-755-8981 8866 Fax: +86-755-8427 6832

Email & Skype: info@chipsmall.com Web: www.chipsmall.com

Address: A1208, Overseas Decoration Building, #122 Zhenhua RD., Futian, Shenzhen, China





# LIS244AL

## MEMS motion sensor: 2-axis - $\pm 2g$ ultracompact linear accelerometer

### Features

- Single voltage supply operation
- $\pm 2g$  full-scale
- Output voltage, offset and sensitivity are ratiometric to the supply voltage
- Factory trimmed device sensitivity and offset
- Embedded self test
- ECOPACK lead-free compliant
- High shock survivability (10000g)

### Description

The LIS244AL is an ultra compact consumer low-power two-axis linear accelerometer that includes a sensing element and an IC interface able to take the information from the sensing element and to provide an analog signal to the external world. The sensing element, capable of detecting the acceleration, is manufactured using a dedicated process developed by ST to produce inertial sensors and actuators in silicon. The IC interface is manufactured using a CMOS process that allows high level of integration to design a dedicated circuit which is trimmed to better match the sensing element characteristics.

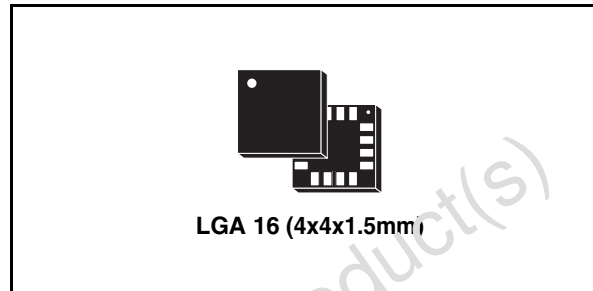

The LIS244AL is capable of measuring accelerations over a maximum bandwidth of 2.0kHz. The device bandwidth may be reduced by using external capacitances. A self-test capability allows the user to check the functioning of the system.

The LIS244AL is available in Land Grid Array package (LGA) and it is guaranteed to operate over an extended temperature range of  $-40^{\circ}\text{C}$  to  $+85^{\circ}\text{C}$ .

The LIS244AL belongs to a family of products suitable for a variety of applications:

- Mobile terminals
- Gaming and Virtual Reality input devices
- Antitheft systems and Inertial Navigation
- Appliance and Robotics.

Table 1. Device summary

| Order codes | Temp range, $^{\circ}\text{C}$                 | Package | Packing     |
|-------------|------------------------------------------------|---------|-------------|
| LIS244AL    | $-40^{\circ}\text{C}$ to $+85^{\circ}\text{C}$ | LGA-16  | Tray        |
| LIS244ALTR  | $-40^{\circ}\text{C}$ to $+85^{\circ}\text{C}$ | LGA-16  | Tape & Reel |

Note: Tape & Reel parts are compliant to International Standard EIA-481.

# Contents

|          |                                                       |           |
|----------|-------------------------------------------------------|-----------|
| <b>1</b> | <b>Block diagram &amp; pins description</b> .....     | <b>3</b>  |
| 1.1      | Block diagram .....                                   | 3         |
| 1.2      | Pin Description .....                                 | 3         |
| <b>2</b> | <b>Mechanical and electrical specifications</b> ..... | <b>5</b>  |
| 2.1      | Mechanical characteristics .....                      | 5         |
| 2.2      | Electrical characteristics .....                      | 6         |
| 2.3      | Absolute maximum ratings .....                        | 7         |
| 2.4      | Terminology .....                                     | 7         |
| <b>3</b> | <b>Functionality</b> .....                            | <b>9</b>  |
| 3.1      | Sensing element .....                                 | 9         |
| 3.2      | IC Interface .....                                    | 9         |
| 3.3      | Factory calibration .....                             | 9         |
| <b>4</b> | <b>Application hints</b> .....                        | <b>10</b> |
| 4.1      | Soldering information .....                           | 11        |
| 4.2      | Output Response vs. orientation .....                 | 11        |
| <b>5</b> | <b>Package information</b> .....                      | <b>12</b> |
| <b>6</b> | <b>Revision history</b> .....                         | <b>14</b> |

# 1 Block diagram & pins description

## 1.1 Block diagram

Figure 1. Block diagram

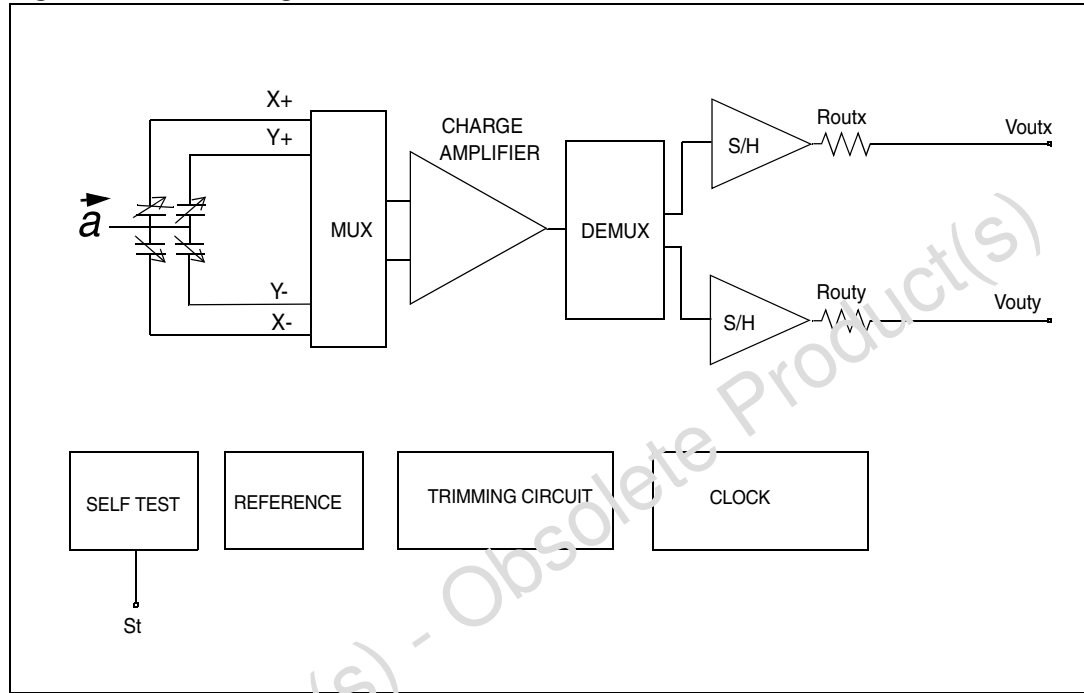

## 1.2 Pin Description

Figure 2. Pin Connection

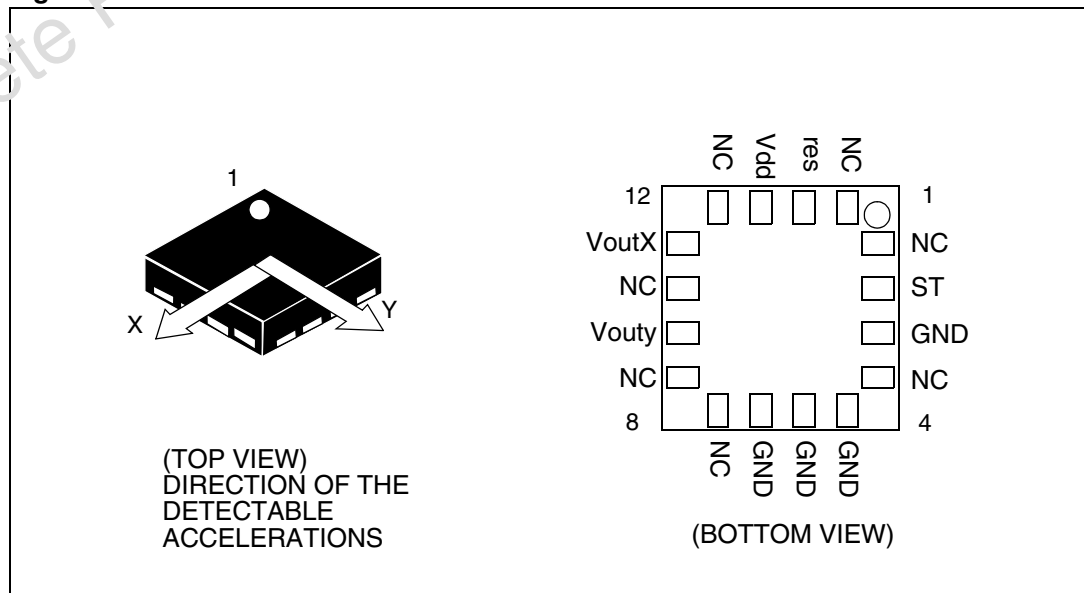

**Table 2. Pin description**

| Pin # | Pin name | Function                                                  |
|-------|----------|-----------------------------------------------------------|
| 1     | NC       | Not to be connected                                       |
| 2     | ST       | Self test (logic 0: normal mode; logic 1: self-test mode) |
| 3     | GND      | 0V supply                                                 |
| 4     | NC       | Not to be connected                                       |
| 5     | GND      | 0V supply                                                 |
| 6     | GND      | 0V supply                                                 |
| 7     | GND      | 0V supply                                                 |
| 8     | NC       | Not to be connected                                       |
| 9     | NC       | Not to be connected                                       |
| 10    | Vouty    | Output voltage Y channel                                  |
| 11    | NC       | Not to be connected                                       |
| 12    | Voutx    | Output voltage X channel                                  |
| 13    | NC       | Not to be connected                                       |
| 14    | Vdd      | Power supply                                              |
| 15    | Res      | Connect to Vdd                                            |
| 16    | NC       | Not to be connected                                       |

## 2 Mechanical and electrical specifications

### 2.1 Mechanical characteristics

(Temperature range -40°C to +85°C). All the parameters are specified @ Vdd =3.0V, T = 25°C unless otherwise noted

**Table 3. Mechanical characteristics<sup>(1)</sup>**

| Symbol  | Parameter                                         | Test condition                  | Min.            | Typ. <sup>(2)</sup> | Max.           | Unit   |
|---------|---------------------------------------------------|---------------------------------|-----------------|---------------------|----------------|--------|
| Ar      | Acceleration range <sup>(3)</sup>                 |                                 |                 | ±2                  |                | g      |
| So      | Sensitivity <sup>(5)</sup>                        |                                 | 0.140*Vdd - 10% | 0.140*Vdd           | 0.140*Vdd+ 10% | V/g    |
| SoDr    | Sensitivity change vs temperature                 | Delta from +25°C                |                 | 0.01                |                | %/°C   |
| Voff    | Zero-g level <sup>(4)</sup>                       | T = 25°C                        | Vdd/2-15%       | Vdd/2               | Vdd/2+15%      | V      |
| OffDr   | Zero-g level change vs temperature                | Delta from +25°C                |                 | 1                   |                | mg/°C  |
| NL      | Non linearity <sup>(5)</sup>                      | Best fit straight line          |                 | ±0.5                |                | % FS   |
| CrossAx | Cross-axis <sup>(6)</sup>                         |                                 |                 | ±2                  |                | %      |
| An      | Acceleration noise density                        | Vdd=3.0V                        |                 | 220                 |                | µg/√Hz |
| Vt      | Self test output voltage change <sup>(7)</sup> ,  | T = 25°C<br>Vdd= 3.0V<br>X axis |                 | 105                 |                | mV     |
|         |                                                   | T = 25°C<br>Vdd=3.0V<br>Y axis  |                 | 105                 |                | mV     |
| Fres    | Sensing element resonant frequency <sup>(8)</sup> | X, Yaxis                        | 4.0             |                     |                | kHz    |
| Toper   | Operating temperature range                       |                                 | -40             |                     | +85            | °C     |
| Wh      | Product weight                                    |                                 |                 | 0.040               |                | gram   |

- The product is factory calibrated at 3.0V. The operational power supply range is from 2.4V to 3.6V. Voff, So and Vt parameters will vary with supply voltage
- Typical specifications are not guaranteed
- Guaranteed by wafer level test and measurement of initial offset and sensitivity
- Zero-g level and sensitivity are essentially ratiometric to supply voltage at the calibration level ±8%
- Guaranteed by design
- Contribution to the measuring output of an inclination/acceleration along any perpendicular axis
- "Self test output voltage change" is defined as  $V_{out}(V_{st=Logic1}) - V_{out}(V_{st=Logic0})$
- Minimum resonance frequency Fres=4.0kHz. Sensor bandwidth= $1/(2*\pi*32k\Omega*Cloud)$

## 2.2 Electrical characteristics

(Temperature range -40°C to +85°C) All the parameters are specified @ Vdd =3.0V, T=25°C unless otherwise noted

**Table 4. Electrical characteristics<sup>(1)</sup>**

| Symbol | Parameter                        | Test condition | Min. | Typ. <sup>(2)</sup> | Max. | Unit |
|--------|----------------------------------|----------------|------|---------------------|------|------|
| Vdd    | Supply voltage                   |                | 2.4  | 3.0                 | 3.6  | V    |
| Idd    | Supply current                   |                |      | 0.65                |      | mA   |
| Vst    | Self test input                  | Logic 0 level  | 0    |                     | 0.8  | V    |
|        |                                  | Logic 1 level  | 2.0  |                     | Vdd  | V    |
| Rout   | Output impedance of Voutx, Vouty |                |      | 32                  |      | kΩ   |

1. The product is factory calibrated at 3.0V
2. Typical specifications are not guaranteed



**Note:** Minimum resonance frequency  $F_{res}=4.0\text{kHz}$ . Device bandwidth= $1/(2*\pi*32\text{k}\Omega*Cl_{load})$

## 2.3 Absolute maximum ratings

Stresses above those listed as “absolute maximum ratings” may cause permanent damage to the device. This is a stress rating only and functional operation of the device under these conditions is not implied. Exposure to maximum rating conditions for extended periods may affect device reliability.

**Table 5. Absolute maximum ratings**

| Symbol           | Ratings                                                 | Maximum value                | Unit |
|------------------|---------------------------------------------------------|------------------------------|------|
| V <sub>DD</sub>  | Supply voltage                                          | -0.3 to 6                    | V    |
| V <sub>IN</sub>  | Input voltage on any control pin (ST)                   | -0.3 to V <sub>DD</sub> +0.3 | V    |
| A <sub>POW</sub> | Acceleration (any axis, powered, V <sub>DD</sub> =3.0V) | 3000g for 0.5 ms             |      |
|                  |                                                         | 10000g for 0.1 ms            |      |
| A <sub>UNP</sub> | Acceleration (any axis, not powered)                    | 3000g for 0.5 ms             |      |
|                  |                                                         | 10000g for 0.1 ms            |      |
| T <sub>STG</sub> | Storage temperature range                               | -40 to +125                  | °C   |

|                                                                                     |                                                                                                        |
|-------------------------------------------------------------------------------------|--------------------------------------------------------------------------------------------------------|
|   | This is a Mechanical Shock sensitive device, improper handling can cause permanent damages to the part |
|  | This is an ESD sensitive device, improper handling can cause permanent damages to the part             |

## 2.4 Terminology

**Sensitivity** describes the gain of the sensor and can be determined by applying 1g acceleration to it. As the sensor can measure DC accelerations this can be done easily by pointing the axis of interest towards the center of the earth, note the output value, rotate the sensor by 180 degrees (point to the sky) and note the output value again thus applying ±1g acceleration to the sensor. Subtracting the larger output value from the smaller one and dividing the result by 2 will give the actual sensitivity of the sensor. This value changes very little over temperature (see sensitivity change vs. temperature) and also very little over time. The sensitivity tolerance describes the range of sensitivities of a large population of sensors.

**Zero-g level** describes the actual output signal if there is no acceleration present. A sensor in a steady state on a horizontal surface will measure 0g in X axis and 0g in Y axis. The output is ideally for a 3.0V powered sensor  $V_{DD}/2 = 1500mV$ . A deviation from ideal 0-g level (1500mV in this case) is called Zero-g offset. Offset of precise MEMS sensors is to some extent a result of stress to the sensor and therefore the offset can slightly change after mounting the sensor onto a printed circuit board or exposing it to extensive mechanical stress. Offset changes little over temperature - see “Zero-g level change vs. temperature” - the Zero-g level of an individual sensor is very stable over lifetime. The Zero-g level tolerance describes the range of Zero-g levels of a population of sensors.



**Self Test** allows to test the mechanical and electric part of the sensor, allowing the seismic mass to be moved by means of an electrostatic test-force. The Self Test function is off when the ST pin is connected to GND. When the ST pin is tied at Vdd an actuation force is applied to the sensor, simulating a definite input acceleration. In this case the sensor outputs will exhibit a voltage change in their DC levels which is depending on the supply voltage through the device sensitivity. When ST is activated, the device output level is given by the algebraic sum of the signals produced by the acceleration acting on the sensor and by the electrostatic test-force. If the output signals change within the amplitude specified inside [Table 3](#), then the sensor is working properly and the parameters of the interface chip are within the defined specification.

**Output impedance** describes the resistor inside the output stage of each channel. This resistor is part of a filter consisting of an external capacitor of at least 2.5nF and the internal resistor. Due to the resistor level, only small inexpensive external capacitors are needed to generate low corner frequencies. When interfacing with an ADC it is important to use high input impedance input circuitries to avoid measurement errors. Note that the minimum load capacitance forms a corner frequency close to the resonance frequency of the sensor. In general the smallest possible bandwidth for a particular application should be chosen to get the best results.

## 3 Functionality

The LIS244AL is an ultra compact low-power, analog output two-axis linear accelerometer packaged in a LGA package. The complete device includes a sensing element and an IC interface able to take the information from the sensing element and to provide an analog signal to the external world.

### 3.1 Sensing element

A proprietary process is used to create a surface micro-machined accelerometer. The technology allows to carry out suspended silicon structures which are attached to the substrate in a few points called anchors and are free to move in the direction of the sensed acceleration. To be compatible with the traditional packaging techniques a cap is placed on top of the sensing element to avoid blocking the moving parts during the moulding phase of the plastic encapsulation.

When an acceleration is applied to the sensor the proof mass displaces from its nominal position, causing an imbalance in the capacitive half-bridge. This imbalance is measured using charge integration in response to a voltage pulse applied to the sense capacitor.

At steady state the nominal value of the capacitors are few pF and when an acceleration is applied the maximum variation of the capacitive load is in pF range.

### 3.2 IC Interface

The complete signal processing uses a fully differential structure, while the final stage converts the differential signal into a single-ended one to be compatible with the external world.

The first stage is a low-noise capacitive amplifier that implements a Correlated Double Sampling (CDS) at its output to cancel the offset and the  $1/f$  noise. The produced signal is then sent to two different S&Hs, one for each channel, and made available to the outside.

All the analog parameters (output offset voltage and sensitivity) are ratiometric to the voltage supply. Increasing or decreasing the voltage supply, the sensitivity and the offset will increase or decrease linearly. The feature provides the cancellation of the error related to the voltage supply along an analog to digital conversion chain.

### 3.3 Factory calibration

The IC interface is factory calibrated for sensitivity ( $S_0$ ) and Zero-g level ( $V_{off}$ ).

The trimming values are stored inside the device by a non volatile structure. Any time the device is turned on, the trimming parameters are downloaded into the registers to be employed during the normal operation. This allows the user to employ the device without further calibration.

## 4 Application hints

Figure 3. LIS244AL Electrical connection

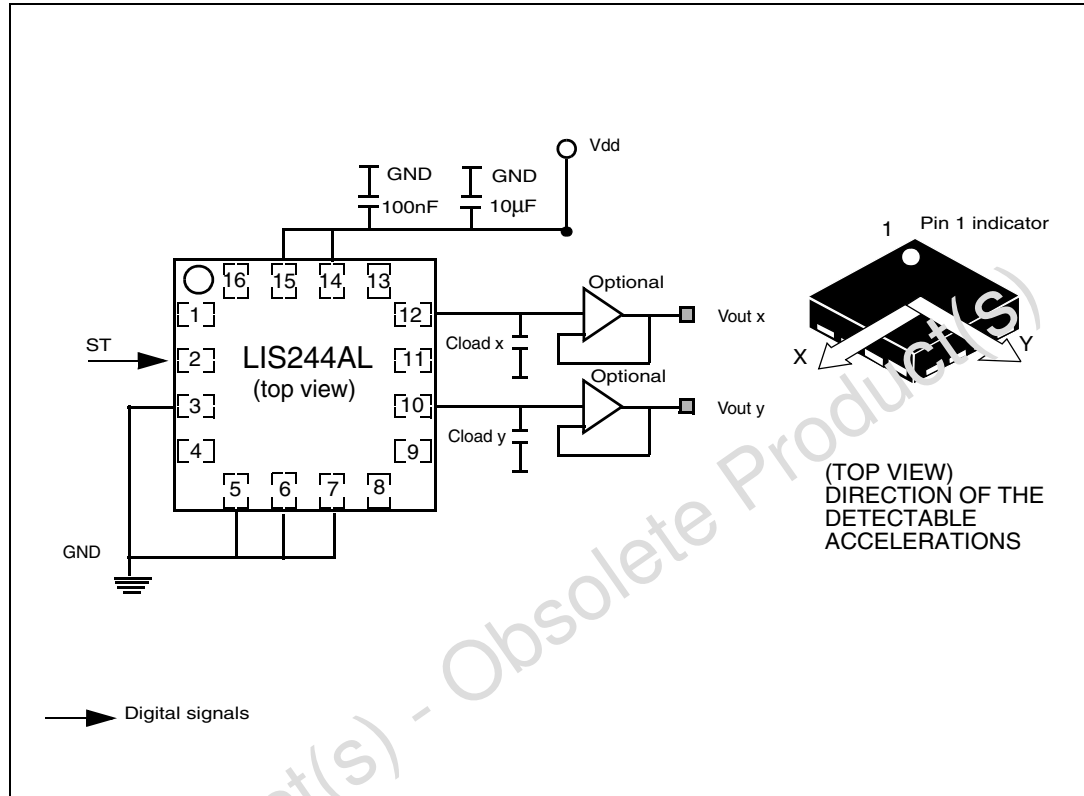

Power supply decoupling capacitors (100nF ceramic or polyester + 10µF Aluminum) should be placed as near as possible to the device (common design practice).

The LIS244AL allows to band limit Voutx, Vouty through the use of external capacitors. The recommended frequency range spans from DC up to 2.0kHz. In particular, capacitors are added at output Voutx, Vouty pins to implement low-pass filtering for antialiasing and noise reduction. The equation for the cut-off frequency ( $f_t$ ) of the external filters is in this case:

**Equation 1**

$$f_t = \frac{1}{2\pi \cdot R_{out} \cdot C_{load}(x, y)}$$

Taking into account that the internal filtering resistor ( $R_{out}$ ) has a nominal value equal to 32kΩ, the equation for the external filter cut-off frequency may be simplified as follows:

**Equation 2**

$$f_t = \frac{5\mu F}{C_{load}^{x, y}} [Hz]$$

The tolerance of the internal resistor can vary typically of  $\pm 20\%$  within its nominal value of  $32k\Omega$ ; thus the cut-off frequency will vary accordingly. A minimum capacitance of  $2.5nF$  for  $C_{load}(x, y)$  is required.

**Table 6. Filter Capacitor Selection,  $C_{load}(x,y)$ ,**

| Cut-off frequency | Capacitor value |
|-------------------|-----------------|
| 1 Hz              | 5 $\mu F$       |
| 10 Hz             | 0.5 $\mu F$     |
| 20 Hz             | 250nF           |
| 50 Hz             | 100nF           |
| 100 Hz            | 50nF            |
| 200 Hz            | 25nF            |
| 500 Hz            | 10nF            |

### 4.1 Soldering information

The LGA package is compliant with the ECOPACK, RoHS and “Green” standard.

Pin1 indicator is electrically connected to pin 1. Leave pin 1 indicator unconnected during soldering.

### 4.2 Output Response vs. orientation

**Figure 4. Output response vs. orientation**

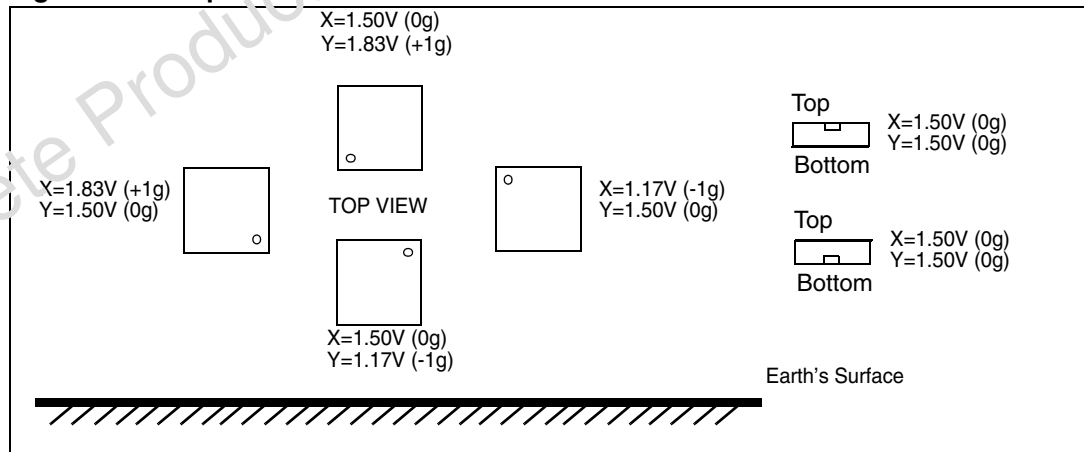

Figure 4 refers to LIS244AL powered at 3.0V.

## 5 Package information

In order to meet environmental requirements, ST offers these devices in ECOPACK® packages. These packages have a Lead-free second level interconnect. The category of second Level Interconnect is marked on the package and on the inner box label, in compliance with JEDEC Standard JESD97. The maximum ratings related to soldering conditions are also marked on the inner box label. ECOPACK is an ST trademark.

ECOPACK specifications are available at: [www.st.com](http://www.st.com).

Obsolete Product(s) - Obsolete Product(s)

Figure 5. LGA 16: mechanical data & package dimensions

| Ref. | Dimensions |       |       |       |        |       |
|------|------------|-------|-------|-------|--------|-------|
|      | mm         |       |       | inch  |        |       |
|      | Min.       | Typ.  | Max.  | Min.  | Typ.   | Max.  |
| A1   |            | 1     | 1.60  |       | 0.039  | 0.063 |
| A2   |            |       | 1.33  |       |        | 0.052 |
| A3   | 0.160      | 0.20  | 0.24  | 0.006 | 0.008  | 0.009 |
| D1   | 3.850      | 4.0   | 4.150 | 0.152 | 0.157  | 0.163 |
| E1   | 3.850      | 4.0   | 4.150 | 0.152 | 0.157  | 0.163 |
| L    |            | 0.65  |       |       | 0.026  |       |
| L1   |            | 1.95  |       |       | 0.077  |       |
| N    |            | 0.98  |       |       | 0.039  |       |
| N1   |            | 1.90  |       |       | 0.075  |       |
| T1   |            | 0.40  |       |       | 0.016  |       |
| T2   |            | 0.30  |       |       | 0.012  |       |
| P1   |            | 1.750 |       |       | 0.069  |       |
| P2   |            | 1.525 |       |       | 0.060  |       |
| R    |            | 0.30  |       |       | 0.012  |       |
| S    |            | 0.10  |       |       | 0.004  |       |
| k    |            | 0.05  |       |       | 0.0019 |       |

Outline and mechanical data

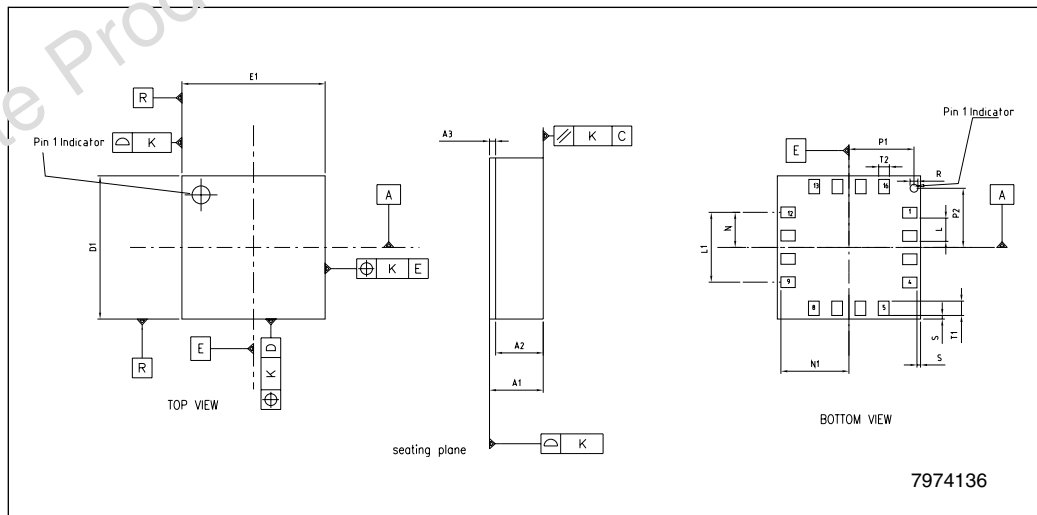
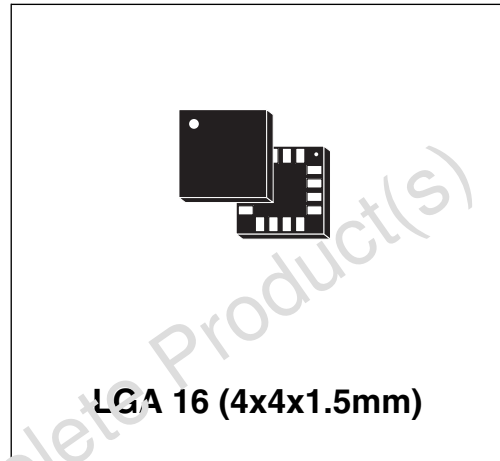

## 6 Revision history

Table 7. Document revision history

| Date        | Revision | Changes         |
|-------------|----------|-----------------|
| 29-Jun-2007 | 1        | Initial release |

Obsolete Product(s) - Obsolete Product(s)

**Please Read Carefully:**

Information in this document is provided solely in connection with ST products. STMicroelectronics NV and its subsidiaries ("ST") reserve the right to make changes, corrections, modifications or improvements, to this document, and the products and services described herein at any time, without notice.

All ST products are sold pursuant to ST's terms and conditions of sale.

Purchasers are solely responsible for the choice, selection and use of the ST products and services described herein, and ST assumes no liability whatsoever relating to the choice, selection or use of the ST products and services described herein.

No license, express or implied, by estoppel or otherwise, to any intellectual property rights is granted under this document. If any part of this document refers to any third party products or services it shall not be deemed a license grant by ST for the use of such third party products or services, or any intellectual property contained therein or considered as a warranty covering the use in any manner whatsoever of such third party products or services or any intellectual property contained therein.

**UNLESS OTHERWISE SET FORTH IN ST'S TERMS AND CONDITIONS OF SALE ST DISCLAIMS ANY EXPRESS OR IMPLIED WARRANTY WITH RESPECT TO THE USE AND/OR SALE OF ST PRODUCTS INCLUDING WITHOUT LIMITATION IMPLIED WARRANTIES OF MERCHANTABILITY, FITNESS FOR A PARTICULAR PURPOSE (AND THEIR EQUIVALENTS UNDER THE LAWS OF ANY JURISDICTION), OR INFRINGEMENT OF ANY PATENT, COPYRIGHT OR OTHER INTELLECTUAL PROPERTY RIGHT.**

**UNLESS EXPRESSLY APPROVED IN WRITING BY AN AUTHORIZED ST REPRESENTATIVE, ST PRODUCTS ARE NOT RECOMMENDED, AUTHORIZED OR WARRANTED FOR USE IN MILITARY, AIR CRAFT, SPACE, LIFE SAVING, OR LIFE SUSTAINING APPLICATIONS, NOR IN PRODUCTS OR SYSTEMS WHERE FAILURE OR MALFUNCTION MAY RESULT IN PERSONAL INJURY, DEATH, OR SEVERE PROPERTY OR ENVIRONMENTAL DAMAGE. ST PRODUCTS WHICH ARE NOT SPECIFIED AS "AUTOMOTIVE GRADE" MAY ONLY BE USED IN AUTOMOTIVE APPLICATIONS AT USER'S OWN RISK.**

Resale of ST products with provisions different from the statements and/or technical features set forth in this document shall immediately void any warranty granted by ST for the ST product or service described herein and shall not create or extend in any manner whatsoever, any liability of ST.

ST and the ST logo are trademarks or registered trademarks of ST in various countries.

Information in this document supersedes and replaces all information previously supplied.

The ST logo is a registered trademark of STMicroelectronics. All other names are the property of their respective owners.

© 2007 STMicroelectronics - All rights reserved

STMicroelectronics group of companies

Australia - Belgium - Brazil - Canada - China - Czech Republic - Finland - France - Germany - Hong Kong - India - Israel - Italy - Japan - Malaysia - Malta - Morocco - Singapore - Spain - Sweden - Switzerland - United Kingdom - United States of America

[www.st.com](http://www.st.com)