



Chipsmall Limited consists of a professional team with an average of over 10 year of expertise in the distribution of electronic components. Based in Hongkong, we have already established firm and mutual-benefit business relationships with customers from,Europe,America and south Asia,supplying obsolete and hard-to-find components to meet their specific needs.

With the principle of “Quality Parts,Customers Priority,Honest Operation,and Considerate Service”,our business mainly focus on the distribution of electronic components. Line cards we deal with include Microchip,ALPS,ROHM,Xilinx,Pulse,ON,Everlight and Freescale. Main products comprise IC,Modules,Potentiometer,IC Socket,Relay,Connector.Our parts cover such applications as commercial,industrial, and automotives areas.

We are looking forward to setting up business relationship with you and hope to provide you with the best service and solution. Let us make a better world for our industry!



Contact us

Tel: +86-755-8981 8866 Fax: +86-755-8427 6832

Email & Skype: info@chipsmall.com Web: www.chipsmall.com

Address: A1208, Overseas Decoration Building, #122 Zhenhua RD., Futian, Shenzhen, China



Ref: LKSR 6-NP, LKSR 15-NP, LKSR 25-NP, LKSR 50-NP

For the electronic measurement of current: DC, AC, pulsed..., with galvanic separation between the primary and the secondary circuit.

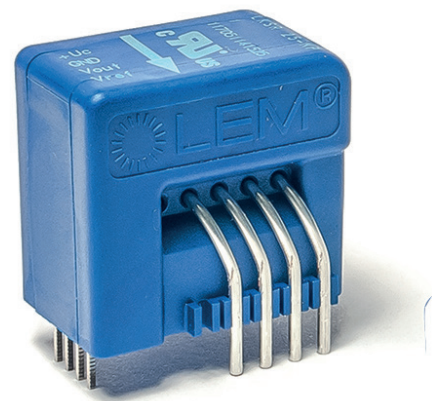

Features

- Closed loop multi-range current transducer
- Voltage output
- Unipolar supply voltage
- Compact design for PCB mounting.

Advantages

- Very low offset drift
- Very good dv/dt immunity
- CKSR footprint compatible
- Reference pin with two modes: Ref IN and Ref OUT
- Extended measuring range for unipolar measurement.

Applications

- AC variable speed and servo motor drives
- Static converters for DC motor drives
- Battery supplied applications
- Uninterruptible Power Supplies (UPS)
- Switched Mode Power Supplies (SMPS)
- Power supplies for welding applications
- Solar inverters.

Standards

- IEC 61800-1: 1997
- IEC 61800-2: 2015
- IEC 61800-3: 2004
- IEC 61800-5-1: 2007
- IEC 62109-1: 2010
- IEC 62477-1: 2012
- UL 508:2013.

Application Domain

- Industrial.

Absolute maximum ratings

Parameter	Symbol	Unit	Value
Maximum supply voltage	$U_{C \max}$	V	7
Maximum primary conductor temperature	$T_{B \max}$	°C	110
Maximum primary current	$I_{P \max}$	A	$20 \times I_{PN}$
Maximum electrostatic discharge voltage	$U_{ESD \max}$	kV	4

Stresses above these ratings may cause permanent damage. Exposure to absolute maximum ratings for extended periods may degrade reliability.

UL 508: Ratings and assumptions of certification

File # E189713 Volume: 2 Section: 11

Standards

- CSA C22.2 NO. 14-10 INDUSTRIAL CONTROL EQUIPMENT - Date 2011/08/01
- UL 508 STANDARD FOR INDUSTRIAL CONTROL EQUIPMENT - Date 2013

Ratings

Parameter	Symbol	Unit	Value
Primary involved potential		V AC/DC	1000
Max surrounding air temperature	T_A	°C	105
Primary current	I_P	A	According to series primary currents
Secondary supply voltage	U_C	V DC	7
Output voltage	V_{out}	V	0 to 5

Conditions of acceptability

When installed in the end-use equipment, consideration shall be given to the following:

- 1 - These devices must be mounted in a suitable end-use enclosure.
- 2 - The terminals have not been evaluated for field wiring.
- 3 - The LES, LESR, LKSR, LPSR, LXS and LXSR Series shall be used in a pollution degree 2 environment or better.
- 4 - Low voltage circuits are intended to be powered by a circuit derived from an isolating source (such as a transformer, optical isolator, limiting impedance or electro-mechanical relay) and having no direct connection back to the primary circuit (other than through the grounding means).
- 5 - These devices are intended to be mounted on the printed wiring board of the end-use equipment (with a minimum CTI of 100).
- 6 - LES, LESR, LKSR and LPSR Series: based on results of temperature tests, in the end-use application, a maximum of 110°C cannot be exceeded on the primary jumper.

Marking

Only those products bearing the UL or UR Mark should be considered to be Listed or Recognized and covered under UL's Follow-Up Service. Always look for the Mark on the product.

Insulation coordination

Parameter	Symbol	Unit	Value	Comment
RMS voltage for AC insulation test, 50 Hz, 1 min	U_d	kV	4.3	
Impulse withstand voltage 1.2/50 μ s	\hat{U}_w	kV	8	
Insulation resistance	R_{INS}	G Ω	18	measured at 500 V DC
Partial discharge RMS test voltage ($q_m < 10$ pC)	U_t	kV	1.65	
Clearance (pri. - sec.)	d_{Cl}	mm		See dimensions drawing on page 19
Creepage distance (pri. - sec.)	d_{Cp}			
Case material	-	-	V0 according to UL 94	
Comparative tracking index	CTI		600	
Application example		V	600 V CAT III, PD2	Reinforced insulation, non uniform field according to IEC 61800-5-1
Application example		V	1000 V CAT III, PD2	Basic insulation, non uniform field according to IEC 61800-5-1

Environmental and mechanical characteristics

Parameter	Symbol	Unit	Min	Typ	Max	Comment
Ambient operating temperature	T_A	$^{\circ}$ C	-40		105	
Ambient storage temperature	T_S	$^{\circ}$ C	-55		125	
Mass	m	g		10		

Electrical data LKSR 6-NP

At $T_A = 25\text{ °C}$, $U_C = +5\text{ V}$, $N_P = 1\text{ turn}$, $R_L = 10\text{ k}\Omega$ internal reference, unless otherwise noted (see Definition of typical, minimum and maximum values paragraph in page 18).

Parameter	Symbol	Unit	Min	Typ	Max	Comment
Primary nominal RMS current	I_{PN}	A		6		Apply derating according to fig. 21
Primary current, measuring range	I_{PM}	A	-20		20	
Number of primary turns	N_P			1, 2, 3, 4		
Supply voltage	U_C	V	4.75	5	5.25	
Current consumption	I_C	mA		$17 + \frac{I_s(\text{mA})}{N_s}$	$20 + \frac{I_s(\text{mA})}{N_s}$	$N_s = 2000\text{ turns}$
Reference voltage @ $I_P = 0\text{ A}$	V_{ref}	V	2.485	2.5	2.515	Internal reference
External reference voltage	V_{ref}	V	0.5		2.75	
Output voltage	V_{out}	V	0.25		4.75	with $U_C = +5\text{ V}$
Output voltage @ $I_P = 0\text{ A}$	V_{out}	V		V_{ref}		
Electrical offset voltage	V_{OE}	mV	-5		5	100 % tested $V_{out} - V_{ref}$
Electrical offset current referred to primary	I_{OE}	mA	-48		48	100 % tested
Temperature coefficient of V_{ref} @ $I_P = 0\text{ A}$	TCV_{ref}	ppm/K			± 70	Internal reference
Temperature coefficient of V_{out} @ $I_P = 0\text{ A}$	TCV_{out}	ppm/K			± 14	ppm/K of 2.5 V -40 °C ... 105 °C
Theoretical sensitivity	G_{th}	mV/A		104.2		$625\text{ mV}/I_{PN}$
Sensitivity error	ε_G	%	-0.2		0.2	100 % tested
Temperature coefficient of G	TCG	ppm/K			± 40	-40 °C ... 105 °C
Linearity error	ε_L	% of I_{PN}	-0.1		0.1	
Magnetic offset current ($10 \times I_{PN}$) referred to primary	I_{OM}	mA	-25		25	
Output RMS voltage noise spectral density 100 ... 100 kHz referred to primary	e_{no}	$\mu\text{V}/\text{Hz}^{1/2}$		7		
Output voltage noise DC ... 10 kHz DC ... 100 kHz DC ... 1 MHz	V_{no}	mVpp		10.5 13.4 13.6		
Reaction time @ 10 % of I_{PN}	t_{ra}	μs			0.3	$R_L = 1\text{ k}\Omega$, $di/dt = 50\text{ A}/\mu\text{s}$
Step response time to 90 % of I_{PN}	t_r	μs			0.4	$R_L = 1\text{ k}\Omega$, $di/dt = 50\text{ A}/\mu\text{s}$
Frequency bandwidth ($\pm 1\text{ dB}$)	BW	kHz	300			$R_L = 1\text{ k}\Omega$
Overall accuracy	X_G	% of I_{PN}			1.25	
Overall accuracy @ $T_A = 85\text{ °C}$ (105 °C)	X_G	% of I_{PN}			1.25 (1.5)	
Accuracy	X	% of I_{PN}			0.5	
Accuracy @ $T_A = 85\text{ °C}$ (105 °C)	X	% of I_{PN}			0.75 (1)	

Electrical data LKSR 15-NP

At $T_A = 25\text{ °C}$, $U_C = +5\text{ V}$, $N_P = 1\text{ turn}$, $R_L = 10\text{ k}\Omega$ internal reference, unless otherwise noted (see Definition of typical, minimum and maximum values paragraph in page 18).

Parameter	Symbol	Unit	Min	Typ	Max	Comment
Primary nominal RMS current	I_{PN}	A		15		Apply derating according to fig. 22
Primary current, measuring range	I_{PM}	A	-51		51	
Number of primary turns	N_P			1, 2, 3, 4		
Supply voltage	U_C	V	4.75	5	5.25	
Current consumption	I_C	mA		$17 + \frac{I_s(\text{mA})}{N_s}$	$20 + \frac{I_s(\text{mA})}{N_s}$	$N_s = 2000\text{ turns}$
Reference voltage @ $I_P = 0\text{ A}$	V_{ref}	V	2.485	2.5	2.515	Internal reference
External reference voltage	V_{ref}	V	0.5		2.75	
Output voltage	V_{out}	V	0.25		4.75	with $U_C = +5\text{ V}$
Output voltage @ $I_P = 0\text{ A}$	V_{out}	V		V_{ref}		
Electrical offset voltage	V_{OE}	mV	-1.75		1.75	100 % tested $V_{out} - V_{ref}$
Electrical offset current referred to primary	I_{OE}	mA	-42		42	100 % tested
Temperature coefficient of V_{ref} @ $I_P = 0\text{ A}$	TCV_{ref}	ppm/K			± 70	Internal reference
Temperature coefficient of V_{out} @ $I_P = 0\text{ A}$	TCV_{out}	ppm/K			± 6	ppm/K of 2.5 V -40 °C ... 105 °C
Theoretical sensitivity	G_{th}	mV/A		41.67		$625\text{ mV}/I_{PN}$
Sensitivity error	ε_G	%	-0.2		0.2	100 % tested
Temperature coefficient of G	TCG	ppm/K			± 40	-40 °C ... 105 °C
Linearity error	ε_L	% of I_{PN}	-0.1		0.1	
Magnetic offset current ($10 \times I_{PN}$) referred to primary	I_{OM}		-45		45	
Output RMS voltage noise spectral density 100 ... 100 kHz referred to primary	e_{no}	$\mu\text{V}/\text{Hz}^{1/2}$		3.5		
Output voltage noise DC ... 10 kHz DC ... 100 kHz DC ... 1 MHz	V_{no}	mVpp		4.5 5.7 6.3		
Reaction time @ 10 % of I_{PN}	t_{ra}	μs			0.3	$R_L = 1\text{ k}\Omega$, $di/dt = 50\text{ A}/\mu\text{s}$
Step response time to 90 % of I_{PN}	t_r	μs			0.4	$R_L = 1\text{ k}\Omega$, $di/dt = 50\text{ A}/\mu\text{s}$
Frequency bandwidth ($\pm 3\text{ dB}$)	BW	kHz	300			$R_L = 1\text{ k}\Omega$
Overall accuracy	X_G	% of I_{PN}			0.75	
Overall accuracy @ $T_A = 85\text{ °C}$ (105 °C)	X_G	% of I_{PN}			0.75 (1)	
Accuracy	X	% of I_{PN}			0.5	
Accuracy @ $T_A = 85\text{ °C}$ (105 °C)	X	% of I_{PN}			0.65 (0.75)	

Electrical data LKSR 25-NP

At $T_A = 25\text{ °C}$, $U_C = +5\text{ V}$, $N_P = 1\text{ turn}$, $R_L = 10\text{ k}\Omega$ internal reference, unless otherwise noted (see Definition of typical, minimum and maximum values paragraph in page 18).

Parameter	Symbol	Unit	Min	Typ	Max	Comment
Primary nominal RMS current	I_{PN}	A		25		Apply derating according to fig. 23
Primary current, measuring range	I_{PM}	A	-85		85	
Number of primary turns	N_P			1, 2, 3, 4		
Supply voltage	U_C	V	4.75	5	5.25	
Current consumption	I_C	mA		$17 + \frac{I_p(\text{mA})}{N_s}$	$20 + \frac{I_p(\text{mA})}{N_s}$	$N_s = 2000\text{ turns}$
Reference voltage @ $I_P = 0\text{ A}$	V_{ref}	V	2.485	2.5	2.515	Internal reference
External reference voltage	V_{ref}	V	0.5		2.75	
Output voltage	V_{out}	V	0.25		4.75	with $U_C = +5\text{ V}$
Output voltage @ $I_P = 0\text{ A}$	V_{out}	V		V_{ref}		
Electrical offset voltage	V_{OE}	mV	-1		1	100 % tested $V_{out} - V_{ref}$
Electrical offset current referred to primary	I_{OE}	mA	-40		40	100 % tested
Temperature coefficient of V_{ref} @ $I_P = 0\text{ A}$	TCV_{ref}	ppm/K			± 70	Internal reference
Temperature coefficient of V_{out} @ $I_P = 0\text{ A}$	TCV_{out}	ppm/K			± 4	ppm/K of 2.5 V -40 °C ... 105 °C
Theoretical sensitivity	G_{th}	mV/A		25		$625\text{ mV}/I_{PN}$
Sensitivity error	ε_G	%	-0.2		0.2	100 % tested
Temperature coefficient of G	TCG	ppm/K			± 40	-40 °C ... 105 °C
Linearity error	ε_L	% of I_{PN}	-0.1		0.1	
Magnetic offset current ($10 \times I_{PN}$) referred to primary	I_{OM}	mA	-60		60	
Output RMS voltage noise spectral density 100 ... 100 kHz referred to primary	e_{no}	$\mu\text{V}/\text{Hz}^{1/2}$		1.8		
Output voltage noise DC ... 10 kHz DC ... 100 kHz DC ... 1 MHz	V_{no}	mVpp		2.6 3.9 5.1		
Reaction time @ 10 % of I_{PN}	t_{ra}	μs			0.3	$R_L = 1\text{ k}\Omega$, $di/dt = 50\text{ A}/\mu\text{s}$
Step response time to 90 % of I_{PN}	t_r	μs			0.4	$R_L = 1\text{ k}\Omega$, $di/dt = 50\text{ A}/\mu\text{s}$
Frequency bandwidth ($\pm 3\text{ dB}$)	BW	kHz	300			$R_L = 1\text{ k}\Omega$
Overall accuracy	X_G	% of I_{PN}			0.8	
Overall accuracy @ $T_A = 85\text{ °C}$ (105 °C)	X_G	% of I_{PN}			0.85 (0.9)	
Accuracy	X	% of I_{PN}			0.5	
Accuracy @ $T_A = 85\text{ °C}$ (105 °C)	X	% of I_{PN}			0.65 (0.75)	

Electrical data LKSR 50-NP

At $T_A = 25\text{ °C}$, $U_C = +5\text{ V}$, $N_p = 1\text{ turn}$, $R_L = 10\text{ k}\Omega$ internal reference, unless otherwise noted (see Definition of typical, minimum and maximum values paragraph in page 18).

Parameter	Symbol	Unit	Min	Typ	Max	Comment
Primary nominal RMS current	I_{PN}	A		50		Apply derating according to fig. 24
Primary current, measuring range	I_{PM}	A	-150		150	
Number of primary turns	N_p			1, 2, 3, 4		
Supply voltage	U_C	V	4.75	5	5.25	
Current consumption	I_C	mA		$17 + \frac{I_p(\text{mA})}{N_s}$	$20 + \frac{I_p(\text{mA})}{N_s}$	$N_s = 1600\text{ turns}$
Reference voltage @ $I_p = 0\text{ A}$	V_{ref}	V	2.485	2.5	2.515	Internal reference
External reference voltage	V_{ref}	V	0.5		2.75	
Output voltage	V_{out}	V	0.25		4.75	with $U_C = +5\text{ V}$
Output voltage @ $I_p = 0\text{ A}$	V_{out}	V		V_{ref}		
Electrical offset voltage	V_{OE}	mV	-0.7		0.7	100 % tested $V_{out} - V_{ref}$
Electrical offset current referred to primary	I_{OE}	mA	-56		56	100 % tested
Temperature coefficient of V_{ref} @ $I_p = 0\text{ A}$	TCV_{ref}	ppm/K			± 70	Internal reference
Temperature coefficient of V_{out} @ $I_p = 0\text{ A}$	TCV_{out}	ppm/K			± 3	ppm/K of 2.5 V -40 °C ... 105 °C
Theoretical sensitivity	G_{th}	mV/A		12.5		$625\text{ mV}/I_{PN}$
Sensitivity error	ϵ_G	%	-0.2		0.2	100 % tested
Temperature coefficient of G	TCG	ppm/K			± 40	-40 °C ... 105 °C
Linearity error	ϵ_L	% of I_{PN}	-0.1		0.1	
Magnetic offset current ($10 \times I_{PN}$) referred to primary	I_{OM}	mA	-60		60	
Output RMS voltage noise spectral density 100 ... 100 kHz referred to primary	e_{no}	$\mu\text{V}/\text{Hz}^{1/2}$		1.7		
Output voltage noise DC ... 10 kHz DC ... 100 kHz DC ... 1 MHz	V_{no}	mVpp		2.4 3.2 4.8		
Reaction time @ 10 % of I_{PN}	t_{ra}	μs			0.3	$R_L = 1\text{ k}\Omega$, $di/dt = 50\text{ A}/\mu\text{s}$
Step response time to 90 % of I_{PN}	t_r	μs			0.4	$R_L = 1\text{ k}\Omega$, $di/dt = 50\text{ A}/\mu\text{s}$
Frequency bandwidth ($\pm 3\text{ dB}$)	BW	kHz	300			$R_L = 1\text{ k}\Omega$
Overall accuracy	X_G	% of I_{PN}			0.7	
Overall accuracy @ $T_A = 85\text{ °C}$ (105 °C)	X_G	% of I_{PN}			0.7 (0.8)	
Accuracy	X	% of I_{PN}			0.5	
Accuracy @ $T_A = 85\text{ °C}$ (105 °C)	X	% of I_{PN}			0.65 (0.75)	

Typical performance characteristics LKSR 6-NP

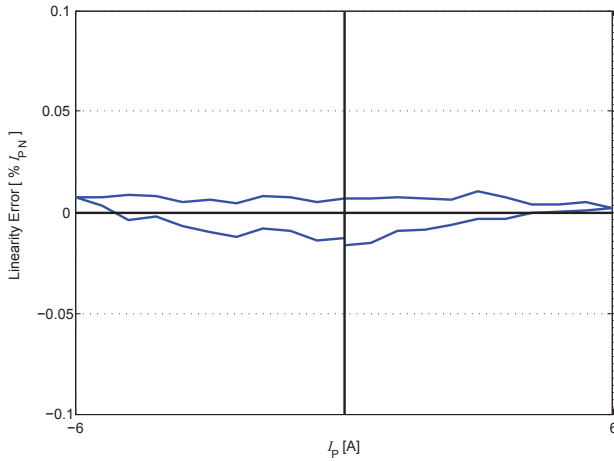

Figure 1: Linearity error

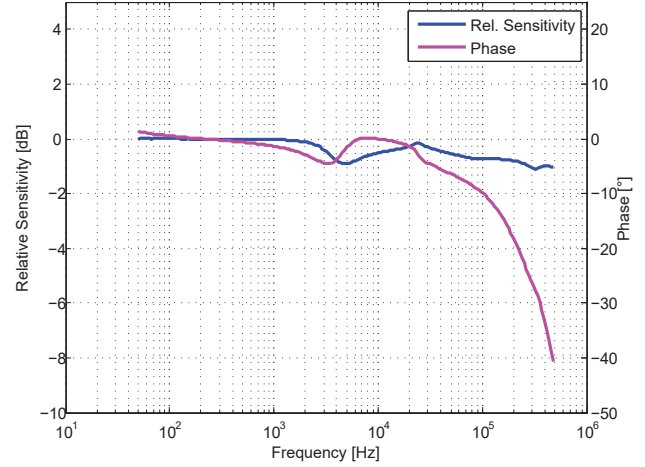

Figure 2: Frequency response

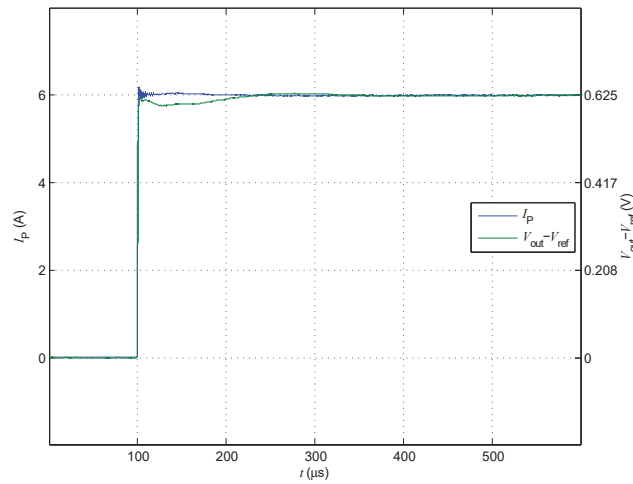

Figure 3: Step response

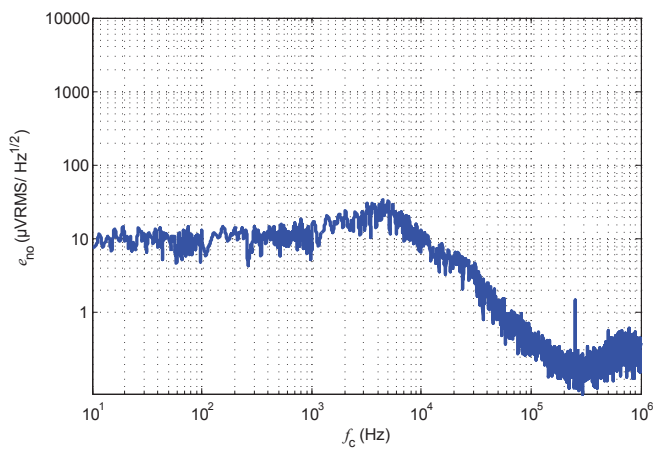

Figure 4: Output noise voltage spectral density

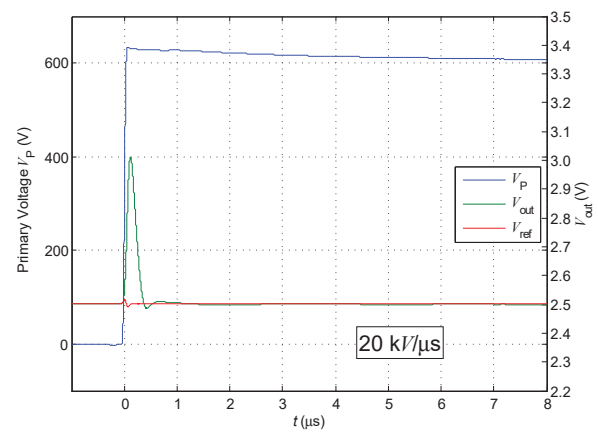

Figure 5: dv/dt

Typical performance characteristics LKSR 15-NP

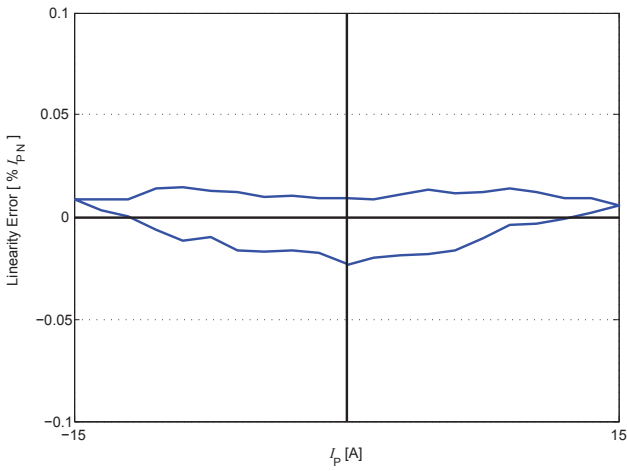

Figure 6: Linearity error

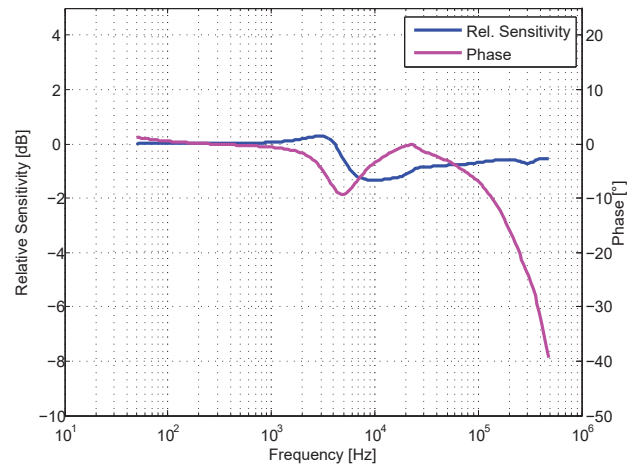

Figure 7: Frequency response

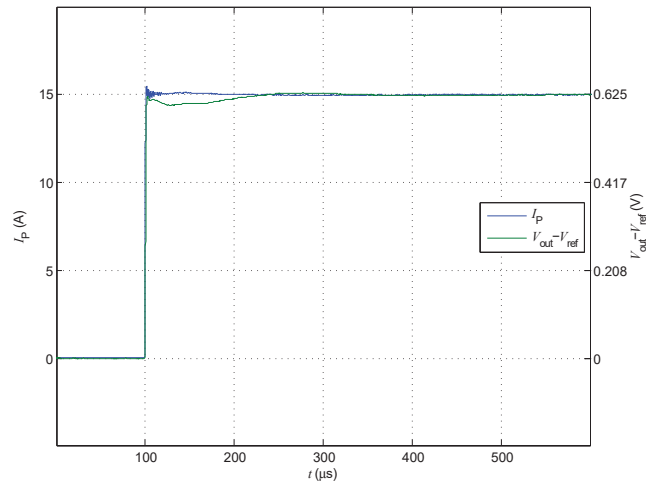

Figure 8: Step response

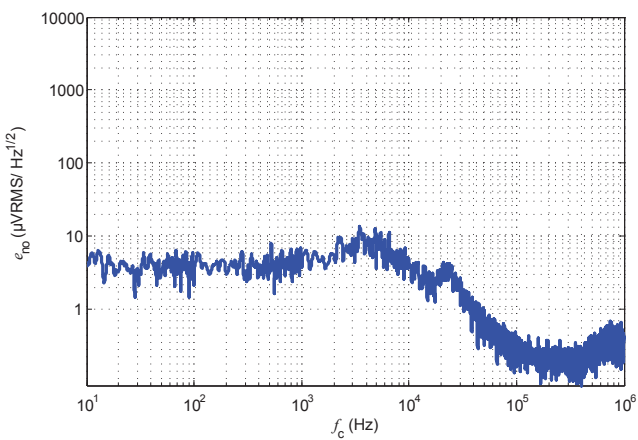

Figure 9: Output noise voltage spectral density

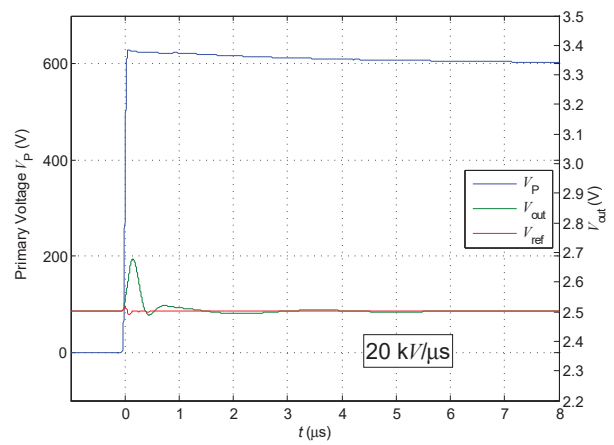

Figure 10: dv/dt

Typical performance characteristics LKSR 25-NP

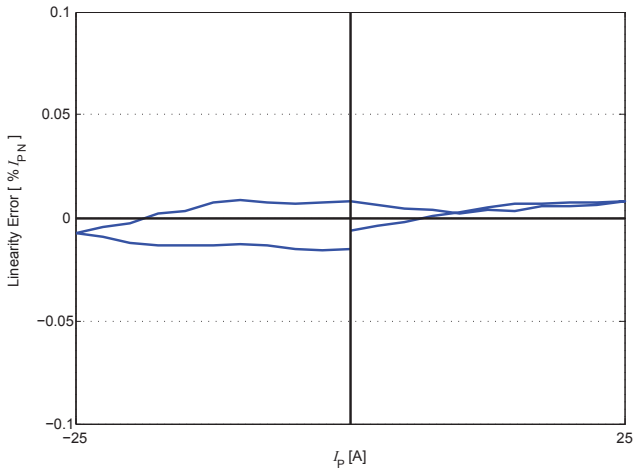

Figure 11: Linearity error

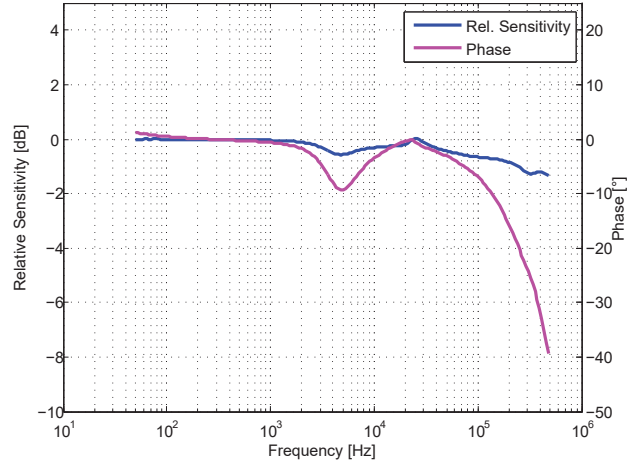

Figure 12: Frequency response

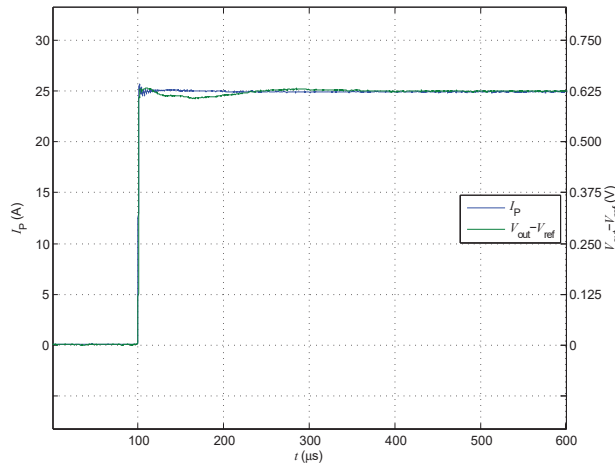

Figure 13: Step response

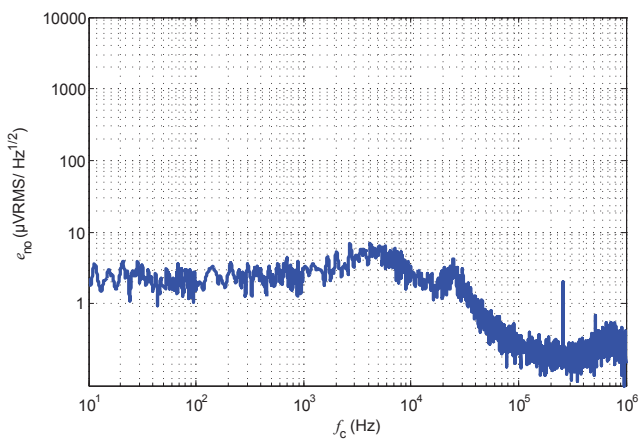

Figure 14: Output noise voltage spectral density

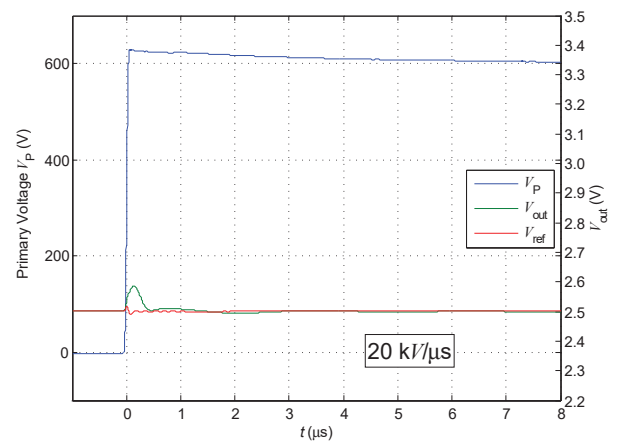

Figure 15: dv/dt

Typical performance characteristics LKSR 50-NP

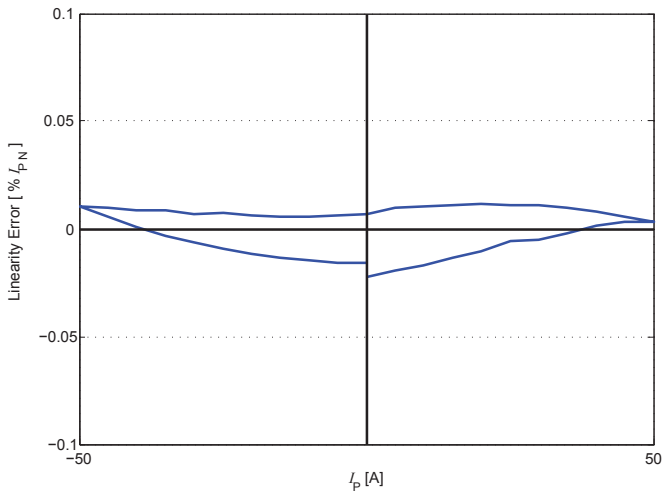

Figure 16: Linearity error

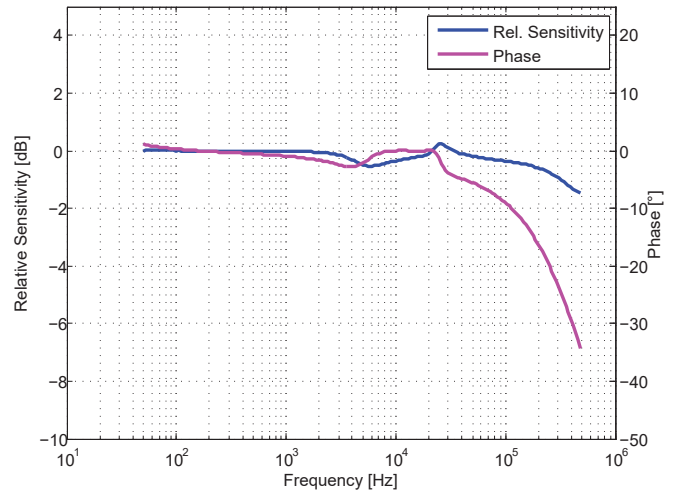

Figure 17: Frequency response

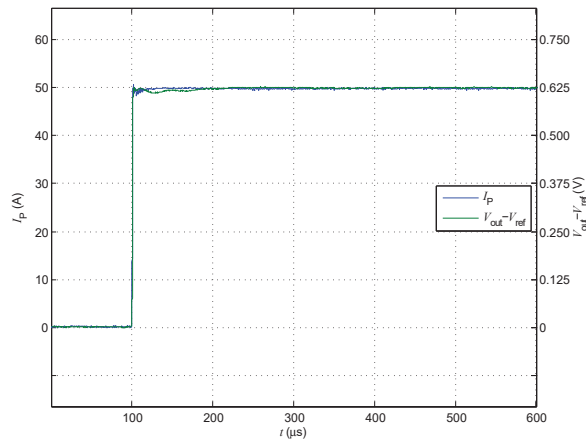

Figure 18: Step response

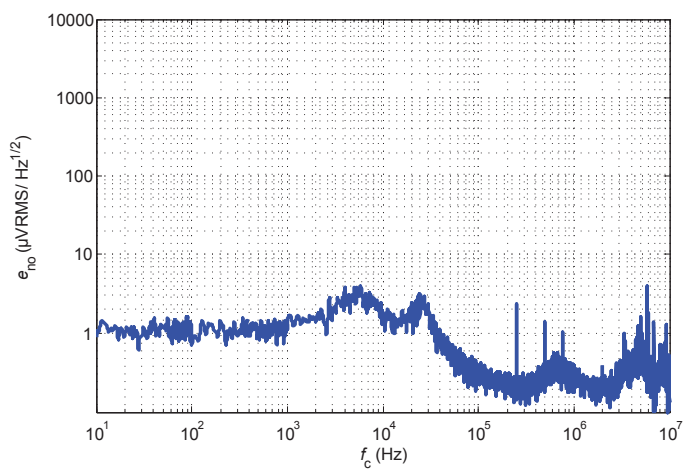

Figure 19: Output noise voltage spectral density

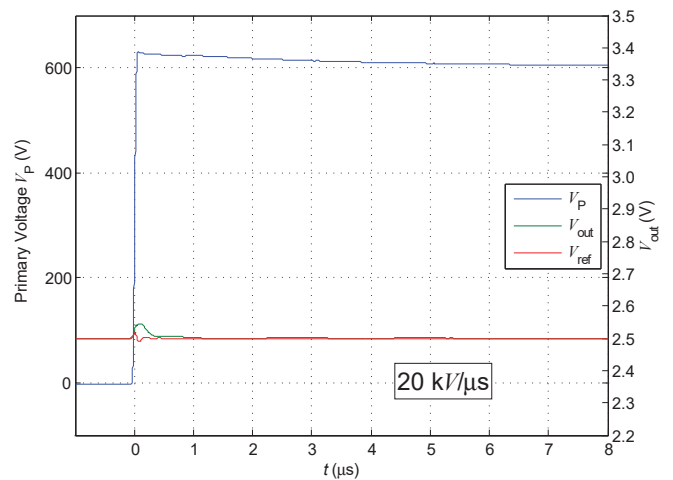

Figure 20: dv/dt

Maximum continuous DC primary current

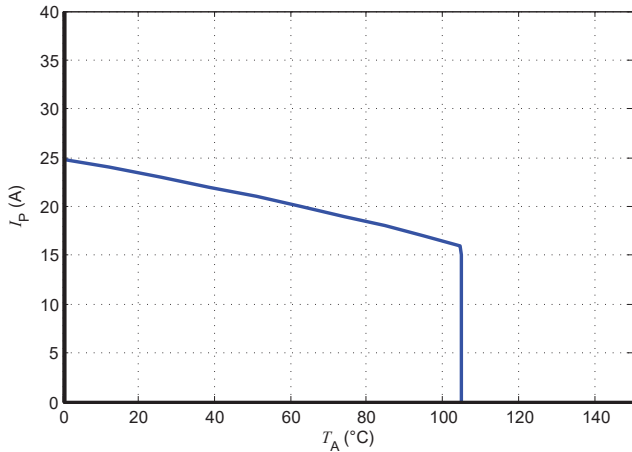

Figure 21: I_p vs T_A for LKSR 6-NP

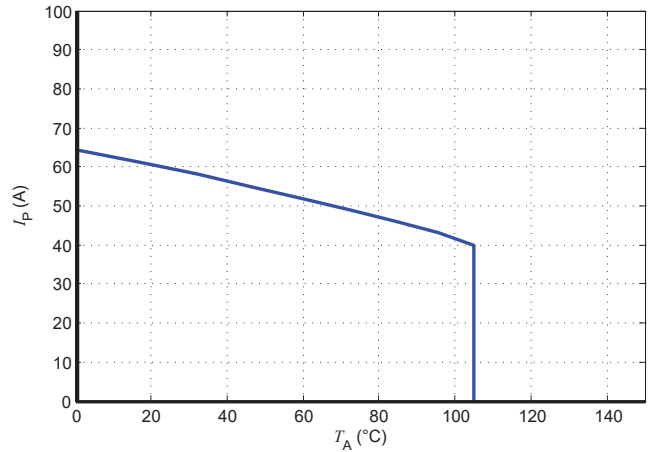

Figure 22: I_p vs T_A for LKSR 15-NP

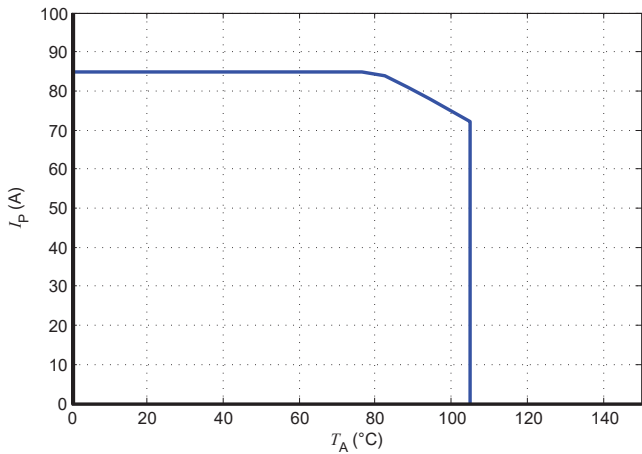

Figure 23: I_p vs T_A for LKSR 25-NP

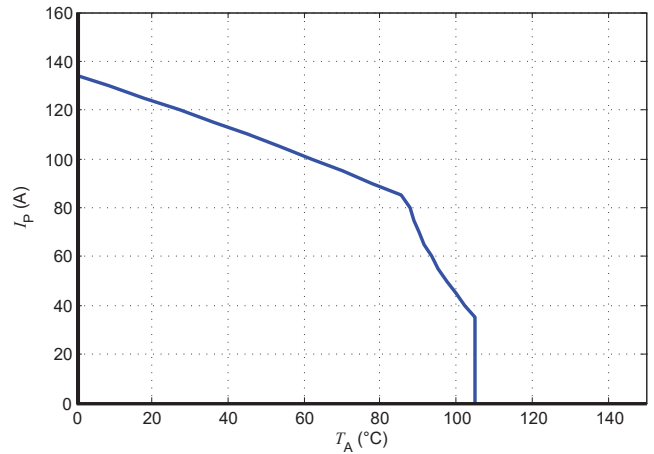

Figure 24: I_p vs T_A for LKSR 50-NP

The maximum continuous DC primary current plot shows the boundary of the area for which all the following conditions are true:

- $I_p < I_{PM}$
- Junction temperature $T_j < 125$ °C
- Primary conductor temperature < 110 °C
- Max power dissipation of internal resistors $< 0.5 \times$ resistors nominal power

Frequency derating

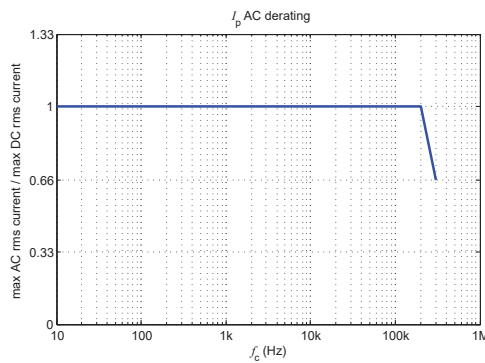

Figure 25: Maximum RMS AC primary current / maximum DC primary current vs frequency

Performance parameters definition

Ampere-turns and amperes

The transducer is sensitive to the primary current linkage θ_p (also called ampere-turns).

$$\theta_p = N_p \cdot I_p \text{ (At)}$$

Where N_p is the number of primary turn (depending on the connection of the primary jumpers)

Caution: As most applications will use the transducer with only one single primary turn ($N_p = 1$), much of this datasheet is written in terms of primary current instead of current linkages. However, the ampere-turns (At) unit is used to emphasize that current linkages are intended and applicable.

Transducer simplified model

The static model of the transducer at temperature T_A is:

$$V_{out} = G \cdot \theta_p + \varepsilon$$

In which $\varepsilon =$

$$V_{OE} + V_{OT}(T_A) + \varepsilon_G \cdot \theta_p \cdot G + \varepsilon_L(\theta_{Pmax}) \cdot \theta_{Pmax} \cdot G + TCG \cdot (T_A - 25) \cdot \theta_p \cdot G$$

- With:
- $\theta_p = N_p \cdot I_p$: primary current linkage (At)
 - θ_{Pmax} : max primary current linkage applied to the transducer
 - I_S : secondary current (A)
 - T_A : ambient operating temperature ($^{\circ}\text{C}$)
 - I_{OE} : electrical offset current (A)
 - $I_{OT}(T_A)$: temperature variation of I_o at temperature T_A ($^{\circ}\text{C}$)
 - G : sensitivity of the transducer (V/At)
 - TCG : temperature coefficient of G
 - ε_G : sensitivity error
 - $\varepsilon_L(\theta_{Pmax})$: linearity error for θ_{Pmax}

This model is valid for primary ampere-turns θ_p between $-\theta_{Pmax}$ and $+\theta_{Pmax}$ only.

Sensitivity and linearity

To measure sensitivity and linearity, the primary current (DC) is cycled from 0 to I_{P1} then to $-I_{P1}$ and back to 0 (equally spaced $I_P/10$ steps). The sensitivity G is defined as the slope of the linear regression line for a cycle between $\pm I_{P1}$.

The linearity error ε_L is the maximum positive or negative difference between the measured points and the linear regression line, expressed in % of I_{P1} .

Magnetic offset

The magnetic offset current I_{OM} is the consequence of a current on the primary side ("memory effect" of the transducer's ferro-magnetic parts). It is measured using the following primary current cycle. I_{OM} depends on the current value I_{P1} ($I_{P1} > I_{PM}$).

$$I_{OM} = \frac{V_{out}(t_1) - V_{out}(t_2)}{2} \cdot \frac{1}{G_{\#}}$$

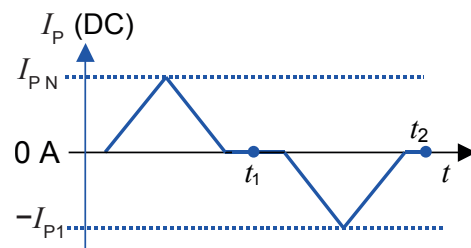

Figure 26: Current cycle used to measure magnetic and electrical offset (transducer supplied)

Performance parameters definition

Electrical offset

The electrical offset voltage V_{OE} can either be measured when the ferro-magnetic parts of the transducer are:

- Completely demagnetized, which is difficult to realize,
- or in a known magnetization state, like in the current cycle shown in figure 26.

Using the current cycle shown in figure 26, the electrical offset is:

$$V_{OE} = \frac{V_{out}(t_1) + V_{out}(t_2)}{2}$$

The temperature variation V_{OT} of the electrical offset voltage V_{OE} is the variation of the electrical offset from 25 °C to the considered temperature:

$$V_{OT}(T) = V_{OE}(T) - V_{OE}(25^\circ\text{C})$$

Note: the transducer has to be demagnetized prior to the application of the current cycle (for example with a demagnetization tunnel).

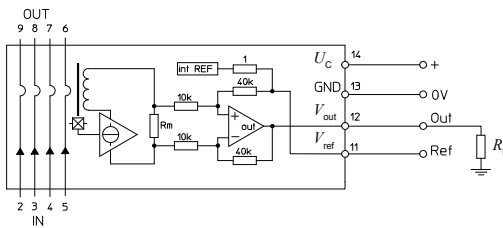

Figure 27: Test connection

Overall accuracy

The overall accuracy at 25 °C X_G is the error in the $-I_{PN} \dots +I_{PN}$ range, relative to the rated value I_{PN} .

It includes:

- the electrical offset V_{OE}
- the sensitivity error ϵ_G
- the linearity error ϵ_L (to I_{PN})

Response and reaction times

The response time t_r and the reaction time t_{ra} are shown in figure 28.

Both depend on the primary current di/dt . They are measured at nominal ampere-turns.

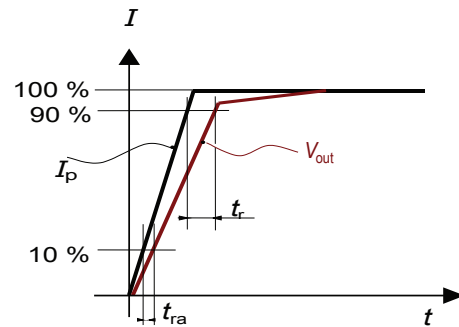

Figure 28: Response time t_r and reaction time t_{ra}

Application information

Filtering and decoupling

Supply voltage U_C

The transducer has internal decoupling capacitors, but in the case of a power supply with high impedance, it is highly recommended to provide local decoupling (100 nF or more, located close to the transducer) as it may reduce disturbance on transducer output V_{out} and reference V_{ref} due to high varying primary current. The transducer power supply rejection ratio is low at high frequency.

Output V_{out}

The output V_{out} has a very low output impedance of typically 1 Ohm; it can drive capacitive loads of up to 100 nF directly. Adding series resistance R_f of several tenths of Ohms allows much larger capacitive loads C_f (higher than 1 μ F). Empirical evaluation may be necessary to obtain optimum results. The minimum load resistance on V_{out} is 1 kOhm.

Total Primary Resistance

The primary resistance is 0.72 m Ω per conductor.

In the following table, examples of primary resistance according to the number of primary turns.

Number of primary turns	Primary Nominal RMS current	Output voltage V_{out}	Primary resistance R_P [m Ω]	Recommended connections
1	$\pm I_{PN}$	$V_{ref} \pm 0.625$	0.18	
2	$\pm I_{PN}/2$	$V_{ref} \pm 0.625$	0.72	
3	$\pm I_{PN}/3$	$V_{ref} \pm 0.625$	1.8	
4	$\pm I_{PN}/4$	$V_{ref} \pm 0.625$	2.88	

Reference V_{ref}

Likewise output V_{out} , the V_{ref} has a very low output impedance of typically 1 Ohm; it can drive capacitive loads of up to 100 nF directly. Adding series resistance R_f of several tenths of Ohms allows much larger capacitive loads C_f (higher than 1 μ F). Empirical evaluation may be necessary to obtain optimum results. The minimum load resistance on V_{ref} is 10 kOhms.

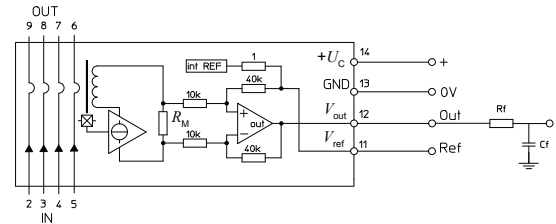

Figure 29: filtered V_{out} connection

External reference voltage

The REF pin can be used either as a reference voltage output or as a reference voltage input. When used in reference voltage output, the internal reference voltage V_{ref} is used by the transducer as the reference point for bipolar measurements.

The internal reference voltage output accuracy is defined in the electrical parameter data.

When used in reference voltage input, an external reference voltage is connected to the REF pin.

In this case, the maximum allowable reference voltage range is 0.5 V - 2.75 V.

The REF pin must be able to source or sink an input current of maximum 1.5 mA.

If the reference voltage is not used, the REF pin should be left unconnected.

The following graphs show how the measuring range of each transducer version depends on the external reference voltage value V_{ref} .

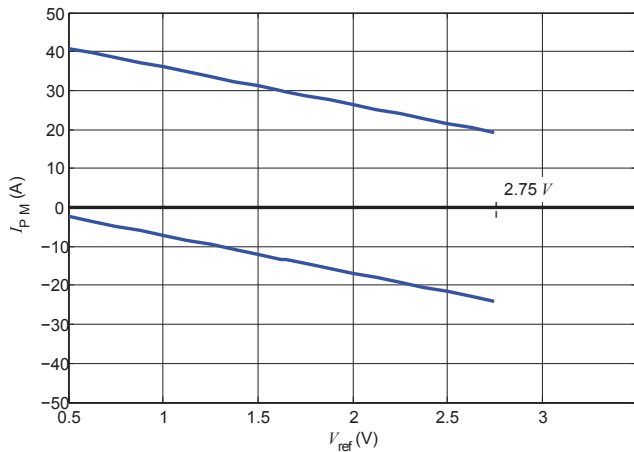

Figure 30: Measuring range versus external V_{ref} LKSR 6 A

Upper limit: $I_p = -9.6 * V_{ref} + 45.6$ ($V_{ref} = 0.5 \dots 2.75$ V)

Lower limit: $I_p = -9.6 * V_{ref} + 2.4$ ($V_{ref} = 0.5 \dots 2.75$ V)

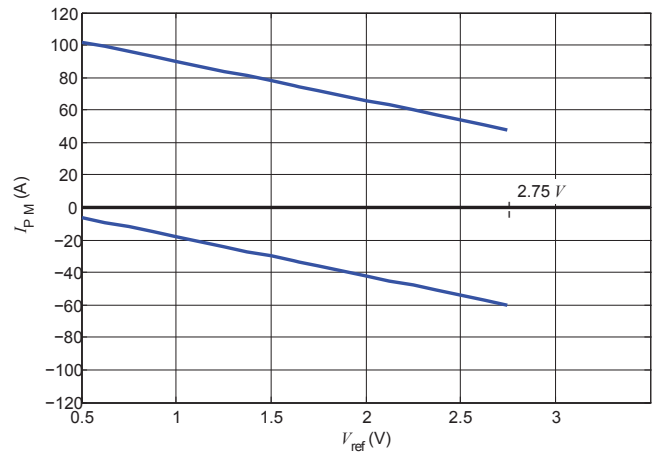

Figure 31: Measuring range versus external V_{ref} LKSR 15 A

Upper limit: $I_p = -24 * V_{ref} + 114$ ($V_{ref} = 0.5 \dots 2.75$ V)

Lower limit: $I_p = -24 * V_{ref} + 6$ ($V_{ref} = 0 \dots 2.75$ V)

External reference voltage

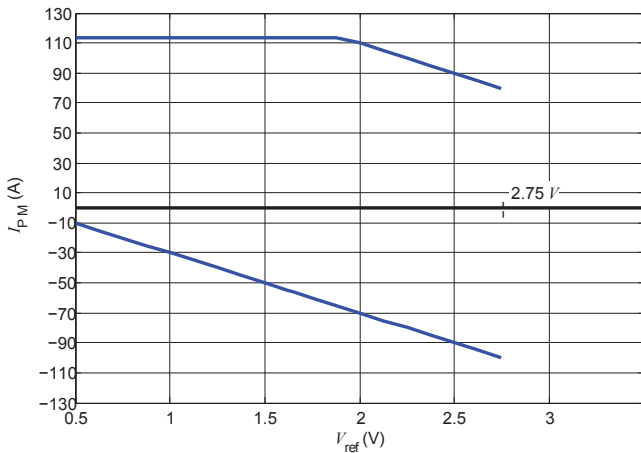

Figure 32: Measuring range versus external V_{ref} LKSR 25 A

Upper limit: $I_p = -40 * V_{ref} + 190$ ($V_{ref} = 1.85 \dots 2.75$ V)
 Upper limit: $I_p = 113$ ($V_{ref} = 0 \dots 1.85$ V)
 Lower limit: $I_p = -40 * V_{ref} + 10$ ($V_{ref} = 0 \dots 2.75$ V)

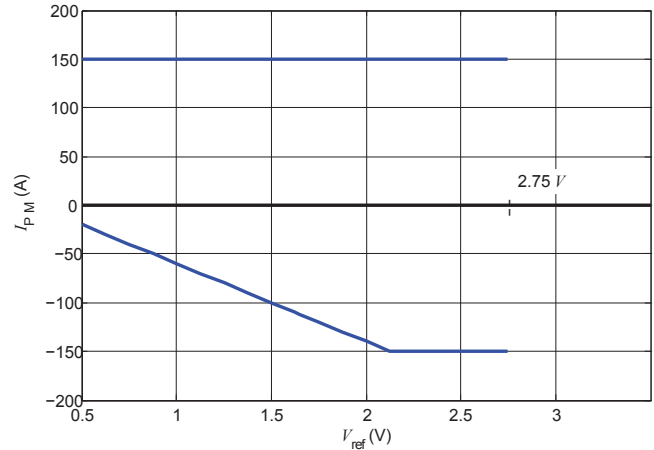

Figure 33: Measuring range versus external V_{ref} LKSR 50 A

Upper limit: $I_p = 150$ ($V_{ref} = 0 \dots 2.75$ V)
 Lower limit: $I_p = -80 * V_{ref} + 20$ ($V_{ref} = 0 \dots 2.125$ V)
 Lower limit: $I_p = -150$ ($V_{ref} = 2.125 \dots 2.75$ V)

Example with $V_{ref} = 1.65$ V:

- The 6 A version has a measuring range from -13.44 A to +29.76 A
- The 15 A version has a measuring range from -33.6 A to +74.4 A
- The 25 A version has a measuring range from -56 A to +113 A
- The 50 A version has a measuring range from -112 A to +150 A

Example with $V_{ref} = 0.5$ V:

- The 6 A version has a measuring range from -2.4 A to +40.8 A
- The 15 A version has a measuring range from -6 A to +102 A
- The 25 A version has a measuring range from -10 A to +113 A
- The 50 A version has a measuring range from -20 A to +150 A

PCB footprint

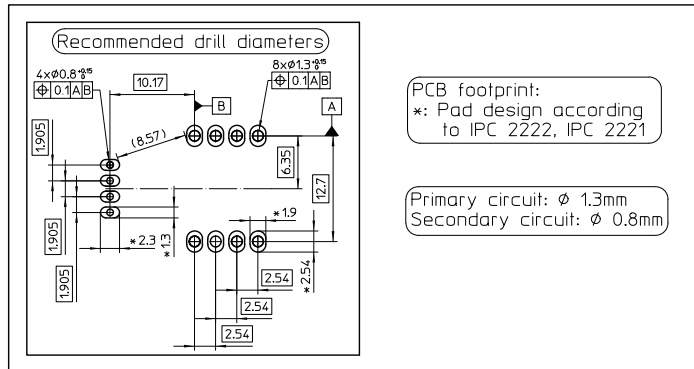

Assembly on PCB

- Recommended PCB hole diameter 1.3 mm for primary pin
0.8 mm for secondary pin
- Maximum PCB thickness 2.4 mm
- Wave soldering profile maximum 260 °C for 10 s
No clean process only

Safety

This transducer must be used in limited-energy typical secondary circuits according to IEC 61010-1.



This transducer must be used in electric/electronic equipment with respect to applicable standards and safety requirements in accordance with the manufacturer's operating instructions.

Caution, risk of electrical shock



When operating the transducer, certain parts of the module can carry hazardous voltage (e.g. primary busbar, power supply). Ignoring this warning can lead to injury and/or cause serious damage.

This transducer is a build-in device, whose conducting parts must be inaccessible after installation.

A protective housing or additional shield could be used. Main supply must be able to be disconnected.

Remark

Installation of the transducer must be done unless otherwise specified on the datasheet, according to LEM Transducer Generic Mounting Rules. Please refer to LEM document N°ANE120504 available on our Web site: [Products/Product Documentation](#).

Definition of typical, minimum and maximum values

Minimum and maximum values for specified limiting and safety conditions have to be understood as such as well as values shown in "typical" graphs.

On the other hand, measured values are part of a statistical distribution that can be specified by an interval with upper and lower limits and a probability for measured values to lie within this interval.

Unless otherwise stated (e.g. "100 % tested"), the LEM definition for such intervals designated with "min" and "max" is that the probability for values of samples to lie in this interval is 99.73 %.

For a normal (Gaussian) distribution, this corresponds to an interval between -3 sigma and $+3$ sigma. If "typical" values are not obviously mean or average values, those values are defined to delimit intervals with a probability of 68.27 %, corresponding to an interval between $-\text{sigma}$ and $+\text{sigma}$ for a normal distribution.

Typical, maximal and minimal values are determined during the initial characterization of the product.

Dimensions (in mm)

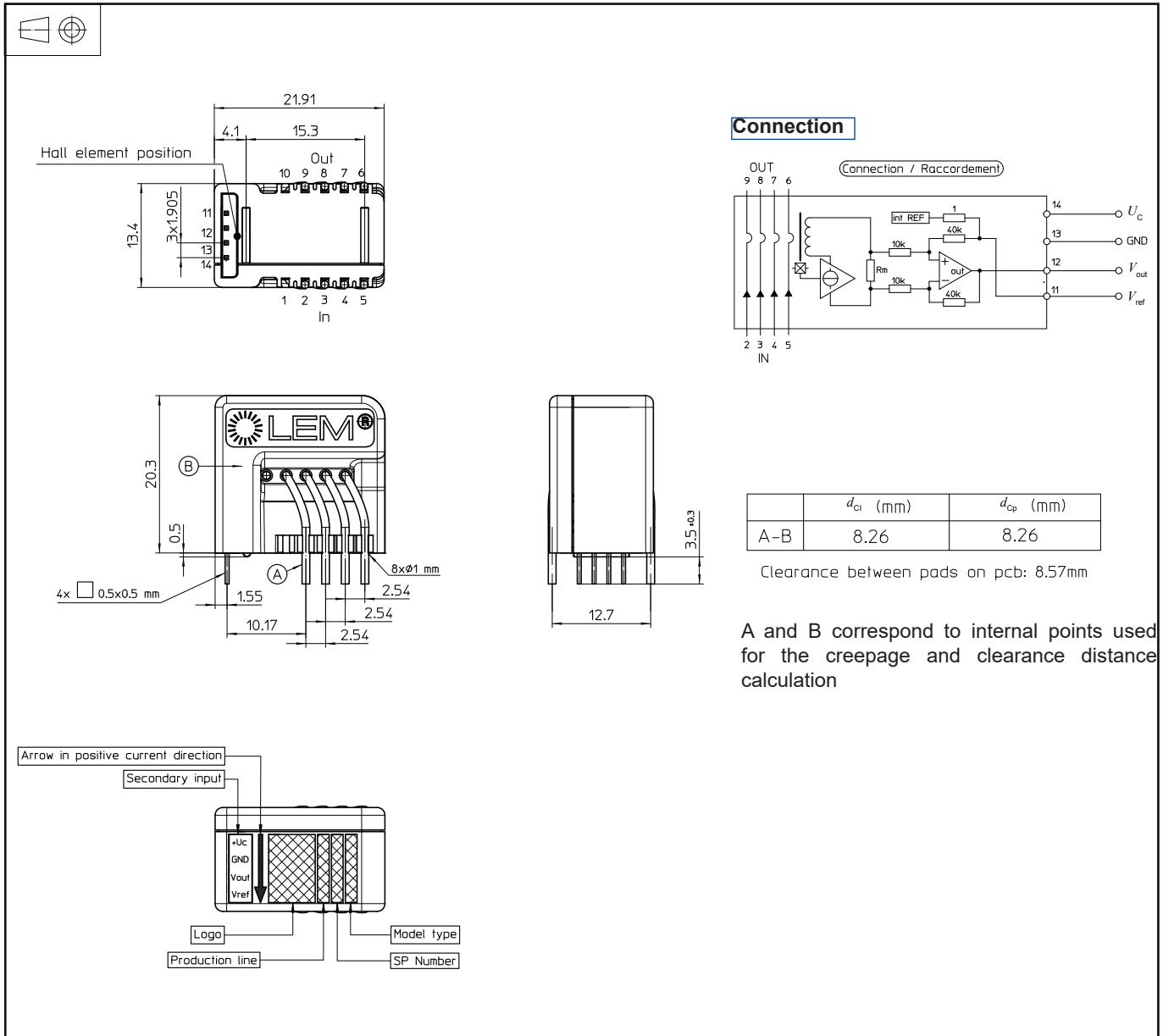

Packaging information

Standard delivery in cardboard: L × W × H: 315 × 200 × 120 mm

Each cardboard contains 200 parts, placed into 4 Polystyrene-made trays of 50 parts each one.

Both trays and cardboard are ESD-compliant.

The typical weight of the cardboard is 2.5 Kg.

