



Chipsmall Limited consists of a professional team with an average of over 10 year of expertise in the distribution of electronic components. Based in Hongkong, we have already established firm and mutual-benefit business relationships with customers from,Europe,America and south Asia,supplying obsolete and hard-to-find components to meet their specific needs.

With the principle of “Quality Parts,Customers Priority,Honest Operation,and Considerate Service”,our business mainly focus on the distribution of electronic components. Line cards we deal with include Microchip,ALPS,ROHM,Xilinx,Pulse,ON,Everlight and Freescale. Main products comprise IC,Modules,Potentiometer,IC Socket,Relay,Connector.Our parts cover such applications as commercial,industrial, and automotives areas.

We are looking forward to setting up business relationship with you and hope to provide you with the best service and solution. Let us make a better world for our industry!



Contact us

Tel: +86-755-8981 8866 Fax: +86-755-8427 6832

Email & Skype: info@chipsmall.com Web: www.chipsmall.com

Address: A1208, Overseas Decoration Building, #122 Zhenhua RD., Futian, Shenzhen, China



1.4MHz, 1.5A ASYNCHRONOUS DC-DC BUCK CONVERTER AP3211

General Description

The AP3211 is a 1.4MHz fixed frequency, current mode, PWM buck (step-down) DC-DC converter, capable of driving a 1.5A load with high efficiency, excellent line and load regulation. The device integrates N-channel power MOSFET switch with low on-resistance. Current mode control provides fast transient response and cycle-by-cycle current limit.

A standard series of inductors are available from several different manufacturers optimized for use with the AP3211. This feature greatly simplifies the design of switch-mode power supplies.

The AP3211 is available in SOT-23-6 package.

Features

- Input Voltage Range: 4.5V to 18V
- Output Voltage Adjustable from 0.81V to 15V
- Fixed 1.4MHz Frequency
- High Efficiency: up to 92%
- Output Current: 1.5A
- Current Mode Control
- Built-in Over Current Protection
- Built-in Thermal Shutdown Function
- Built-in UVLO Function
- Built-in Over Voltage Protection
- Built-in Soft-start

Applications

- LCD TV
- DPF
- Portable DVD

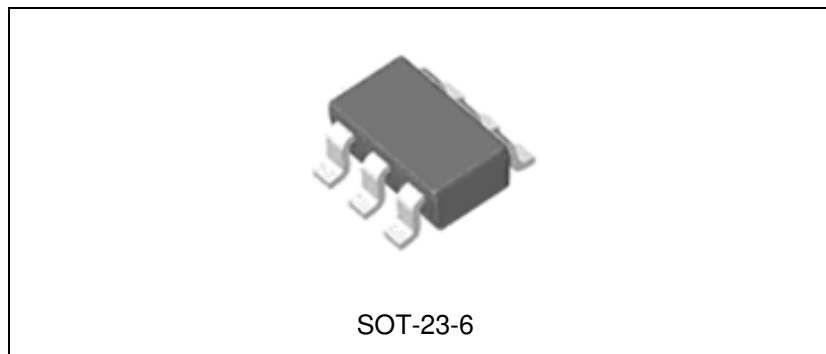

Figure 1. Package Type of AP3211

1.4MHz, 1.5A ASYNCHRONOUS DC-DC BUCK CONVERTER AP3211

Pin Configuration

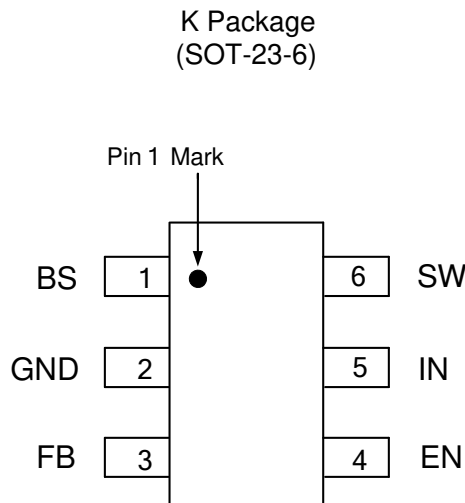

Figure 2. Pin Configuration of AP3211 (Top View)

Pin Description

Pin Number	Pin Name	Function
1	BS	Bootstrap pin. A bootstrap capacitor is connected between the BS pin and SW pin. The voltage across the bootstrap capacitor drives the internal high-side NMOS switch
2	GND	Ground pin
3	FB	Feedback pin. This pin is connected to an external resistor divider to program the system output voltage. When V_{FB} exceeds 20% of the nominal regulation value of 0.81V, the OVP is triggered. When $V_{FB} < 0.25V$, the oscillator frequency is lowered to realize short circuit protection
4	EN	Control input pin. Forcing this pin above 1.5V enables the IC. Forcing this pin below 0.4V shuts down the IC. When the IC is in shutdown mode, all functions are disabled to decrease the supply current below 1 μ A
5	IN	Supply input pin. A capacitor should be connected between the IN pin and GND to keep the DC input voltage constant
6	SW	Power switch output pin. This pin is connected to the inductor and bootstrap capacitor

1.4MHz, 1.5A ASYNCHRONOUS DC-DC BUCK CONVERTER AP3211

Functional Block Diagram

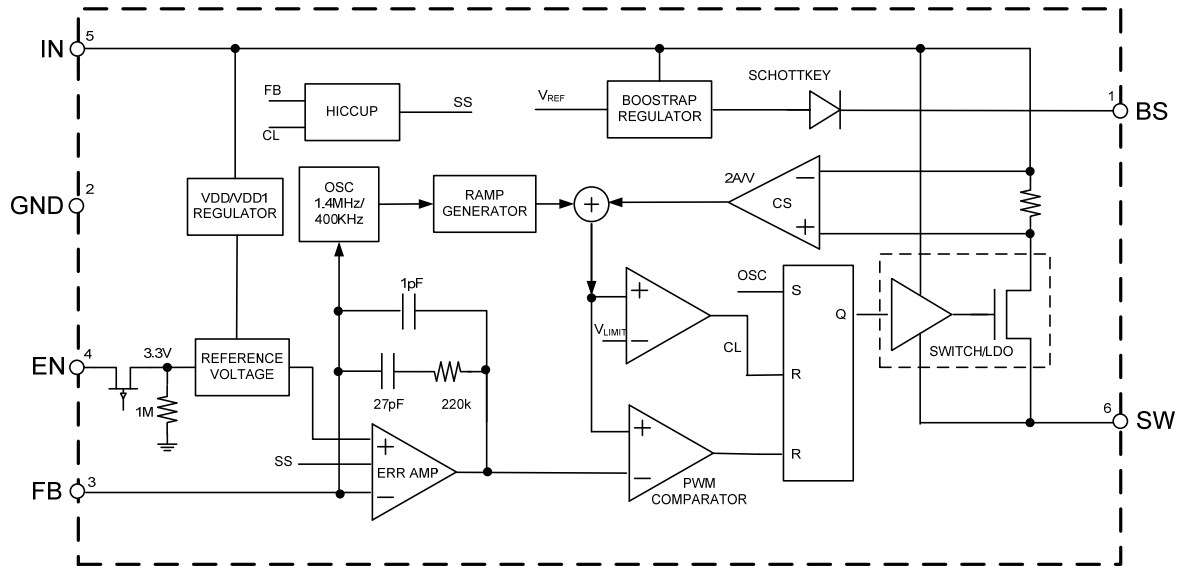
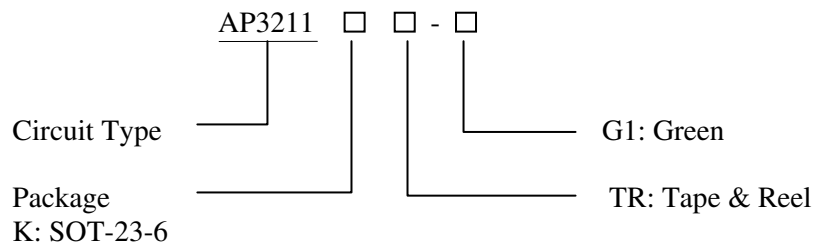

Figure 3. Functional Block Diagram of AP3211

Ordering Information



Package	Temperature Range	Part Number	Marking ID	Packing Type
SOT-23-6	-40 to 85°C	AP3211KTR-G1	GCI	Tape & Reel

BCD Semiconductor's Pb-free products, as designated with "G1" suffix in the part number, are RoHS compliant and green.

**1.4MHz, 1.5A ASYNCHRONOUS DC-DC BUCK CONVERTER AP3211****Absolute Maximum Ratings (Note 1)**

Parameter	Symbol	Value	Unit
Input Pin Voltage	V_{IN}	-0.3 to 20	V
EN Pin Voltage	V_{EN}	-0.3 to $V_{IN}+0.3$	V
SW Pin Voltage	V_{SW}	21	V
Bootstrap Pin Voltage	V_{BS}	-0.3 to $V_{SW}+6$	V
Feedback Pin Voltage	V_{FB}	-0.3 to 6V	V
Thermal Resistance	θ_{JA}	220	°C/W
Operating Junction Temperature	T_J	150	°C
Storage Temperature	T_{STG}	-65 to 150	°C
Lead Temperature (Soldering, 10sec)	T_{LEAD}	260	°C
ESD (Human Body Model)		2000	V
ESD (Machine Model)		200	V

Note 1: Stresses greater than those listed under “Absolute Maximum Ratings” may cause permanent damage to the device. These are stress ratings only, and functional operation of the device at these or any other conditions beyond those indicated under “Recommended Operating Conditions” is not implied. Exposure to “Absolute Maximum Ratings” for extended periods may affect device reliability.

Recommended Operating Conditions

Parameter	Symbol	Min	Max	Unit
Input Voltage	V_{IN}	4.5	18	V
Maximum Output Current	$I_{OUT(MAX)}$	1.5		A
Operating Ambient Temperature	T_A	-40	85	°C

**1.4MHz, 1.5A ASYNCHRONOUS DC-DC BUCK CONVERTER AP3211****Electrical Characteristics**

$V_{IN}=V_{EN}=12V$, $V_{OUT}=3.3V$, $T_A=25^\circ C$, unless otherwise specified.

Parameter	Symbol	Conditions	Min	Typ	Max	Unit
Input Voltage	V_{IN}		4.5		18	V
Quiescent Current	I_Q	$V_{FB}=0.9V$		0.8	1.1	mA
Shutdown Supply Current	I_{SHDN}	$V_{EN}=0V$		0.1	1.0	μA
Feedback Voltage	V_{FB}		0.785	0.810	0.835	V
Feedback Over Voltage Threshold	V_{FBOV}			0.972		V
Feedback Bias Current	I_{FB}	$V_{FB}=0.85V$	-0.1		0.1	μA
Switch On-resistance	R_{DSON}	$I_{SW}=1A$		0.35		Ω
Switch Leakage Current	I_{LEAK}	$V_{IN}=18V$, $V_{EN}=0V$		0.1	10	μA
Switch Current Limit	I_{LIM}		1.8	2.4		A
EN Pin Threshold	V_{ENH}		1.5			V
	V_{ENL}				0.4	
Input UVLO Threshold	V_{UVLO}	V_{IN} Rising	3.3	3.8	4.3	V
Input UVLO Hysteresis	V_{HYS}			0.2		V
Oscillator Frequency	f_{OSC1}		1.1	1.4	1.7	MHz
	f_{OSC2}	Short Circuit		460		kHz
Max. Duty Cycle	D_{MAX}	$V_{FB}=0.6V$		90		%
Min. Duty Cycle	D_{MIN}	$V_{FB}=0.9V$			0	%
Minimum On Time	t_{ON}			100		ns
Thermal Shutdown	T_{OTSD}			160		$^\circ C$
Thermal Shutdown Hysteresis	T_{HYS}			20		$^\circ C$
Soft-start Time	t_{SS}			200		μs

Note 2: R_{DSON} , t_{ON} , T_{OTSD} , T_{HYS} and t_{SS} are guaranteed by design.

1.4MHz, 1.5A ASYNCHRONOUS DC-DC BUCK CONVERTER AP3211

Typical Performance Characteristics

$T_A=25^{\circ}\text{C}$, $V_{IN}=12\text{V}$, $V_{EN}=5\text{V}$, $V_{OUT}=3.3\text{V}$, unless otherwise noted.

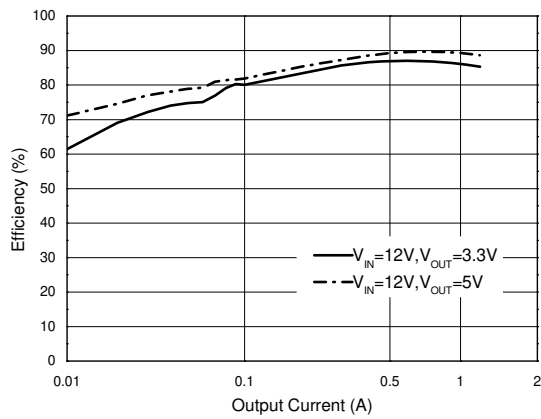

Figure 4. Efficiency vs. Output Current

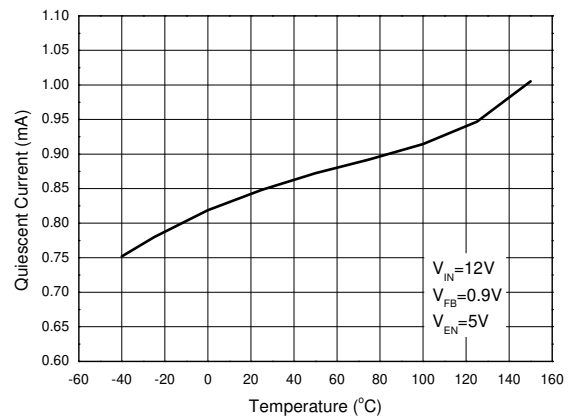

Figure 5. Quiescent Current vs. Temperature

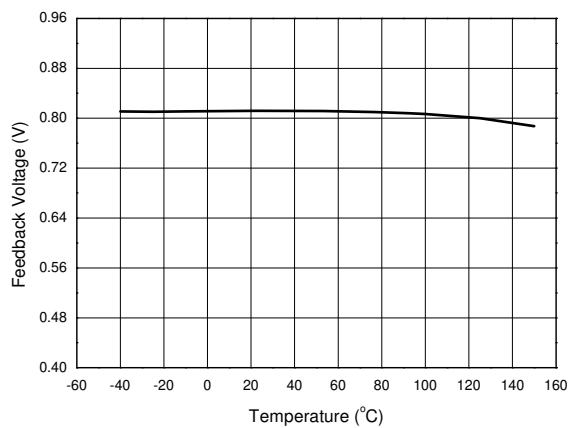

Figure 6. Feedback Voltage vs. Temperature

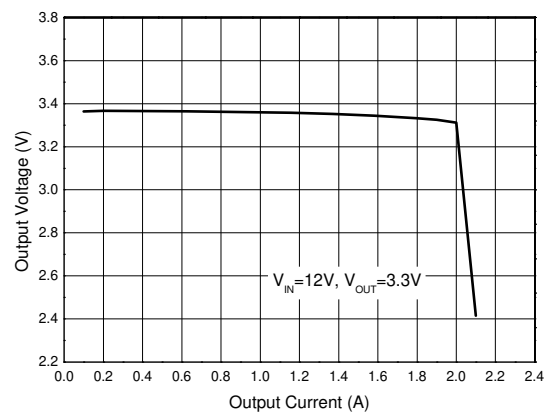

Figure 7. Output Voltage vs. Output Current

1.4MHz, 1.5A ASYNCHRONOUS DC-DC BUCK CONVERTER AP3211

Typical Performance Characteristics (Continued)

$T_A=25^{\circ}\text{C}$, $V_{IN}=12\text{V}$, $V_{EN}=5\text{V}$, $V_{OUT}=3.3\text{V}$, unless otherwise noted.

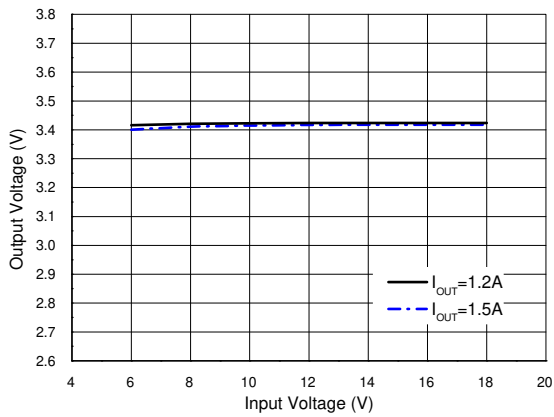

Figure 8. Output Voltage vs. Input Voltage

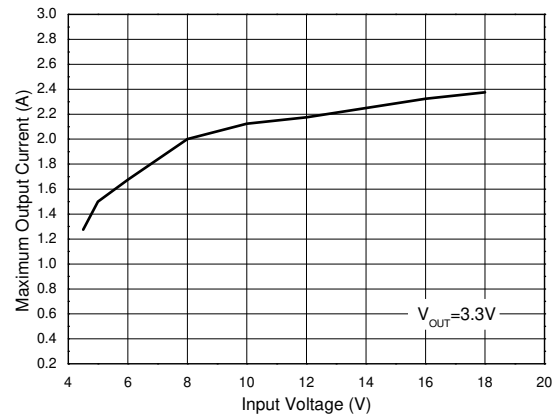

Figure 9. Maximum Output Current vs. Input Voltage

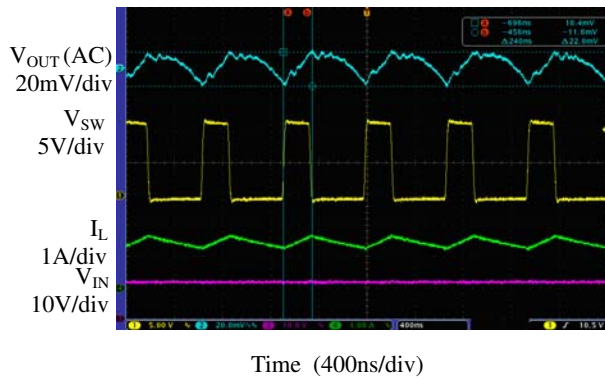

Figure 10. Output Ripple ($I_{OUT}=1.5\text{A}$)

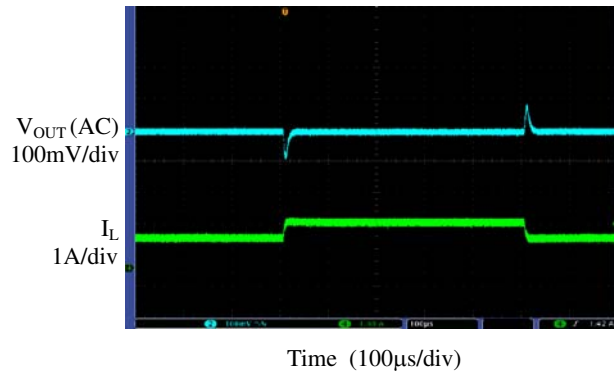

Figure 11. Load Transient ($I_{OUT}=1$ to 1.5A)

1.4MHz, 1.5A ASYNCHRONOUS DC-DC BUCK CONVERTER AP3211

Typical Performance Characteristics (Continued)

$T_A=25^{\circ}\text{C}$, $V_{IN}=12\text{V}$, $V_{EN}=5\text{V}$, $V_{OUT}=3.3\text{V}$, unless otherwise noted.

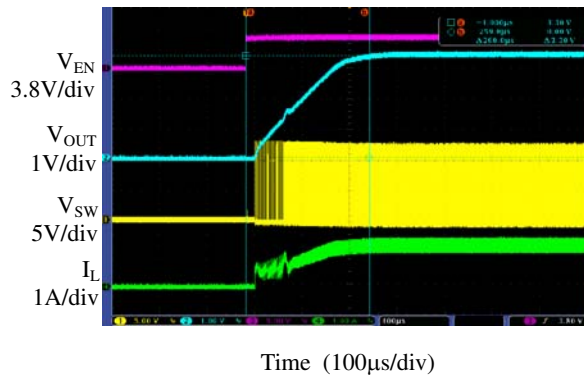

Figure 12. Enable Turn-on Characteristic
(Resistance Load, $R_{LOAD}=2.6\Omega$)

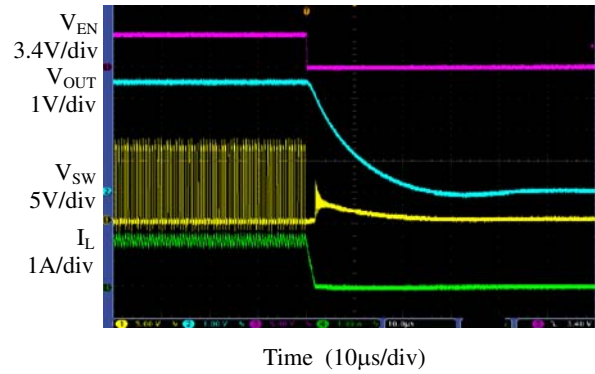

Figure 13. Enable Turn-off Characteristic
(Resistance Load, $R_{LOAD}=2.6\Omega$)

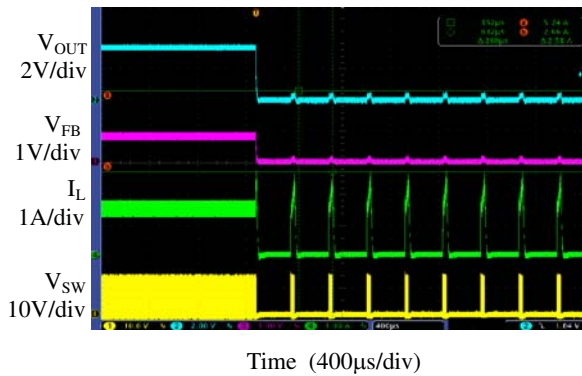

Figure 14. Short Circuit Protection ($I_{OUT}=1.5\text{A}$)

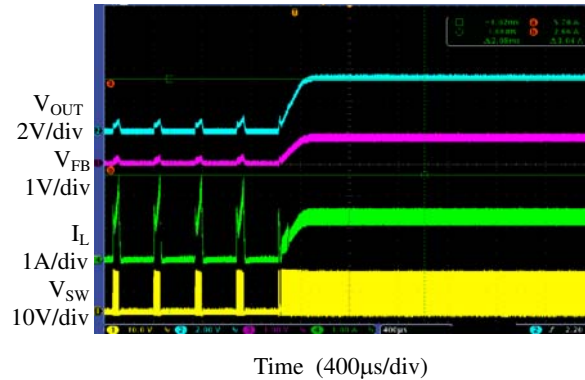

Figure 15. Short Circuit Recovery ($R_{LOAD}=2.6\Omega$)

1.4MHz, 1.5A ASYNCHRONOUS DC-DC BUCK CONVERTER AP3211

Typical Performance Characteristics (Continued)

$T_A=25^{\circ}\text{C}$, $V_{IN}=12\text{V}$, $V_{EN}=5\text{V}$, $V_{OUT}=3.3\text{V}$, unless otherwise noted.

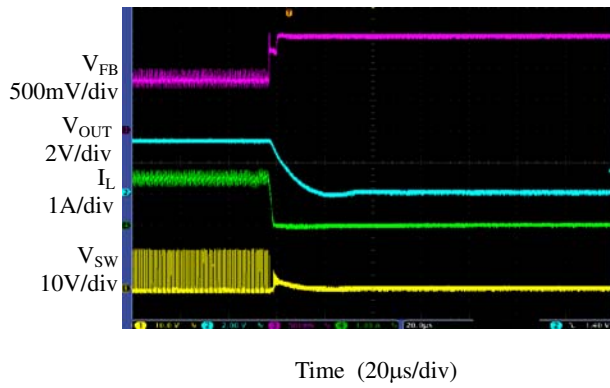

Figure 16. Over Voltage Protection ($I_{OUT}=1.5\text{A}$)

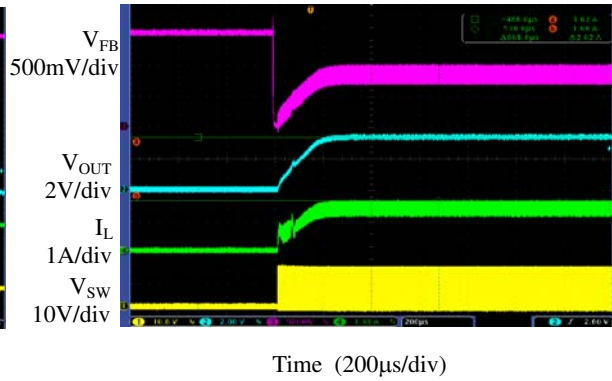

Figure 17. Over Voltage Recovery ($I_{OUT}=1.5\text{A}$)

1.4MHz, 1.5A ASYNCHRONOUS DC-DC BUCK CONVERTER AP3211
Typical Application

Figure 18. Typical Application Circuit of AP3211

1.4MHz, 1.5A ASYNCHRONOUS DC-DC BUCK CONVERTER AP3211

Mechanical Dimensions

SOT-23-6

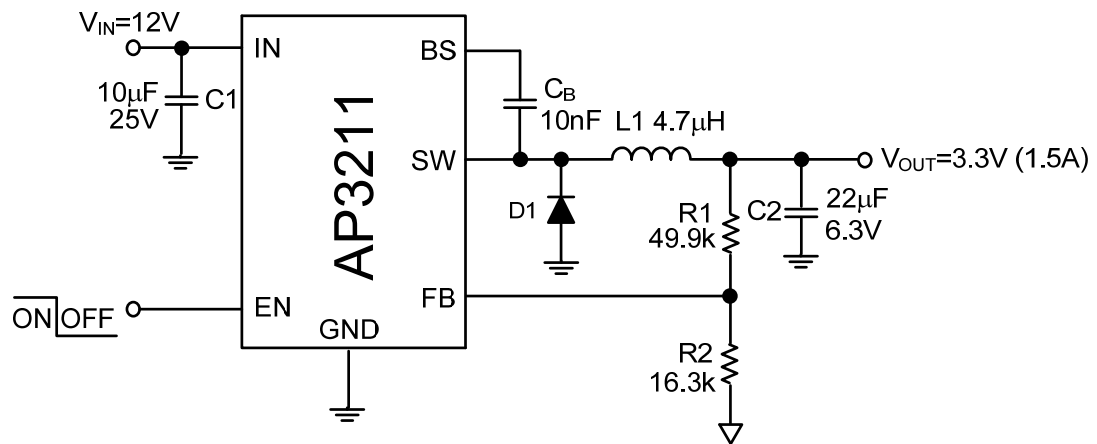
Unit: mm(inch)

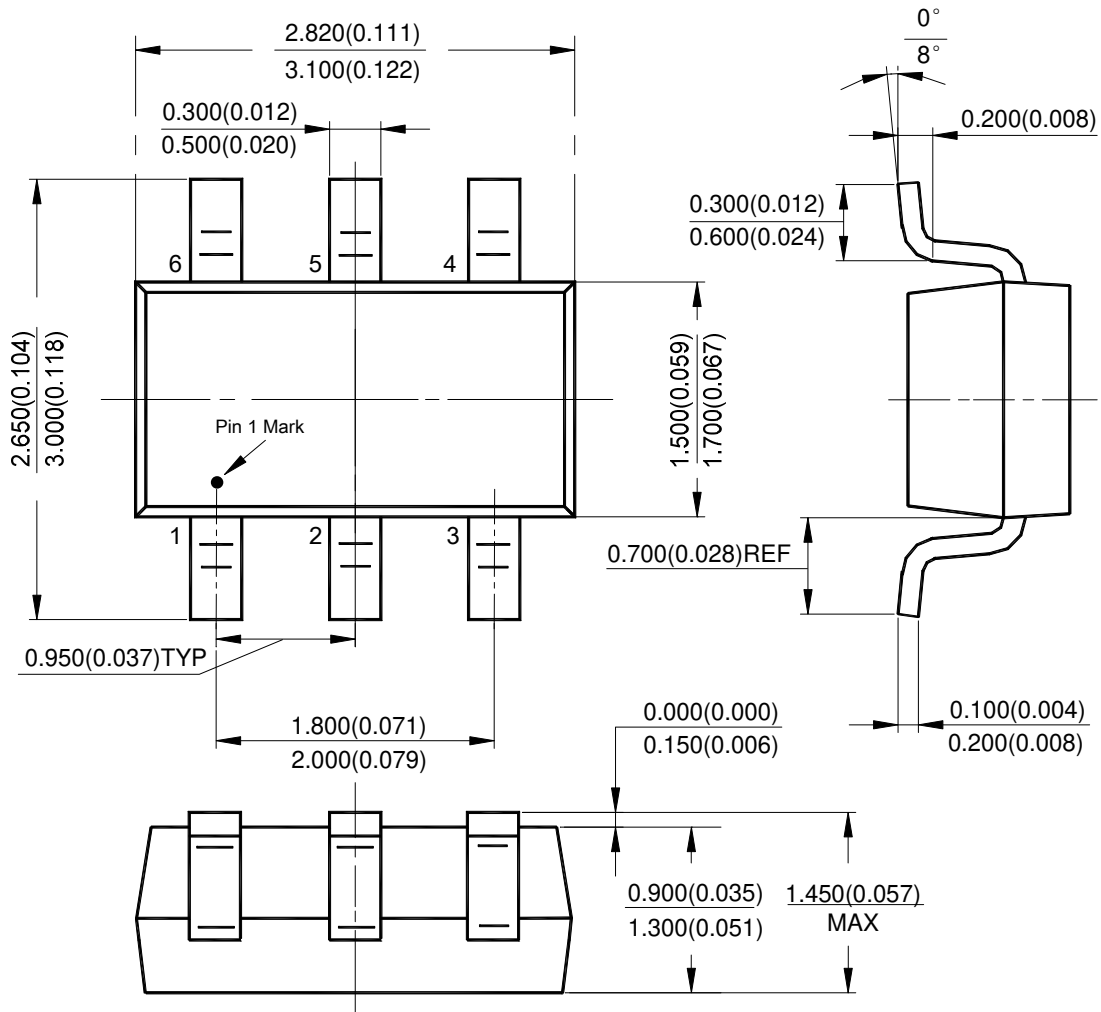

1.4MHz, 1.5A ASYNCHRONOUS DC-DC BUCK CONVERTER AP3211

Mounting Pad Layout

SOT-23-6

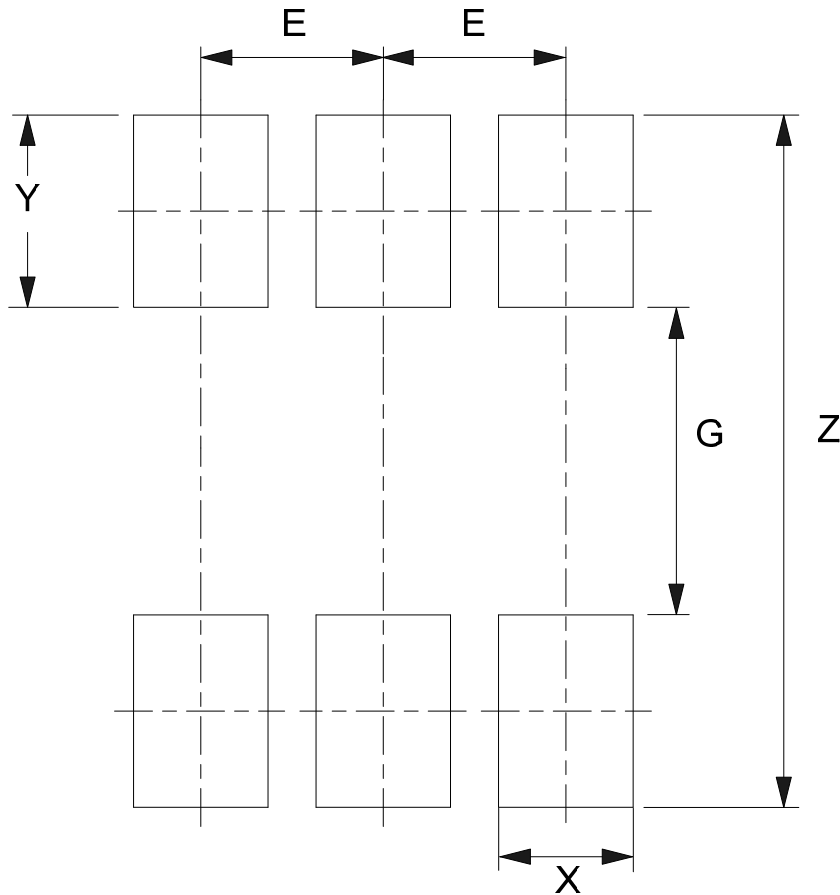

Dimensions	Z (mm)/(inch)	G (mm)/(inch)	X (mm)/(inch)	Y (mm)/(inch)	E (mm)/(inch)
Value	3.600/0.142	1.600/0.063	0.700/0.028	1.000/0.039	0.950/0.037



BCD Semiconductor Manufacturing Limited

<http://www.bcdsemi.com>

IMPORTANT NOTICE

BCD Semiconductor Manufacturing Limited reserves the right to make changes without further notice to any products or specifications herein. BCD Semiconductor Manufacturing Limited does not assume any responsibility for use of any its products for any particular purpose, nor does BCD Semiconductor Manufacturing Limited assume any liability arising out of the application or use of any its products or circuits. BCD Semiconductor Manufacturing Limited does not convey any license under its patent rights or other rights nor the rights of others.

MAIN SITE

- Headquarters

BCD (Shanghai) Micro-electronics Limited

No. 1600, Zi Xing Road, Shanghai ZiZhu Science-based Industrial Park, 200241, P. R. C.
Tel: +86-021-2416-2266, Fax: +86-021-2416-2277

- Wafer Fab

Shanghai SIM-BCD Semiconductor Manufacturing Co., Ltd.

800 Yishan Road, Shanghai 200233, China
Tel: +021-6485-1491, Fax: +86-021-5450-0008

REGIONAL SALES OFFICE

Shenzhen Office

Shanghai SIM-BCD Semiconductor Manufacturing Co., Ltd., Shenzhen Office

Unit A Room 1203, Skyworth Bldg., Gaoxin Ave.1.S., Nanshan District
Shenzhen 518057, China

Tel: +86-0755-8660-4900, Fax: +86-0755-8660-4958

Taiwan Office (Taipei)

BCD Semiconductor (Taiwan) Company Limited

3F, No.17, Lane 171, Sec. 2, Jiu-Zong Rd., Nei-Hu Dist., Taipei(114), Taiwan, R.O.C
Tel: +886-2-2656-2808

Fax: +886-2-2656-2806/26562950

Taiwan Office (Hsinchu)

BCD Semiconductor (Taiwan) Company Limited

8F, No.176, Sec. 2, Gong-Dao 5th Road, East District
HsinChu City 300, Taiwan, R.O.C

Tel: +886-3-5160181, Fax: +886-3-5160181

USA Office

BCD Semiconductor Corp.

48460 Kato Road, Fremont, CA 94538, USA
Tel: +1-510-668-1950

Fax: +1-510-668-1990

Korea Office

BCD Semiconductor Limited Korea office.

Room 101-1112, Digital-Empire II, 486 Sin-dong,
Yeongtong-Gu, Suwon-city, Gyeonggi-do, Korea

Tel: +82-31-695-8430