



Chipsmall Limited consists of a professional team with an average of over 10 year of expertise in the distribution of electronic components. Based in Hongkong, we have already established firm and mutual-benefit business relationships with customers from,Europe,America and south Asia,supplying obsolete and hard-to-find components to meet their specific needs.

With the principle of “Quality Parts,Customers Priority,Honest Operation,and Considerate Service”,our business mainly focus on the distribution of electronic components. Line cards we deal with include Microchip,ALPS,ROHM,Xilinx,Pulse,ON,Everlight and Freescale. Main products comprise IC,Modules,Potentiometer,IC Socket,Relay,Connector.Our parts cover such applications as commercial,industrial, and automotives areas.

We are looking forward to setting up business relationship with you and hope to provide you with the best service and solution. Let us make a better world for our industry!



Contact us

Tel: +86-755-8981 8866 Fax: +86-755-8427 6832

Email & Skype: info@chipsmall.com Web: www.chipsmall.com

Address: A1208, Overseas Decoration Building, #122 Zhenhua RD., Futian, Shenzhen, China



Low Supply Current Output Full Swing CMOS Operational Amplifiers

LMR341G LMR342xxx LMR344xxx

General Description

The LMR341G, LMR342xxx and LMR344xxx are input ground sense, output full swing operational amplifiers. They have the features of low operating supply voltage, low supply current and low input bias current. These are suitable for sensor amplifier, battery-powered electronic equipment, battery monitoring and audio pre-amps for voice. Shutdown function is applied to LMR341G.

Features

- Low Operating Supply Voltage
- Low Input Bias Current
- Low Supply Current
- Low Input Offset Voltage

Applications

- Sensor Amplifier
- Battery Monitoring
- Battery-Powered Electronic Equipment
- Audio Pre-Amps for Voice
- Active Filter
- Buffer
- Consumer Electronics

Key Specifications

- Operating Supply Voltage (Single Supply): +2.7V to +5.5V
- Supply Current (VDD=2.7V, T_A=25°C):
 - LMR341G(Single) 80μA(Typ)
 - LMR342xxx(Dual) 200μA(Typ)
 - LMR344xxx(Quad) 400μA(Typ)
- Voltage Gain (R_L=2kΩ): 103dB(Typ)
- Temperature Range: -40°C to +85°C
- Input Offset Voltage (T_A=25°C): 4mV(Max)
- Input Bias Current (T_A=25°C): 1pA(Typ)
- Turn on time from shutdown: 2μS(Typ)

Package s

	W(Typ) xD(Typ) xH(Max)
SSOP6	2.90mm x 2.80mm x 1.25mm
SOP8	5.00mm x 6.20mm x 1.71mm
SOP-J8	4.90mm x 6.00mm x 1.65mm
SSOP-B8	3.00mm x 6.40mm x 1.35mm
TSSOP-B8	3.00mm x 6.40mm x 1.20mm
MSOP8	2.90mm x 4.00mm x 0.90mm
TSSOP-B8J	3.00mm x 4.90mm x 1.10mm
SOP14	8.70mm x 6.20mm x 1.71mm
SOP-J14	8.65mm x 6.00mm x 1.65mm
TSSOP-B14J	5.00mm x 6.40mm x 1.20mm

Pin Configuration

LMR341G : SSOP6

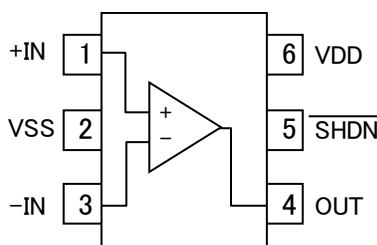

Pin No.	Pin Name
1	+IN
2	VSS
3	-IN
4	OUT
5	SHDN
6	VDD

○Product structure : Silicon monolithic integrated circuit ○This product has no designed protection against radioactive rays.

LMR342F : SOP8
 LMR342FJ : SOP-J8
 LMR342FV : SSOP-B8
 LMR342FVT : TSSOP-B8
 LMR342FVM : MSOP8
 LMR342FVJ : TSSOP-B8J

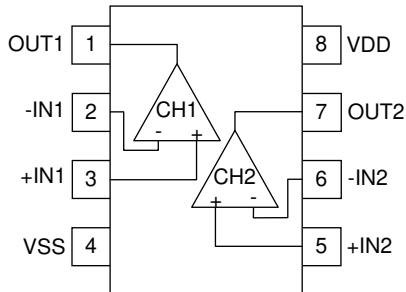

Pin No.	Pin Name
1	OUT1
2	-IN1
3	+IN1
4	VSS
5	+IN2
6	-IN2
7	OUT2
8	VDD

LMR344F : SOP14
 LMR344FJ : SOP-J14
 LMR344FVJ : TSSOP-B14J

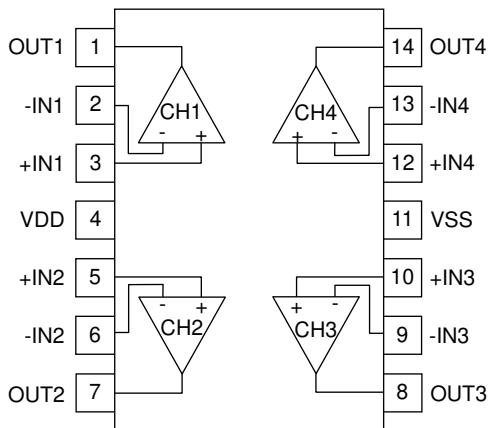

Pin No.	Pin Name
1	OUT1
2	-IN1
3	+IN1
4	VDD
5	+IN2
6	-IN2
7	OUT2
8	OUT3
9	-IN3
10	+IN3
11	VSS
12	+IN4
13	-IN4
14	OUT4

Package				
SSOP6	SOP8	SOP-J8	SSOP-B8	TSSOP-B8
LMR341G	LMR342F	LMR342FJ	LMR342FV	LMR342FVT
Package				
MSOP8	TSSOP-B8J	SOP14	SOP-J14	TSSOP-B14J
LMR342FVM	LMR342FVJ	LMR344F	LMR344FJ	LMR344FVJ

Ordering Information

L	M	R	3	4	x	x	x	x	-	x	x
---	---	---	---	---	---	---	---	---	---	---	---

Part Number LMR341G LMR342xxx LMR344xxx	Package G : SSOP6 F : SOP8 : SOP14 FJ : SOP-J8 : SOP-J14 FV : SSOP-B8 FVT : TSSOP-B8 FVM : MSOP8 FVJ : TSSOP-B8J : TSSOP-B14J	Packaging and forming specification E2: Embossed tape and reel (SOP8/SOP-J8/SSOP-B8/TSSOP-B8/TSSOP-B8J/ SOP14) TR: Embossed tape and reel (SSOP6/MSOP8)
--	---	--

Line-up

Operation Temperature Range	Channels	Package		Orderable Part Number
-40°C to +85°C	1ch	SSOP6	Reel of 3000	LMR341G-TR
	2ch	SOP8	Reel of 2500	LMR342F-E2
		SOP-J8	Reel of 2500	LMR342FJ-E2
		SSOP-B8	Reel of 2500	LMR342FV-E2
		TSSOP-B8	Reel of 3000	LMR342FVT-E2
		MSOP8	Reel of 3000	LMR342FVM-TR
		TSSOP-B8J	Reel of 2500	LMR342FVJ-E2
	4ch	SOP14	Reel of 2500	LMR344F-E2
		SOP-J14	Reel of 2500	LMR344FJ-E2
		TSSOP-B14J	Reel of 2500	LMR344FVJ-E2

Absolute Maximum Ratings ($T_A=25^{\circ}\text{C}$)

Parameter	Symbol		Ratings			Unit
			LMR341G	LMR342xxx	LMR344xxx	
Supply Voltage	VDD - VSS		+7.0			V
Power Dissipation	P _D	SSOP6	0.67 ^(Note 1,9)	-	-	W
		SOP8	-	0.68 ^(Note 2,9)	-	
		SOP-J8	-	0.67 ^(Note 3,9)	-	
		SSOP-B8	-	0.62 ^(Note 4,9)	-	
		TSSOP-B8	-	0.62 ^(Note 4,9)	-	
		TSSOP-B8J	-	0.58 ^(Note 5,9)	-	
		MSOP8	-	0.58 ^(Note 5,9)	-	
		SOP14	-	-	0.56 ^(Note 6,9)	
		SOP-J14	-	-	1.02 ^(Note 7,9)	
TSSOP-B14J	-	-	0.84 ^(Note 8,9)			
Differential Input Voltage ^(Note 8)	V _{ID}		VDD - VSS			V
Input Common-Mode Voltage Range	V _{ICM}		(VSS-0.3) to (VDD+0.3)			V
Input Current ^(Note 9)	I _I		±10			mA
Operating Supply Voltage	V _{opr}		+2.7 to +5.5			V
Operating Temperature	T _{opr}		- 40 to +85			°C
Storage Temperature	T _{stg}		- 55 to +150			°C
Maximum Junction Temperature	T _{Jmax}		+150			°C

(Note 1) To use at temperature above $T_A=25^{\circ}\text{C}$ reduce 5.4mW/°C.

(Note 2) To use at temperature above $T_A=25^{\circ}\text{C}$ reduce 5.5mW/°C.

(Note 3) To use at temperature above $T_A=25^{\circ}\text{C}$ reduce 5.4mW/°C.

(Note 4) To use at temperature above $T_A=25^{\circ}\text{C}$ reduce 5.0mW/°C.

(Note 5) To use at temperature above $T_A=25^{\circ}\text{C}$ reduce 4.7mW/°C.

(Note 6) To use at temperature above $T_A=25^{\circ}\text{C}$ reduce 4.5mW/°C.

(Note 7) To use at temperature above $T_A=25^{\circ}\text{C}$ reduce 8.2mW/°C.

(Note 8) To use at temperature above $T_A=25^{\circ}\text{C}$ reduce 6.8mW/°C.

(Note 9) Mounted on 1-layer glass epoxy PCB 70mm×70mm×1.6mm (Copper foil area less than 3%).

(Note 10) The voltage difference between inverting input and non-inverting input is the differential input voltage.

The input pin voltage is set to more than VSS.

(Note 11) An excessive input current will flow when input voltages of more than VDD+0.6V or less than VSS-0.6V are applied.

The input current can be set to less than the rated current by adding a limiting resistor.

Caution: Operating the IC over the absolute maximum ratings may damage the IC. The damage can either be a short circuit between pins or an open circuit between pins and the internal circuitry. Therefore, it is important to consider circuit protection measures, such as adding a fuse, in case the IC is operated over the absolute maximum ratings.

Electrical Characteristics:

OLMR341G (Unless otherwise specified VDD=+2.7V, VSS=0V, SHDN=VDD)

Parameter	Symbol	Temperature Range	Limits			Unit	Condition
			Min	Typ	Max		
Input Offset Voltage (Note 12,13)	V _{IO}	25°C	-	0.25	4	mV	-
		Full Range	-	-	4.5		
Input Offset Voltage Drift (Note 12,13)	ΔV _{IO} /ΔT	Full Range	-	1.7	-	μV/°C	-
Input Offset Current (Note 12)	I _{IO}	25°C	-	1	-	pA	-
Input Bias Current (Note 12)	I _B	25°C	-	1	200	pA	-
Supply Current (Note 13)	I _{DD}	25°C	-	80	170	μA	R _L =∞, A _V =0dB, +IN=VDD/2
		Full Range	-	-	230		
Shutdown Current	I _{DD_SD}	25°C	-	0.2	1000	nA	SHDN=GND
Maximum Output Voltage(High)	V _{OH}	25°C	VDD-0.06	VDD-0.03	-	V	R _L =2kΩ to VDD/2
			VDD-0.03	VDD-0.01	-		R _L =10kΩ to VDD/2
Maximum Output Voltage(Low)	V _{OL}	25°C	-	0.03	0.06	V	R _L =2kΩ to VDD/2
			-	0.01	0.03		R _L =10kΩ to VDD/2
Large Signal Voltage Gain	A _V	25°C	78	113	-	dB	R _L =10kΩ to VDD/2
			72	103	-		R _L =2kΩ to VDD/2
Input Common-Mode Voltage Range	V _{ICM}	25°C	0	-	1.7	V	-
Common-Mode Rejection Ratio	CMRR	25°C	56	80	-	dB	V _{ICM} =VDD/2
Power Supply Rejection Ratio	PSRR	25°C	65	82	-	dB	VDD=2.7V to 5.0V V _{ICM} =0.5V
Output Source Current (Note 14)	I _{SOURCE}	25°C	20	32	-	mA	OUT=0V, short current
Output Sink Current (Note 14)	I _{SINK}	25°C	30	45	-	mA	OUT=2.7V short current
Slew Rate	SR	25°C	-	1.0	-	V/μs	R _L =10kΩ, +IN=1.2V _{P-P}
Gain Bandwidth	GBW	25°C	-	2.0	-	MHz	C _L =200pF, R _L =100kΩ A _V =40dB, f=100kHz
Unit Gain Frequency	f _T	25°C	-	1.2	-	MHz	C _L =200pF, R _L =100kΩ A _V =40dB, gain=0dB
Phase Margin	θ _M	25°C	-	50	-	deg	C _L =20pF, R _L =100kΩ A _V =40dB
Gain Margin	G _M	25°C	-	4.5	-	dB	C _L =20pF, R _L =100kΩ A _V =40dB
Input Referred Noise Voltage	V _N	25°C	-	40	-	nV/√Hz	f=1kHz, A _V =40dB
			-	3	-	μVrms	A _V =40dB, DIN-AUDIO
Total Harmonic Distortion + Noise	THD+N	25°C	-	0.017	-	%	R _L =600Ω, A _V =0dB OUT=1V _{P-P} , f=1kHz DIN-AUDIO
Turn On Time From Shutdown	TON	25°C	-	2	-	μs	-
Turn On Voltage High	VSHDN_H	25°C	-	1.8	-	V	-
Turn On Voltage Low	VSHDN_L	25°C	-	1.1	-	V	-

(Note 12) Absolute value.

(Note 13) Full Range: T_A=-40°C to +85°C

(Note 14) Under the high temperature environment, consider the power dissipation of IC when selecting the output current.

When the terminal short circuits are continuously output, the output current is reduced to climb to the temperature inside IC.

Electrical Characteristics - continued

OLMR341G (Unless otherwise specified VDD=+5.0V, VSS=0V, SHDN=VDD)

Parameter	Symbol	Temperature Range	Limits			Unit	Condition
			Min	Typ	Max		
Input Offset Voltage (Note 15,16)	V _{IO}	25°C	-	0.25	4	mV	-
		Full Range	-	-	4.5		
Input Offset Voltage Drift (Note 15,16)	ΔV _{IO} /ΔT	Full Range	-	1.9	-	μV/°C	-
Input Offset Current (Note 15)	I _{IO}	25°C	-	1	-	pA	-
Input Bias Current (Note 15)	I _B	25°C	-	1	-	pA	-
Supply Current (Note 16)	I _{DD}	25°C	-	80	200	μA	R _L =∞, A _V =0dB, +IN=VDD/2
		Full Range	-	-	260		
Shutdown Current	I _{DD_SD}	25°C	-	0.5	1000	nA	SHDN=GND
Maximum Output Voltage(High)	V _{OH}	25°C	VDD-0.06	VDD-0.04	-	V	R _L =2kΩ to VDD/2
			VDD-0.03	VDD-0.01	-		R _L =10kΩ to VDD/2
Maximum Output Voltage(Low)	V _{OL}	25°C	-	0.04	0.06	V	R _L =2kΩ to VDD/2
			-	0.01	0.03		R _L =10kΩ to VDD/2
Large Signal Voltage Gain	A _V	25°C	78	116	-	dB	R _L =10kΩ to VDD/2
			72	107	-		R _L =2kΩ to VDD/2
Input Common-Mode Voltage Range	V _{ICM}	25°C	0	-	4	V	-
Common-Mode Rejection Ratio	CMRR	25°C	56	86	-	dB	V _{ICM} = VDD/2
Power Supply Rejection Ratio	PSRR	25°C	65	82	-	dB	VDD=2.7V to 5.0V V _{ICM} =0.5V
Output Source Current (Note 17)	I _{SOURCE}	25°C	85	113	-	mA	OUT=0V, short current
Output Sink Current (Note 17)	I _{SINK}	25°C	80	115	-	mA	OUT=5V, short current
Slew Rate	SR	25°C	-	1.0	-	V/μs	R _L =10kΩ, +IN=2V _{P-P}
Gain Bandwidth	GBW	25°C	-	2.0	-	MHz	C _L =200pF, R _L =10kΩ A _V =40dB, f=100kHz
Unit Gain Frequency	f _T	25°C	-	1.2	-	MHz	C _L =200pF, R _L =10kΩ A _V =40dB, gain=0dB
Phase Margin	θ _M	25°C	-	50	-	deg	C _L =20pF, R _L =100kΩ A _V =40dB
Gain Margin	G _M	25°C	-	4.5	-	dB	C _L =20pF, R _L =100kΩ A _V =40dB
Input Referred Noise Voltage	V _N	25°C	-	40	-	nV/√Hz	f=1kHz, A _V =40dB
			-	3	-	μVrms	A _V =40dB, DIN-AUDIO
Total Harmonic Distortion + Noise	THD+N	25°C	-	0.012	-	%	R _L =600Ω, A _V =0dB OUT=1V _{P-P} , f=1kHz DIN-AUDIO
Turn On Time From Shutdown	TON	25°C	-	2	-	μs	-
Turn On Voltage High	VSHDN_H	25°C	-	3.0	-	V	-
Turn On Voltage Low	VSHDN_L	25°C	-	2.0	-	V	-

(Note 15) Absolute value

(Note 16) Full Range: T_A=-40°C to +85°C

(Note 17) Under the high temperature environment, consider the power dissipation of IC when selecting the output current.

When the terminal short circuits are continuously output, the output current is reduced to climb to the temperature inside IC.

Electrical Characteristics - continued

OLMR342xxx (Unless otherwise specified VDD=+2.7V, VSS=0V, TA=25°C)

Parameter	Symbol	Temperature Range	Limit			Unit	Condition
			Min	Typ	Max		
Input Offset Voltage (Note 18,19)	V _{IO}	25°C	-	0.25	4	mV	-
		Full Range	-	-	4.5		
Input Offset Voltage Drift (Note 18,19)	ΔV _{IO} /ΔT	Full Range	-	1.7	-	μV/°C	-
Input Offset Current (Note 18)	I _{IO}	25°C	-	1	-	pA	-
Input Bias Current (Note 18)	I _B	25°C	-	1	200	pA	-
Supply Current (Note 19)	I _{DD}	25°C	-	200	340	μA	R _L =∞, All Op-Amps A _V =0dB, +IN=VDD/2
		Full Range	-	-	460		
Maximum Output Voltage (High)	V _{OH}	25°C	VDD-0.06	VDD-0.03	-	V	R _L =2kΩ, V _{RL} =VDD/2 R _L =10kΩ, V _{RL} =VDD/2
			VDD-0.03	VDD-0.01	-		
Maximum Output Voltage (Low)	V _{OL}	25°C	-	0.03	0.06	V	R _L =2kΩ, V _{RL} =VDD/2 R _L =10kΩ, V _{RL} =VDD/2
			-	0.01	0.03		
Large Single Voltage Gain	A _V	25°C	78	113	-	dB	R _L =10kΩ, V _{RL} =VDD/2 R _L =2kΩ, V _{RL} =VDD/2
			72	103	-		
Input Common-Mode Voltage Range	V _{ICM}	25°C	0	-	1.7	V	-
Common-Mode Rejection Ratio	CMRR	25°C	56	80	-	dB	V _{ICM} =VDD/2
Power Supply Rejection Ratio	PSRR	25°C	65	82	-	dB	VDD=2.7V to 5.0V V _{ICM} =VDD/2
Output Source Current (Note 20)	I _{SOURCE}	25°C	20	32	-	mA	OUT=0V Short Circuit Current
Output Sink Current (Note 20)	I _{SINK}	25°C	15	24	-	mA	OUT=2.7V Short Circuit Current
Slew Rate	SR	25°C	-	1.0	-	V/μs	R _L =10kΩ, +IN=1.2V _{P-P}
Gain Bandwidth	GBW	25°C	-	2	-	MHz	C _L =200pF, R _L =100kΩ A _V =40dB, f=100kHz
Unity Gain Frequency	f _T	25°C	-	1.2	-	MHz	C _L =200pF, R _L =100kΩ A _V =40dB
Phase Margin	θ _M	25°C	-	50	-	deg	C _L =20pF, R _L =100kΩ A _V =40dB
Gain Margin	G _M	25°C	-	4.5	-	dB	C _L =20pF, R _L =100kΩ A _V =40dB
Input Referred Noise Voltage	V _N	25°C	-	40	-	nV/√Hz	f=1kHz, A _V =40dB
			-	3	-	μVrms	A _V =40dB, DIN-AUDIO
Total Harmonic Distortion + Noise	THD+N	25°C	-	0.017	-	%	R _L =600Ω, A _V =0dB OUT=1V _{P-P} , f=1kHz DIN-AUDIO
Channel Separation	CS	25°C	-	100	-	dB	A _V =40dB, f=1kHz OUT=0.8Vrms

(Note 18) Absolute value.

(Note 19) Full Range: T_A=-40°C to +85°C

(Note 20) Consider the power dissipation of the IC under high temperature environment when selecting the output current value.

There may be a case where the output current value is reduced due to the rise in IC temperature caused by the heat generated inside the IC.

Electrical Characteristics - continued

OLMR342xxx (Unless otherwise specified VDD=+5.0V, VSS=0V, TA=25°C)

Parameter	Symbol	Temperature Range	Limit			Unit	Condition
			Min	Typ	Max		
Input Offset Voltage (Note 21,22)	V _{IO}	25°C	-	0.25	4	mV	-
		Full Range	-	-	4.5		
Input Offset Voltage Drift (Note 21,22)	ΔV _{IO} /ΔT	Full Range	-	1.9	-	μV/°C	-
Input Offset Current (Note 21)	I _{IO}	25°C	-	1	-	pA	-
Input Bias Current (Note 21)	I _B	25°C	-	1	200	pA	-
Supply Current (Note 22)	I _{DD}	25°C	-	214	400	μA	R _L =∞, All Op-Amps A _V =0dB, +IN=VDD/2
		Full Range	-	-	520		
Maximum Output Voltage (High)	V _{OH}	25°C	VDD-0.06	VDD-0.04	-	V	R _L =2kΩ, V _{RL} =VDD/2 R _L =10kΩ, V _{RL} =VDD/2
			VDD-0.03	VDD-0.01	-		
Maximum Output Voltage (Low)	V _{OL}	25°C	-	0.04	0.06	V	R _L =2kΩ, V _{RL} =VDD/2 R _L =10kΩ, V _{RL} =VDD/2
			-	0.01	0.03		
Large Single Voltage Gain	A _V	25°C	78	116	-	dB	R _L =10kΩ, V _{RL} =VDD/2 R _L =2kΩ, V _{RL} =VDD/2
			72	107	-		
Input Common-Mode Voltage Range	V _{ICM}	25°C	0	-	4.0	V	-
Common-Mode Rejection Ratio	CMRR	25°C	56	86	-	dB	V _{ICM} =VDD/2
Power Supply Rejection Ratio	PSRR	25°C	65	85	-	dB	VDD=2.7V to 5.0V V _{ICM} =VDD/2
Output Source Current (Note 23)	I _{SOURCE}	25°C	85	113	-	mA	OUT=0V Short Circuit Current
Output Sink Current (Note 23)	I _{SINK}	25°C	50	75	-	mA	OUT=5.0V Short Circuit Current
Slew Rate	SR	25°C	-	1.0	-	V/μs	R _L =10kΩ, +IN=2.0V _{P-P}
Gain Bandwidth	GBW	25°C	-	2	-	MHz	C _L =200pF, R _L =100kΩ A _V =40dB, f=100kHz
Unity Gain Frequency	f _T	25°C	-	1.2	-	MHz	C _L =200pF, R _L =100kΩ A _V =40dB
Phase Margin	θ _M	25°C	-	50	-	deg	C _L =20pF, R _L =100kΩ A _V =40dB
Gain Margin	G _M	25°C	-	4.5	-	dB	C _L =20pF, R _L =100kΩ A _V =40dB
Input Referred Noise Voltage	V _N	25°C	-	39	-	nV/√Hz	f=1kHz, A _V =40dB
			-	3	-	μVrms	A _V =40dB, DIN-AUDIO
Total Harmonic Distortion + Noise	THD+N	25°C	-	0.012	-	%	R _L =600Ω, A _V =0dB OUT=1V _{P-P} , f=1kHz DIN-AUDIO
Channel Separation	CS	25°C	-	100	-	dB	A _V =40dB, f=1kHz OUT=0.8Vrms

(Note 21) Absolute value.

(Note 22) Full Range: T_A=-40°C to +85°C

(Note 23) Consider the power dissipation of the IC under high temperature environment when selecting the output current value.

There may be a case where the output current value is reduced due to the rise in IC temperature caused by the heat generated inside the IC.

Electrical Characteristics - continued

OLMR344xxx (Unless otherwise specified VDD=+2.7V, VSS=0V, TA=25°C)

Parameter	Symbol	Temperature Range	Limit			Unit	Condition
			Min	Typ	Max		
Input Offset Voltage (Note 24,25)	V _{IO}	25°C	-	0.25	4	mV	-
		Full Range	-	-	4.5		
Input Offset Voltage Drift (Note 24,25)	ΔV _{IO} /ΔT	Full Range	-	1.7	-	μV/°C	-
Input Offset Current (Note 24)	I _{IO}	25°C	-	1	-	pA	-
Input Bias Current (Note 24)	I _B	25°C	-	1	200	pA	-
Supply Current (Note 25)	I _{DD}	25°C	-	400	680	μA	R _L =∞, All Op-Amps A _v =0dB, +IN=VDD/2
		Full Range	-	-	920		
Maximum Output Voltage (High)	V _{OH}	25°C	VDD-0.06	VDD-0.03	-	V	R _L =2kΩ, V _{RL} =VDD/2 R _L =10kΩ, V _{RL} =VDD/2
			VDD-0.03	VDD-0.01	-		
Maximum Output Voltage (Low)	V _{OL}	25°C	-	0.03	0.06	V	R _L =2kΩ, V _{RL} =VDD/2 R _L =10kΩ, V _{RL} =VDD/2
			-	0.01	0.03		
Large Single Voltage Gain	A _v	25°C	78	113	-	dB	R _L =10kΩ, V _{RL} =VDD/2 R _L =2kΩ, V _{RL} =VDD/2
			72	103	-		
Input Common-Mode Voltage Range	V _{ICM}	25°C	0	-	1.7	V	-
Common-Mode Rejection Ratio	CMRR	25°C	56	80	-	dB	V _{ICM} =VDD/2
Power Supply Rejection Ratio	PSRR	25°C	65	82	-	dB	VDD=2.7V to 5.0V V _{ICM} =VDD/2
Output Source Current (Note 26)	I _{SOURCE}	25°C	20	32	-	mA	OUT=0V Short Circuit Current
Output Sink Current (Note 26)	I _{SINK}	25°C	15	24	-	mA	OUT=2.7V Short Circuit Current
Slew Rate	SR	25°C	-	1.0	-	V/μs	R _L =10kΩ, +IN=1.2 V _{P-P}
Gain Bandwidth	GBW	25°C	-	2	-	MHz	C _L =200pF, R _L =100kΩ A _v =40dB, f=100kHz
Unity Gain Frequency	f _T	25°C	-	1.2	-	MHz	C _L =200pF, R _L =100kΩ A _v =40dB
Phase Margin	θ _M	25°C	-	50	-	deg	C _L =20pF, R _L =100kΩ A _v =40dB
Gain Margin	G _M	25°C	-	4.5	-	dB	C _L =20pF, R _L =100kΩ A _v =40dB
Input Referred Noise Voltage	V _N	25°C	-	40	-	nV/√Hz	f=1kHz, A _v =40dB
			-	3	-	μVrms	A _v =40dB, DIN-AUDIO
Total Harmonic Distortion + Noise	THD+N	25°C	-	0.017	-	%	R _L =600Ω, A _v =0dB OUT=1V _{P-P} , f=1kHz DIN-AUDIO
Channel Separation	CS	25°C	-	100	-	dB	A _v =40dB, f=1kHz OUT=0.8Vrms

(Note 24) Absolute value.

(Note 25) Full Range: T_A=-40°C to +85°C

(Note 26) Consider the power dissipation of the IC under high temperature environment when selecting the output current value.

There may be a case where the output current value is reduced due to the rise in IC temperature caused by the heat generated inside the IC.

Electrical Characteristics - continued

OLMR344xxx (Unless otherwise specified VDD=+5.0V, VSS=0V, T_A=25°C)

Parameter	Symbol	Temperature Range	Limit			Unit	Condition
			Min	Typ	Max		
Input Offset Voltage (Note 27,28)	V _{IO}	25°C	-	0.25	4	mV	-
		Full Range	-	-	4.5		
Input Offset Voltage Drift (Note 27,28)	ΔV _{IO} /ΔT	Full Range	-	1.9	-	μV/°C	-
Input Offset Current (Note 27)	I _{IO}	25°C	-	1	-	pA	-
Input Bias Current (Note 27)	I _B	25°C	-	1	200	pA	-
Supply Current (Note 28)	I _{DD}	25°C	-	428	800	μA	R _L =∞, All Op-Amps A _V =0dB, +IN=VDD/2
		Full Range	-	-	1040		
Maximum Output Voltage (High)	V _{OH}	25°C	VDD-0.06	VDD-0.04	-	V	R _L =2kΩ, V _{RL} =VDD/2 R _L =10kΩ, V _{RL} =VDD/2
			VDD-0.03	VDD-0.01	-		
Maximum Output Voltage (Low)	V _{OL}	25°C	-	0.04	0.06	V	R _L =2kΩ, V _{RL} =VDD/2 R _L =10kΩ, V _{RL} =VDD/2
			-	0.01	0.03		
Large Single Voltage Gain	A _V	25°C	78	116	-	dB	R _L =10kΩ, V _{RL} =VDD/2 R _L =2kΩ, V _{RL} =VDD/2
			72	107	-		
Input Common-Mode Voltage Range	V _{ICM}	25°C	0	-	4.0	V	-
Common-Mode Rejection Ratio	CMRR	25°C	56	86	-	dB	V _{ICM} =VDD/2
Power Supply Rejection Ratio	PSRR	25°C	65	85	-	dB	VDD=2.7V to 5.0V V _{ICM} =VDD/2
Output Source Current (Note 29)	I _{SOURCE}	25°C	85	113	-	mA	OUT=0V Short Circuit Current
Output Sink Current (Note 29)	I _{SINK}	25°C	50	75	-	mA	OUT=5V Short Circuit Current
Slew Rate	SR	25°C	-	1.0	-	V/μs	R _L =10kΩ, +IN=2.0V _{P-P}
Gain Bandwidth	GBW	25°C	-	2	-	MHz	C _L =200pF, R _L =100kΩ A _V =40dB, f=100kHz
Unity Gain Frequency	f _T	25°C	-	1.2	-	MHz	C _L =200pF, R _L =100kΩ A _V =40dB
Phase Margin	θ _M	25°C	-	50	-	deg	C _L =20pF, R _L =100kΩ A _V =40dB
Gain Margin	G _M	25°C	-	4.5	-	dB	C _L =20pF, R _L =100kΩ A _V =40dB
Input Referred Noise Voltage	V _N	25°C	-	39	-	nV/√Hz	f=1kHz, A _V =40dB
			-	3	-	μVrms	A _V =40dB, DIN-AUDIO
Total Harmonic Distortion + Noise	THD+N	25°C	-	0.012	-	%	R _L =600Ω, A _V =0dB OUT=1V _{P-P} , f=1kHz DIN-AUDIO
Channel Separation	CS	25°C	-	100	-	dB	A _V =40dB, f=1kHz OUT=0.8Vrms

(Note 27) Absolute value.

(Note 28) Full Range: T_A=-40°C to +85°C

(Note 29) Consider the power dissipation of the IC under high temperature environment when selecting the output current value.

There may be a case where the output current value is reduced due to the rise in IC temperature caused by the heat generated inside the IC.

Description of Electrical Characteristics

Described below are descriptions of the relevant electrical terms used in this datasheet. Items and symbols used are also shown. Note that item name and symbol and their meaning may differ from those on another manufacturer's document or general document.

1. Absolute maximum ratings

Absolute maximum rating items indicate the condition which must not be exceeded. Application of voltage in excess of absolute maximum rating or use out of absolute maximum rated temperature environment may cause deterioration of characteristics.

- (1) Supply Voltage (VDD/VSS)
Indicates the maximum voltage that can be applied between the VDD terminal and VSS terminal without deterioration or destruction of characteristics of internal circuit.
- (2) Differential Input Voltage (V_{ID})
Indicates the maximum voltage that can be applied between non-inverting and inverting terminals without damaging the IC.
- (3) Input Common-Mode Voltage Range (V_{ICM})
Indicates the maximum voltage that can be applied to the non-inverting and inverting terminals without deterioration or destruction of electrical characteristics. Input common-mode voltage range of the maximum ratings does not assure normal operation of IC. For normal operation, use the IC within the input common-mode voltage range characteristics.
- (4) Power Dissipation (P_D)
Indicates the power that can be consumed by the IC when mounted on a specific board at the ambient temperature 25°C (normal temperature). As for package product, P_D is determined by the temperature that can be permitted by the IC in the package (maximum junction temperature) and the thermal resistance of the package.

2. Electrical characteristics

- (1) Input Offset Voltage (V_{IO})
Indicates the voltage difference between non-inverting terminal and inverting terminals. It can be translated into the input voltage difference required for setting the output voltage at 0 V.
- (2) Input Offset Voltage drift ($\Delta V_{IO}/\Delta T$)
Denotes the ratio of the input offset voltage fluctuation to the ambient temperature fluctuation.
- (3) Input Offset Current (I_{IO})
Indicates the difference of input bias current between the non-inverting and inverting terminals.
- (4) Input Bias Current (I_B)
Indicates the current that flows into or out of the input terminal. It is defined by the average of input bias currents at the non-inverting and inverting terminals.
- (5) Supply Current (I_{DD})
Indicates the current that flows within the IC under specified no-load conditions.
- (6) Shutdown current (I_{DD_SD})
Indicates the current when the circuit is shutdown.
- (7) Maximum Output Voltage(High) / Maximum Output Voltage(Low) (V_{OH}/V_{OL})
Indicates the voltage range of the output under specified load condition. It is typically divided into maximum output voltage high and low. Maximum output voltage high indicates the upper limit of output voltage. Maximum output voltage low indicates the lower limit.
- (8) Large Signal Voltage Gain (A_V)
Indicates the amplifying rate (gain) of output voltage against the voltage difference between non-inverting terminal and inverting terminal. It is normally the amplifying rate (gain) with reference to DC voltage.
 $A_V = (\text{Output voltage}) / (\text{Differential Input voltage})$
- (9) Input Common-Mode Voltage Range (V_{ICM})
Indicates the input voltage range where IC normally operates.
- (10) Common-Mode Rejection Ratio (CMRR)
Indicates the ratio of fluctuation of input offset voltage when the input common mode voltage is changed. It is normally the fluctuation of DC.
 $CMRR = (\text{Change of Input common-mode voltage}) / (\text{Input offset fluctuation})$
- (11) Power Supply Rejection Ratio (PSRR)
Indicates the ratio of fluctuation of input offset voltage when supply voltage is changed.
It is normally the fluctuation of DC.
 $PSRR = (\text{Change of power supply voltage}) / (\text{Input offset fluctuation})$
- (12) Output Source Current/ Output Sink Current (I_{SOURCE} / I_{SINK})
The maximum current that can be output from the IC under specific output conditions. The output source current indicates the current flowing out from the IC, and the output sink current indicates the current flowing into the IC.
- (13) Slew Rate (SR)
Indicates the ratio of the change in output voltage with time when a step input signal is applied.
- (14) Unity Gain Frequency (f_T)
Indicates a frequency where the voltage gain of operational amplifier is 1.

- (15) Gain Bandwidth (GBW)
The product of the open-loop voltage gain and the frequency at which the voltage gain decreases 6dB/octave.
- (16) Phase Margin (θ) (θ_M)
Indicates the margin of phase from 180 degree phase lag at unity gain frequency.
- (17) Gain Margin (GM)
Indicates the difference between 0dB and the gain where operational amplifier has 180 degree phase delay.
- (18) Input Referred Noise Voltage (V_N)
Indicates a noise voltage generated inside the operational amplifier equivalent by ideal voltage source connected in series with input terminal.
- (19) Total Harmonic Distortion + Noise (THD+N)
Indicates the fluctuation of input offset voltage or that of output voltage with reference to the change of output voltage of driven channel.
- (20) Channel Separation (CS)
Indicates the fluctuation in the output voltage of the driven channel with reference to the change of output voltage of the channel which is not driven.
- (21) Turn On Time From Shutdown (T_{on})
Indicates the time from applying the voltage to shutdown terminal until the IC is active.
- (22) Turn On Voltage / Turn Off Voltage (VSHDN_H/ VSHDN_L)
The IC is active if the shutdown terminal is applied more than Turn On Voltage (VSHDN_H).
The IC is shutdown if the shutdown terminal is applied less than Turn Off Voltage (VSHDN_L).

Typical Performance Curves

OLMR341G

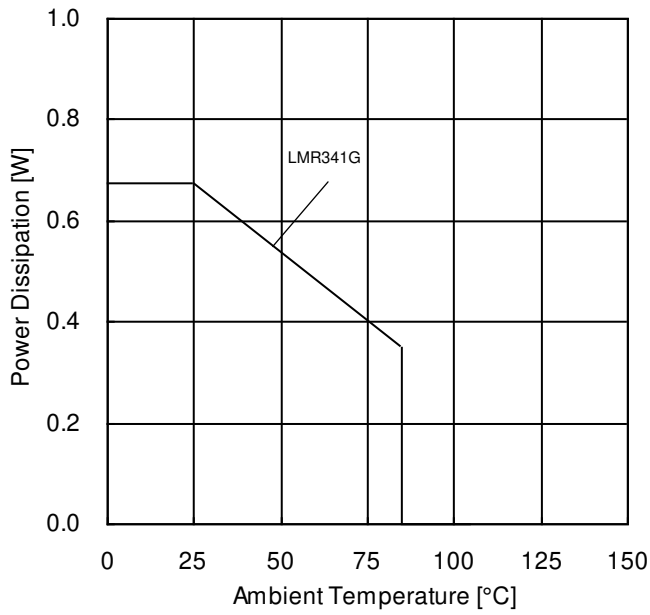

Figure 1. Power Dissipation vs Ambient Temperature (Derating Curve)

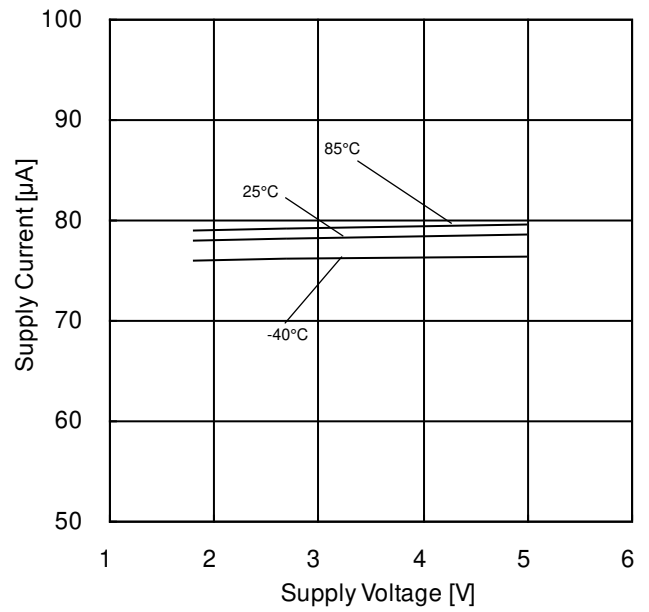

Figure 2. Supply Current vs Supply Voltage

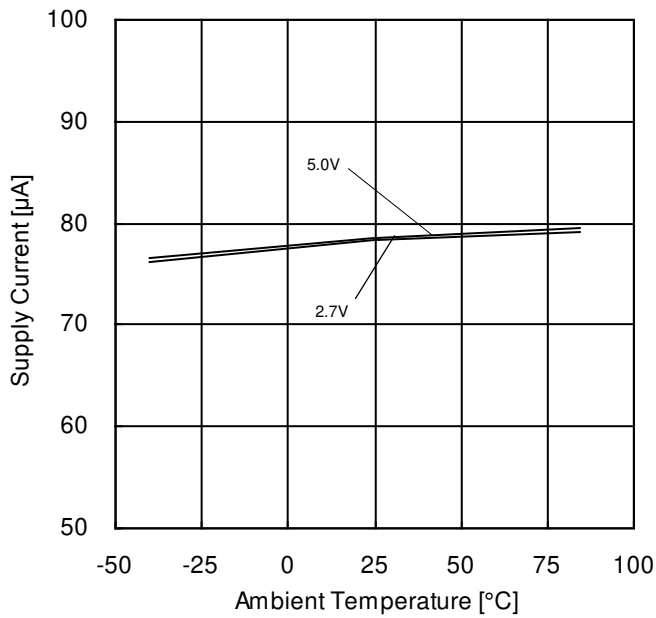

Figure 3. Supply Current vs Ambient Temperature

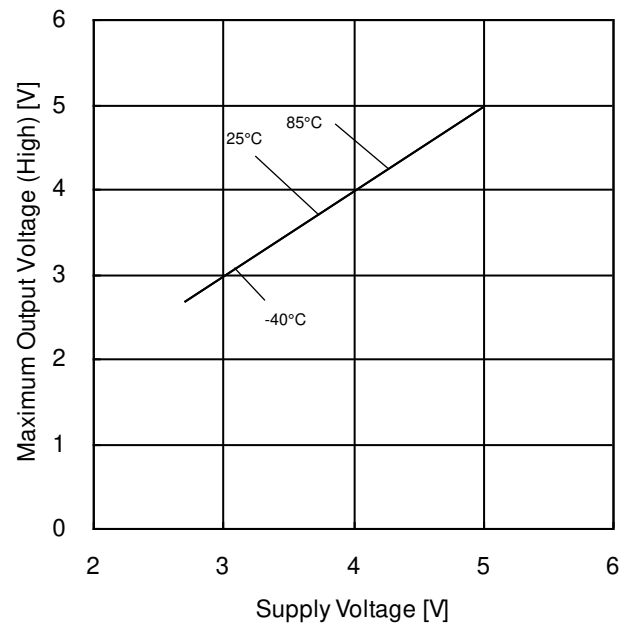

Figure 4. Maximum Output Voltage High vs Supply Voltage (RL=2kΩ)

(*)The data above is measurement value of typical sample, it is not guaranteed.

Typical Performance Curves – continued

OLMR341G

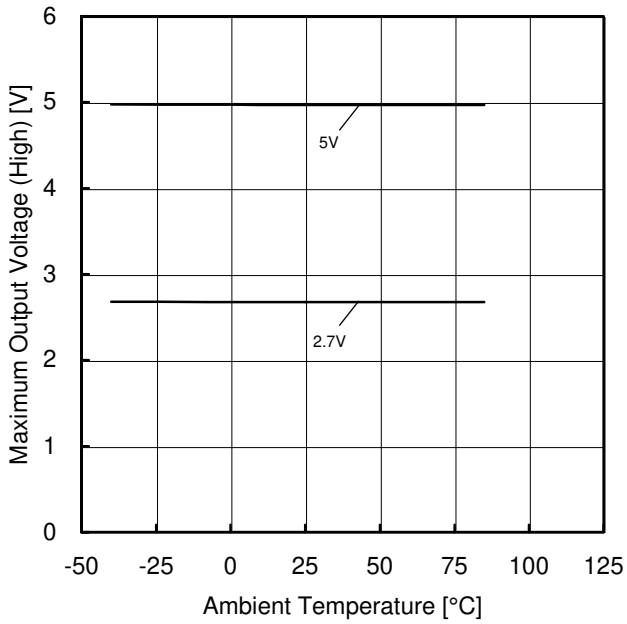

Figure 5. Maximum Output Voltage (High) vs Ambient Temperature (R_L=2kΩ)

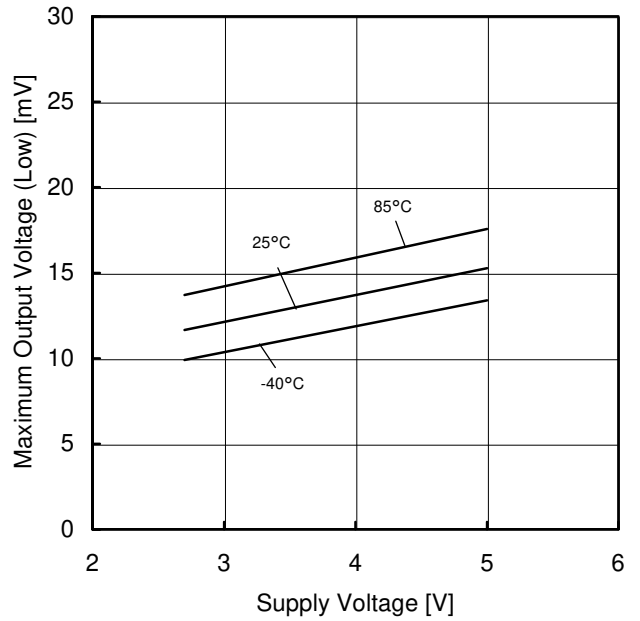

Figure 6. Maximum Output Voltage (Low) vs Supply Voltage (R_L=2kΩ)

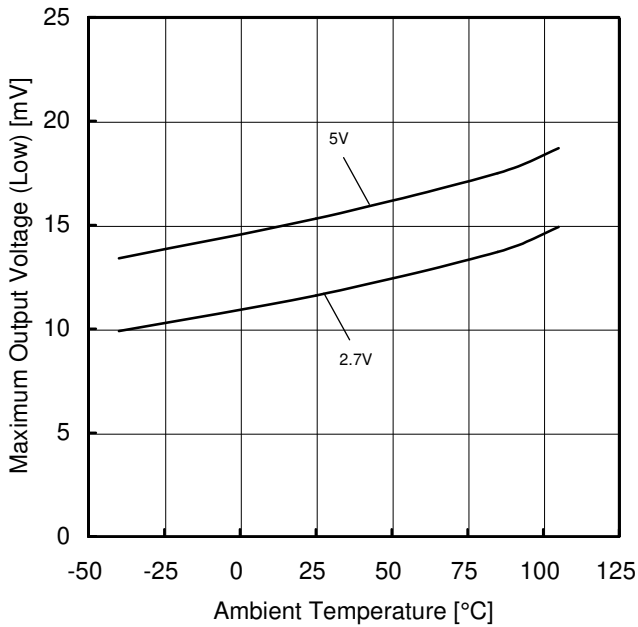

Figure 7. Maximum Output Voltage (Low) vs Ambient Temperature (R_L=2kΩ)

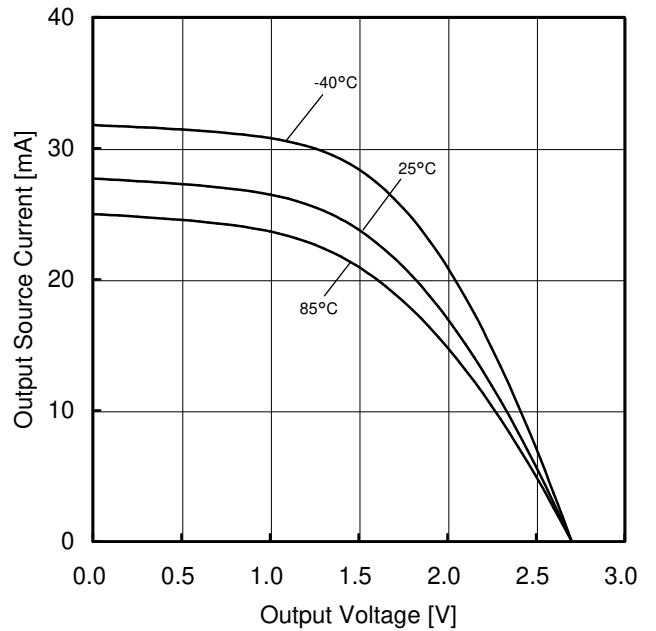

Figure 8. Output Source Current vs Output Voltage (V_{DD}=2.7V)

(*)The data above is measurement value of typical sample, it is not guaranteed.

Typical Performance Curves – continued

OLMR341G

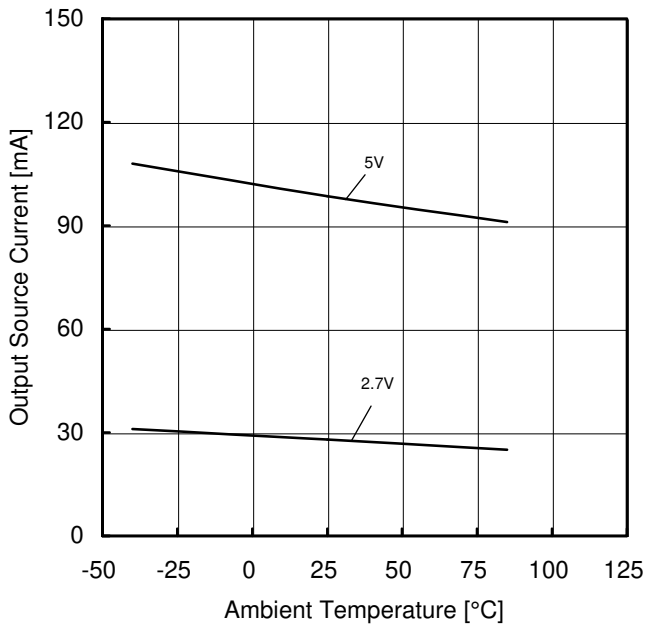

Figure 9. Output Source Current vs Ambient Temperature (OUT=0V)

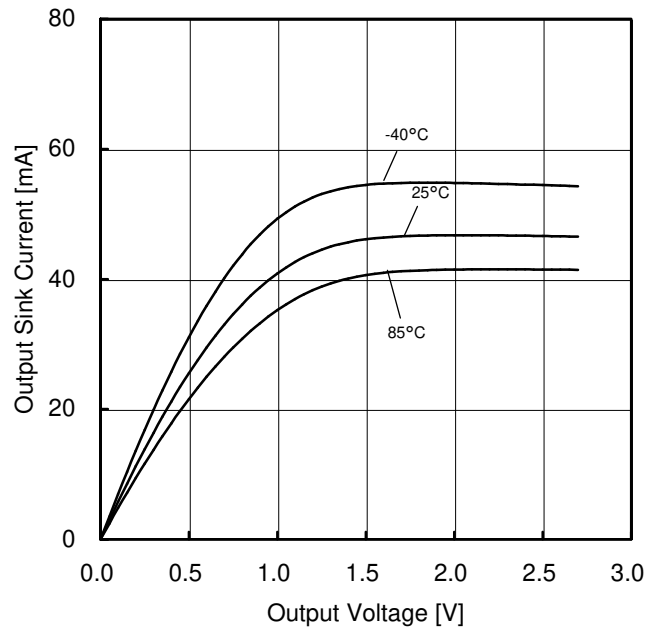

Figure 10. Output Sink Current vs Output Voltage (VDD=2.7V)

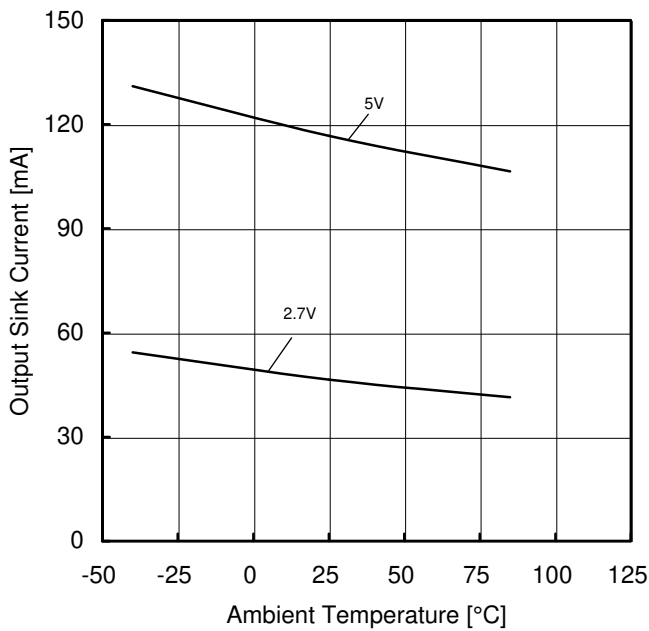

Figure 11. Output Sink Current vs Ambient Temperature (OUT=VDD)

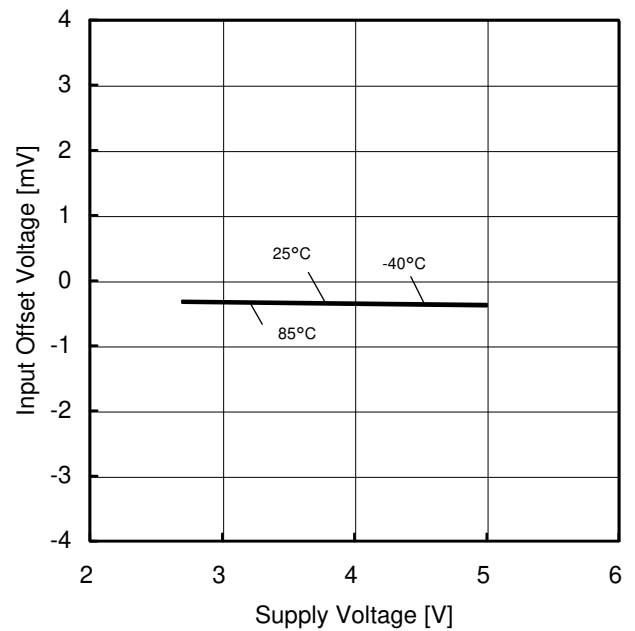

Figure 12. Input Offset Voltage vs Supply Voltage (VICM=VDD/2, EK=-VDD/2)

(*)The data above is measurement value of typical sample, it is not guaranteed.

Typical Performance Curves – continued

OLMR341G

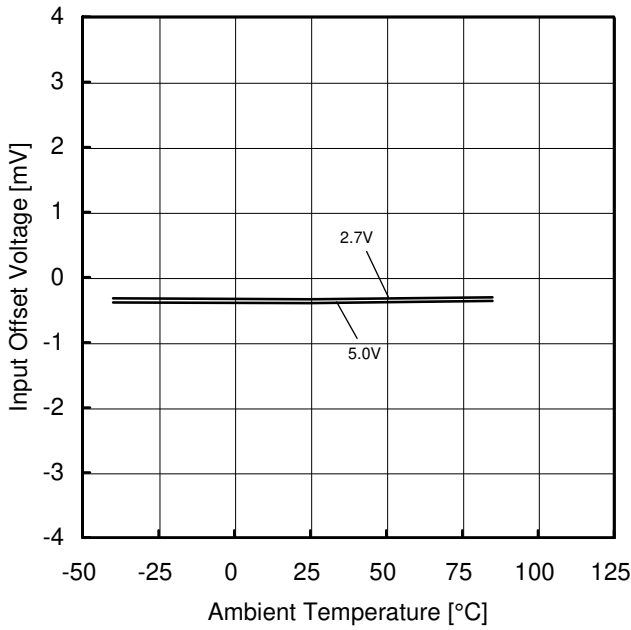

Figure 13. Input Offset Voltage vs Ambient Temperature ($V_{ICM}=V_{DD}/2$, $E_K=-V_{DD}/2$)

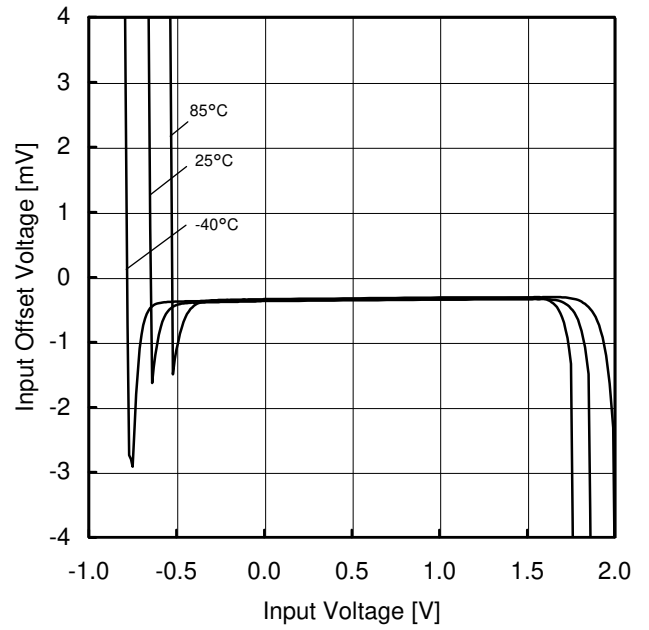

Figure 14. Input Offset Voltage vs Input Voltage ($V_{DD}=2.7V$, $E_K=-V_{DD}/2$)

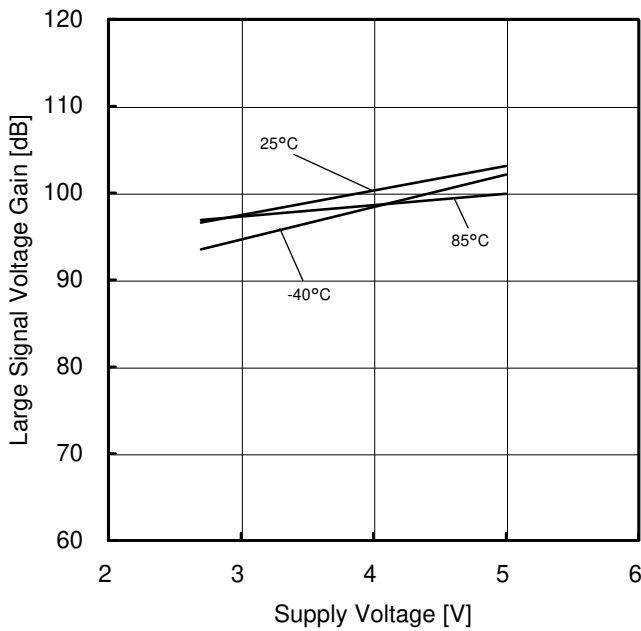

Figure 15. Large Signal Voltage Gain vs Supply Voltage

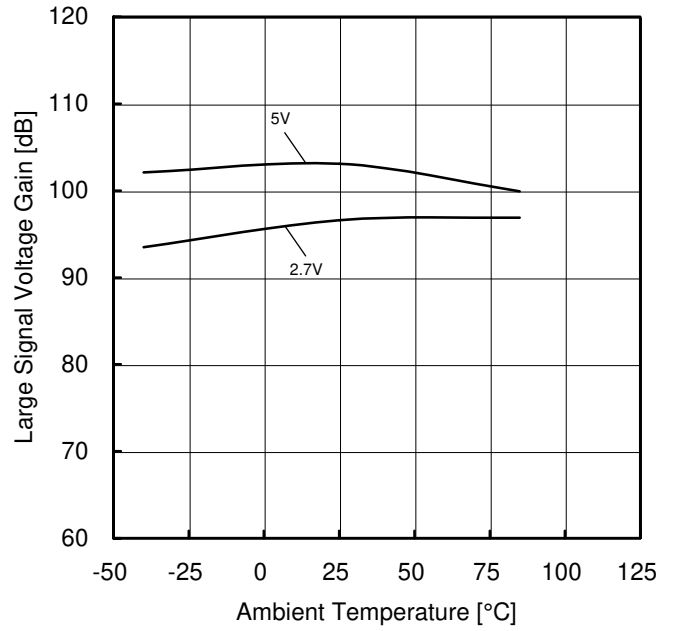

Figure 16. Large Signal Voltage Gain vs Ambient Temperature

(*The data above is measurement value of typical sample, it is not guaranteed.

Typical Performance Curves – continued

OLMR341G

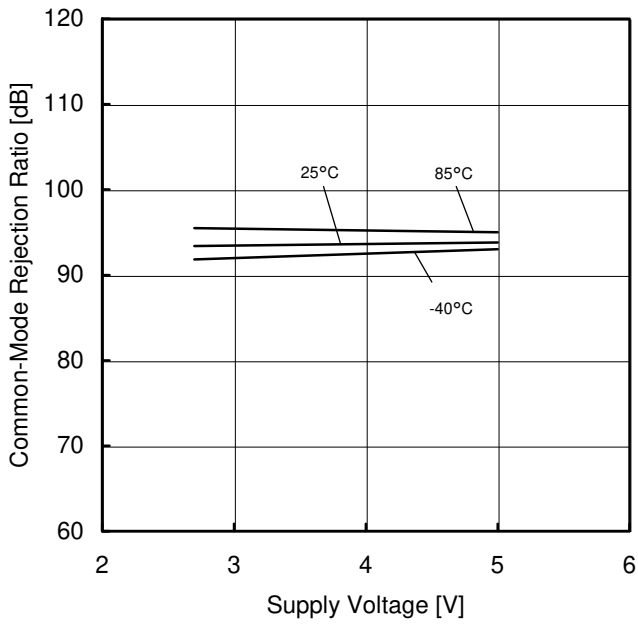

Figure 17. Common-Mode Rejection Ratio vs Supply Voltage (VDD=2.7V)

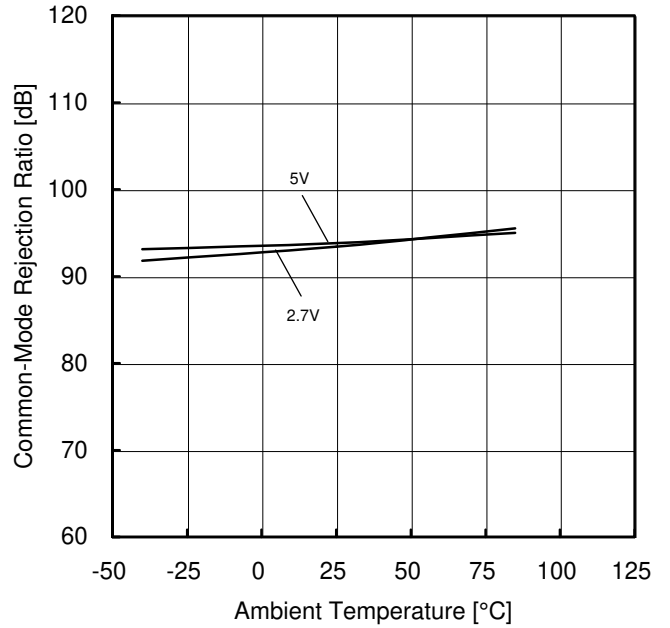

Figure 18. Common-Mode Rejection Ratio vs Ambient Temperature

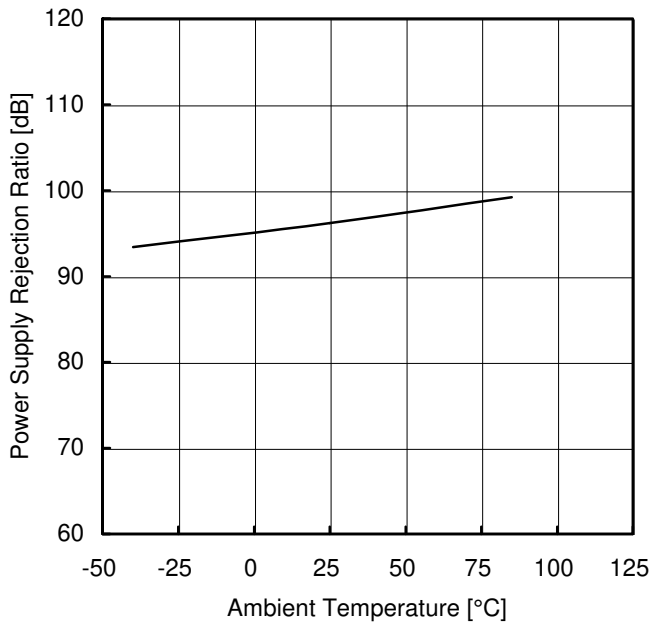

Figure 19. Power Supply Rejection Ratio vs Ambient Temperature (VDD=2.7V to 5.0V)

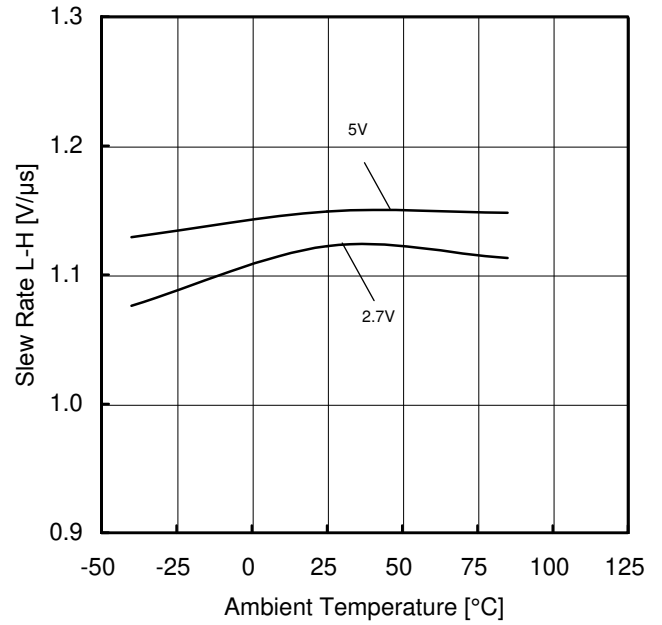

Figure 20. Slew Rate L-H vs Ambient Temperature (RL=10kΩ)

(*)The data above is measurement value of typical sample, it is not guaranteed.

Typical Performance Curves – continued

OLMR341G

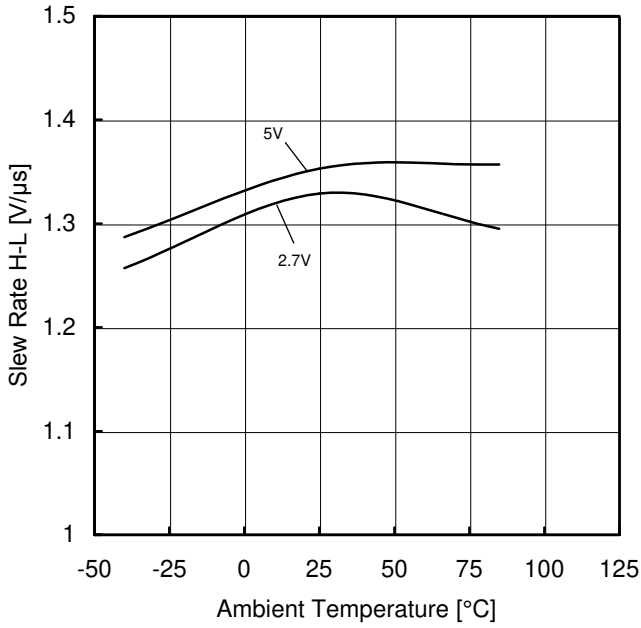

Figure 21. Slew Rate H-L vs Ambient Temperature (R_L=10kΩ)

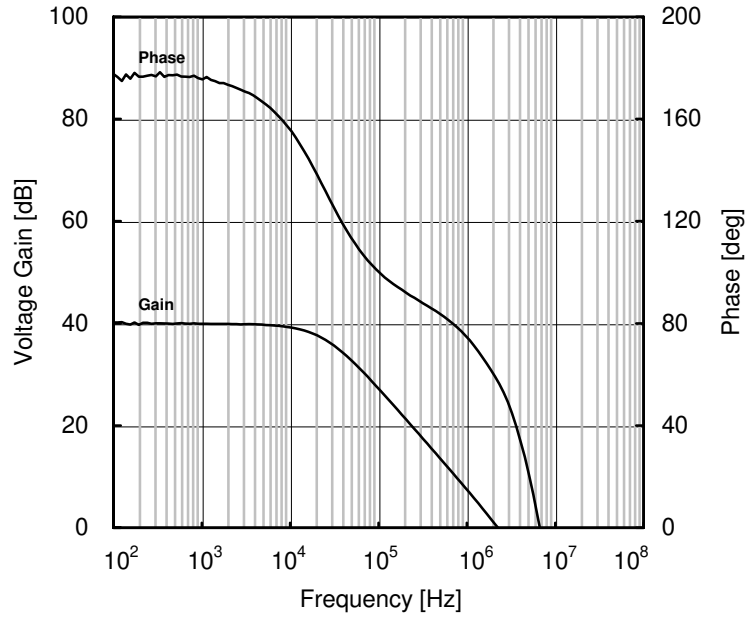

Figure 22. Voltage Gain • Phase vs Frequency (C=20pF)

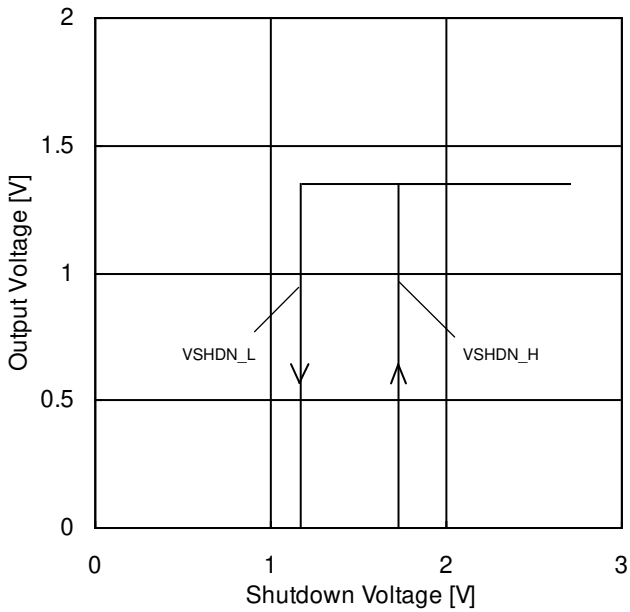

Figure 23. Shutdown Voltage vs Output Voltage (VDD=2.7V, Av=0dB, VIN=1.35V)

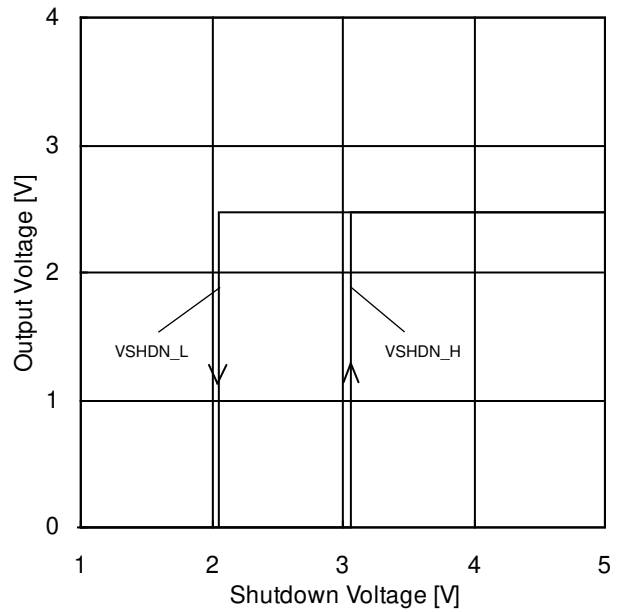

Figure 24. Shutdown Voltage vs Output Voltage (VDD=5V, Av=0dB, VIN=2.5V)

(*The data above is measurement value of typical sample, it is not guaranteed.

Typical Performance Curves – continued

OLMR342xxx

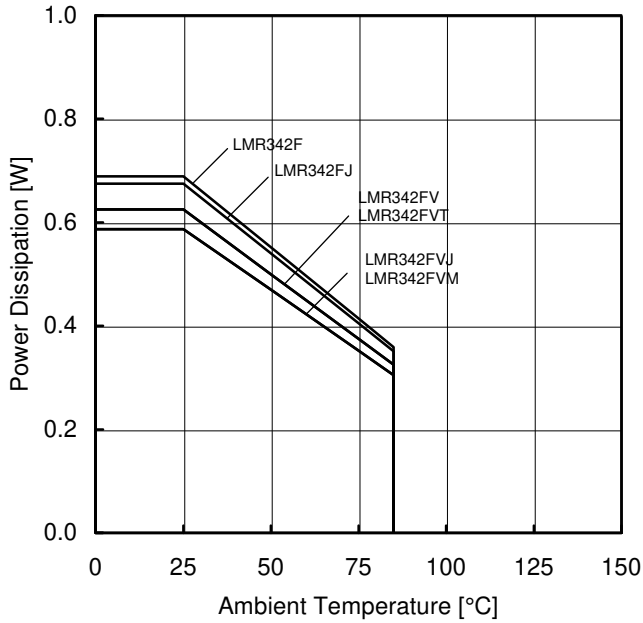

Figure 25. Power Dissipation vs Ambient Temperature (Derating Curve)

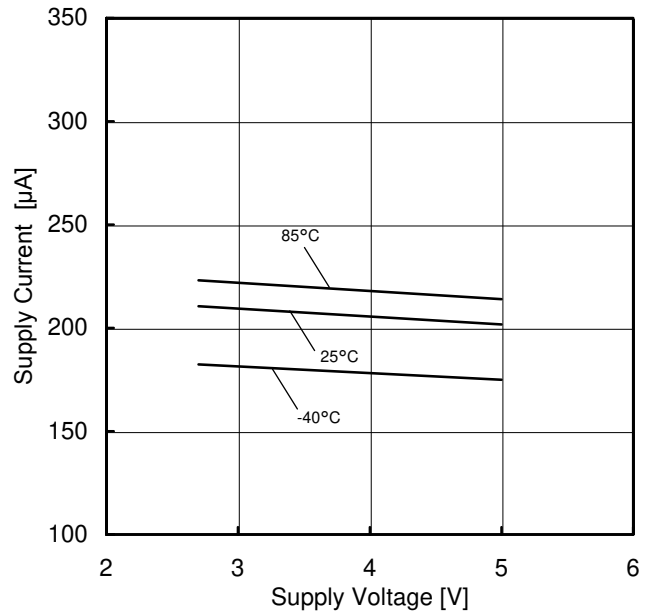

Figure 26. Supply Current vs Supply Voltage

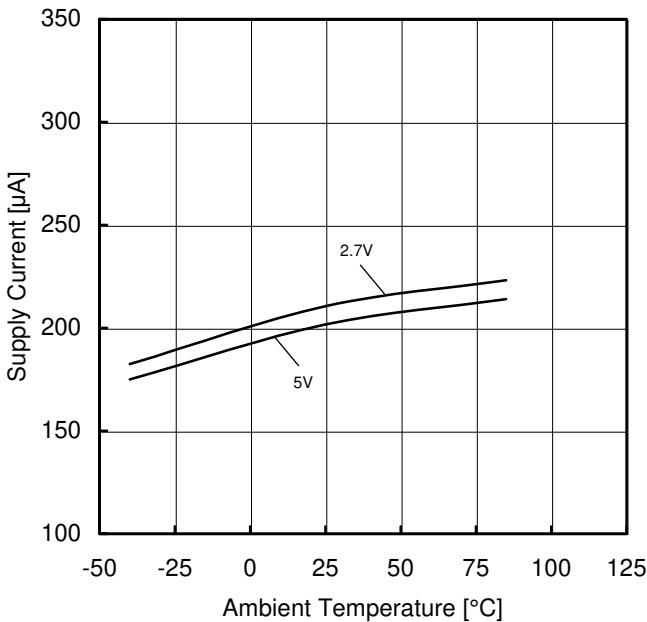

Figure 27. Supply Current vs Ambient Temperature

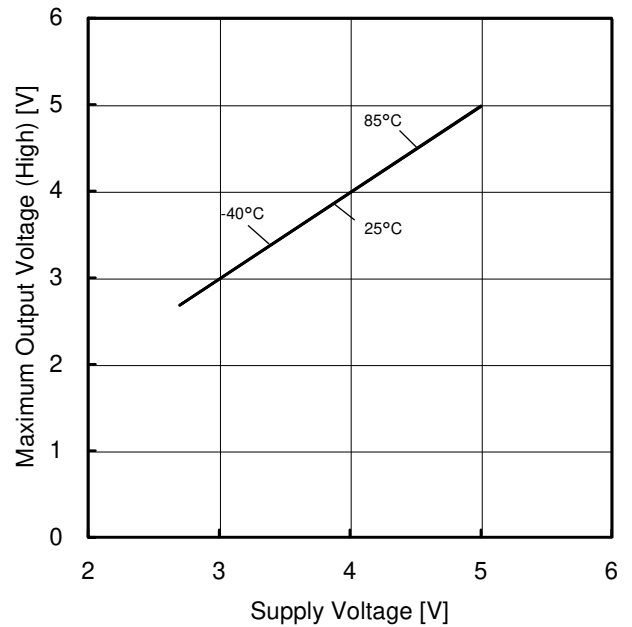

Figure 28. Maximum Output Voltage (High) vs Supply Voltage (RL=2kΩ)

(*)The data above is measurement value of typical sample, it is not guaranteed.

Typical Performance Curves – continued

OLMR342xxx

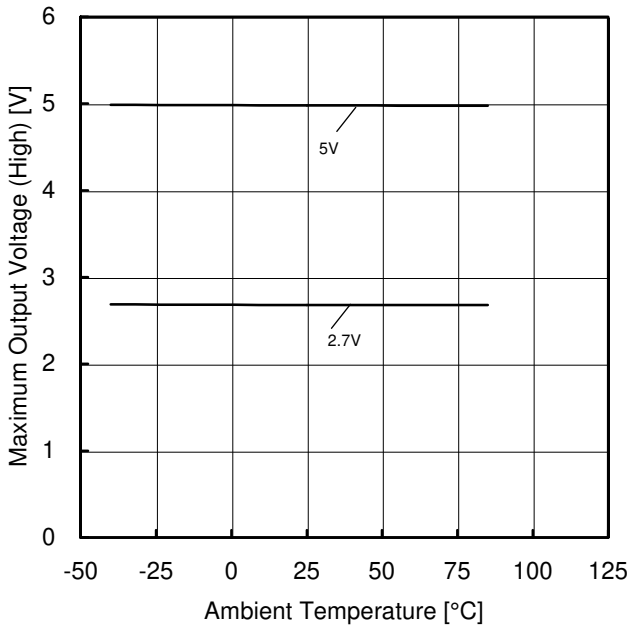

Figure 29. Maximum Output Voltage (High) vs Ambient Temperature (R_L=2kΩ)

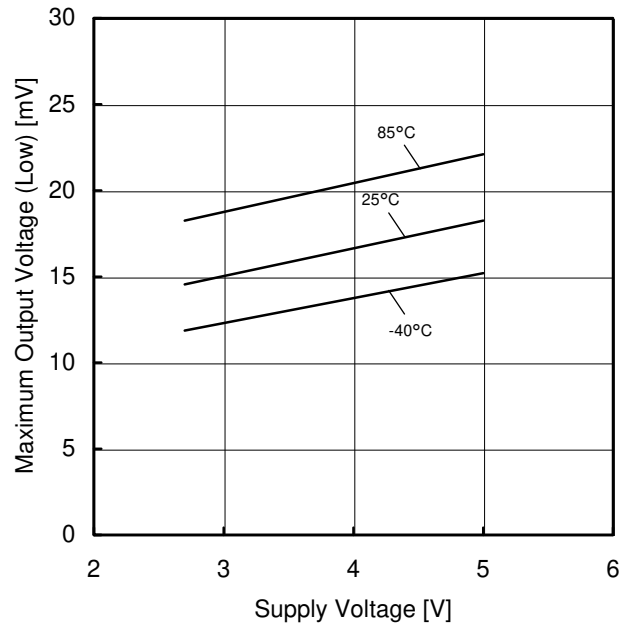

Figure 30. Maximum Output Voltage (Low) vs Supply Voltage (R_L=2kΩ)

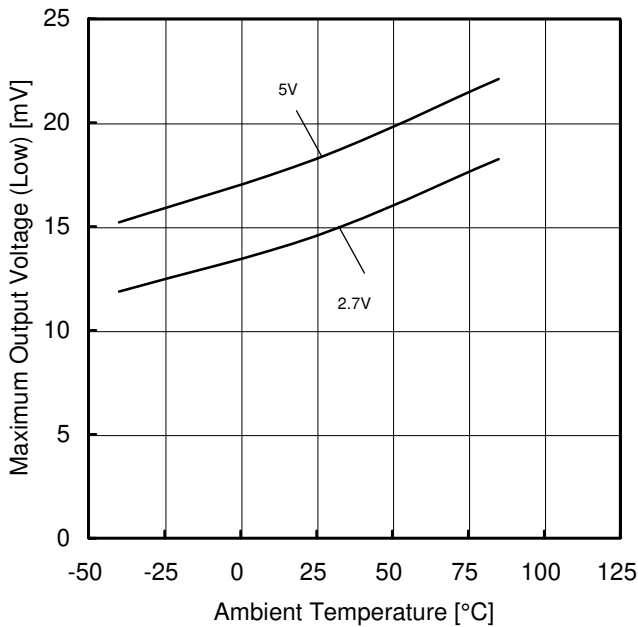

Figure 31. Maximum Output Voltage (Low) vs Ambient Temperature (R_L=2kΩ)

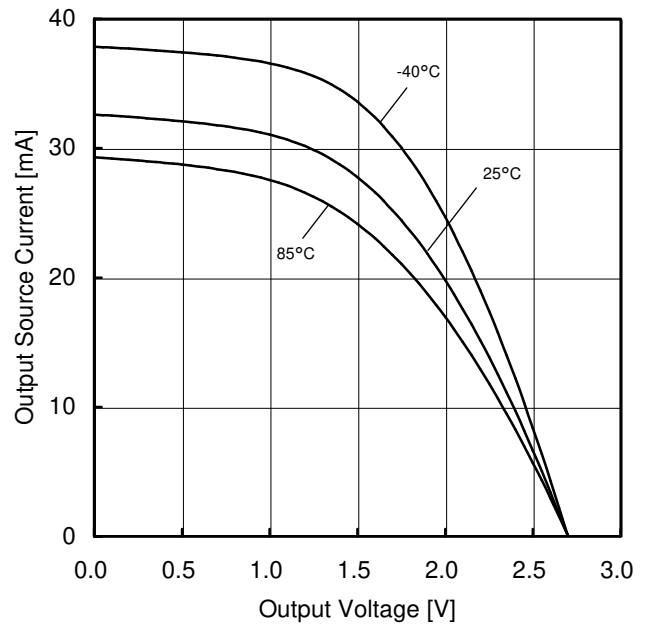

Figure 32. Output Source Current vs Output Voltage (V_{DD}=2.7V)

(*)The data above is measurement value of typical sample, it is not guaranteed.

Typical Performance Curves – continued

OLMR342xxx

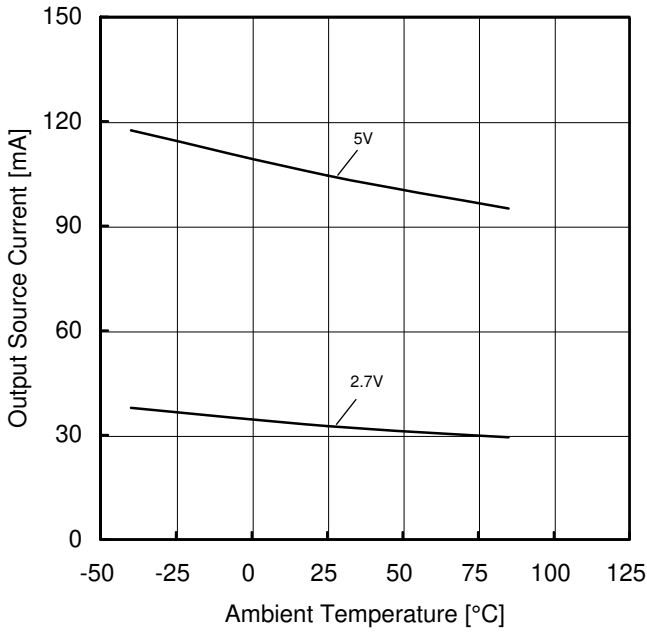

Figure 33. Output Source Current vs Ambient Temperature (OUT=0V)

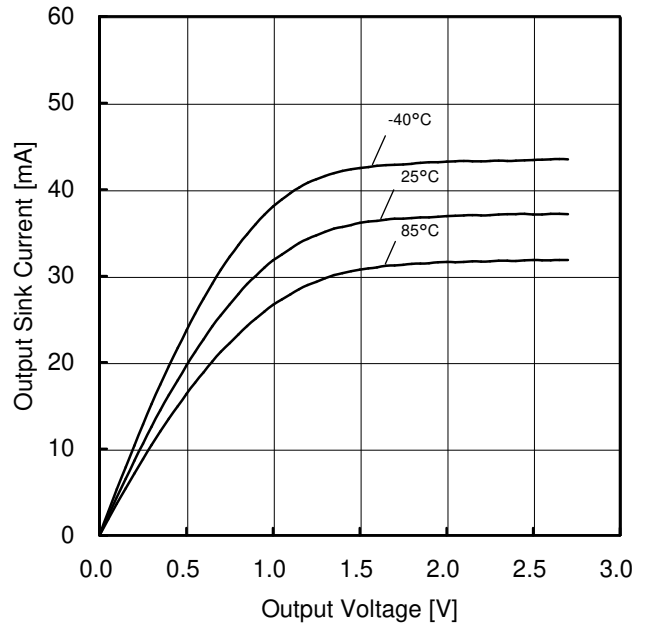

Figure 34. Output Sink Current vs Output Voltage (VDD=2.7V)

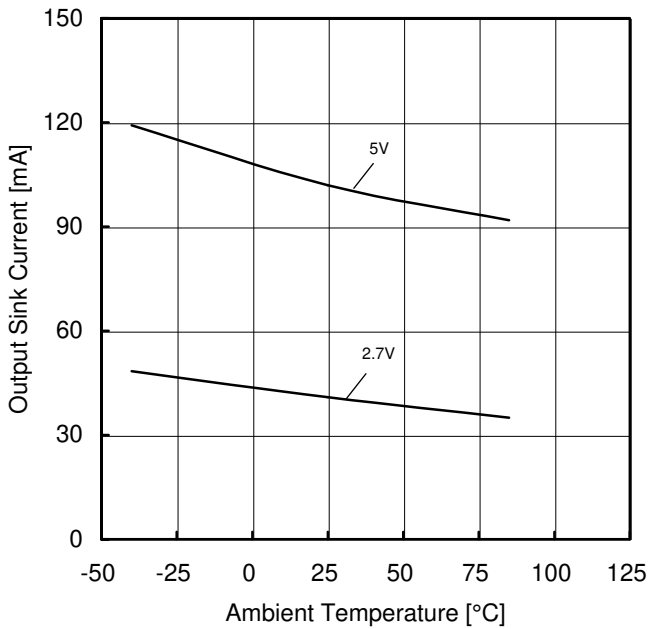

Figure 35. Output Sink Current vs Ambient Temperature (OUT=2.7V)

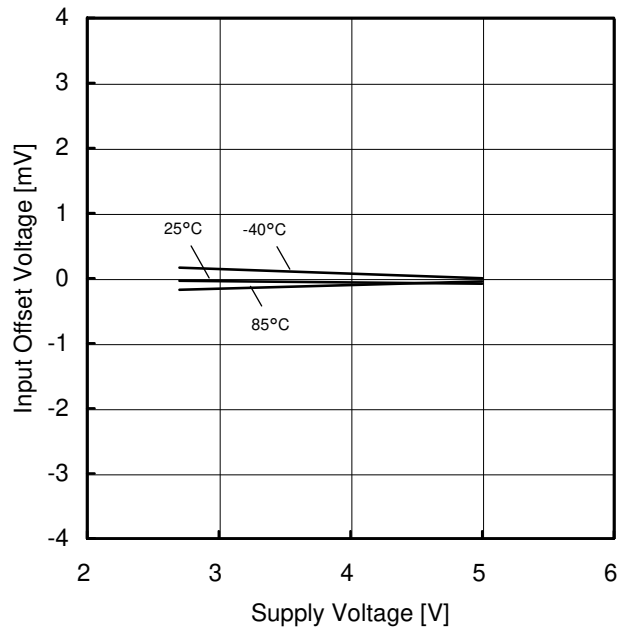

Figure 36. Input Offset Voltage vs Supply Voltage (VICM=VDD/2, EK=-VDD/2)

(*)The data above is measurement value of typical sample, it is not guaranteed.

Typical Performance Curves – continued

OLMR342xxx

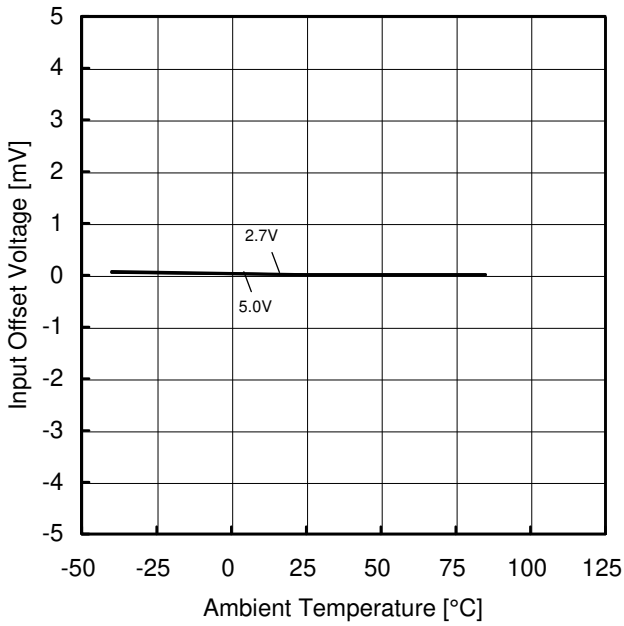

Figure 37. Input Offset Voltage vs Ambient Temperature
($V_{ICM}=V_{DD}/2$, $E_K=-V_{DD}/2$)

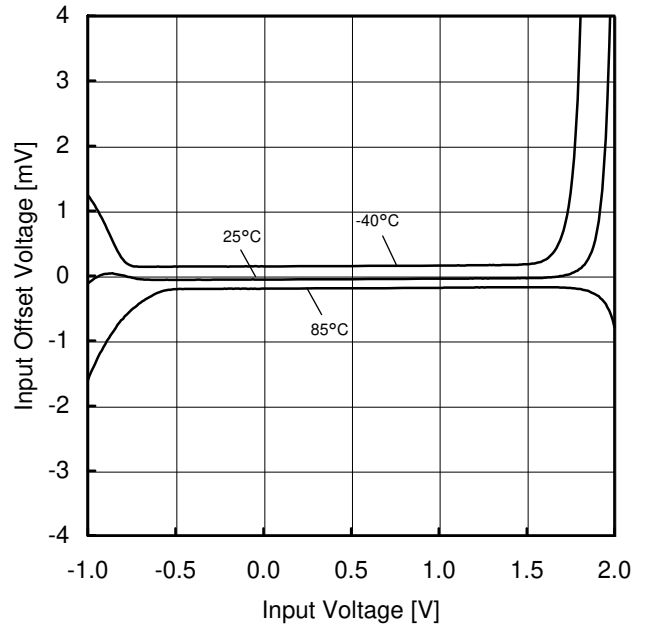

Figure 38. Input Offset Voltage vs Input Voltage
($V_{DD}=2.7V$, $E_K=-V_{DD}/2$)

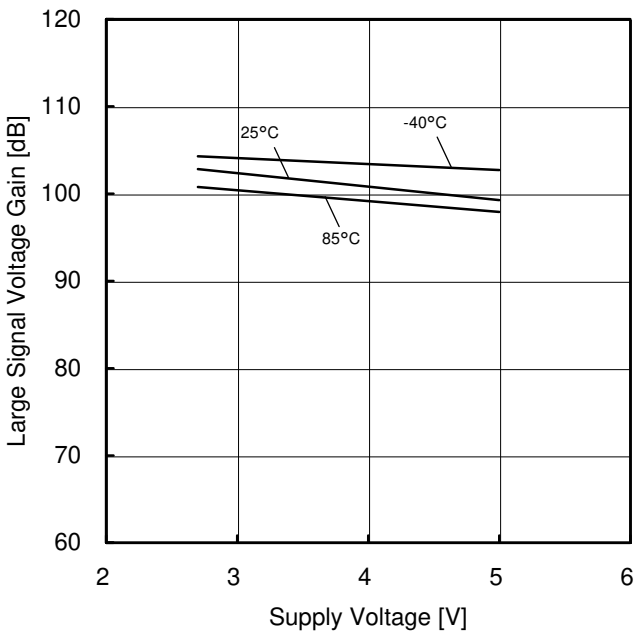

Figure 39. Large Signal Voltage Gain vs Supply Voltage

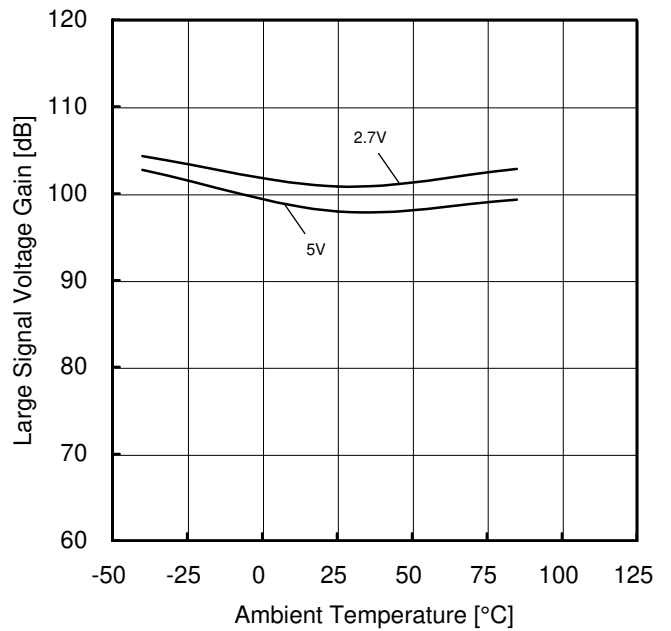

Figure 40. Large Signal Voltage Gain vs Ambient Temperature

(*)The data above is measurement value of typical sample, it is not guaranteed.

Typical Performance Curves – continued

OLMR342xxx

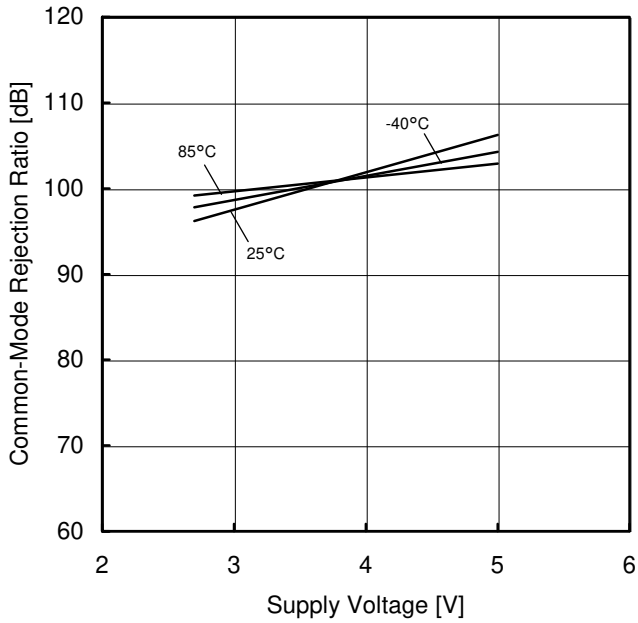

Figure 41. Common-Mode Rejection Ratio vs Supply Voltage (VDD=2.7V)

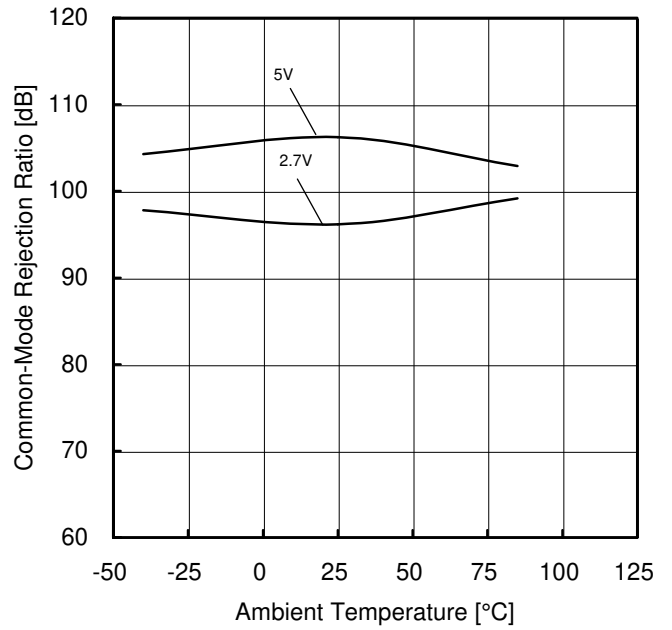

Figure 42. Common-Mode Rejection Ratio vs Ambient Temperature

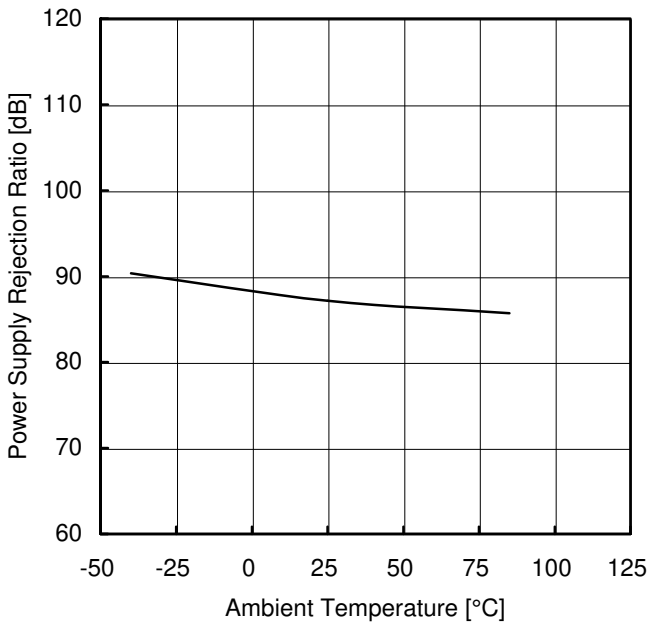

Figure 43. Power Supply Rejection Ratio vs Ambient Temperature (VDD=2.7V to 5.0V)

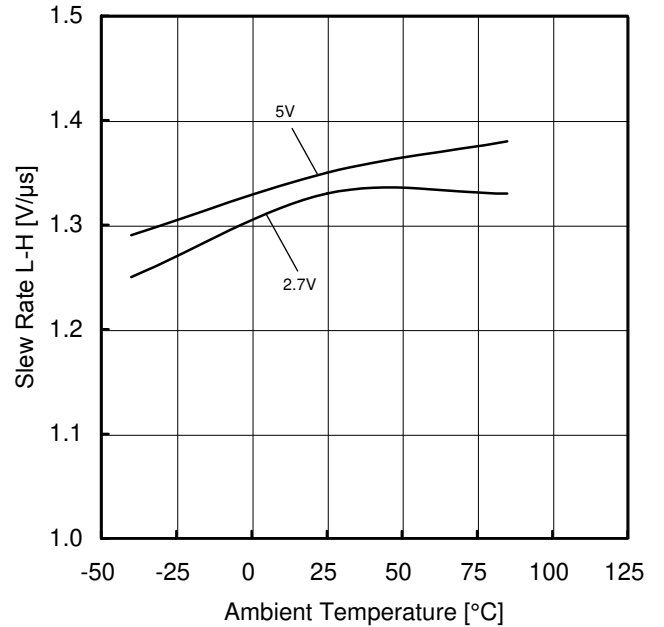

Figure 44. Slew Rate L-H vs Ambient Temperature (RL=10kΩ)

(*)The data above is measurement value of typical sample, it is not guaranteed.

Typical Performance Curves – continued

OLMR342xxx

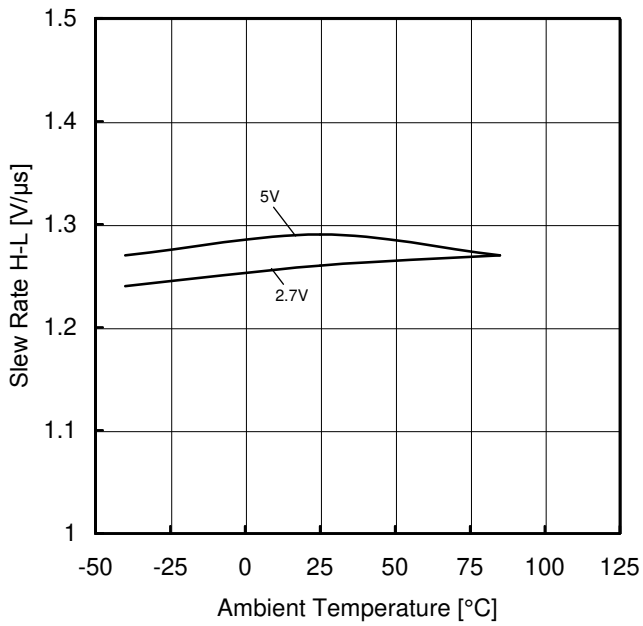

Figure 45. Slew Rate H-L vs Ambient Temperature (R_L=10kΩ)

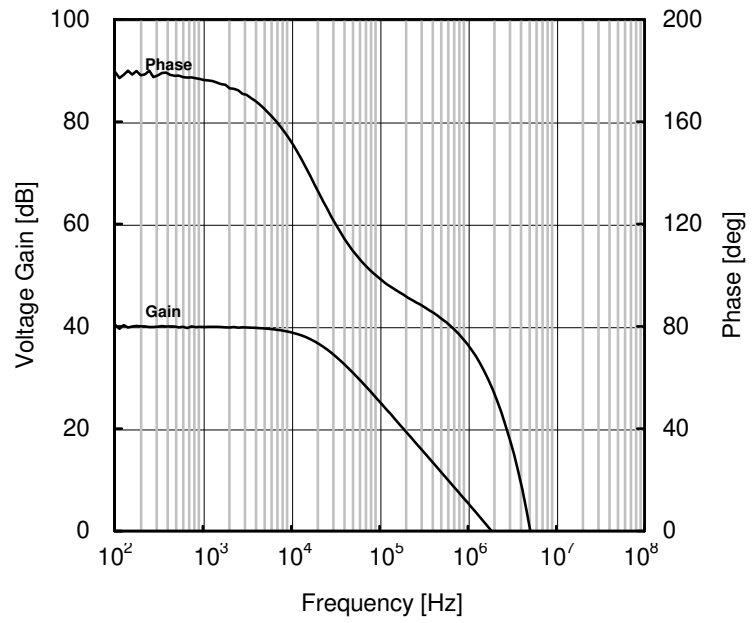

Figure 46. Voltage Gain · Phase vs Frequency (C=20pF)

(*)The data above is measurement value of typical sample, it is not guaranteed.

Typical Performance Curves – continued

OLMR344xxx

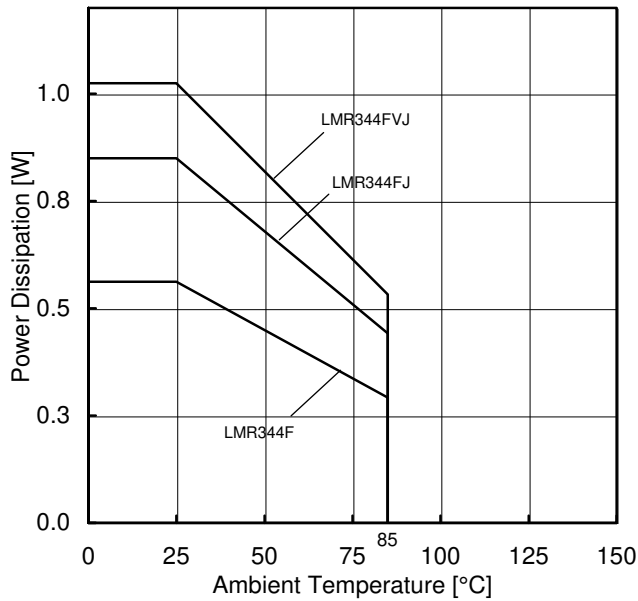

Figure 47. Power Dissipation vs Ambient Temperature (Derating Curve)

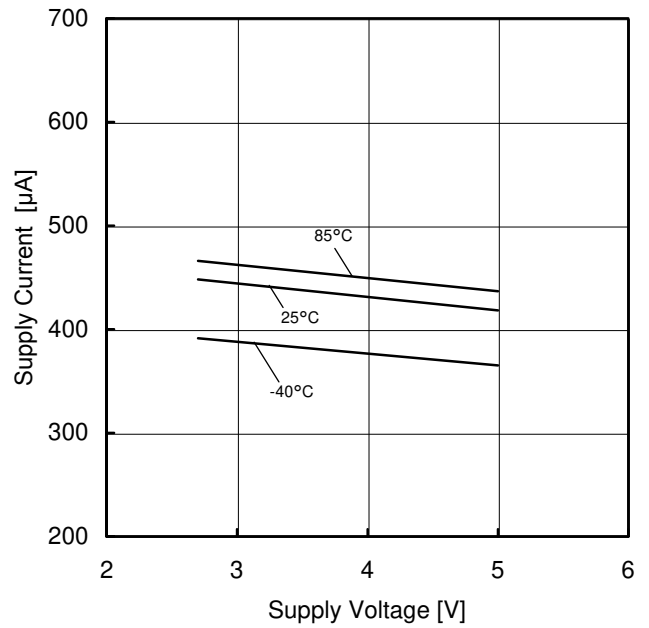

Figure 48. Supply Current vs Supply Voltage

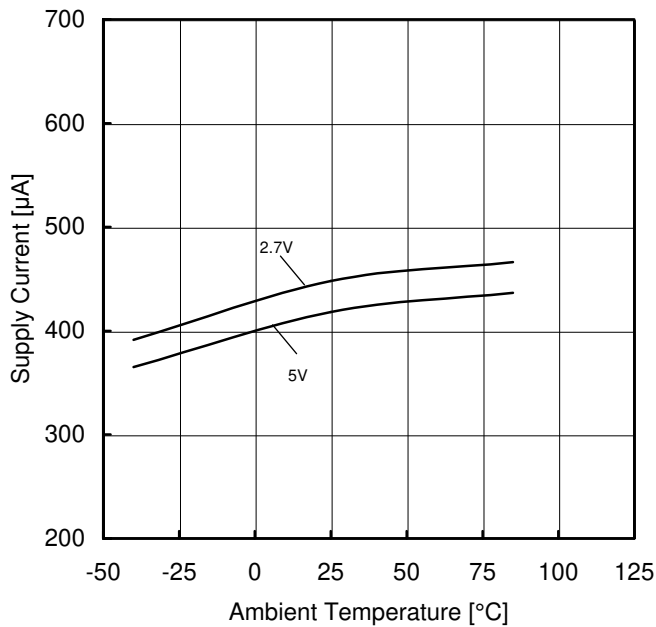

Figure 49. Supply Current vs Ambient Temperature

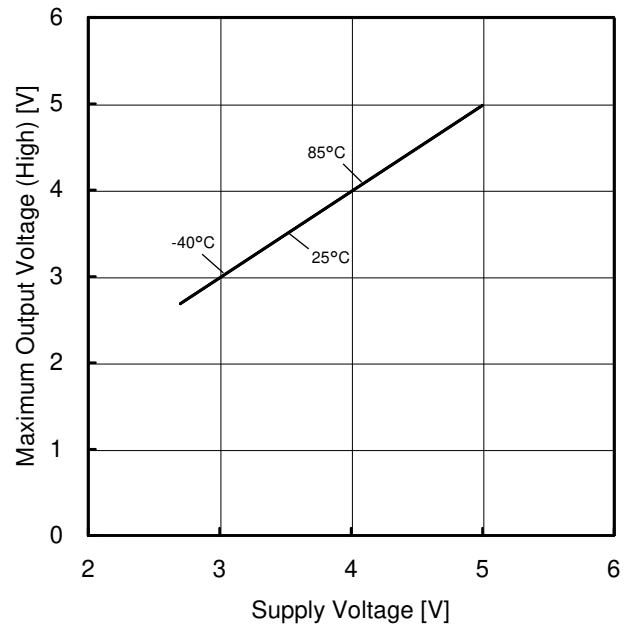

Figure 50. Maximum Output Voltage (High) vs Supply Voltage (RL=2kΩ)

(*)The data above is measurement value of typical sample, it is not guaranteed.