



Chipsmall Limited consists of a professional team with an average of over 10 year of expertise in the distribution of electronic components. Based in Hongkong, we have already established firm and mutual-benefit business relationships with customers from,Europe,America and south Asia,supplying obsolete and hard-to-find components to meet their specific needs.

With the principle of “Quality Parts,Customers Priority,Honest Operation,and Considerate Service”,our business mainly focus on the distribution of electronic components. Line cards we deal with include Microchip,ALPS,ROHM,Xilinx,Pulse,ON,Everlight and Freescale. Main products comprise IC,Modules,Potentiometer,IC Socket,Relay,Connector.Our parts cover such applications as commercial,industrial, and automotives areas.

We are looking forward to setting up business relationship with you and hope to provide you with the best service and solution. Let us make a better world for our industry!



Contact us

Tel: +86-755-8981 8866 Fax: +86-755-8427 6832

Email & Skype: info@chipsmall.com Web: www.chipsmall.com

Address: A1208, Overseas Decoration Building, #122 Zhenhua RD., Futian, Shenzhen, China



Operational Amplifiers

Input/Output Full Swing Low Power Operational Amplifiers

LMR981G LMR982FVM LMR931G LMR932xxx LMR934xxx

General Description

LMR981G/LMR982FVM/LMR931G/LMR932xxx/LMR934xxx are input/output full swing operational amplifiers. LMR981G/LMR982FVM have the shutdown function. They have the features of low operating supply voltage, low supply current and low input bias current. These are suitable for portable equipment and battery monitoring.

Features

- Low Operating Supply Voltage
- Input/Output Full Swing
- High Large Signal Voltage Gain
- Low Input Bias Current
- Low Supply Current
- Low Input Offset Voltage

Applications

- Portable Equipment
- Low Voltage Application
- Active Filter
- Supply-Current Monitoring
- Battery Monitoring

Key Specifications

- Operating Supply Voltage (Single Supply): +1.8V to +5.0V
- Voltage Gain (VDD=5V, R_L=600Ω): 101dB(Typ)
- Operating Temperature Range: -40°C to +85°C
- Turn on Time from Shutdown(VDD=1.8V): 19μs (Typ)
- Input Offset Voltage(T_A=25°C):
 - LMR981G(Single) 4mV(Max)
 - LMR931G(Single) 4mV(Max)
 - LMR982FVM(Dual) 5.5mV(Max)
 - LMR932xxx(Dual) 5.5mV(Max)
 - LMR934xxx(Quad) 5.5mV(Max)
- Input Bias Current: 5nA (Typ)

Package

Package	W(Typ) xD(Typ) xH(Max)
SSOP5	2.90mm x 2.80mm x 1.25mm
SSOP6	2.90mm x 2.80mm x 1.25mm
MSOP8	2.90mm x 4.00mm x 0.90mm
MSOP10	2.90mm x 4.00mm x 0.90mm
TSSOP-B8J	3.00mm x 4.90mm x 1.10mm
TSSOP-B8	3.00mm x 6.40mm x 1.20mm
SSOP-B8	3.00mm x 6.40mm x 1.35mm
SOP-J8	4.90mm x 6.00mm x 1.65mm
SOP8	5.00mm x 6.20mm x 1.71mm
TSSOP-B14J	5.00mm x 6.40mm x 1.20mm
SSOP-B14	5.00mm x 6.40mm x 1.35mm
SOP-J14	8.65mm x 6.00mm x 1.65mm
SOP14	8.70mm x 6.20mm x 1.71mm

Simplified Schematic

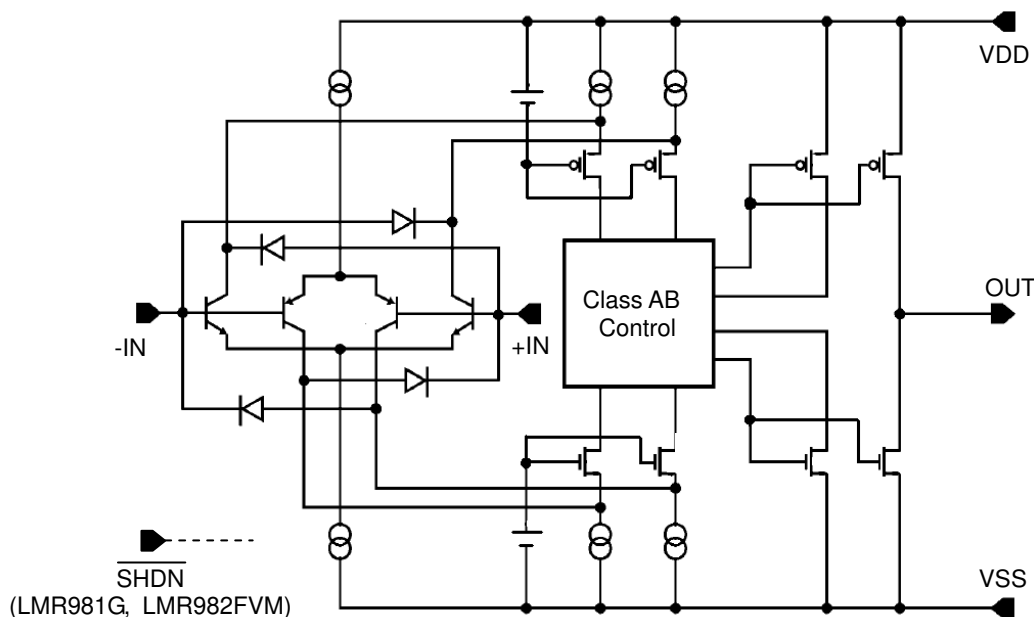
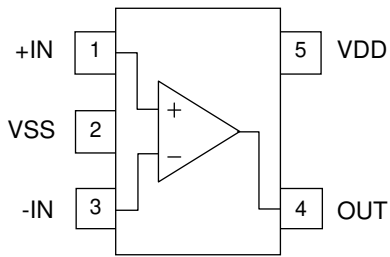

Figure 1. Simplified Schematic (1 Channel Only)

○Product structure : Silicon monolithic integrated circuit ○This product has no designed protection against radioactive rays.

Pin Configuration

LMR931G : SSOP5



Pin No.	Pin Name
1	+IN
2	VSS
3	-IN
4	OUT
5	VDD

LMR981G : SSOP6

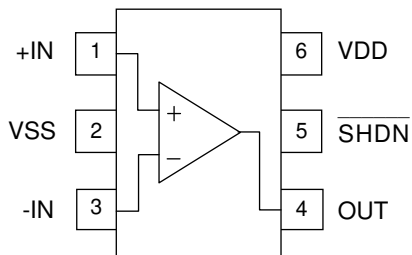

Pin No.	Pin Name
1	+IN
2	VSS
3	-IN
4	OUT
5	SHDN
6	VDD

- LMR932F : SOP8
- LMR932FJ : SOP-J8
- LMR932FV : SSOP-B8
- LMR932FVT : TSSOP-B8
- LMR932FVM : MSOP8
- LMR932FVJ : TSSOP-B8J

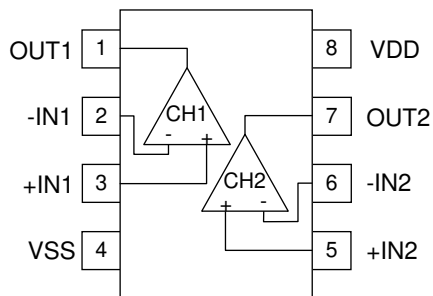

Pin No.	Pin Name
1	OUT1
2	-IN1
3	+IN1
4	VSS
5	+IN2
6	-IN2
7	OUT2
8	VDD

LMR934F : SOP14
 LMR934FJ : SOP-J14
 LMR934FV : SSOP-B14
 LMR934FVJ : TSSOP-B14J

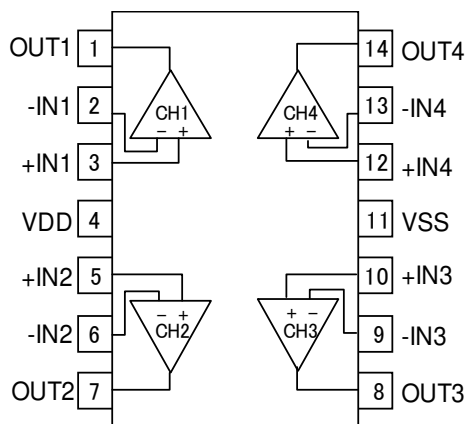

Pin No.	Pin Name
1	OUT1
2	-IN1
3	+IN1
4	VDD
5	+IN2
6	-IN2
7	OUT2
8	OUT3
9	-IN3
10	+IN3
11	VSS
12	+IN4
13	-IN4
14	OUT4

LMR982FVM : MSOP10

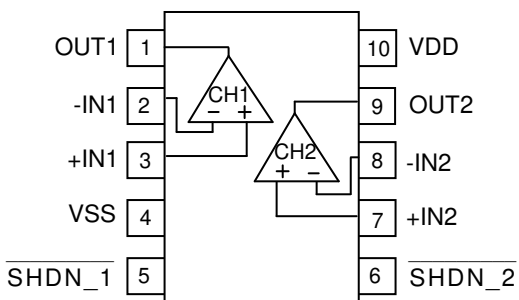

Pin No.	Pin Name
1	OUT1
2	-IN1
3	+IN1
4	VSS
5	SHDN_1
6	SHDN_2
7	+IN2
8	-IN2
9	OUT2
10	VDD

Package						
SSOP5	SSOP6	SOP8	SOP-J8	SSOP-B8	TSSOP-B8	MSOP8
LMR931G	LMR981G	LMR932F	LMR932FJ	LMR932FV	LMR932FVT	LMR932FVM
Package						
TSSOP-B8J	MSOP10	SOP14	SOP-J14	SSOP-B14	TSSOP-B14J	-
LMR932FVJ	LMR982FVM	LMR934F	LMR934FJ	LMR934FV	LMR934FVJ	-

Shutdown (LMR981G, LMR982FVM)

Pin	Input Condition	Shutdown Function
SHDN	VSS	ON
	VDD	OFF

Note: Please refer to Electrical Characteristics regarding the turn on and off voltage.

Ordering Information

L M R 9 x x x x x										-	X X	
Part Number					Package					Packaging and forming specification		
LMR931G					G : SSOP5					TR: Embossed tape and reel		
LMR981G					G : SSOP6					(SSOP5/SSOP6/MSOP8/MSOP10)		
LMR932F					F : SOP8					E2: Embossed tape and reel		
LMR932FJ					FJ : SOP-J8					(SOP8/SOP14/SOP-J8/SOP-J14		
LMR932FV					FV : SSOP-B8					SSOP-B8/SSOP-B14/TSSOP-B8/		
LMR932FVT					FVT : TSSOP-B8					TSSOP-B8J/TSSOP-B14J)		
LMR932FVM					FVM : MSOP8							
LMR932FVJ					FVJ : TSSOP-B8J							
LMR982FVM					FVM : MSOP10							
LMR934F					F : SOP14							
LMR934FJ					FJ : SOP-J14							
LMR934FV					FV : SSOP-B14							
LMR934FVJ					FVJ : TSSOP-B14J							

Lineup

T _{opr}	Package		Operable Part Number
-40°C to +85°C	SSOP5	Reel of 3000	LMR931G-TR
	SSOP6	Reel of 3000	LMR981G-TR
	MSOP10	Reel of 3000	LMR982FVM-TR
	SOP8	Reel of 2500	LMR932F-E2
	SOP-J8	Reel of 2500	LMR932FJ-E2
	SSOP-B8	Reel of 2500	LMR932FV-E2
	TSSOP-B8	Reel of 3000	LMR932FVT-E2
	MSOP8	Reel of 3000	LMR932FVM-TR
	TSSOP-B8J	Reel of 2500	LMR932FVJ-E2
	SOP14	Reel of 2500	LMR934F-E2
	SOP-J14	Reel of 2500	LMR934FJ-E2
	SSOP-B14	Reel of 2500	LMR934FV-E2
	TSSOP-B14J	Reel of 2500	LMR934FVJ-E2

Absolute Maximum Ratings (T_A=25°C)

Parameter	Symbol	Rating					Unit
		LMR981G	LMR931G	LMR932xxx	LMR934xxx	LMR982FVM	
Supply Voltage	VDD-VSS	+7					V
Power Dissipation	P _D	SSOP5	-	0.67 ^(Note 1,9)	-	-	-
		SSOP6	0.67 ^(Note 1,9)	-	-	-	-
		SOP8	-	-	0.68 ^(Note 2,9)	-	-
		SOP-J8	-	-	0.67 ^(Note 1,9)	-	-
		SSOP-B8	-	-	0.62 ^(Note 5,9)	-	-
		TSSOP-B8	-	-	0.62 ^(Note 5,9)	-	-
		MSOP8	-	-	0.58 ^(Note 4,9)	-	-
		TSSOP-B8J	-	-	0.58 ^(Note 4,9)	-	-
		MSOP10	-	-	-	-	0.58 ^(Note 4,9)
		SOP14	-	-	-	0.56 ^(Note 3,9)	-
		SOP-J14	-	-	-	1.02 ^(Note 8,9)	-
		SSOP-B14	-	-	-	0.87 ^(Note 7,9)	-
TSSOP-B14J	-	-	-	0.85 ^(Note 6,9)	-		
Differential Input Voltage ^(Note 10)	V _{ID}	VDD to VSS					V
Input Common-mode Voltage Range	V _{ICM}	(VSS-0.3) to (VDD+0.3)					V
Input Current ^(Note 11)	I _I	±10					mA
Operating Voltage	V _{opr}	+1.8 to +5.0					V
Operating Temperature	T _{opr}	- 40 to +85					°C
Storage Temperature	T _{stg}	- 55 to +150					°C
Maximum Junction Temperature	T _{Jmax}	+150					°C

(Note 1) To use at temperature above T_A=25°C reduce 5.4mW/°C.

(Note 2) To use at temperature above T_A=25°C reduce 5.5mW/°C.

(Note 3) To use at temperature above T_A=25°C reduce 4.5mW/°C.

(Note 4) To use at temperature above T_A=25°C reduce 4.7mW/°C.

(Note 5) To use at temperature above T_A=25°C reduce 5.0mW/°C.

(Note 6) To use at temperature above T_A=25°C reduce 6.8mW/°C.

(Note 7) To use at temperature above T_A=25°C reduce 7.0mW/°C.

(Note 8) To use at temperature above T_A=25°C reduce 8.2mW/°C.

(Note 9) Mounted on a FR4 glass epoxy PCB 70mm×70mm×1.6mm (Copper foil area less than 3%).

(Note 10) The voltage difference between inverting input and non-inverting input is the differential input voltage. Then input terminal voltage is set to more than VSS.

(Note 11) An excessive input current will flow when input voltages of more than VDD+0.6V or less than VSS-0.6V are applied. The input current can be set to less than the rated current by adding a limiting resistor.

Caution: Operating the IC over the absolute maximum ratings may damage the IC. The damage can either be a short circuit between pins or an open circuit between pins and the internal circuitry. Therefore, it is important to consider circuit protection measures, such as adding a fuse, in case the IC is operated over the absolute maximum ratings.

Electrical Characteristics:

OLMR981G, LMR931G (Unless otherwise specified VDD=+1.8V, VSS=0V, SHDN=VDD)

Parameter	Symbol	Temperature Range	Limit			Unit	Conditions
			Min	Typ	Max		
Input Offset Voltage (Note 12)	V _{IO}	25°C	-	1	4	mV	VDD=1.8V to 5.0V
		Full Range	-	-	6		
Input Offset Voltage Drift	ΔV _{IO} /ΔT	25°C	-	5.5	-	μV/°C	-
Input Offset Current (Note 12)	I _{IO}	25°C	-	5	30	nA	-
Input Bias Current (Note 12)	I _B	25°C	-	5	35	nA	-
Supply Current (Note 13)	I _{DD}	25°C	-	75	180	μA	A _V =0dB, +IN=0.9V
		Full range	-	-	205		
Shutdown Current (Note 14)	I _{DD_SD}	25°C	-	0.15	1	μA	SHDN=0V
Maximum Output Voltage(High)	V _{OH}	25°C	1.65	1.72	-	V	R _L =600Ω, V _{RL} =VDD/2
			1.75	1.77	-		R _L =2kΩ, V _{RL} =VDD/2
Maximum Output Voltage(Low)	V _{OL}	25°C	-	77	105	mV	R _L =600Ω, V _{RL} =VDD/2
			-	24	35		R _L =2kΩ, V _{RL} =VDD/2
Large Signal Voltage Gain	A _V	25°C	-	96	-	dB	R _L =600Ω, V _{RL} =VDD/2
			80	100	-		R _L =2kΩ, V _{RL} =VDD/2
Input Common-mode Voltage Range	V _{ICM}	25°C	VSS	-	VDD	V	VSS to VDD
		Full range	VSS+0.2	-	VDD-0.2		
Common-mode Rejection Ratio	CMRR	25°C	60	94	-	dB	V _{ICM} =0.5V
Power Supply Rejection Ratio	PSRR	25°C	75	85	-	dB	VDD=1.8V to 5.0V V _{ICM} =0.5V
Output Source Current (Note 15)	I _{SOURCE}	25°C	4	8	-	mA	OUT=0V, Short Current
Output Sink Current (Note 15)	I _{SINK}	25°C	7	9	-	mA	OUT=1.8V Short Current
Slew Rate	SR	25°C	-	0.35	-	V/μs	C _L =25pF
Gain Bandwidth	GBW	25°C	-	1.4	-	MHz	C _L =25pF, A _V =40dB f=100kHz
Unity Gain Frequency	f _T	25°C	-	1.4	-	MHz	C _L =25pF, A _V =40dB
Phase Margin	θ	25°C	-	50	-	deg	C _L =25pF, A _V =40dB
Gain Margin	GM	25°C	-	7	-	dB	C _L =25pF, A _V =40dB
Input Referred Noise Voltage	V _N	25°C	-	6.5	-	μVrms	A _V =40dB, DIN-AUDIO
			-	50	-	nV/√Hz	f=10kHz
Total Harmonic Distortion + Noise	THD+N	25°C	-	0.023	-	%	OUT=1V _{P-P} , f=1kHz R _L =600Ω, A _V =0dB

(Note 12) Absolute value.

(Note 13) Full range: T_A=-40°C to +85°C

(Note 14) Only LMR981G have shutdown.

(Note 15) Under the high temperature environment, consider the power dissipation of IC when selecting the output current.

When the terminal short circuits are continuously output, the output current is reduced to climb to the temperature inside IC.

OLMR981G (Unless otherwise specified VDD=+1.8V, VSS=0V)

Parameter	Symbol	Temperature Range	Limit			Unit	Conditions
			Min	Typ	Max		
Turn On Time From Shutdown	t _{ON}	25°C	-	19	-	μs	V _{ICM} = VDD/2
Turn On Voltage High	V _{SHDN_H}	25°C	-	1.32	-	V	-
Turn On Voltage Low	V _{SHDN_L}		-	0.72	-		-

Electrical Characteristics - continued

OLMR981G, LMR931G (Unless otherwise specified VDD=+2.7V, VSS=0V, SHDN=VDD)

Parameter	Symbol	Temperature Range	Limit			Unit	Conditions
			Min	Typ	Max		
Input Offset Voltage (Note 16)	V _{IO}	25°C	-	1	4	mV	VDD=1.8V to 5.0V
		Full Range	-	-	6		
Input Offset Voltage Drift	ΔV _{IO} /ΔT	25°C	-	5.5	-	μV/°C	-
Input Offset Current (Note 16)	I _{IO}	25°C	-	5	30	nA	-
Input Bias Current (Note 16)	I _B	25°C	-	5	35	nA	-
Supply Current (Note 17)	I _{DD}	25°C	-	80	190	μA	A _V =0dB, +IN=1.35V
		Full range	-	-	210		
Shutdown Current (Note 18)	I _{DD_SD}	25°C	-	0.061	1	μA	SHDN=0V
Maximum Output Voltage(High)	V _{OH}	25°C	2.55	2.62	-	V	R _L =600Ω, V _{RL} =VDD/2
			2.65	2.67	-		R _L =2kΩ, V _{RL} =VDD/2
Maximum Output Voltage(Low)	V _{OL}	25°C	-	83	110	mV	R _L =600Ω, V _{RL} =VDD/2
			-	25	40		R _L =2kΩ, V _{RL} =VDD/2
Large Signal Voltage Gain	A _V	25°C	-	98	-	dB	R _L =600Ω, V _{RL} =VDD/2
			92	100	-		R _L =2kΩ, V _{RL} =VDD/2
Input Common-mode Voltage Range	V _{ICM}	25°C	VSS	-	VDD	V	VSS to VDD
		Full range	VSS+0.2	-	VDD-0.2		
Common-mode Rejection Ratio	CMRR	25°C	60	94	-	dB	V _{ICM} =0.5V
Power Supply Rejection Ratio	PSRR	25°C	75	85	-	dB	VDD=1.8V to 5.0V V _{ICM} =0.5V
Output Source Current (Note 19)	I _{SOURCE}	25°C	20	28	-	mA	OUT=0V, Short Current
Output Sink Current (Note 19)	I _{SINK}	25°C	18	28	-	mA	OUT=2.7V Short Current
Slew Rate	SR	25°C	-	0.4	-	V/μs	C _L =25pF
Gain Bandwidth	GBW	25°C	-	1.4	-	MHz	C _L =25pF, A _V =40dB f=100kHz
Unity Gain Frequency	f _T	25°C	-	1.4	-	MHz	C _L =25pF, A _V =40dB
Phase Margin	θ	25°C	-	50	-	deg	C _L =25pF, A _V =40dB
Gain Margin	GM	25°C	-	7	-	dB	C _L =25pF, A _V =40dB
Input Referred Noise Voltage	V _N	25°C	-	6.5	-	μVrms	A _V =40dB, DIN-AUDIO
			-	50	-	nV/√Hz	f=10kHz
Total Harmonic Distortion + Noise	THD+N	25°C	-	0.022	-	%	OUT=1V _{P-P} , f=1kHz R _L =600Ω, A _V =0dB

(Note 16) Absolute value.

(Note 17) Full range: T_A=-40°C to +85°C

(Note 18) Only LMR981G have shutdown.

(Note 19) Under the high temperature environment, consider the power dissipation of IC when selecting the output current.

When the terminal short circuits are continuously output, the output current is reduced to climb to the temperature inside IC.

OLMR981G (Unless otherwise specified VDD=+2.7V, VSS=0V)

Parameter	Symbol	Temperature Range	Limit			Unit	Conditions
			Min	Typ	Max		
Turn On Time From Shutdown	t _{ON}	25°C	-	12.5	-	μs	V _{ICM} = VDD/2
Turn On Voltage High	V _{SHDN_H}	25°C	-	1.63	-	V	-
Turn On Voltage Low	V _{SHDN_L}		-	1.35	-		-

Electrical Characteristics - continued

OLMR981G, LMR931G (Unless otherwise specified VDD=+5.0V, VSS=0V, SHDN=VDD)

Parameter	Symbol	Temperature Range	Limit			Unit	Conditions
			Min	Typ	Max		
Input Offset Voltage (Note 20)	V _{IO}	25°C	-	1	4	mV	VDD=1.8V to 5.0V
		Full Range	-	-	6		
Input Offset Voltage Drift	ΔV _{IO} /ΔT	25°C	-	5.5	-	μV/°C	-
Input Offset Current (Note 20)	I _{IO}	25°C	-	5	30	nA	-
Input Bias Current (Note 20)	I _B	25°C	-	5	35	nA	-
Supply Current (Note 21)	I _{DD}	25°C	-	85	200	μA	A _V =0dB, +IN=2.5V
		Full range	-	-	230		
Shutdown Current (Note 22)	I _{DD_SD}	25°C	-	0.2	1	μA	SHDN=0V
Maximum Output Voltage(High)	V _{OH}	25°C	4.85	4.89	-	V	R _L =600Ω, V _{RL} =VDD/2
			4.94	4.96	-		R _L =2kΩ, V _{RL} =VDD/2
Maximum Output Voltage(Low)	V _{OL}	25°C	-	120	160	mV	R _L =600Ω, V _{RL} =VDD/2
			-	37	65		R _L =2kΩ, V _{RL} =VDD/2
Large Signal Voltage Gain	A _V	25°C	-	101	-	dB	R _L =600Ω, V _{RL} =VDD/2
			94	105	-		R _L =2kΩ, V _{RL} =VDD/2
Input Common-mode Voltage Range	V _{ICM}	25°C	VSS	-	VDD	V	VSS to VDD
		Full range	VSS+0.2	-	VDD-0.2		
Common-mode Rejection Ratio	CMRR	25°C	60	94	-	dB	V _{ICM} =0.5V
Power Supply Rejection Ratio	PSRR	25°C	75	85	-	dB	VDD=1.8V to 5.0V V _{ICM} =0.5V
Output Source Current (Note 23)	I _{SOURCE}	25°C	80	90	-	mA	OUT=0V, Short Current
Output Sink Current (Note 23)	I _{SINK}	25°C	58	80	-	mA	OUT=5V Short Current
Slew Rate	SR	25°C	-	0.42	-	V/μs	C _L =25pF
Gain Bandwidth	GBW	25°C	-	1.5	-	MHz	C _L =25pF, A _V =40dB f=100kHz
Unity Gain Frequency	f _T	25°C	-	1.5	-	MHz	C _L =25pF, A _V =40dB
Phase Margin	θ	25°C	-	50	-	deg	C _L =25pF, A _V =40dB
Gain Margin	GM	25°C	-	7	-	dB	C _L =25pF, A _V =40dB
Input Referred Noise Voltage	V _N	25°C	-	6.5	-	μVrms	A _V =40dB, DIN-AUDIO
			-	50	-	nV/√Hz	f=10kHz
Total Harmonic Distortion + Noise	THD+N	25°C	-	0.022	-	%	OUT=1V _{P-P} , f=1kHz R _L =600Ω, A _V =0dB

(Note 20) Absolute value

(Note 21) Full range: T_A=-40°C to +85°C

(Note 22) Only LMR981G have shutdown.

(Note 23) Under the high temperature environment, consider the power dissipation of IC when selecting the output current.

When the terminal short circuits are continuously output, the output current is reduced to climb to the temperature inside IC.

OLMR981G (Unless otherwise specified VDD=+5.0V, VSS=0V)

Parameter	Symbol	Temperature Range	Limit			Unit	Conditions
			Min	Typ	Max		
Turn On Time From Shutdown	t _{ON}	25°C	-	8.4	-	μs	V _{ICM} = VDD/2
Turn On Voltage High	V _{SHDN_H}	25°C	-	2.98	-	V	-
Turn On Voltage Low	V _{SHDN_L}		-	2.70	-		-

Electrical Characteristics - continued

OLMR982FVM, LMR932xxx (Unless otherwise specified VDD=+1.8V, VSS=0V, SHDN=VDD *LMR982FVM only)

Parameter	Symbol	Temperature Range	Limit			Unit	Conditions
			Min	Typ	Max		
Input Offset Voltage (Note 24)	V _{IO}	25°C	-	1	5.5	mV	VDD=1.8V to 5.0V
		Full Range	-	-	7.5		
Input Offset Voltage Drift	ΔV _{IO} /ΔT	25°C	-	5.5	-	μV/°C	-
Input Offset Current (Note 24)	I _{IO}	25°C	-	5	30	nA	-
Input Bias Current (Note 24)	I _B	25°C	-	5	35	nA	-
Supply Current (Note 25)	I _{DD}	25°C	-	135	290	μA	A _V =0dB, +IN=0.9V
		Full range	-	-	410		
Shutdown Current (Note 26)	I _{DD_SD}	25°C	-	0.15	1	μA	SHDN=0V
Maximum Output Voltage(High)	V _{OH}	25°C	1.65	1.72	-	V	R _L =600Ω, V _{RL} =VDD/2
			1.75	1.77	-		R _L =2kΩ, V _{RL} =VDD/2
Maximum Output Voltage(Low)	V _{OL}	25°C	-	77	105	mV	R _L =600Ω, V _{RL} =VDD/2
			-	24	35		R _L =2kΩ, V _{RL} =VDD/2
Large Signal Voltage Gain	A _V	25°C	-	94	-	dB	R _L =600Ω, V _{RL} =VDD/2
			80	100	-		R _L =2kΩ, V _{RL} =VDD/2
Input Common-mode Voltage Range	V _{ICM}	25°C	VSS	-	VDD	V	VSS to VDD
		Full range	VSS+0.2	-	VDD-0.2		
Common-mode Rejection Ratio	CMRR	25°C	60	94	-	dB	V _{ICM} =0.5V
Power Supply Rejection Ratio	PSRR	25°C	75	85	-	dB	VDD=1.8V to 5.0V V _{ICM} =0.5V
Output Source Current (Note 27)	I _{SOURCE}	25°C	4	8	-	mA	OUT=0V, Short Current
Output Sink Current (Note 27)	I _{SINK}	25°C	7	9	-	mA	OUT=1.8V Short Current
Slew Rate	SR	25°C	-	0.35	-	V/μs	C _L =25pF
Gain Bandwidth	GBW	25°C	-	1.4	-	MHz	C _L =25pF, A _V =40dB f=100kHz
Unity Gain Frequency	f _T	25°C	-	1.4	-	MHz	C _L =25pF, A _V =40dB
Phase Margin	θ	25°C	-	50	-	deg	C _L =25pF, A _V =40dB
Gain Margin	GM	25°C	-	7	-	dB	C _L =25pF, A _V =40dB
Input Referred Noise Voltage	V _N	25°C	-	6.5	-	μVrms	A _V =40dB, DIN-AUDIO
			-	50	-	nV/√Hz	f=10kHz
Total Harmonic Distortion + Noise	THD+N	25°C	-	0.023	-	%	OUT=1V _{P-P} , f=1kHz R _L =600Ω, A _V =0dB
Channel Separation	CS	25°C	-	110	-	dB	A _V =40dB, OUT=1Vrms

(Note 24) Absolute value.

(Note 25) Full range: T_A=-40°C to +85°C

(Note 26) Only LMR982FVM have shutdown.

(Note 27) Under the high temperature environment, consider the power dissipation of IC when selecting the output current.

When the terminal short circuits are continuously output, the output current is reduced to climb to the temperature inside IC.

OLMR982FVM (Unless otherwise specified VDD=+1.8V, VSS=0V)

Parameter	Symbol	Temperature Range	Limit			Unit	Conditions
			Min	Typ	Max		
Turn On Time From Shutdown	t _{ON}	25°C	-	19	-	μs	V _{ICM} = VDD/2
Turn On Voltage High	V _{SHDN_H}	25°C	-	1.32	-	V	-
Turn On Voltage Low	V _{SHDN_L}		-	0.72	-		-

Electrical Characteristics - continued

OLMR982FVM, LMR932xxx (Unless otherwise specified VDD=+2.7V, VSS=0V, SHDN=VDD)

Parameter	Symbol	Temperature Range	Limit			Unit	Conditions
			Min	Typ	Max		
Input Offset Voltage (Note 28)	V _{IO}	25°C	-	1	5.5	mV	VDD=1.8V to 5.0V
		Full Range	-	-	7.5		
Input Offset Voltage Drift	ΔV _{IO} /ΔT	25°C	-	5.5	-	μV/°C	-
Input Offset Current (Note 28)	I _{IO}	25°C	-	5	30	nA	-
Input Bias Current (Note 28)	I _B	25°C	-	5	35	nA	-
Supply Current (Note 29)	I _{DD}	25°C	-	135	300	μA	A _V =0dB, +IN=1.35V
		Full range	-	-	420		
Shutdown Current (Note 30)	I _{DD_SD}	25°C	-	0.061	1	μA	SHDN=0V
Maximum Output Voltage(High)	V _{OH}	25°C	2.55	2.62	-	V	R _L =600Ω, V _{RL} =VDD/2
			2.65	2.67	-		R _L =2kΩ, V _{RL} =VDD/2
Maximum Output Voltage(Low)	V _{OL}	25°C	-	83	110	mV	R _L =600Ω, V _{RL} =VDD/2
			-	25	40		R _L =2kΩ, V _{RL} =VDD/2
Large Signal Voltage Gain	A _V	25°C	-	98	-	dB	R _L =600Ω, V _{RL} =VDD/2
			92	100	-		R _L =2kΩ, V _{RL} =VDD/2
Input Common-mode Voltage Range	V _{ICM}	25°C	VSS	-	VDD	V	VSS to VDD
		Full range	VSS+0.2	-	VDD-0.2		
Common-mode Rejection Ratio	CMRR	25°C	60	94	-	dB	V _{ICM} =0.5V
Power Supply Rejection Ratio	PSRR	25°C	75	85	-	dB	VDD=1.8V to 5.0V V _{ICM} =0.5V
Output Source Current (Note 31)	I _{SOURCE}	25°C	20	28	-	mA	OUT=0V, Short Current
Output Sink Current (Note 31)	I _{SINK}	25°C	18	28	-	mA	OUT=2.7V Short Current
Slew Rate	SR	25°C	-	0.4	-	V/μs	C _L =25pF
Gain Bandwidth	GBW	25°C	-	1.4	-	MHz	C _L =25pF, A _V =40dB f=100kHz
Unity Gain Frequency	f _T	25°C	-	1.4	-	MHz	C _L =25pF, A _V =40dB
Phase Margin	θ	25°C	-	50	-	deg	C _L =25pF, A _V =40dB
Gain Margin	GM	25°C	-	7	-	dB	C _L =25pF, A _V =40dB
Input Referred Noise Voltage	V _N	25°C	-	6.5	-	μVrms	A _V =40dB, DIN-AUDIO
			-	50	-	nV/√Hz	f=10kHz
Total Harmonic Distortion + Noise	THD+N	25°C	-	0.022	-	%	OUT=1V _{P-P} , f=1kHz R _L =600Ω, A _V =0dB
Channel Separation	CS	25°C	-	110	-	dB	A _V =40dB, OUT=1Vrms

(Note 28) Absolute value.

(Note 29) Full range: T_A=-40°C to +85°C

(Note 30) Only LMR982FVM have shutdown.

(Note 31) Under the high temperature environment, consider the power dissipation of IC when selecting the output current.

When the terminal short circuits are continuously output, the output current is reduced to climb to the temperature inside IC.

OLMR982FVM (Unless otherwise specified VDD=+2.7V, VSS=0V)

Parameter	Symbol	Temperature Range	Limit			Unit	Conditions
			Min	Typ	Max		
Turn On Time From Shutdown	t _{ON}	25°C	-	12.5	-	μs	V _{ICM} = VDD/2
Turn On Voltage High	V _{SHDN_H}	25°C	-	1.63	-	V	-
Turn On Voltage Low	V _{SHDN_L}		-	1.35	-		-

Electrical Characteristics - continued

OLMR982FVM, LMR932xxx (Unless otherwise specified VDD=+5.0V, VSS=0V, SHDN=VDD)

Parameter	Symbol	Temperature Range	Limit			Unit	Conditions
			Min	Typ	Max		
Input Offset Voltage (Note 32)	V _{IO}	25°C	-	1	5.5	mV	VDD=1.8V to 5.0V
		Full Range	-	-	7.5		
Input Offset Voltage Drift	ΔV _{IO} /ΔT	25°C	-	5.5	-	μV/°C	-
Input Offset Current (Note 32)	I _{IO}	25°C	-	5	30	nA	-
Input Bias Current (Note 32)	I _B	25°C	-	5	35	nA	-
Supply Current (Note 33)	I _{DD}	25°C	-	140	300	μA	A _V =0dB, +IN=2.5V
		Full range	-	-	460		
Shutdown Current (Note 34)	I _{DD_SD}	25°C	-	0.2	1	μA	SHDN=0V
Maximum Output Voltage(High)	V _{OH}	25°C	4.85	4.89	-	V	R _L =600Ω, V _{RL} =VDD/2
			4.94	4.96	-		R _L =2kΩ, V _{RL} =VDD/2
Maximum Output Voltage(Low)	V _{OL}	25°C	-	120	160	mV	R _L =600Ω, V _{RL} =VDD/2
			-	37	65		R _L =2kΩ, V _{RL} =VDD/2
Large Signal Voltage Gain	A _V	25°C	-	101	-	dB	R _L =600Ω, V _{RL} =VDD/2
			94	105	-		R _L =2kΩ, V _{RL} =VDD/2
Input Common-mode Voltage Range	V _{ICM}	25°C	VSS	-	VDD	V	VSS to VDD
		Full range	VSS+0.2	-	VDD-0.2		
Common-mode Rejection Ratio	CMRR	25°C	60	94	-	dB	V _{ICM} =0.5V
Power Supply Rejection Ratio	PSRR	25°C	75	85	-	dB	VDD=1.8V to 5.0V V _{ICM} =0.5V
Output Source Current (Note 35)	I _{SOURCE}	25°C	80	90	-	mA	OUT=0V, Short Current
Output Sink Current (Note 35)	I _{SINK}	25°C	58	80	-	mA	OUT=5V Short Current
Slew Rate	SR	25°C	-	0.42	-	V/μs	C _L =25pF
Gain Bandwidth	GBW	25°C	-	1.5	-	MHz	C _L =25pF, A _V =40dB f=100kHz
Unity Gain Frequency	f _T	25°C	-	1.5	-	MHz	C _L =25pF, A _V =40dB
Phase Margin	θ	25°C	-	50	-	deg	C _L =25pF, A _V =40dB
Gain Margin	GM	25°C	-	7	-	dB	C _L =25pF, A _V =40dB
Input Referred Noise Voltage	V _N	25°C	-	6.5	-	μVrms	A _V =40dB, DIN-AUDIO
			-	50	-	nV/√Hz	f=10kHz
Total Harmonic Distortion + Noise	THD+N	25°C	-	0.022	-	%	OUT=1V _{P-P} , f=1kHz R _L =600Ω, A _V =0dB
Channel Separation	CS	25°C	-	110	-	dB	A _V =40dB, OUT=1Vrms

(Note 32) Absolute value

(Note 33) Full range: T_A=-40°C to +85°C

(Note 34) Only LMR982FVM have shutdown.

(Note 35) Under the high temperature environment, consider the power dissipation of IC when selecting the output current.

When the terminal short circuits are continuously output, the output current is reduced to climb to the temperature inside IC.

OLMR982FVM (Unless otherwise specified VDD=+5.0V, VSS=0V)

Parameter	Symbol	Temperature Range	Limit			Unit	Conditions
			Min	Typ	Max		
Turn On Time From Shutdown	t _{ON}	25°C	-	8.4	-	μs	V _{ICM} = VDD/2
Turn On Voltage High	V _{SHDN_H}	25°C	-	2.98	-	V	-
Turn On Voltage Low	V _{SHDN_L}		-	2.70	-		-

Electrical Characteristics - continued

OLMR934xxx (Unless otherwise specified VDD=+1.8V, VSS=0V)

Parameter	Symbol	Temperature Range	Limits			Unit	Condition
			Min	Typ	Max		
Input Offset Voltage ^(Note 36)	V _{IO}	25°C	-	1	5.5	mV	VDD=1.8V to 5.0V
		Full Range	-	-	7.5		
Input Offset Voltage Drift	ΔV _{IO} /ΔT	25°C	-	5.5	-	μV/°C	-
Input Offset Current ^(Note 36)	I _{IO}	25°C	-	5	30	nA	-
Input Bias Current ^(Note 36)	I _B	25°C	-	5	35	nA	-
Supply Current ^(Note 37)	I _{DD}	25°C	-	280	550	μA	A _V =0dB, +IN=0.9V
		Full range	-	-	820		
Maximum Output Voltage(High)	V _{OH}	25°C	1.65	1.72	-	V	R _L =600Ω, V _{RL} =VDD/2
			1.75	1.77	-		R _L =2kΩ, V _{RL} =VDD/2
Maximum Output Voltage(Low)	V _{OL}	25°C	-	77	105	mV	R _L =600Ω, V _{RL} =VDD/2
			-	24	35		R _L =2kΩ, V _{RL} =VDD/2
Large Signal Voltage Gain	A _V	25°C	-	96	-	dB	R _L =600Ω, V _{RL} =VDD/2
			80	100	-		R _L =2kΩ, V _{RL} =VDD/2
Input Common-mode Voltage Range	V _{ICM}	25°C	VSS	-	VDD	V	VSS to VDD
		Full range	VSS+0.2	-	VDD-0.2		
Common-mode Rejection Ratio	CMRR	25°C	60	94	-	dB	V _{ICM} =0.5V
Power Supply Rejection Ratio	PSRR	25°C	75	85	-	dB	VDD=1.8V to 5.0V V _{ICM} =0.5V
Output Source Current ^(Note 38)	I _{SOURCE}	25°C	4	8	-	mA	OUT=0V, Short Current
Output Sink Current ^(Note 38)	I _{SINK}	25°C	7	9	-	mA	OUT=1.8V Short Current
Slew Rate	SR	25°C	-	0.35	-	V/μs	C _L =25pF
Gain Bandwidth	GBW	25°C	-	1.4	-	MHz	C _L =25pF, A _V =40dB f=100kHz
Unity Gain Frequency	f _T	25°C	-	1.4	-	MHz	C _L =25pF, A _V =40dB
Phase Margin	θ	25°C	-	50	-	deg	C _L =25pF, A _V =40dB
Gain Margin	GM	25°C	-	7	-	dB	C _L =25pF, A _V =40dB
Input Referred Noise Voltage	V _N	25°C	-	6.5	-	μVrms	A _V =40dB, DIN-AUDIO
			-	50	-	nV/√Hz	f=10kHz
Total Harmonic Distortion + Noise	THD+N	25°C	-	0.023	-	%	OUT=1V _{P-P} , f=1kHz R _L =600Ω, A _V =0dB
Channel Separation	CS	25°C	-	110	-	dB	A _V =40dB, OUT=1Vrms

(Note 36) Absolute value.

(Note 37) Full range: T_A=-40°C to +85°C

(Note 38) Under the high temperature environment, consider the power dissipation of IC when selecting the output current.

When the terminal short circuits are continuously output, the output current is reduced to climb to the temperature inside IC.

Electrical Characteristics - continued

OLMR934xxx (Unless otherwise specified VDD=+2.7V, VSS=0V)

Parameter	Symbol	Temperature Range	Limit			Unit	Conditions
			Min	Typ	Max		
Input Offset Voltage ^(Note 39)	V _{IO}	25°C	-	1	5.5	mV	VDD=1.8V to 5.0V
		Full Range	-	-	7.5		
Input Offset Voltage Drift	ΔV _{IO} /ΔT	25°C	-	5.5	-	μV/°C	-
Input Offset Current ^(Note 39)	I _{IO}	25°C	-	5	30	nA	-
Input Bias Current ^(Note 39)	I _B	25°C	-	5	35	nA	-
Supply Current ^(Note 40)	I _{DD}	25°C	-	250	600	μA	A _V =0dB, +IN=1.35V
		Full range	-	-	840		
Maximum Output Voltage(High)	V _{OH}	25°C	2.55	2.62	-	V	R _L =600Ω, V _{RL} =VDD/2
			2.65	2.67	-		R _L =2kΩ, V _{RL} =VDD/2
Maximum Output Voltage(Low)	V _{OL}	25°C	-	83	110	mV	R _L =600Ω, V _{RL} =VDD/2
			-	25	40		R _L =2kΩ, V _{RL} =VDD/2
Large Signal Voltage Gain	A _V	25°C	-	98	-	dB	R _L =600Ω, V _{RL} =VDD/2
			92	100	-		R _L =2kΩ, V _{RL} =VDD/2
Input Common-mode Voltage Range	V _{ICM}	25°C	VSS	-	VDD	V	VSS to VDD
		Full range	VSS+0.2	-	VDD-0.2		
Common-mode Rejection Ratio	CMRR	25°C	60	94	-	dB	V _{ICM} =0.5V
Power Supply Rejection Ratio	PSRR	25°C	75	85	-	dB	VDD=1.8V to 5.0V V _{ICM} =0.5V
Output Source Current ^(Note 41)	I _{SOURCE}	25°C	20	28	-	mA	OUT=0V, Short Current
Output Sink Current ^(Note 41)	I _{SINK}	25°C	18	28	-	mA	OUT=2.7V Short Current
Slew Rate	SR	25°C	-	0.4	-	V/μs	C _L =25pF
Gain Bandwidth	GBW	25°C	-	1.4	-	MHz	C _L =25pF, A _V =40dB f=100kHz
Unity Gain Frequency	f _T	25°C	-	1.4	-	MHz	C _L =25pF, A _V =40dB
Phase Margin	θ	25°C	-	50	-	deg	C _L =25pF, A _V =40dB
Gain Margin	GM	25°C	-	7	-	dB	C _L =25pF, A _V =40dB
Input Referred Noise Voltage	V _N	25°C	-	6.5	-	μVrms	A _V =40dB, DIN-AUDIO
			-	50	-	nV/√Hz	f=10kHz
Total Harmonic Distortion + Noise	THD+N	25°C	-	0.022	-	%	OUT=1V _{P-P} , f=1kHz R _L =600Ω, A _V =0dB
Channel Separation	CS	25°C	-	110	-	dB	A _V =40dB, OUT=1Vrms

(Note 39) Absolute value.

(Note 40) Full range: T_A=-40°C to +85°C

(Note 41) Under the high temperature environment, consider the power dissipation of IC when selecting the output current.

When the terminal short circuits are continuously output, the output current is reduced to climb to the temperature inside IC.

Electrical Characteristics - continued

OLMR934xxx (Unless otherwise specified VDD=+5.0V, VSS=0V)

Parameter	Symbol	Temperature Range	Limit			Unit	Conditions
			Min	Typ	Max		
Input Offset Voltage (Note 42)	V _{IO}	25°C	-	1	5.5	mV	VDD=1.8V to 5.0V
		Full Range	-	-	7.5		
Input Offset Voltage Drift	ΔV _{IO} /ΔT	25°C	-	5.5	-	μV/°C	-
Input Offset Current (Note 42)	I _{IO}	25°C	-	5	30	nA	-
Input Bias Current (Note 42)	I _B	25°C	-	5	35	nA	-
Supply Current (Note 43)	I _{DD}	25°C	-	290	600	μA	A _V =0dB, +IN=2.5V
		Full range	-	-	920		
Maximum Output Voltage(High)	V _{OH}	25°C	4.85	4.89	-	V	R _L =600Ω, V _{RL} =VDD/2
			4.94	4.96	-		R _L =2kΩ, V _{RL} =VDD/2
Maximum Output Voltage(Low)	V _{OL}	25°C	-	120	160	mV	R _L =600Ω, V _{RL} =VDD/2
			-	37	65		R _L =2kΩ, V _{RL} =VDD/2
Large Signal Voltage Gain	A _V	25°C	-	101	-	dB	R _L =600Ω, V _{RL} =VDD/2
			94	105	-		R _L =2kΩ, V _{RL} =VDD/2
Input Common-mode Voltage Range	V _{ICM}	25°C	VSS	-	VDD	V	VSS to VDD
		Full range	VSS+0.2	-	VDD-0.2		
Common-mode Rejection Ratio	CMRR	25°C	60	94	-	dB	V _{ICM} =0.5V
Power Supply Rejection Ratio	PSRR	25°C	75	85	-	dB	VDD=1.8V to 5.0V V _{ICM} =0.5V
Output Source Current (Note 44)	I _{SOURCE}	25°C	80	90	-	mA	OUT=0V, Short Current
Output Sink Current (Note 44)	I _{SINK}	25°C	58	80	-	mA	OUT=5V Short Current
Slew Rate	SR	25°C	-	0.42	-	V/μs	C _L =25pF
Gain Bandwidth	GBW	25°C	-	1.5	-	MHz	C _L =25pF, A _V =40dB f=100kHz
Unity Gain Frequency	f _T	25°C	-	1.5	-	MHz	C _L =25pF, A _V =40dB
Phase Margin	θ	25°C	-	50	-	deg	C _L =25pF, A _V =40dB
Gain Margin	GM	25°C	-	7	-	dB	C _L =25pF, A _V =40dB
Input Referred Noise Voltage	V _N	25°C	-	6.5	-	μVrms	A _V =40dB, DIN-AUDIO
			-	50	-	nV/√Hz	f=10kHz
Total Harmonic Distortion + Noise	THD+N	25°C	-	0.022	-	%	OUT=1V _{P-P} , f=1kHz R _L =600Ω, A _V =0dB
Channel Separation	CS	25°C	-	110	-	dB	A _V =40dB, OUT=1Vrms

(Note 42) Absolute value

(Note 43) Full range: T_A=-40°C to +85°C

(Note 44) Under the high temperature environment, consider the power dissipation of IC when selecting the output current.

When the terminal short circuits are continuously output, the output current is reduced to climb to the temperature inside IC.

Description of Electrical Characteristics

Described below are descriptions of the relevant electrical terms used in this datasheet. Items and symbols used are also shown. Note that item name and symbol and their meaning may differ from those on another manufacturer's document or general document.

1. Absolute maximum ratings

Absolute maximum rating items indicate the condition which must not be exceeded. Application of voltage in excess of absolute maximum rating or use out of absolute maximum rated temperature environment may cause deterioration of characteristics.

- (1) Supply Voltage (VDD/VSS)
Indicates the maximum voltage that can be applied between the positive power supply terminal and negative power supply terminal without deterioration or destruction of characteristics of internal circuit.
- (2) Differential Input Voltage (V_{ID})
Indicates the maximum voltage that can be applied between non-inverting and inverting terminals without damaging the IC.
- (3) Input Common-mode Voltage Range (V_{ICM})
Indicates the maximum voltage that can be applied to the non-inverting and inverting terminals without deterioration or destruction of electrical characteristics. Input common-mode voltage range of the maximum ratings does not assure normal operation of IC. For normal operation, use the IC within the input common-mode voltage range characteristics.
- (4) Power dissipation (P_D)
Indicates the power that can be consumed by the IC when mounted on a specific board at the ambient temperature 25°C (normal temperature). As for package product, P_D is determined by the temperature that can be permitted by the IC in the package (maximum junction temperature) and the thermal resistance of the package.

2. Electrical characteristics

- (1) Input Offset Voltage (V_{IO})
Indicates the voltage difference between non-inverting terminal and inverting terminals. It can be translated into the input voltage difference required for setting the output voltage at 0 V.
- (2) Input Offset Voltage Drift ($\Delta V_{IO} / \Delta T$)
Denotes the ratio of the input offset voltage fluctuation to the ambient temperature fluctuation.
- (3) Input Offset Current (I_{IO})
Indicates the difference of input bias current between the non-inverting and inverting terminals.
- (4) Input Bias Current (I_B)
Indicates the current that flows into or out of the input terminal. It is defined by the average of input bias currents at the non-inverting and inverting terminals.
- (5) Supply Current (I_{DD})
Indicates the current that flows within the IC under specified no-load conditions.
- (6) Maximum Output Voltage (High) / Maximum Output Voltage (Low) (V_{OH}/V_{OL})
Indicates the voltage range of the output under specified load condition. It is typically divided into maximum output voltage High and low. Maximum output voltage high indicates the upper limit of output voltage. Maximum output voltage low indicates the lower limit.
- (7) Large Signal Voltage Gain (A_V)
Indicates the amplifying rate (gain) of output voltage against the voltage difference between non-inverting terminal and inverting terminal. It is normally the amplifying rate (gain) with reference to DC voltage.
 $A_v = (\text{Output voltage}) / (\text{Differential Input voltage})$
- (8) Input Common-mode Voltage Range (V_{ICM})
Indicates the input voltage range where IC normally operates.
- (9) Common-mode Rejection Ratio (CMRR)
Indicates the ratio of fluctuation of input offset voltage when the input common mode voltage is changed. It is normally the fluctuation of DC.
 $CMRR = (\text{Change of Input common-mode voltage}) / (\text{Input offset fluctuation})$
- (10) Power Supply Rejection Ratio (PSRR)
Indicates the ratio of fluctuation of input offset voltage when supply voltage is changed.
It is normally the fluctuation of DC.
 $PSRR = (\text{Change of power supply voltage}) / (\text{Input offset fluctuation})$
- (11) Output Source Current / Output Sink Current (I_{source} / I_{sink})
The maximum current that can be output from the IC under specific output conditions. The output source current indicates the current flowing out from the IC, and the output sink current indicates the current flowing into the IC.
- (12) Channel Separation (CS)
Indicates the fluctuation in the output voltage of the driven channel with reference to the change of output voltage of the channel which is not driven.
- (13) Slew Rate (SR)
Indicates the ratio of the change in output voltage with time when a step input signal is applied.
- (14) Gain Bandwidth (GBW)
The product of the open-loop voltage gain and the frequency at which the voltage gain decreases 6dB/octave.
- (15) Unity Gain Frequency (f_T)
Indicates a frequency where the voltage gain of operational amplifier is 1.
- (16) Phase Margin (θ)
Indicates the margin of phase from 180 degree phase lag at unity gain frequency.

- (17) Gain Margin (GM)
Indicates the difference between 0dB and the gain where operational amplifier has 180 degree phase delay.
- (18) Total Harmonic Distortion+Noise (THD+N)
Indicates the fluctuation of input offset voltage or that of output voltage with reference to the change of output voltage of driven channel.
- (19) Input Referred Noise Voltage (V_N)
Indicates a noise voltage generated inside the operational amplifier equivalent by ideal voltage source connected in series with input terminal.
- (20) Turn on Time from Shutdown (t_{ON})
Indicates the time from applying the voltage to shutdown terminal until the IC is active.
- (21) Turn on Voltage / Turn off Voltage (V_{SHDN_H} / V_{SHDN_L})
The IC is active if the shutdown terminal is applied more than Turn On Voltage (V_{SHDN_H}).
The IC is shutdown if the shutdown terminal is applied less than Turn Off Voltage (V_{SHDN_L}).

Typical Performance Curves
 OLMR981G, LMR931G

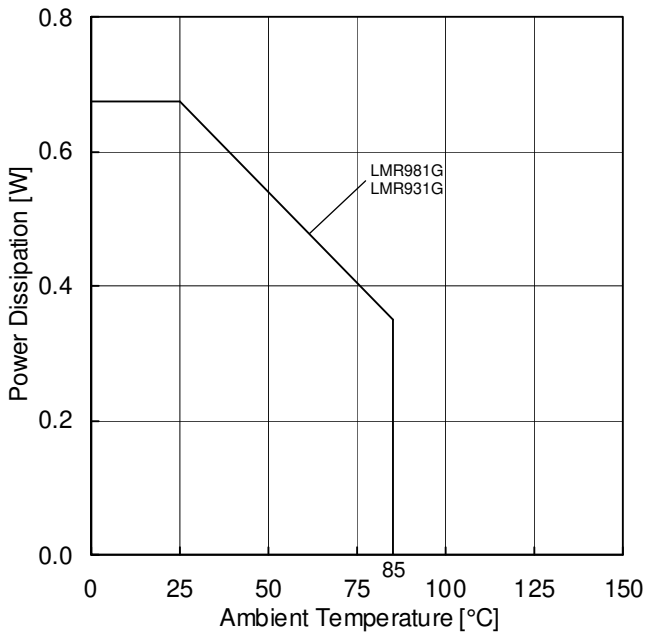

Figure 2.
 Power Dissipation vs Ambient Temperature
 (Derating Curve)

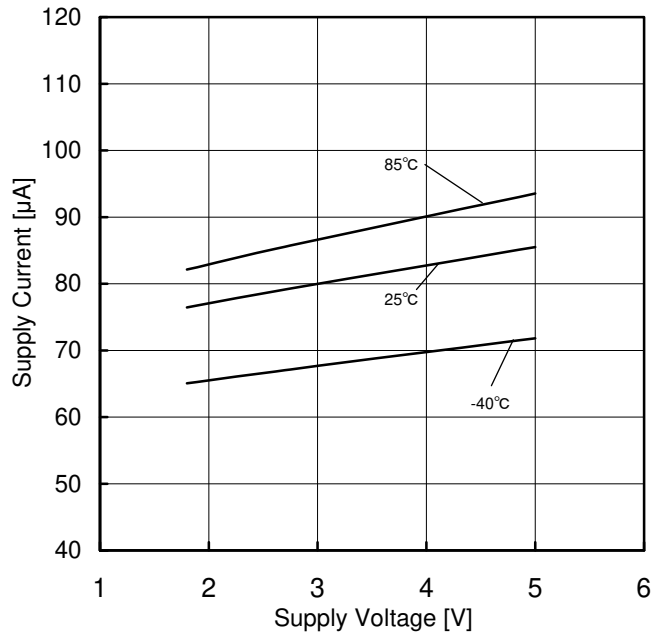

Figure 3.
 Supply Current vs Supply Voltage

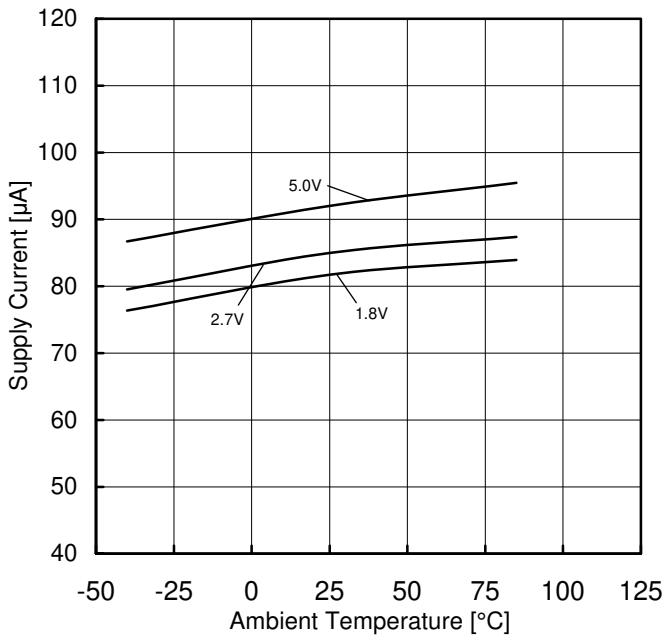

Figure 4.
 Supply Current vs Ambient Temperature

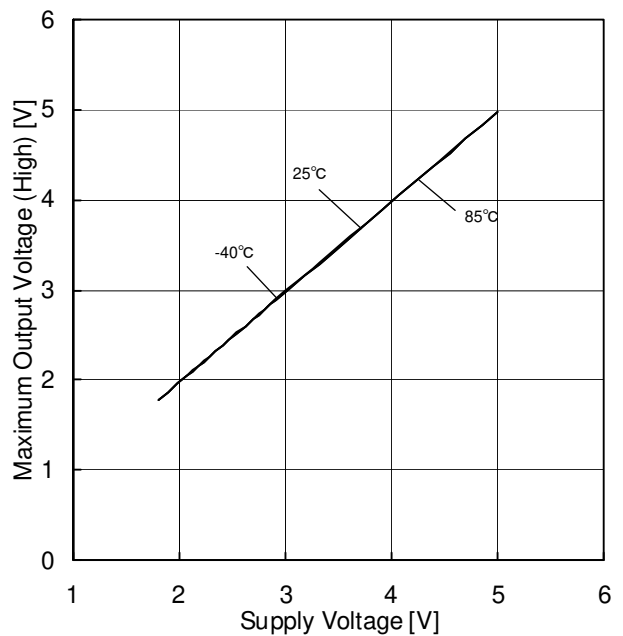

Figure 5.
 Maximum Output Voltage (High) vs Supply Voltage
 (R_L=2kΩ)

(Note) The data above is measurement value of typical sample, it is not guaranteed.

Typical Performance Curves (Reference data) – continued
OLMR981G, LMR931G

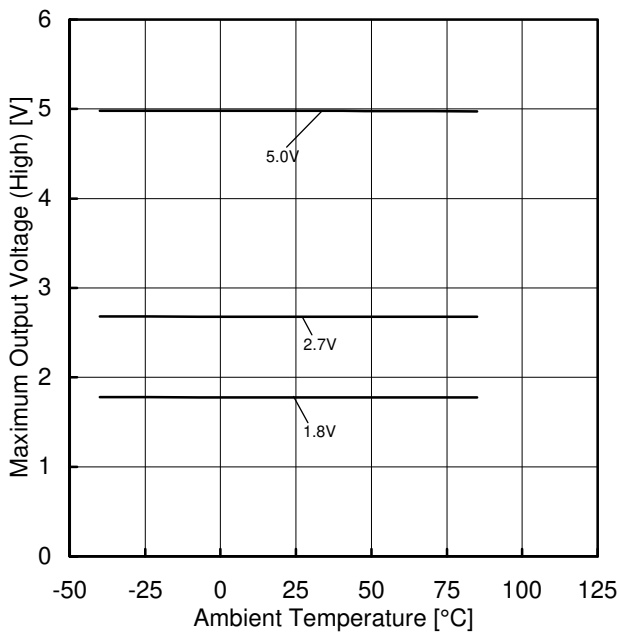

Figure 6.
Maximum Output Voltage (High) vs Ambient Temperature
($R_L=2k\Omega$)

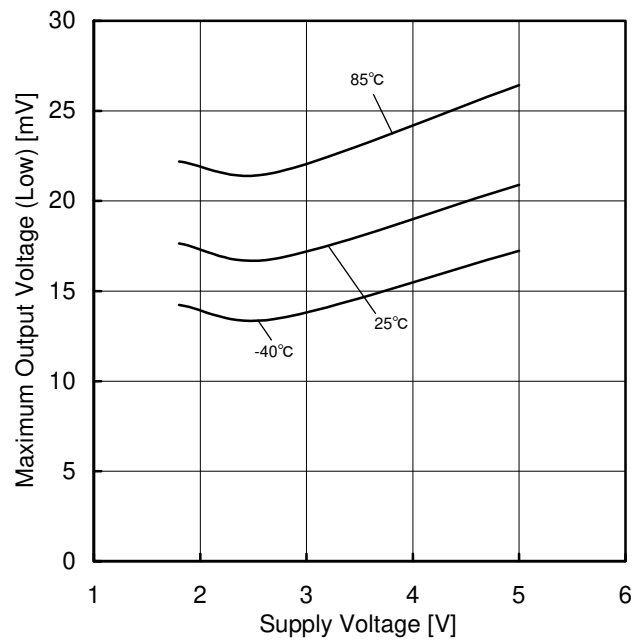

Figure 7.
Maximum Output Voltage (Low) vs Supply Voltage
($R_L=2k\Omega$)

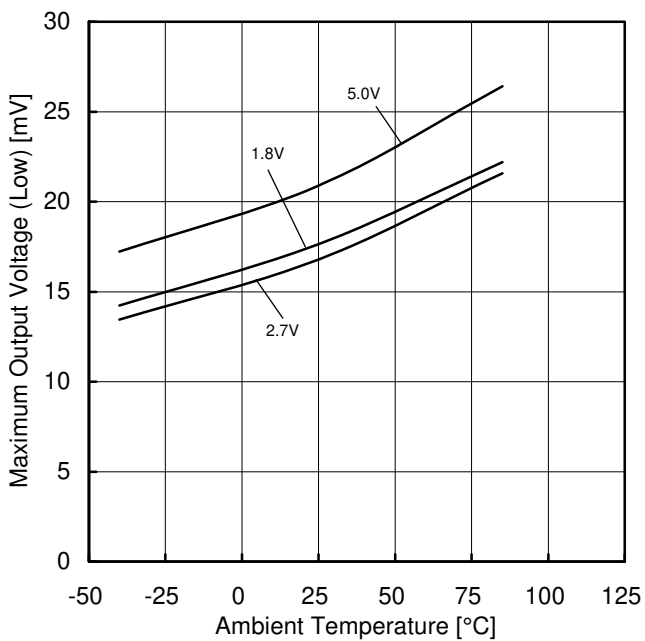

Figure 8.
Maximum Output Voltage (Low) vs Ambient Temperature
($R_L=2k\Omega$)

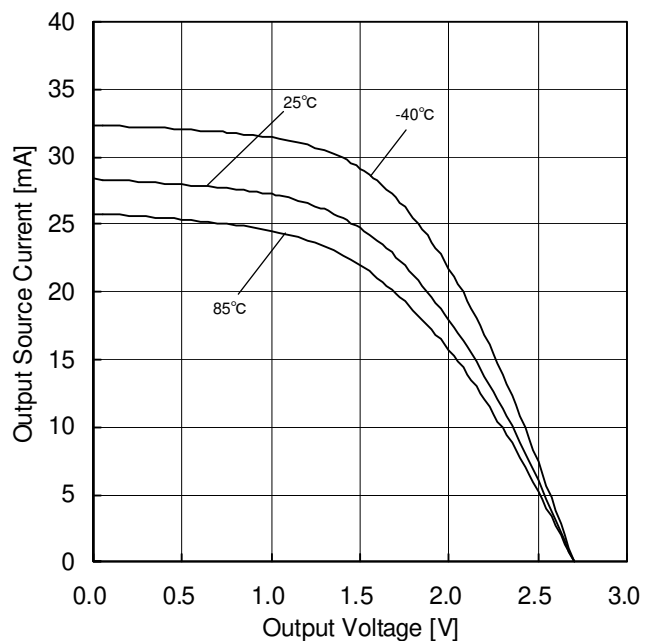

Figure 9.
Output Source Current vs Output Voltage
(VDD=2.7V)

(Note)The data above is measurement value of typical sample, it is not guaranteed.

Typical Performance Curves (Reference data) – continued
OLMR981G, LMR931G

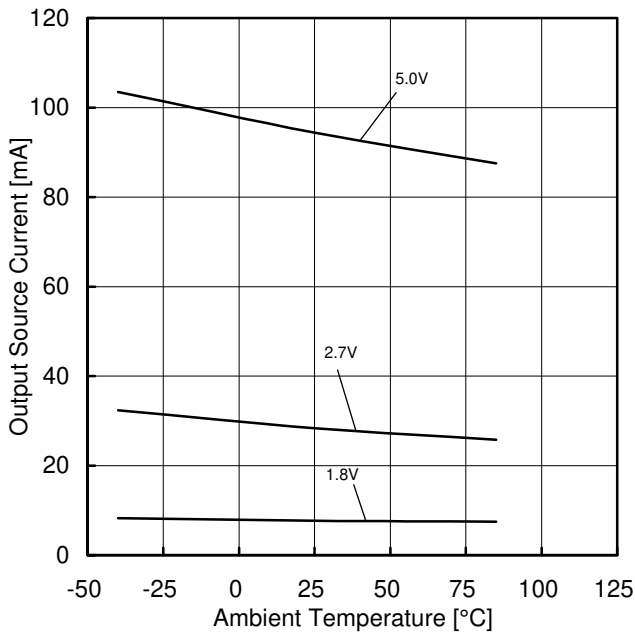

Figure 10.
Output Source Current vs Ambient Temperature
(OUT=VSS)

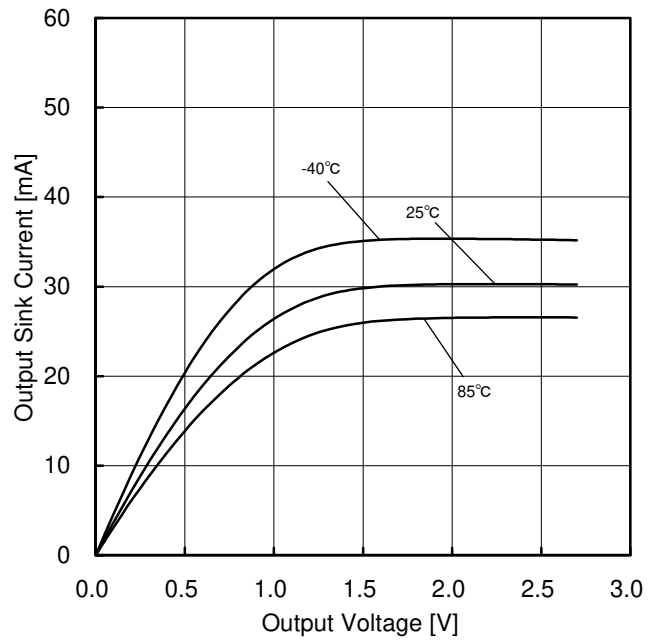

Figure 11.
Output Sink Current vs Output Voltage
(VDD=2.7V)

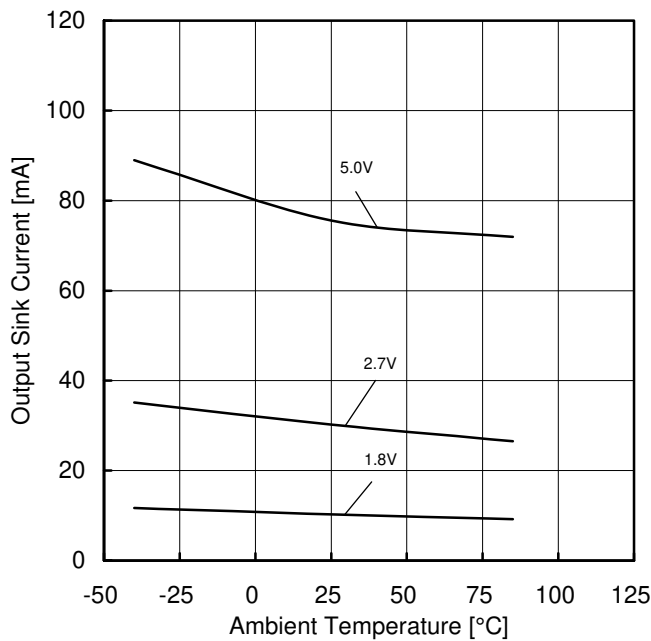

Figure 12.
Output Sink Current vs Ambient Temperature
(OUT=VDD)

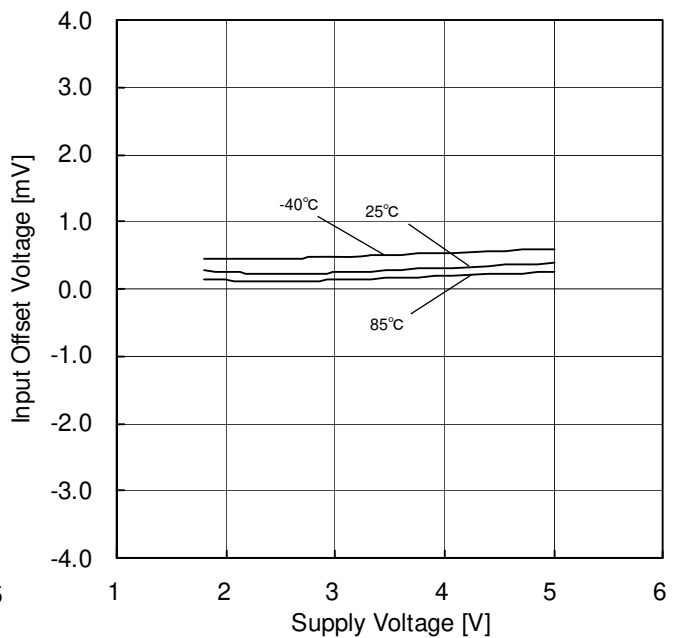

Figure 13.
Input Offset Voltage vs Supply Voltage

(Note)The data above is measurement value of typical sample, it is not guaranteed.

Typical Performance Curves (Reference data) - continued
OLMR981G, LMR931G

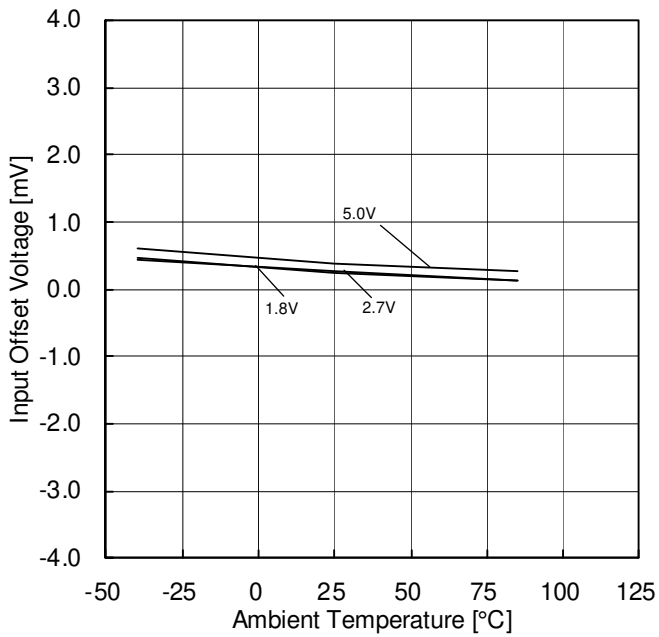

Figure 14.
Input Offset Voltage vs Ambient Temperature

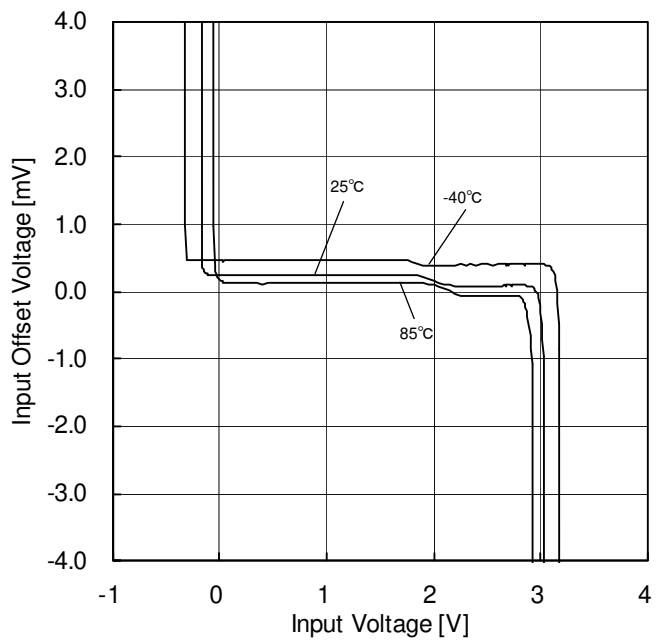

Figure 15.
Input Offset Voltage vs Input Voltage
(VDD=2.7V)

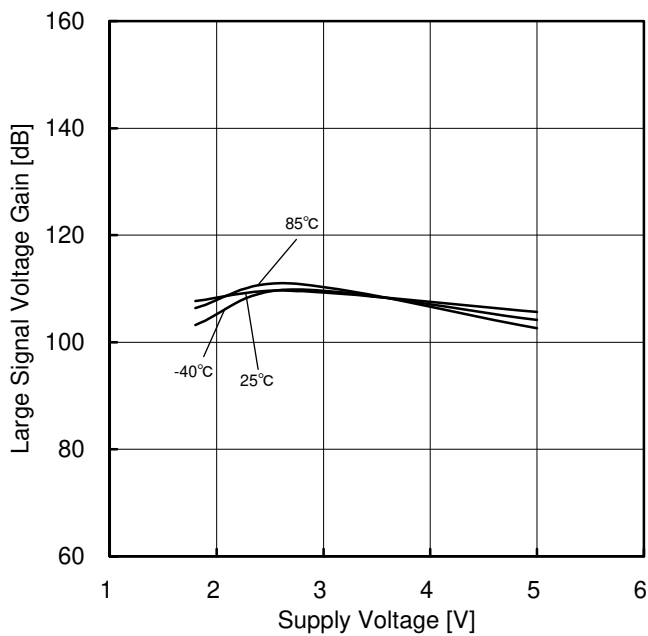

Figure 16.
Large Signal Voltage Gain vs Supply Voltage

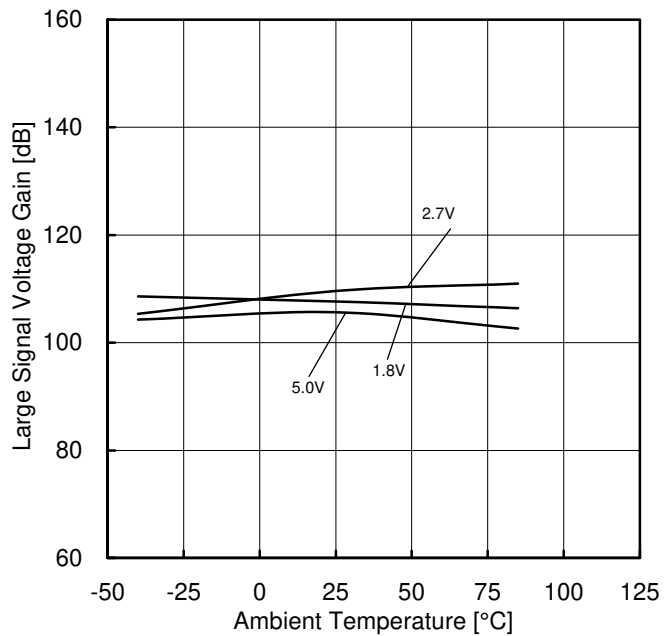

Figure 17.
Large Signal Voltage Gain vs Ambient Temperature

(Note)The data above is measurement value of typical sample, it is not guaranteed.

Typical Performance Curves (Reference data) - continued
OLMR981G, LMR931G

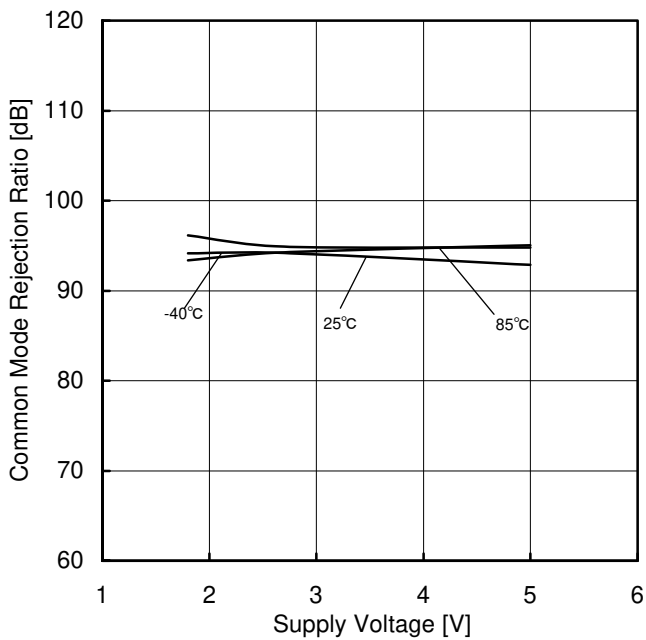

Figure 18.
Common Mode Rejection Ratio vs Supply Voltage
(VDD=2.7V)

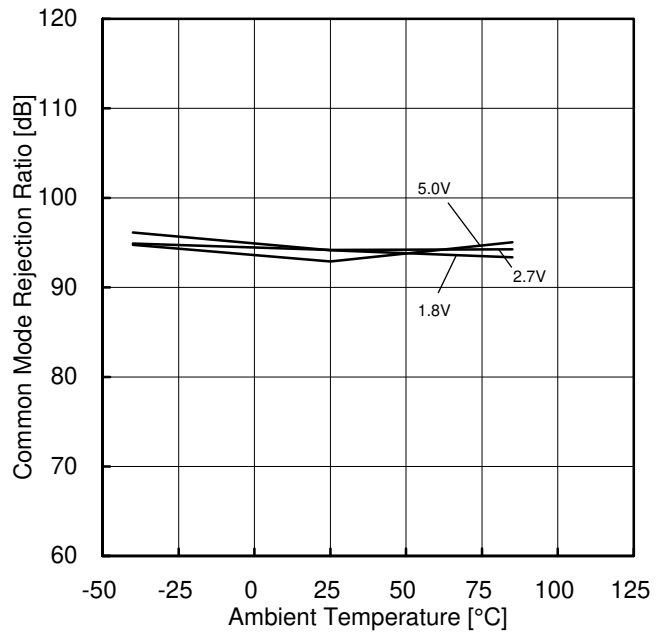

Figure 19.
Common Mode Rejection Ratio vs Ambient Temperature

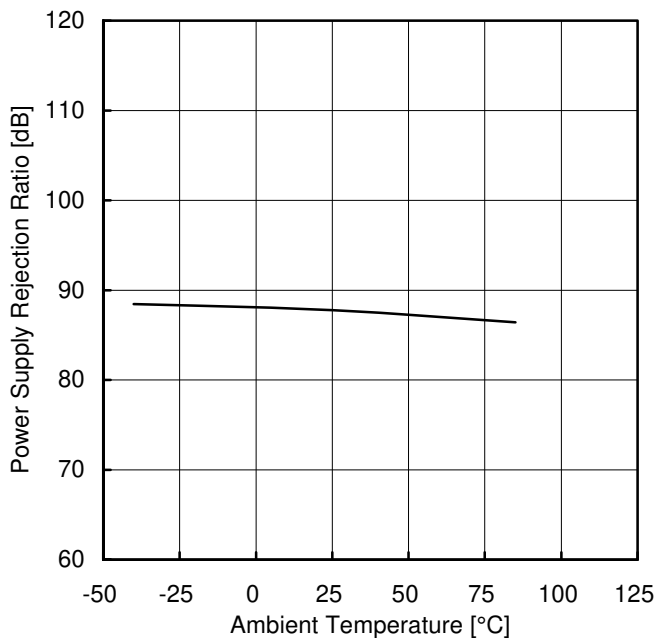

Figure 20.
Power Supply Rejection Ratio vs Ambient Temperature
(VDD=1.8V to 5.0V)

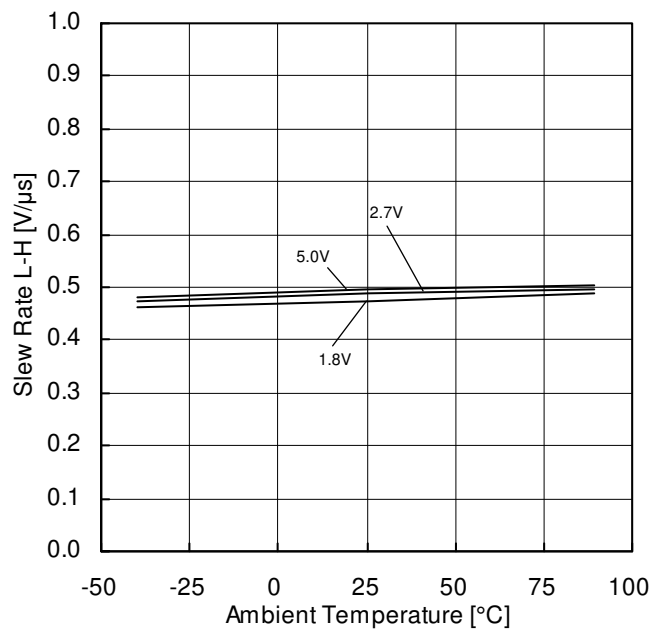

Figure 21.
Slew Rate L-H – Ambient Temperature

(Note) The data above is measurement value of typical sample, it is not guaranteed.

Typical Performance Curves (Reference data) - continued
OLMR981G, LMR931G

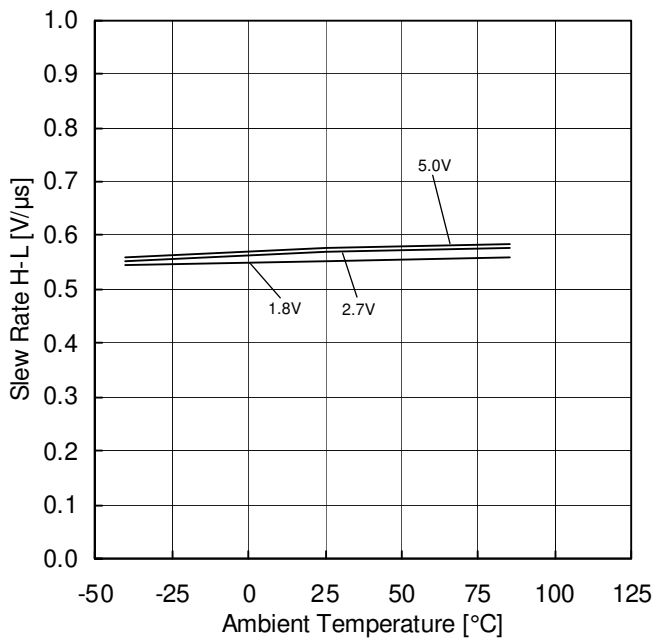

Figure 22.
Slew Rate H-L vs Ambient Temperature

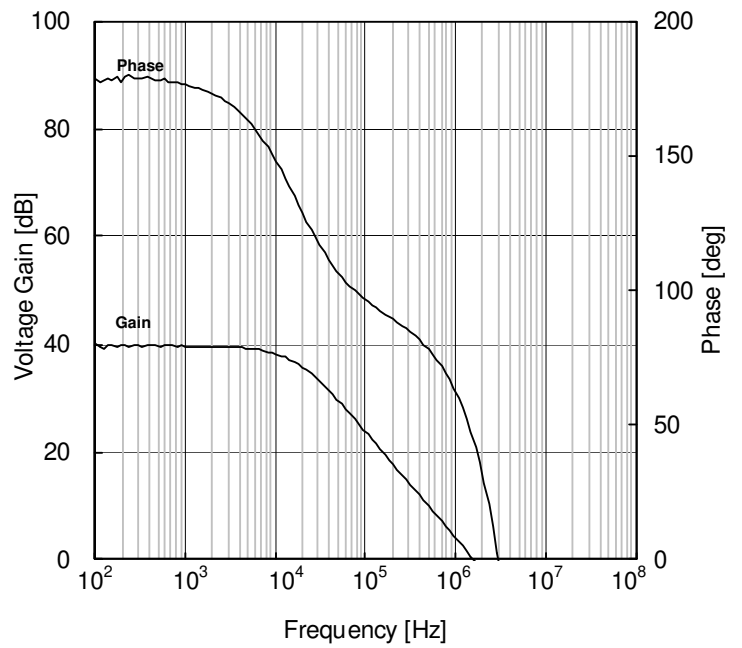

Figure 23.
Voltage Gain · Phase vs Frequency

(Note)The data above is measurement value of typical sample, it is not guaranteed.

Typical Performance Curves (Reference data) - continued
OLMR981G

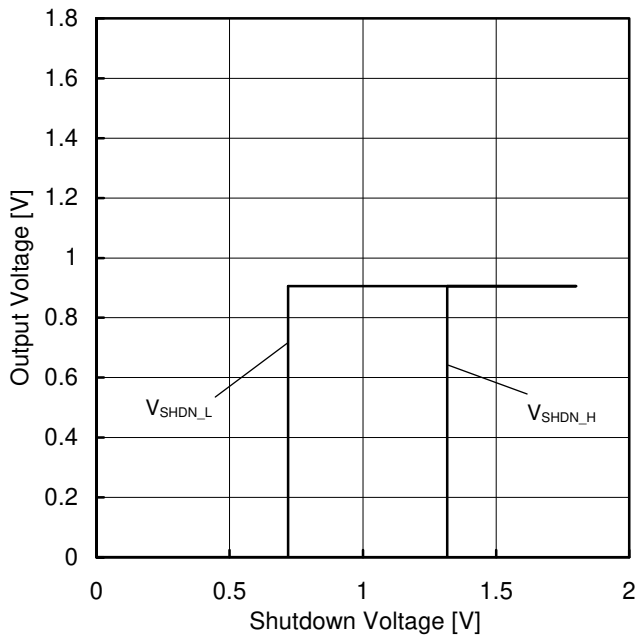

Figure 24.
Turn On/Off Voltage – Supply Voltage
(VDD=1.8V, Av=0dB, IN=0.9V)

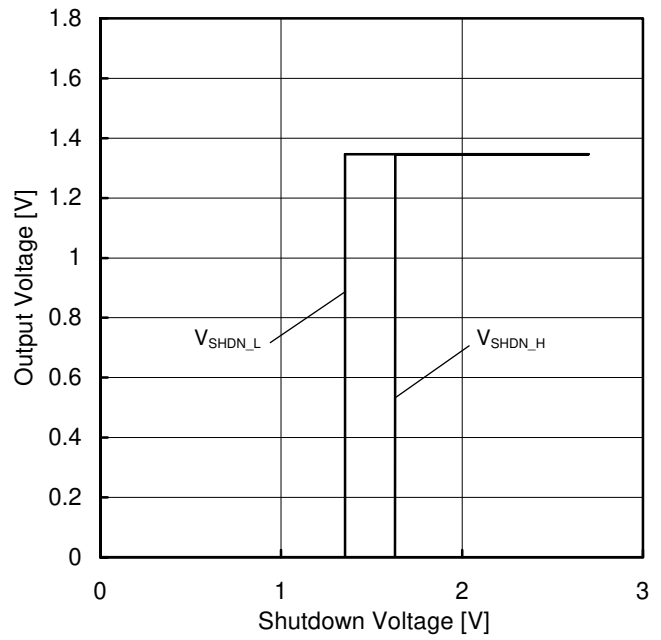

Figure 25.
Turn On/Off Voltage – Supply Voltage
(VDD=2.7V, Av=0dB, IN=1.35V)

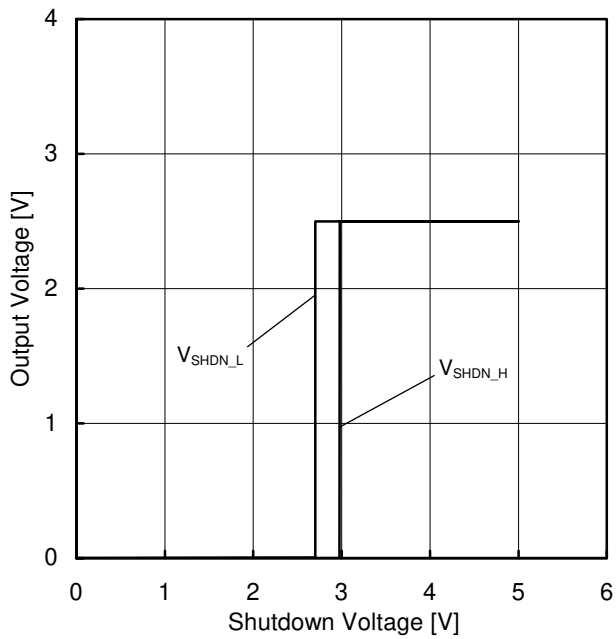

Figure 26.
Turn On/Off Voltage vs Supply Voltage
(VDD=5V, Av=0dB, IN=2.5V)

(Note) The data above is measurement value of typical sample, it is not guaranteed.

Typical Performance Curves
 OLMR982FVM, LMR932xxx

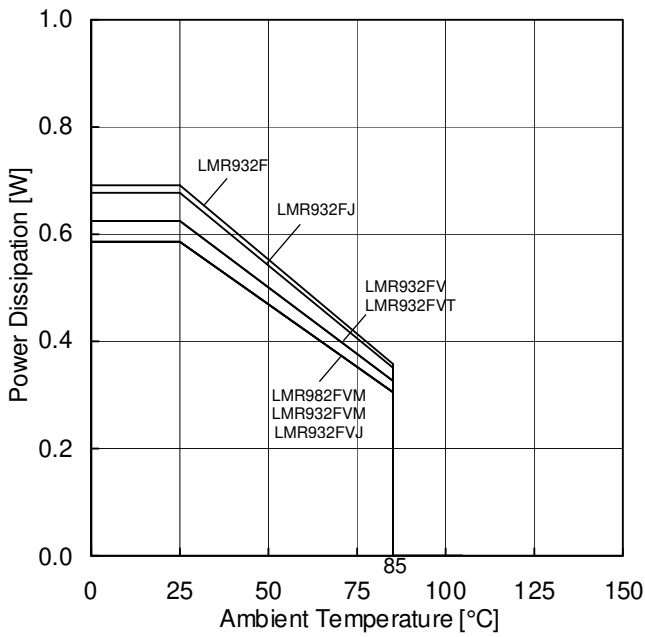

Figure 27.
 Power Dissipation vs Ambient Temperature
 (Derating Curve)

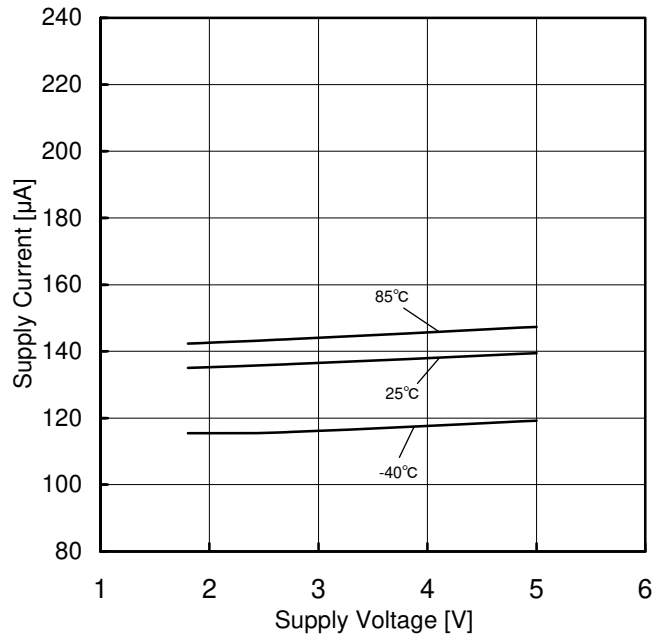

Figure 28.
 Supply Current vs Supply Voltage

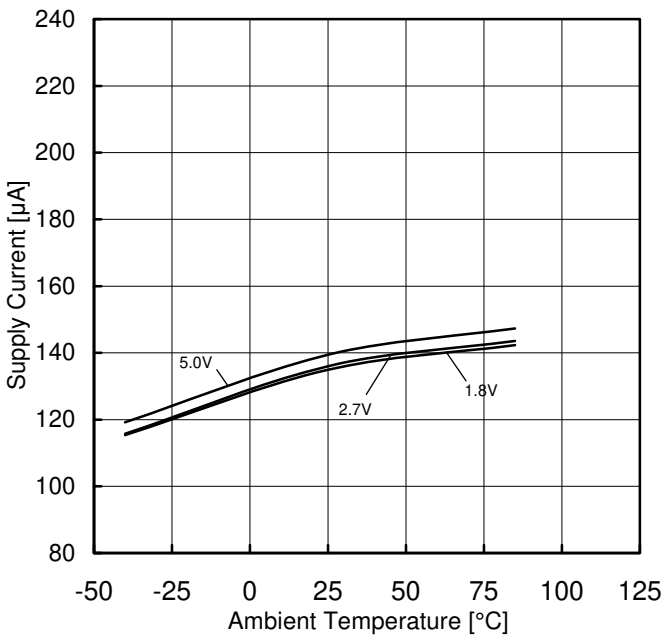

Figure 29.
 Supply Current vs Ambient Temperature

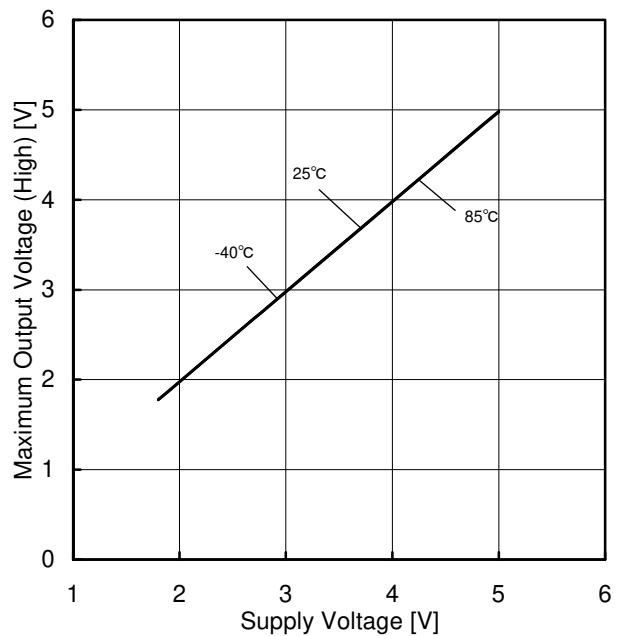

Figure 30.
 Maximum Output Voltage (High) vs Supply Voltage
 (RL=2kΩ)

(Note) The data above is measurement value of typical sample, it is not guaranteed.

Typical Performance Curves (Reference data) – continued
OLMR982FVM, LMR932xxx

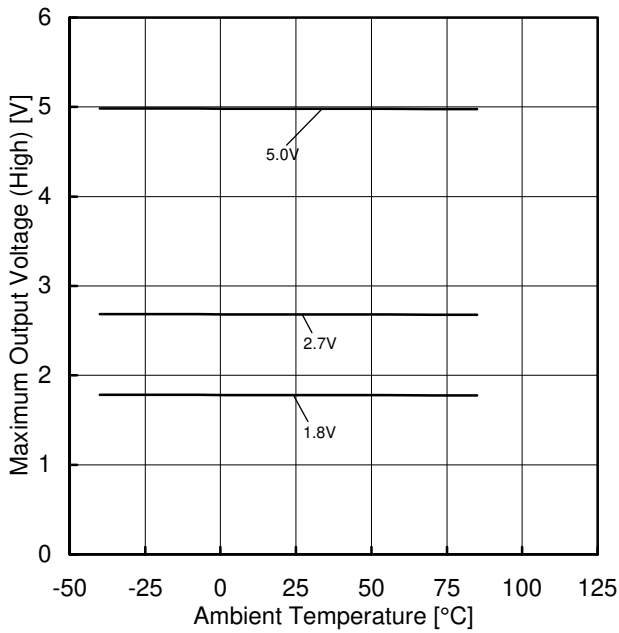

Figure 31.
Maximum Output Voltage (High) vs Ambient Temperature
($R_L=2k\Omega$)

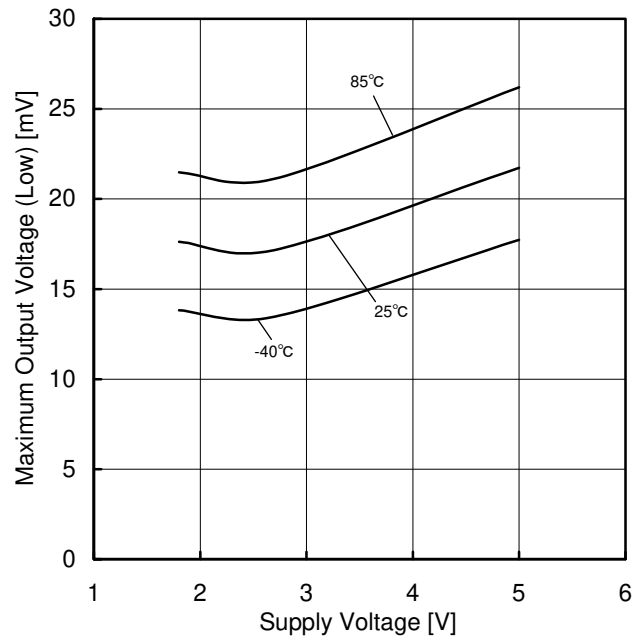

Figure 32.
Maximum Output Voltage (Low) vs Supply Voltage
($R_L=2k\Omega$)

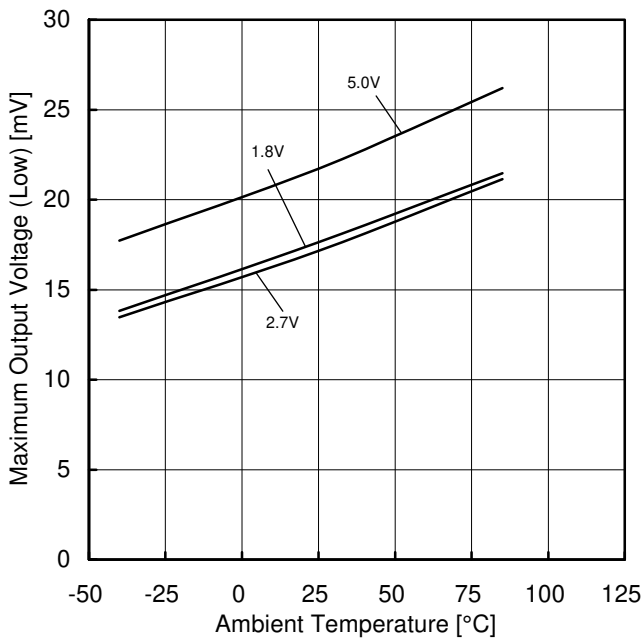

Figure 33.
Maximum Output Voltage (Low) vs Ambient Temperature
($R_L=2k\Omega$)

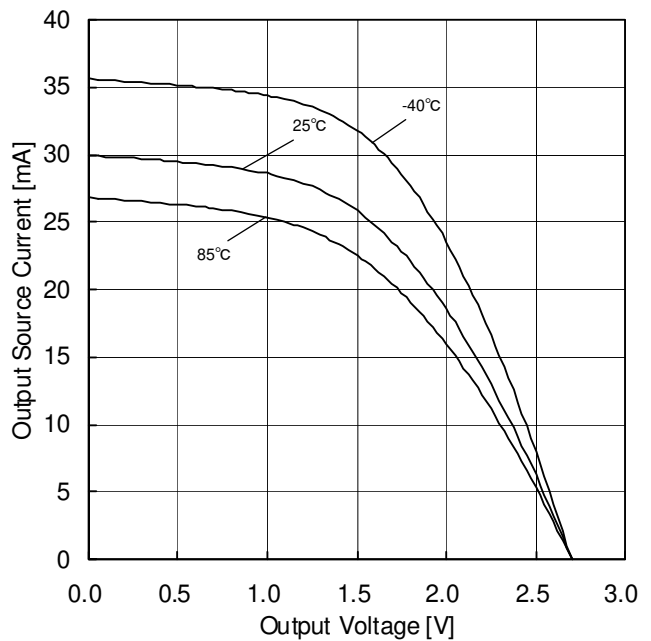

Figure 34.
Output Source Current vs Output Voltage
(VDD=2.7V)

(Note)The data above is measurement value of typical sample, it is not guaranteed.