



Chipsmall Limited consists of a professional team with an average of over 10 year of expertise in the distribution of electronic components. Based in Hongkong, we have already established firm and mutual-benefit business relationships with customers from,Europe,America and south Asia,supplying obsolete and hard-to-find components to meet their specific needs.

With the principle of “Quality Parts,Customers Priority,Honest Operation,and Considerate Service”,our business mainly focus on the distribution of electronic components. Line cards we deal with include Microchip,ALPS,ROHM,Xilinx,Pulse,ON,Everlight and Freescale. Main products comprise IC,Modules,Potentiometer,IC Socket,Relay,Connector.Our parts cover such applications as commercial,industrial, and automotives areas.

We are looking forward to setting up business relationship with you and hope to provide you with the best service and solution. Let us make a better world for our industry!



Contact us

Tel: +86-755-8981 8866 Fax: +86-755-8427 6832

Email & Skype: info@chipsmall.com Web: www.chipsmall.com

Address: A1208, Overseas Decoration Building, #122 Zhenhua RD., Futian, Shenzhen, China



LN64

GaAs Infrared Light Emitting Diode

For Optical Control Systems

■ Features

- High-power output: $P_o=7\text{mW}$ (typ.)
- Suited for use with silicon photo detectors
- Good linearity (P_o vs I_F)
- Wide beam angle: $\theta=45$ deg. (typ.)
- Transparent epoxy package

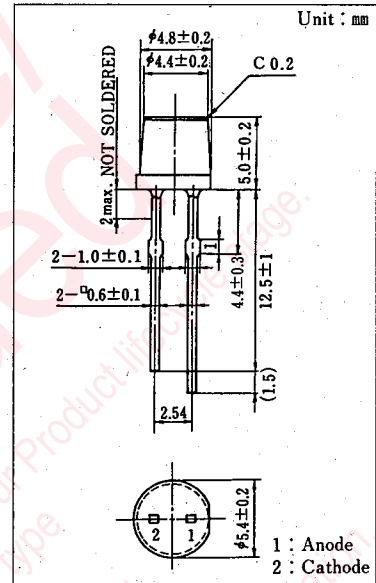

■ Absolute Maximum Ratings ($T_a=25^\circ\text{C}$)

Item	Symbol	Value	Unit
Power Dissipation	P_D	160	mW
Forward Current (DC)	I_F	100	mA
Pulse Forward Current	I_{FP}^*	1.5	A
Reverse Voltage (DC)	V_R	3	V
Operating Ambient Temperature	T_{opr}	$-25 \sim +85$	$^\circ\text{C}$
Storage Temperature	T_{stg}	$-40 \sim +100$	$^\circ\text{C}$

* $f=100\text{Hz}$, Duty Cycle=0.1%

■ Electro-Optical Characteristics ($T_a=25^\circ\text{C}$)

Item	Symbol	Condition	min.	typ.	max.	Unit
Optical Power Output	P_o	$I_F=50\text{mA}$	3.5	7		mW
Peak Emission Wavelength	λ_P	$I_F=50\text{mA}$		950		nm
Spectral Band Width	$\Delta\lambda$	$I_F=50\text{mA}$		50		nm
Forward Voltage (DC)	V_F	$I_F=100\text{mA}$		1.3	1.6	V
Reverse Current (DC)	I_R	$V_R=3\text{V}$			10	μA
Capacitance between Terminals	C_t	$V_R=0$, $f=1\text{MHz}$		35		pF
Beam Half Angle	θ	Measured from the optical axis to the half power point		45		deg.

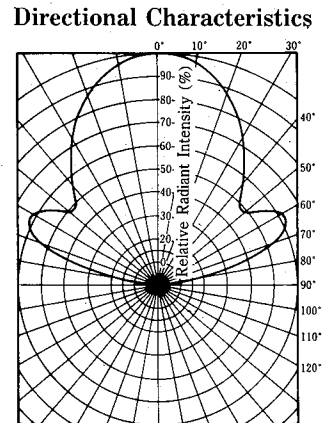
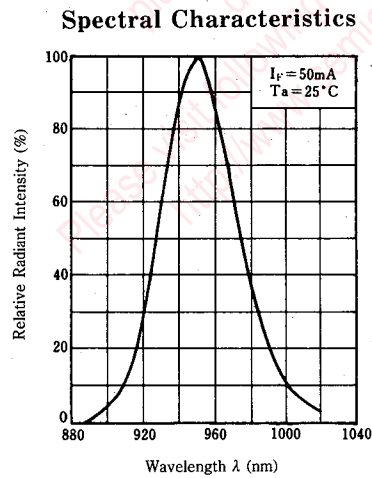
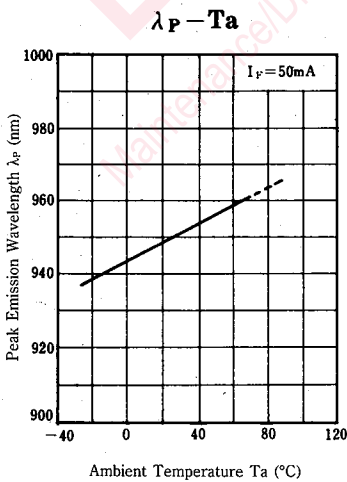
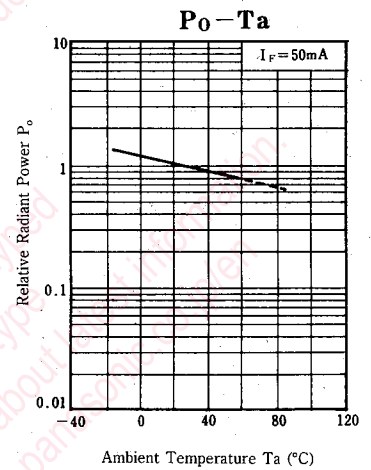
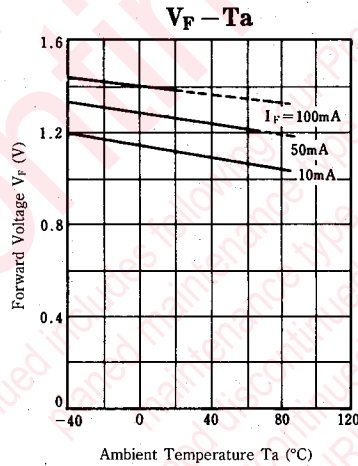
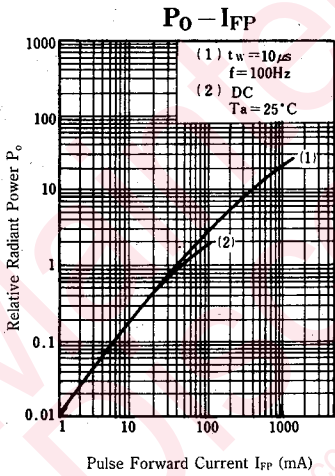
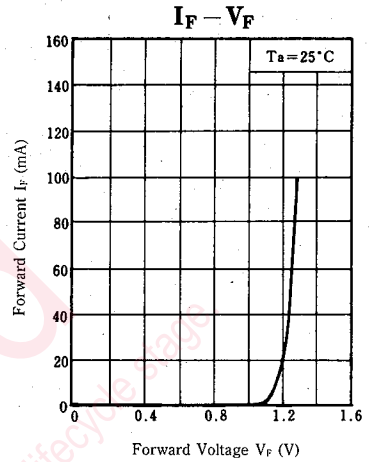
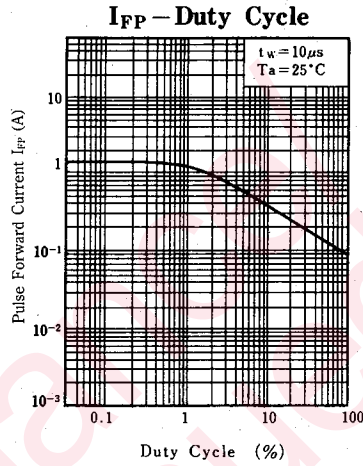
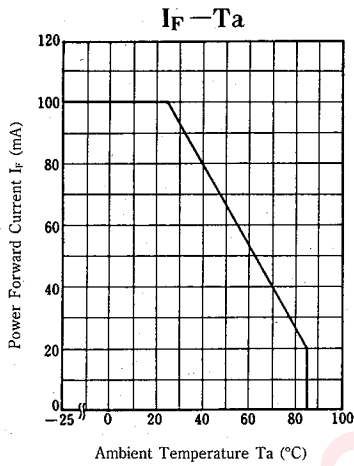

Request for your special attention and precautions in using the technical information and semiconductors described in this book

- (1) If any of the products or technical information described in this book is to be exported or provided to non-residents, the laws and regulations of the exporting country, especially, those with regard to security export control, must be observed.
- (2) The technical information described in this book is intended only to show the main characteristics and application circuit examples of the products. No license is granted in and to any intellectual property right or other right owned by Panasonic Corporation or any other company. Therefore, no responsibility is assumed by our company as to the infringement upon any such right owned by any other company which may arise as a result of the use of technical information described in this book.
- (3) The products described in this book are intended to be used for standard applications or general electronic equipment (such as office equipment, communications equipment, measuring instruments and household appliances).
Consult our sales staff in advance for information on the following applications:
 - Special applications (such as for airplanes, aerospace, automobiles, traffic control equipment, combustion equipment, life support systems and safety devices) in which exceptional quality and reliability are required, or if the failure or malfunction of the products may directly jeopardize life or harm the human body.
 - Any applications other than the standard applications intended.
- (4) The products and product specifications described in this book are subject to change without notice for modification and/or improvement. At the final stage of your design, purchasing, or use of the products, therefore, ask for the most up-to-date Product Standards in advance to make sure that the latest specifications satisfy your requirements.
- (5) When designing your equipment, comply with the range of absolute maximum rating and the guaranteed operating conditions (operating power supply voltage and operating environment etc.). Especially, please be careful not to exceed the range of absolute maximum rating on the transient state, such as power-on, power-off and mode-switching. Otherwise, we will not be liable for any defect which may arise later in your equipment.
 - Even when the products are used within the guaranteed values, take into the consideration of incidence of break down and failure mode, possible to occur to semiconductor products. Measures on the systems such as redundant design, arresting the spread of fire or preventing glitch are recommended in order to prevent physical injury, fire, social damages, for example, by using the products.
- (6) Comply with the instructions for use in order to prevent breakdown and characteristics change due to external factors (ESD, EOS, thermal stress and mechanical stress) at the time of handling, mounting or at customer's process. When using products for which damp-proof packing is required, satisfy the conditions, such as shelf life and the elapsed time since first opening the packages.
- (7) This book may be not reprinted or reproduced whether wholly or partially, without the prior written permission of our company.