



Chipsmall Limited consists of a professional team with an average of over 10 year of expertise in the distribution of electronic components. Based in Hongkong, we have already established firm and mutual-benefit business relationships with customers from,Europe,America and south Asia,supplying obsolete and hard-to-find components to meet their specific needs.

With the principle of "Quality Parts,Customers Priority,Honest Operation,and Considerate Service",our business mainly focus on the distribution of electronic components. Line cards we deal with include Microchip,ALPS,ROHM,Xilinx,Pulse,ON,Everlight and Freescale. Main products comprise IC,Modules,Potentiometer,IC Socket,Relay,Connector.Our parts cover such applications as commercial,industrial, and automotives areas.

We are looking forward to setting up business relationship with you and hope to provide you with the best service and solution. Let us make a better world for our industry!



Contact us

Tel: +86-755-8981 8866 Fax: +86-755-8427 6832

Email & Skype: info@chipsmall.com Web: www.chipsmall.com

Address: A1208, Overseas Decoration Building, #122 Zhenhua RD., Futian, Shenzhen, China

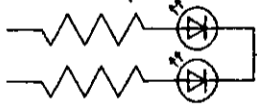
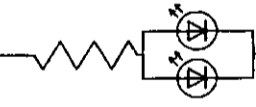

Approved	Checked	Designed	DEVELOPMENT SPECIFICATION			
	<i>H. H.</i>	<i>T. Taketa</i>	P/N: LNJ316C83RU			
			TEMPORARY			
T Y P E	Green Light Emitting Diode					
APPLICATION	Indicators					
MATERIAL	InGaAlP					
OUTLINE	Attached					
ABSOLUTE MAXIMUM RATINGS	P	*1 I _{FP}	I _{FDC}	V _R	Topr	Tstg
	55	60	20	4	-30~+85	-40~+100
	mW	mA	mA	V	°C	°C
CONDITION	T _a = 25 ± 3°C					
Test Specification						
I t e m	Symbol	C o n d i t i o n	Typ	Limit		Unit
				Min	Max	
Forward Voltage	V _F	I _F = 10 mA	2.03		2.5	V
Reverse Leakage Current	I _R	V _R = 4 V			10	μA
Luminous Intensity *2	I _O	I _F = 10 mA DC	22	11		mcd
Peak Emission Wavelength	λ _p	I _F = 10 mA DC	575			nm
Spectral Line Half Width	Δλ	I _F = 10 mA DC	15			nm
*1. The Condition of I _{FP} is duty 10 % , Pulse width 1 ms *2. Tolerance of luminous intensity : ±20%.						
NOTE						
★1. Please contact the Panasonic local office if you design at low current (below 1mA DC) or pulse current operation and have any questions.						
★2. Soldering conditions.....Refer to Handling note.						
★3. Compositions of the lead Cu/Ni/Au plating						
★4. Package...Clear type.						
★4. Beware of destruction by static electricity in handling the LED.						
★5. Circuit to operate LED.						
			(A) Recommended circuit. (B) The difference of brightness between the LED could be found due to the V _F characteristics of each LED.			
						
(A)		(B)				
Mar. 26. 2001						

Approved	Checked	Designed
	<i>M. W.</i>	<i>T. Takata</i>

DEVELOPMENT SPECIFICATION

P/N: LN316C83RU

TEMPORARY

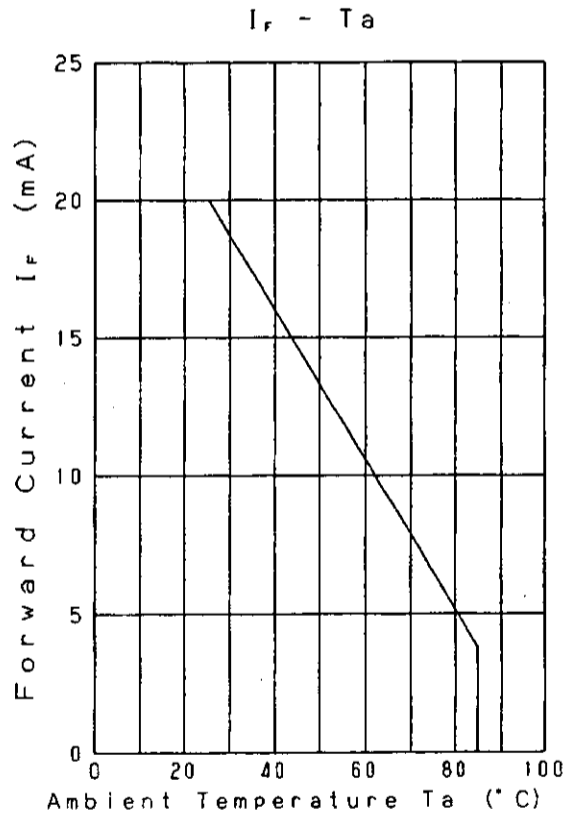
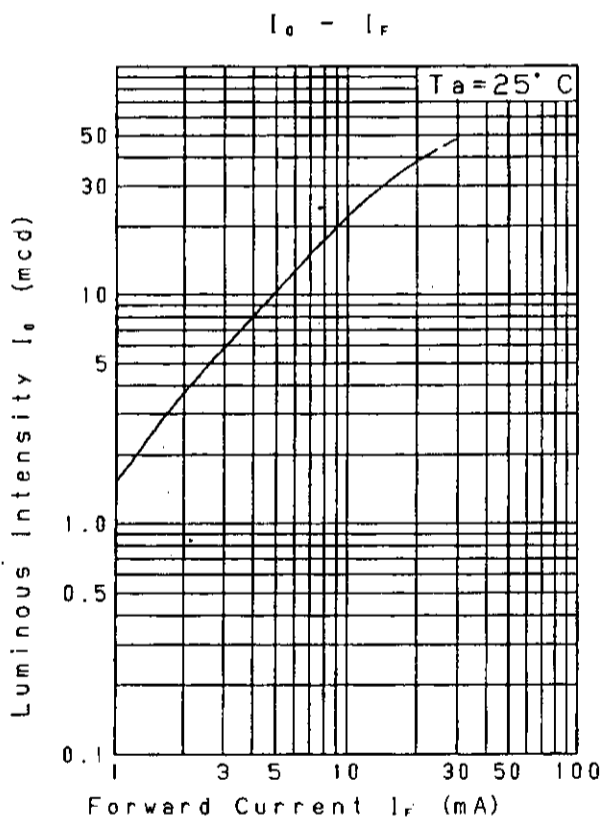
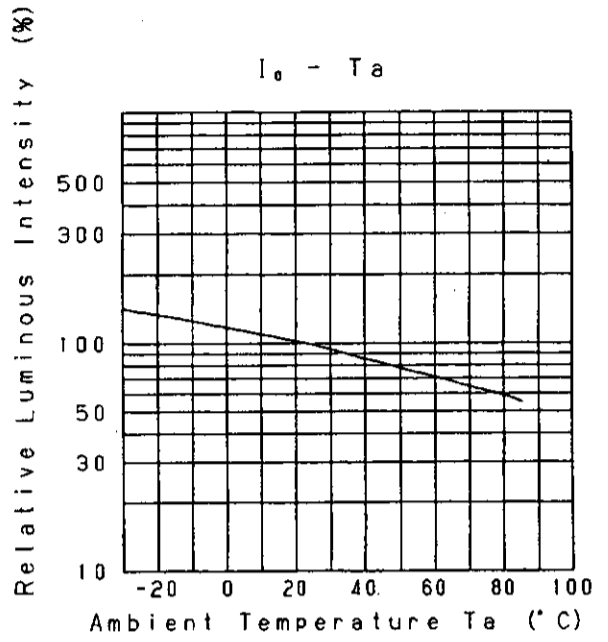
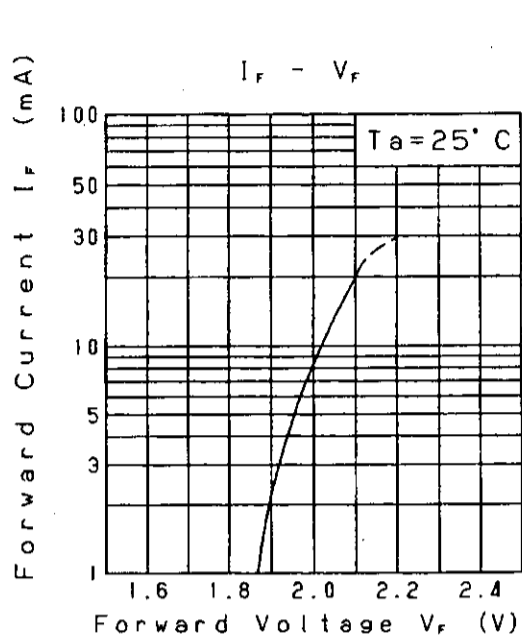

Mar. 26, 2001

Process

KAGOSHIMA MATSUYITA ELECTRONICS CO., LTD.

40 41 000 0100

Approved	Checked	Designed
	<i>M. Hi</i>	<i>T. Takata</i>

DEVELOPMENT SPECIFICATION

P/N: LNJ316C83RU

TEMPORARY

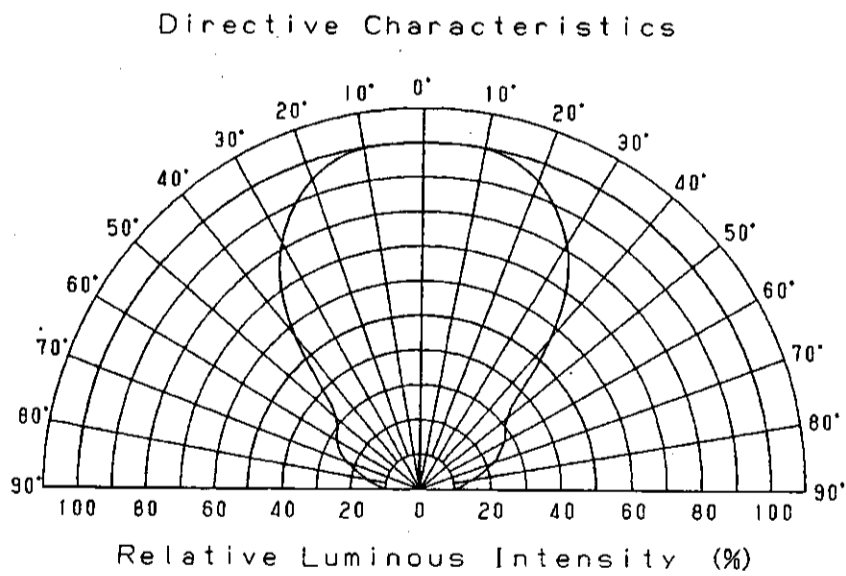
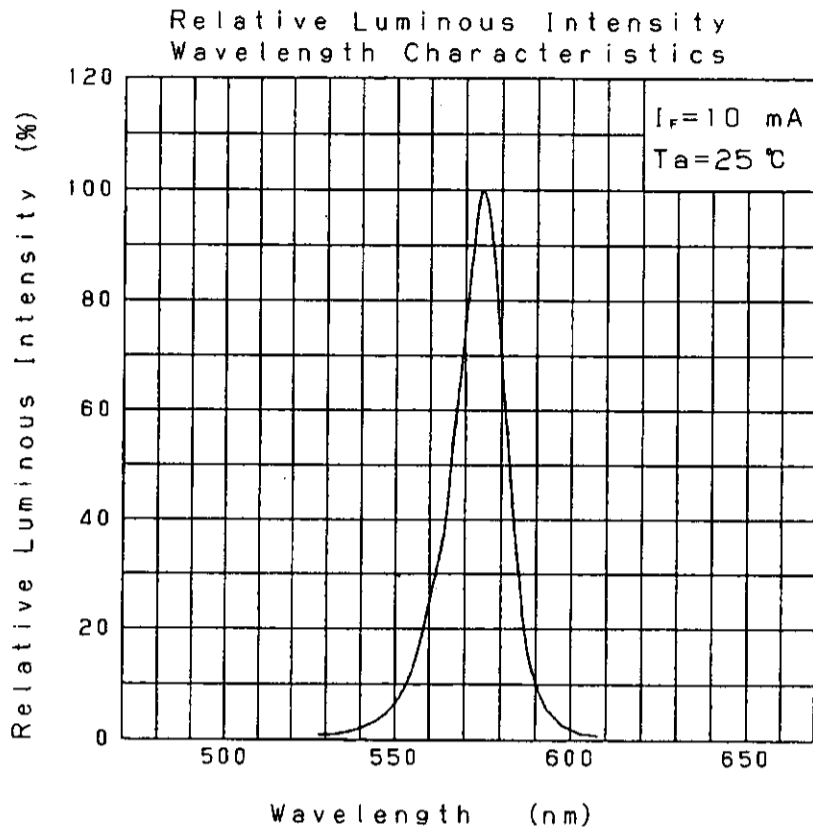

Mar. 26. 2001

Approved	Checked	Designed	DEVELOPMENT SPECIFICATION (OUTLINE) P/N: LNJ316C83RU	TEMPORARY
	<i>M. W.</i>	<i>T. Tabata</i>		

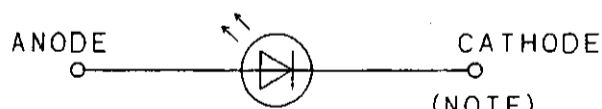
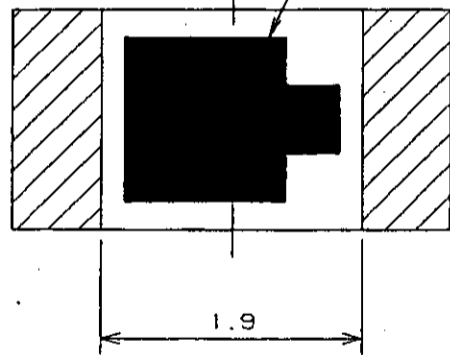
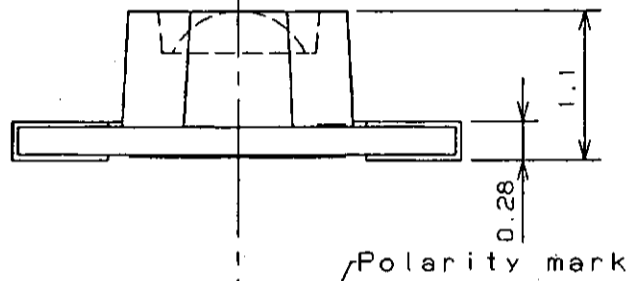
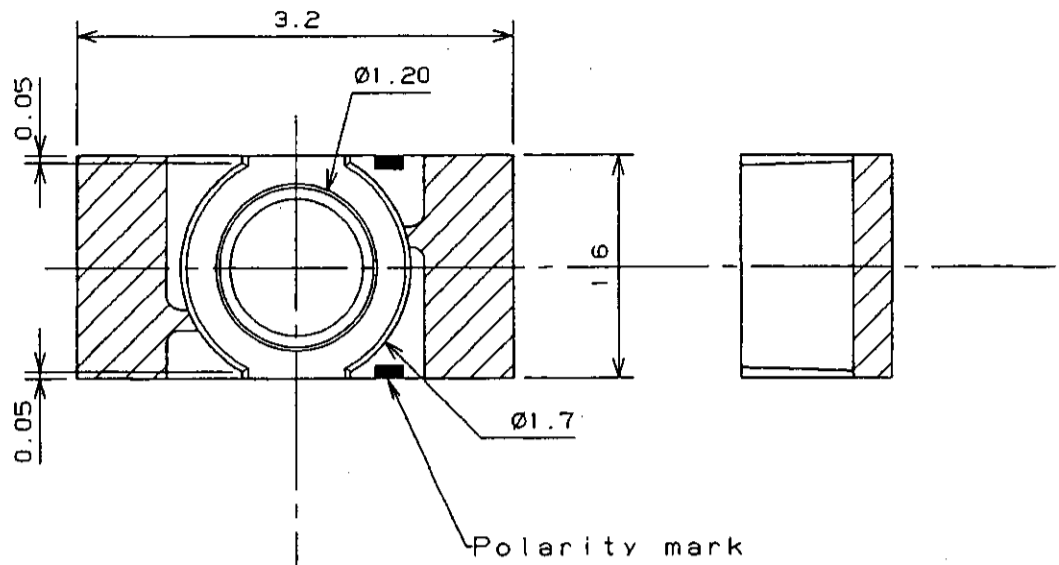

- (NOTE)
1. Unit: mm
 2. Tolerance unless specified is ± 0.15 .
 3. indicate Au terminal.

Mar. 26. 2001			
---------------	--	--	--