



Chipsmall Limited consists of a professional team with an average of over 10 year of expertise in the distribution of electronic components. Based in Hongkong, we have already established firm and mutual-benefit business relationships with customers from,Europe,America and south Asia,supplying obsolete and hard-to-find components to meet their specific needs.

With the principle of “Quality Parts,Customers Priority,Honest Operation,and Considerate Service”,our business mainly focus on the distribution of electronic components. Line cards we deal with include Microchip,ALPS,ROHM,Xilinx,Pulse,ON,Everlight and Freescale. Main products comprise IC,Modules,Potentiometer,IC Socket,Relay,Connector.Our parts cover such applications as commercial,industrial, and automotives areas.

We are looking forward to setting up business relationship with you and hope to provide you with the best service and solution. Let us make a better world for our industry!



Contact us

Tel: +86-755-8981 8866 Fax: +86-755-8427 6832

Email & Skype: info@chipsmall.com Web: www.chipsmall.com

Address: A1208, Overseas Decoration Building, #122 Zhenhua RD., Futian, Shenzhen, China





TAIWAN
EXCELLENCE 2012



■ Features

- Constant Current mode output
- Plastic housing with Class II design
- Built-in active PFC function
- Class 2 power unit
- IP67 rating for indoor or outdoor installations
- Function: 3 in 1 dimming
- Typical lifetime > 50000 hours
- 5 years warranty

■ Applications

- LED panel lighting
- LED downlight
- LED decorative lighting
- LED tunnel lighting
- Moving sign
- Type "HL" for use in Class I, Division 2 hazardous (Classified) location.

■ Description

LPF-90D series is a 90W AC/DC LED driver featuring the constant current output. LPF-90D operates from 90~305VAC and offers models with different rated voltage ranging between 15V and 54V. Thanks to the high efficiency up to 90.5%, with the fanless design, the entire series is able to operate for -40°C ~ +70°C case temperature under free air convection. The entire series is rated with IP67 ingress protection level and is suitable to work for a variety of applications at dry, damp or wet locations. LPF-90D is equipped with the 3 in 1 dimming function so as to provide the design flexibility for LED lighting system.

■ Model Encoding

LPF - 90D - 24

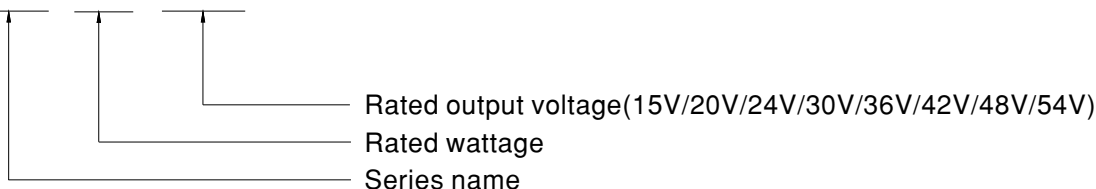

SPECIFICATION

| MODEL | LPF-90D-15 | LPF-90D-20 | LPF-90D-24 | LPF-90D-30 | LPF-90D-36 | LPF-90D-42 | LPF-90D-48 | LPF-90D-54 | | |
|--------------|--|---|------------|------------|------------|------------|------------|------------|------------|--|
| OUTPUT | DC VOLTAGE | 15V | 20V | 24V | 30V | 36V | 42V | 48V | 54V | |
| | RATED CURRENT | 5A | 4.5A | 3.75A | 3A | 2.5A | 2.15A | 1.88A | 1.67A | |
| | RATED POWER <small>Note.5</small> | 75W | 90W | 90W | 90W | 90W | 90.3W | 90.24W | 90.18W | |
| | CONSTANT CURRENT REGION <small>Note.2</small> | 9 ~ 15V | 12 ~ 20V | 14.4 ~ 24V | 18 ~ 30V | 21.6 ~ 36V | 25.2 ~ 42V | 28.8 ~ 48V | 32.4 ~ 54V | |
| | CURRENT RIPPLE | 5.0% max. @rated current | | | | | | | | |
| | CURRENT TOLERANCE | ±5.0% | | | | | | | | |
| | SETUP, RISE TIME <small>Note.6</small> | 1200ms, 200ms / 115VAC 500ms, 200ms / 230VAC | | | | | | | | |
| | HOLD UP TIME (Typ.) | 16ms/230VAC 16ms/115VAC | | | | | | | | |
| INPUT | VOLTAGE RANGE <small>Note.5</small> | 90 ~ 305VAC 127 ~ 431VDC (Please refer to "STATIC CHARACTERISTIC" section) | | | | | | | | |
| | FREQUENCY RANGE | 47 ~ 63Hz | | | | | | | | |
| | POWER FACTOR | PF ≥ 0.97/115VAC, PF ≥ 0.96/230VAC, PF ≥ 0.95/277VAC@full load (Please refer to "POWER FACTOR (PF) CHARACTERISTIC" section) | | | | | | | | |
| | TOTAL HARMONIC DISTORTION | THD < 20% (@load ≥ 60%/115VAC, 230VAC; @load ≥ 75%/277VAC) (Please refer to "TOTAL HARMONIC DISTORTION (THD)" section) | | | | | | | | |
| | EFFICIENCY (Typ.) | 89% | 89.5% | 90% | 90.5% | 90.5% | 90.5% | 90.5% | 90.5% | |
| | AC CURRENT | 0.95A / 115VAC 0.5A / 230VAC 0.4A / 277VAC | | | | | | | | |
| | INRUSH CURRENT (Typ.) | COLD START 70A (twidth=435µs measured at 50% Ipeak) at 230VAC; Per NEMA 410 | | | | | | | | |
| | MAX. No. of PSUs on 16A CIRCUIT BREAKER | 4 units (circuit breaker of type B) / 6 units (circuit breaker of type C) at 230VAC | | | | | | | | |
| | LEAKAGE CURRENT | <0.75mA / 240VAC | | | | | | | | |
| PROTECTION | OVER CURRENT | 95 ~ 108% Constant current limiting, recovers automatically after fault condition is removed | | | | | | | | |
| | OVER VOLTAGE | 18 ~ 21V | 23 ~ 27V | 28 ~ 34V | 34 ~ 38V | 41 ~ 46V | 47 ~ 53V | 54 ~ 60V | 59 ~ 65V | |
| | | Shut down o/p voltage, re-power on to recover | | | | | | | | |
| | OVER TEMPERATURE | Shut down o/p voltage, re-power on to recover | | | | | | | | |
| ENVIRONMENT | WORKING TEMP. | Tcase=-40 ~ +70°C (Please refer to "OUTPUT LOAD vs TEMPERATURE" section) | | | | | | | | |
| | MAX. CASE TEMP. | Tcase=+70°C | | | | | | | | |
| | WORKING HUMIDITY | 20 ~ 95% RH non-condensing | | | | | | | | |
| | STORAGE TEMP., HUMIDITY | -40 ~ +80°C, 10 ~ 95% RH | | | | | | | | |
| | TEMP. COEFFICIENT | ±0.03%/°C (0 ~ 50°C) | | | | | | | | |
| | VIBRATION | 10 ~ 500Hz, 5G 12min./1cycle, period for 72min. each along X, Y, Z axes | | | | | | | | |
| SAFETY & EMC | SAFETY STANDARDS <small>Note.8</small> | UL8750(type"HL"), CSA C22.2 No.250.13-12, TUV EN61347-1, EN61347-2-13, J61347-1, J61347-2-13, EAC TP TC 004, GB19510.1, GB19510.14, IP67 approved; Design refer to UL60950-1, TUV EN60950-1 | | | | | | | | |
| | WITHSTAND VOLTAGE | I/P-O/P:3.75KVAC | | | | | | | | |
| | ISOLATION RESISTANCE | I/P-O/P:100M Ohms / 500VDC / 25°C / 70% RH | | | | | | | | |
| | EMC EMISSION <small>Note.8</small> | Compliance to EN55015, EN61000-3-2 Class C (@load ≥ 60%); EN61000-3-3, GB17743 and GB17625.1, EAC TP TC 020 | | | | | | | | |
| | EMC IMMUNITY | Compliance to EN61000-4-2, 3, 4, 5, 6, 8, 11; EN61547, light industry level (surge immunity Line-Line 2KV), EAC TP TC 020 | | | | | | | | |
| OTHERS | MTBF | 1036.4K hrs min. Telcordia SR-332 (Bellcore); 267.2Khrs min. MIL-HDBK-217F (25°C) | | | | | | | | |
| | DIMENSION | 161*61*36mm (L*W*H) | | | | | | | | |
| | PACKING | 0.7Kg; 20pcs/15Kg/0.73CUFT | | | | | | | | |
| NOTE | <ol style="list-style-type: none"> All parameters NOT specially mentioned are measured at 230VAC input, rated current and 25°C of ambient temperature. Please refer to "DRIVING METHODS OF LED MODULE". Ripple & noise are measured at 20MHz of bandwidth by using a 12" twisted pair-wire terminated with a 0.1µf & 47µf parallel capacitor. Tolerance : includes set up tolerance, line regulation and load regulation. De-rating may be needed under low input voltages. Please refer to "STATIC CHARACTERISTIC" sections for details. Length of set up time is measured at first cold start. Turning ON/OFF the driver may lead to increase of the set up time. The driver is considered as a component that will be operated in combination with final equipment. Since EMC performance will be affected by the complete installation, the final equipment manufacturers must re-qualify EMC Directive on the complete installation again. To fulfill requirements of the latest ErP regulation for lighting fixtures, this LED driver can only be used behind a switch without permanently connected to the mains. This series meets the typical life expectancy of >50,000 hours of operation when Tcase, particularly (Tc) point (or TMP, per DLC), is about 70°C or less. Please refer to the warranty statement on MEAN WELL's website at http://www.meanwell.com The ambient temperature derating of 3.5°C/1000m with fanless models and of 5°C/1000m with fan models for operating altitude higher than 2000m(6500ft). | | | | | | | | | |

■ BLOCK DIAGRAM

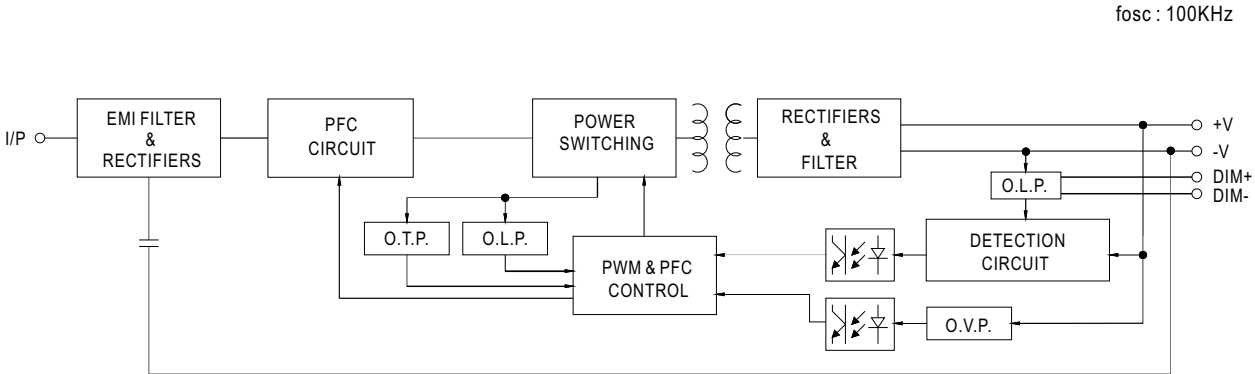

■ DRIVING METHODS OF LED MODULE

※ This series works in constant current mode to directly drive the LEDs.

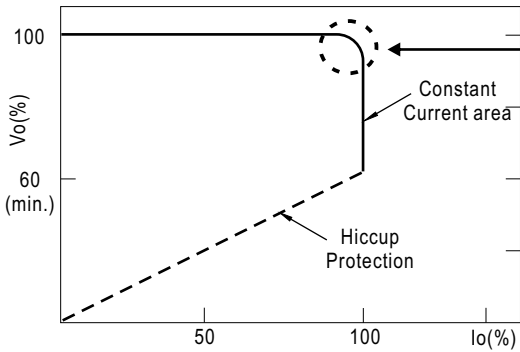

Typical output current normalized by rated current (%)

In the constant current region, the highest voltage at the output of the driver depends on the configuration of the end systems. Should there be any compatibility issues, please contact MEAN WELL.

■ DIMMING OPERATION

※ 3 in 1 dimming function

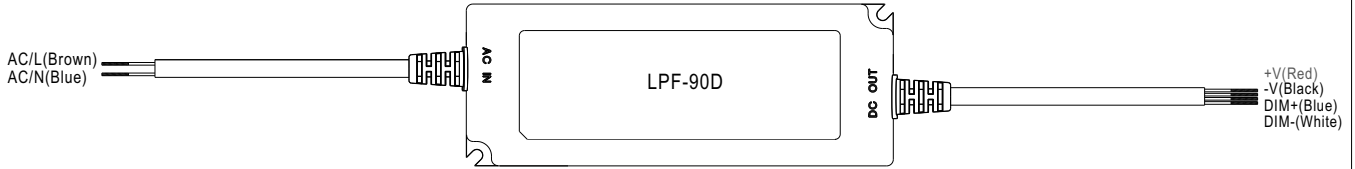

- Output constant current level can be adjusted by applying one of the three methodologies between DIM+ and DIM-: 1 ~ 10VDC, or 10V PWM signal or resistance.
- Direct connecting to LEDs is suggested. It is not suitable to be used with additional drivers.
- Dimming source current from power supply: 100 μ A (typ.)

◎ Applying additive 1 ~ 10VDC

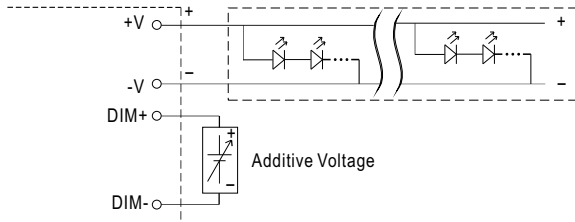

"DO NOT connect "DIM- to -V"

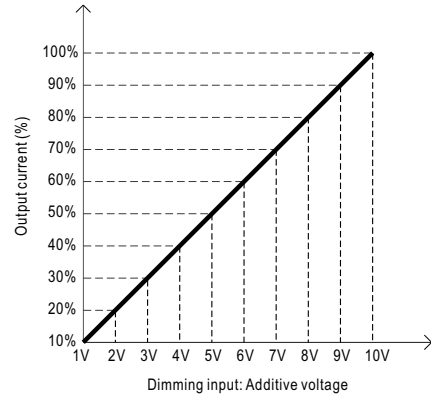

◎ Applying additive 10V PWM signal (frequency range 100Hz ~ 3KHz):

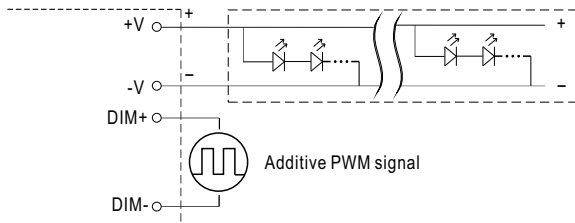

"DO NOT connect "DIM- to -V"

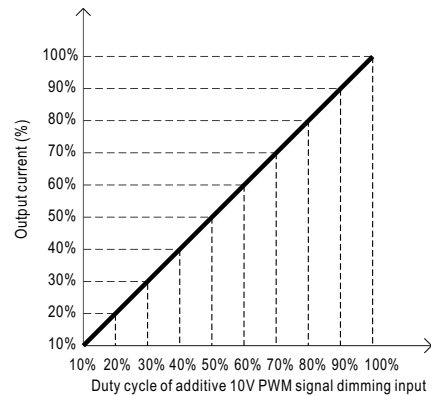

◎ Applying additive resistance:

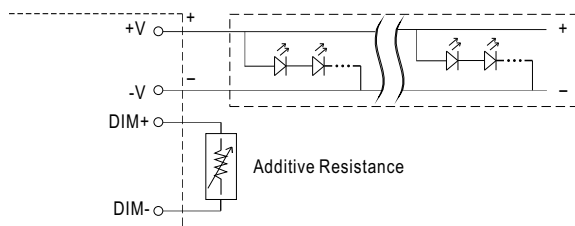

"DO NOT connect "DIM- to -V"

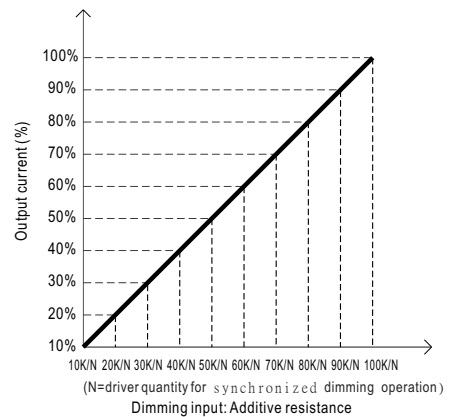

Note: In the case of turning the lighting fixture down to 0% brightness, please refer to the configuration as follow, or please contact MEAN WELL for other options.

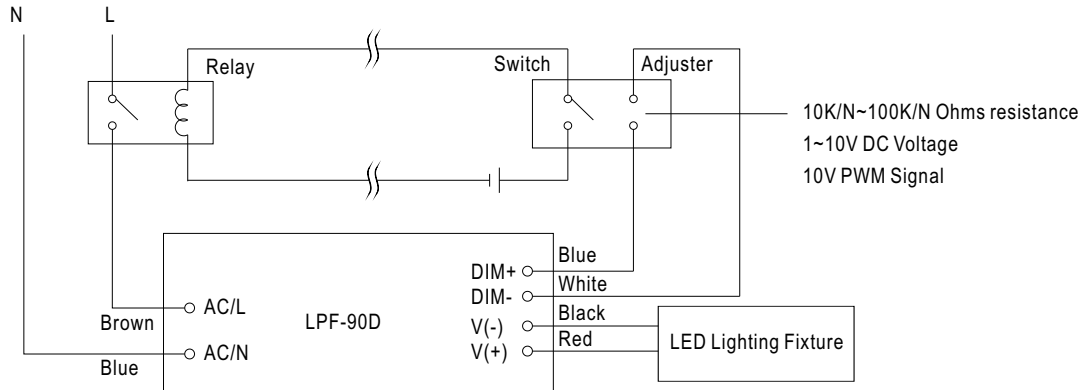

Using a switch and relay can turn ON/OFF the lighting fixture.

OUTPUT LOAD vs TEMPERATURE

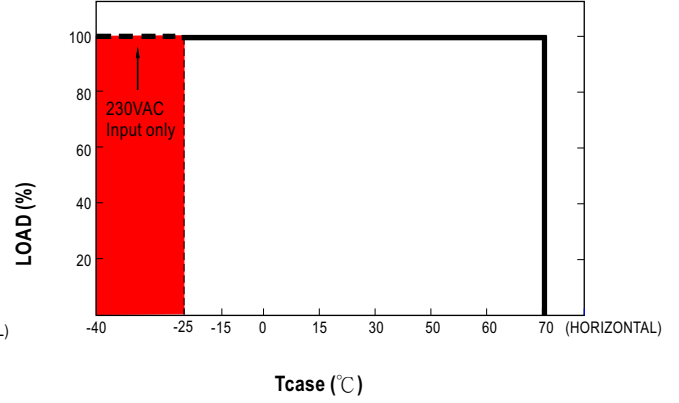
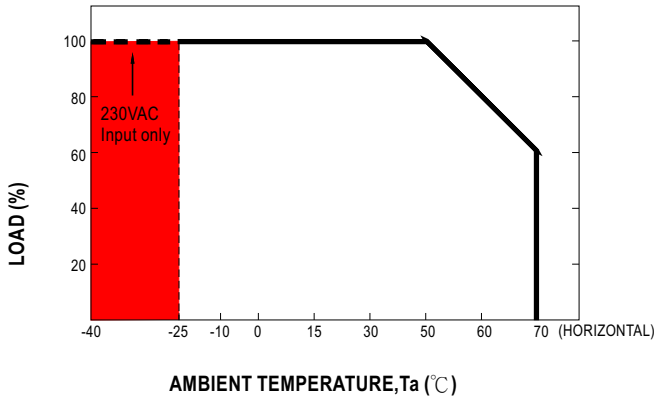

STATIC CHARACTERISTIC

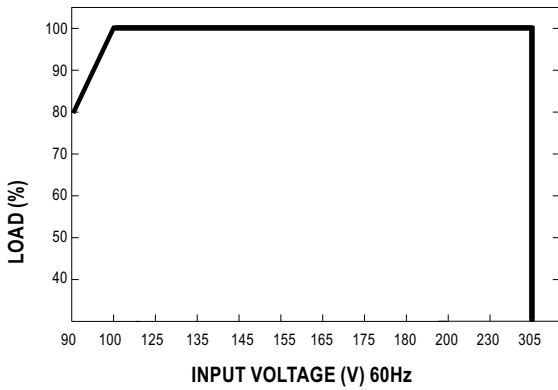

※ De-rating is needed under low input voltage.

POWER FACTOR (PF) CHARACTERISTIC

※ Tcase at 60°C

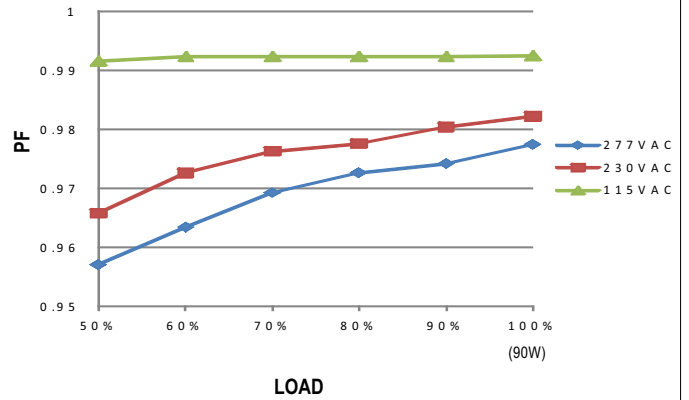

TOTAL HARMONIC DISTORTION (THD)

※ 48V Model, Tcase at 60°C

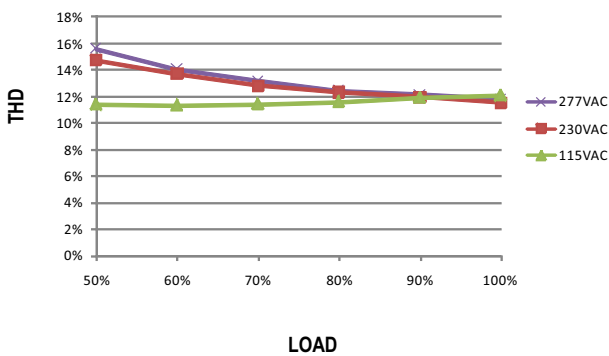

EFFICIENCY vs LOAD

LPF-90D series possess superior working efficiency that up to 90.5% can be reached in field applications.

※ 48V Model, Tcase at 60°C

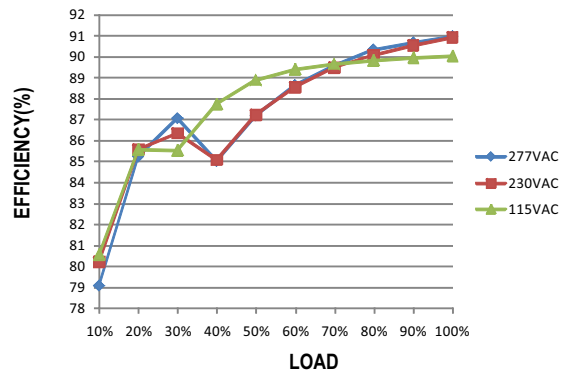

■ LIFE TIME

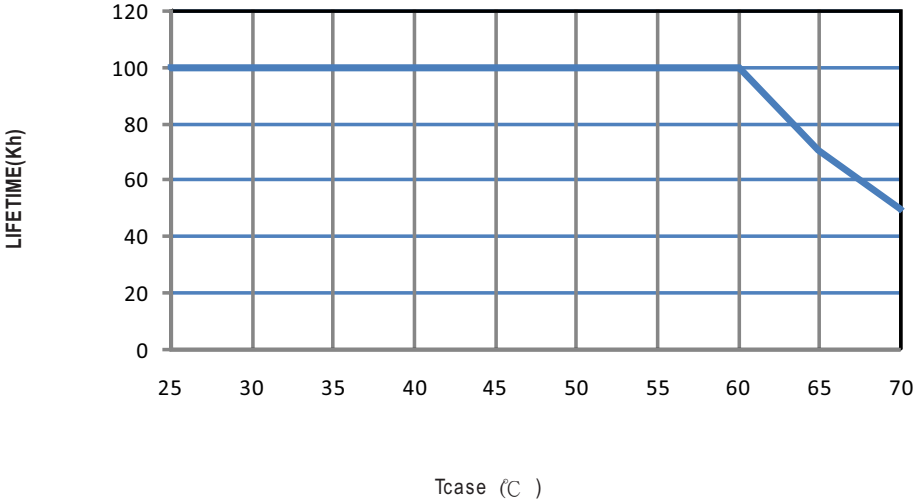

■ MECHANICAL SPECIFICATION

CASE NO.: LPF-90A Unit:mm

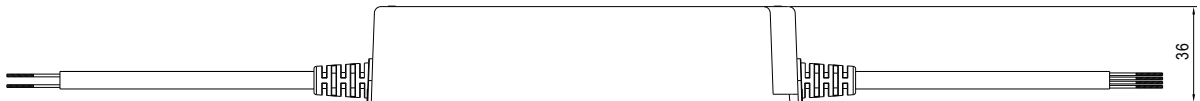
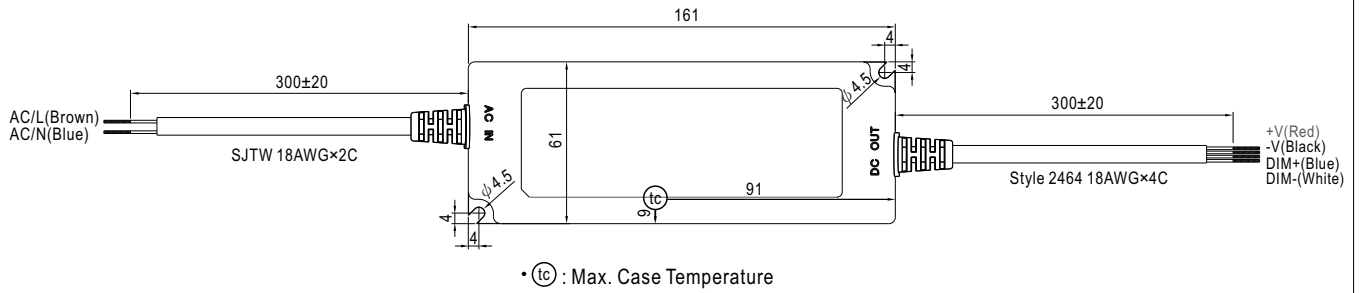

■ INSTALLATION MANUAL

Please refer to : <http://www.meanwell.com/manual.html>