



Chipsmall Limited consists of a professional team with an average of over 10 year of expertise in the distribution of electronic components. Based in Hongkong, we have already established firm and mutual-benefit business relationships with customers from,Europe,America and south Asia,supplying obsolete and hard-to-find components to meet their specific needs.

With the principle of "Quality Parts,Customers Priority,Honest Operation,and Considerate Service",our business mainly focus on the distribution of electronic components. Line cards we deal with include Microchip,ALPS,ROHM,Xilinx,Pulse,ON,Everlight and Freescale. Main products comprise IC,Modules,Potentiometer,IC Socket,Relay,Connector.Our parts cover such applications as commercial,industrial, and automotives areas.

We are looking forward to setting up business relationship with you and hope to provide you with the best service and solution. Let us make a better world for our industry!



## Contact us

Tel: +86-755-8981 8866 Fax: +86-755-8427 6832

Email & Skype: info@chipsmall.com Web: www.chipsmall.com

Address: A1208, Overseas Decoration Building, #122 Zhenhua RD., Futian, Shenzhen, China



# LPS69273NT Omni SISO 3G-4G LTE Disk-Puck Antenna

## LOW PROFILE SURFACE MOUNT 698-960/1710-2700 MHZ DISK-PUCK ANTENNA

The Laird Patent Pending LPS69273NT antenna is a multiband low profile omnidirectional disk-puck antenna operating over the 698-960 MHz and 1710-2700 MHz frequency bands. Designed to be a surface mount antenna that performs well on metallic and non-metallic\* surfaces, the antenna is ideal for use in Machine-to-Machine (M2M) applications. The housing incorporates a low profile, rugged design that conforms to IP67 standards making the antenna suitable for both indoor and outdoor applications.



Patent Pending LPS69273NT

### FEATURES

- Low Profile aesthetically neutral housing
- Surface mount with stud & locking nut
- Designed for both Indoor & Outdoor applications
- IP67 rated for harsh environmental applications

### BENEFITS

- 3G/4G LTE & Wi-Fi communications in a single solution
- Applicable for both metal and non-metallic\* surface

### MARKETS

- Machine-to-Machine (M2M)
- LTE & 3G/4G Cellular, Wi-Fi & WLAN
- Utilities, Remote Monitoring, Kiosks & ATMs
- Warehouse, Offices & Meeting rooms
- Hotels, Museums, Libraries & Retail Malls
- Airport, Bus Terminals & Train Stations
- Other In-Building & Outdoor areas

## SPECIFICATIONS

PARAMETER	SPECIFICATIONS							
Frequency Bands, MHz	698-806	824-894	880-960	1710-1880	1850-1990	1910-2170	2300-2500	2500-2700
VSWR (Typ)	<2.7:1	<2.9:1	<2.8:1	<2.1:1	<1.7:1	<1.7:1	<2.3:1	<2.3:1
VSWR (Max)	<3.0:1	<3.0:1	<3.0:1	<3.0:1	<3.0:1	<3.0:1	<3.0:1	<3.0:1
Peak Gain, dBi (Typ)								
On Metal Housing	2.1	0.7	1.7	5.4	4.6	4.5	3.4	3.7
On Plastic Housing w/ Ground Plane Kit	2.4	1.1	2.3	5.5	4.4	4.0	3.8	3.8
Peak Gain, dBi (Max)								
On Metal Housing	2.5	1.1	2.3	5.9	4.8	4.9	3.8	4.0
On Plastic Housing w/ Ground Plane Kit	2.9	1.4	3.1	5.9	5.3	4.3	4.4	4.3
Nominal Impedance	50Ω							
Polarization	Linear, Vertical							
Azimuth Beam Width	Omnidirectional							
Max Power (ambient temp of 25°C)	10 Watts							
Dimensions (diameter x height)	Ø127mm X 31mm (Ø 5" X 1.22")							
Weight	Approximately 0.20 kg ( 0.44 lbs.)							
Antenna Color / Radome	Black / PC, UV Stable, UL94 V-0 Material							
Storage Temperature Range (°C)	-40°C to +85°C ( -40°F to +185°F )							
Operational Temperature Range (°C)	-30°C to +70°C ( -22°F to +158°F )							
Ingress Protection Rating	IP67							
RoHS Compliance	Yes							
Cable Type	RG316							

\* Requires a 300mm diameter Ground Plane Kit (order separately with P/N HKIT-LPx-001)

## CONNECTORS

MODEL NUMBER	CABLE LENGTH	CONNECTOR
LPS69273NT-61SMAM	610 mm (24 in)	SMA- male
LPS69273NT-61RTNM	610 mm (24 in)	RTNC- male

Americas: +1.847.839.6907  
IAS-AmericasEastSales@lairdtech.com

Europe: +44.1628.858941  
IAS-EUSales@lairdtech.com

Asia:+86.21.5855.0827.127 IAS-  
AsiaSales@lairdtech.com

[www.lairdtech.com](http://www.lairdtech.com)

Laird warrants to the original end user customer of its products that its products are free from defects in material and workmanship. Subject to conditions and limitations Laird will, at its option, either repair or replace any part of its products that prove defective by reason of improper workmanship or materials. This limited warranty is in force for the useful lifetime of the original end product into which the Laird product is installed. Useful lifetime of the original end product may vary but is not to exceed five (5) years from the original date of the end product purchase.



### Radiation Pattern at 698 MHz

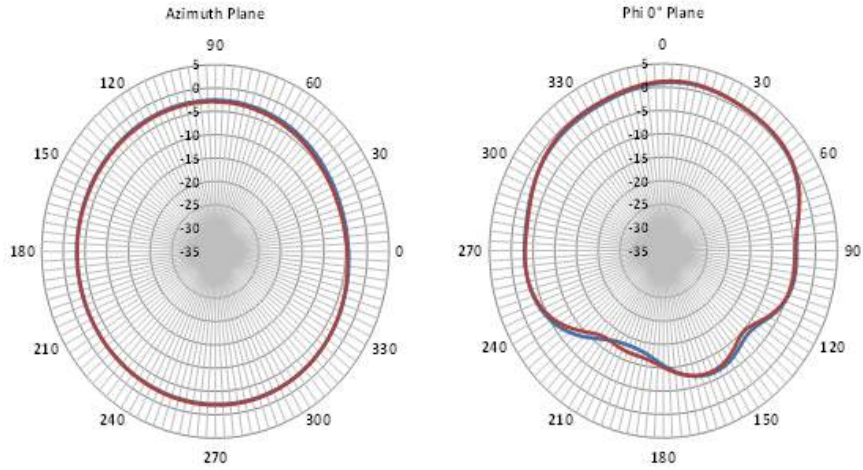

### Radiation Pattern at 880 MHz

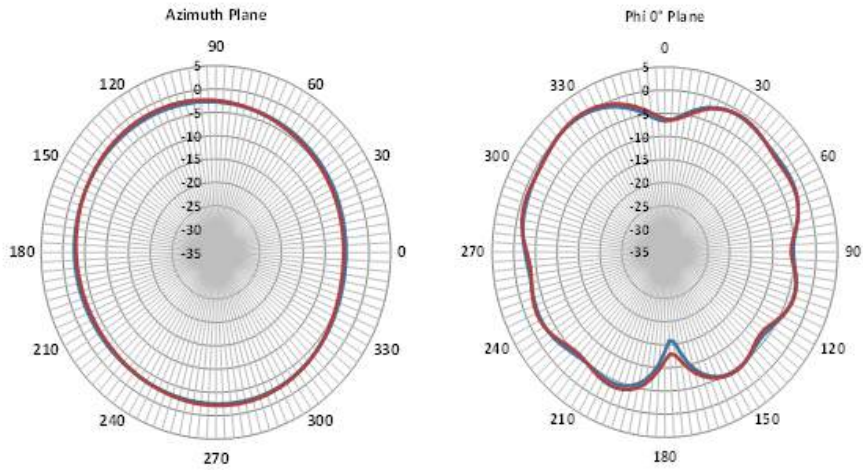

— On metal housing  
— On plastic housing with ground plane kit

**Radiation Pattern at 960 MHz**

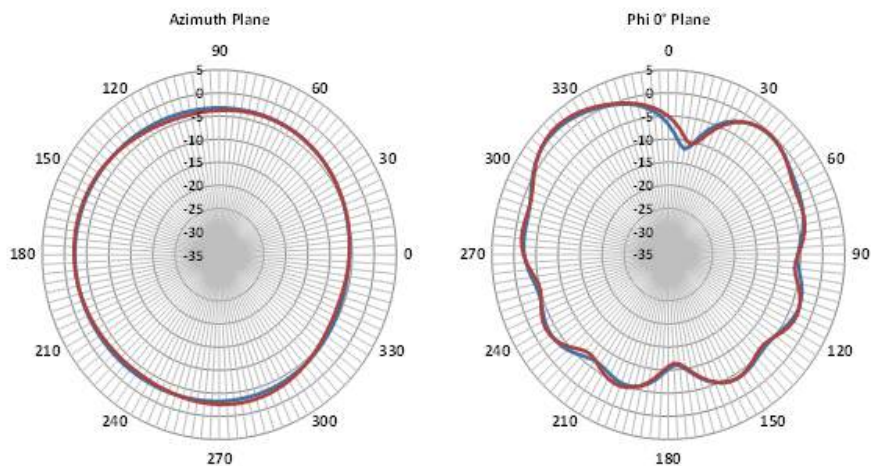

**Radiation Pattern at 1710 MHz**

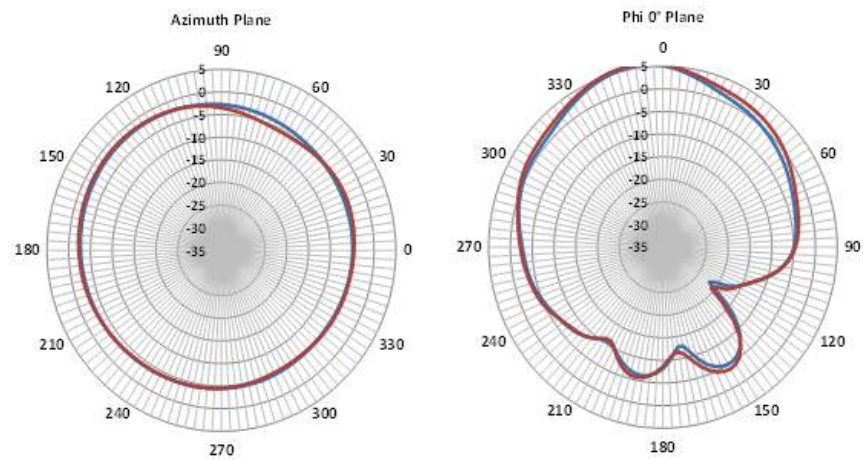

— On metal housing  
— On plastic housing with ground plane kit

**Radiation Pattern at 1950 MHz**

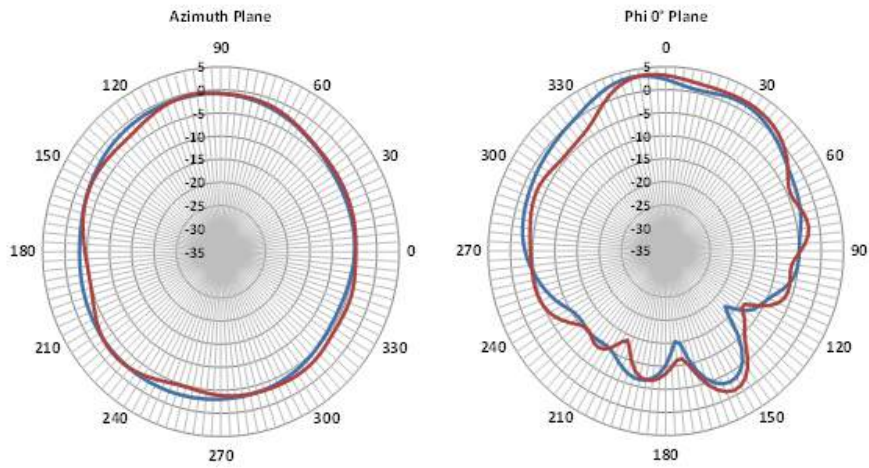

**Radiation Pattern at 2170 MHz**

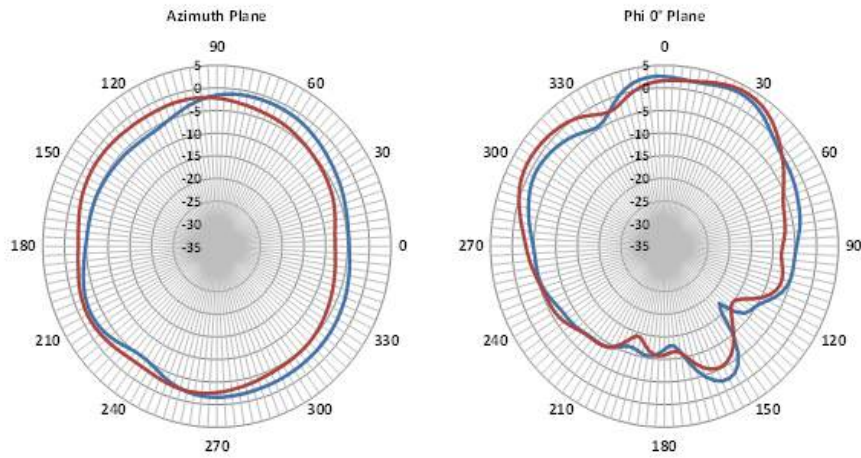

— On metal housing  
— On plastic housing with ground plane kit

**Radiation Pattern at 2700 MHz**

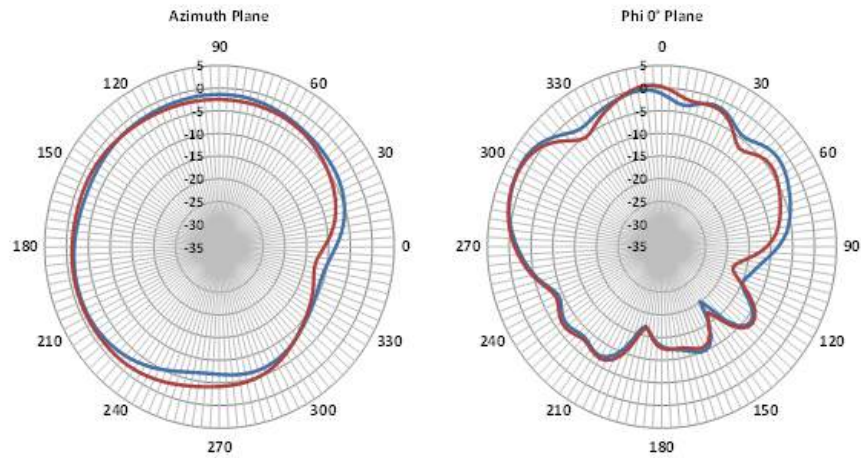

**HOUSING CONFIGURATIONS**

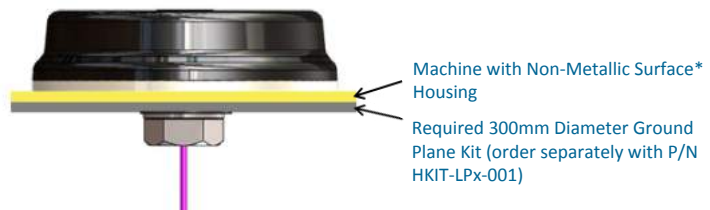
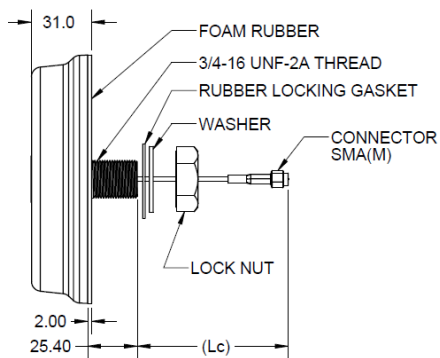

Americas: +1.847.839.6907  
IAS-AmericasEastSales@lairdtech.com

Europe: +44.1628.858941  
IAS-EUSales@lairdtech.com

Asia: +86.21.5855.0827.127 IAS-  
AsiaSales@lairdtech.com

[www.lairdtech.com](http://www.lairdtech.com)

ANT-DS-LPS69273NT\_0815

Any information furnished by Laird Inc. and its agents is believed to be accurate and reliable. All specifications are subject to change without notice. Responsibility for the use and application of Laird materials rests with the end user, since Laird and its agents cannot be aware of all potential uses. Laird makes no warranties as to the fitness, merchantability or suitability of any Laird materials or products for any specific or general uses. Laird shall not be liable for incidental or consequential damages of any kind. All Laird products are sold pursuant to the Laird Terms and Conditions of sale in effect from time to time, a copy of which will be furnished upon request. © Copyright 2015 Laird Inc. All Rights Reserved. Laird, Laird Technologies, the Laird Logo, and other marks are trade marks or registered trade marks of Laird Inc. or an affiliate company thereof. Other product or service names may be the property of third parties. Nothing herein provides a license under any Laird or any third party intellectual property rights.