



Chipsmall Limited consists of a professional team with an average of over 10 year of expertise in the distribution of electronic components. Based in Hongkong, we have already established firm and mutual-benefit business relationships with customers from,Europe,America and south Asia,supplying obsolete and hard-to-find components to meet their specific needs.

With the principle of “Quality Parts,Customers Priority,Honest Operation,and Considerate Service”,our business mainly focus on the distribution of electronic components. Line cards we deal with include Microchip,ALPS,ROHM,Xilinx,Pulse,ON,Everlight and Freescale. Main products comprise IC,Modules,Potentiometer,IC Socket,Relay,Connector.Our parts cover such applications as commercial,industrial, and automotives areas.

We are looking forward to setting up business relationship with you and hope to provide you with the best service and solution. Let us make a better world for our industry!



## Contact us

Tel: +86-755-8981 8866 Fax: +86-755-8427 6832

Email & Skype: info@chipsmall.com Web: www.chipsmall.com

Address: A1208, Overseas Decoration Building, #122 Zhenhua RD., Futian, Shenzhen, China



**CHIP COIL (CHIP INDUCTORS) LQM21NN□□□□10□ REFERENCE SPECIFICATION****1. Scope**

This reference specification applies to LQM21NN\_10 series, Chip coil (Chip Inductors).

**2. Part Numbering**

(ex)   LQ     M     21     N     N     R10     K     1     0     D    
 Product ID Structure Dimension Applications Category Inductance Tolerance Features Electrode Packaging  
 (L×W) and Characteristics  
 \*B: Bulk packing also available

D: Taping (Paper tape)  
L: Taping (Plastic tape)  
\*B: Bulk

**3. Rating**

- Operating Temperature Range      − 40°C to + 85°C
- Storage Temperature Range       − 55°C to +125°C

Customer Part Number	MURATA Part Number	Inductance		Q (min.)	DC Resistance (Ω max.)	Self Resonant Frequency (MHz min.)	Rated Current (mA)
		(μH)	Tolerance				
	LQM21NNR10K10D	0.10	±10%	20	0.26	340	250
	LQM21NNR12K10D	0.12			0.29	310	
	LQM21NNR15K10D	0.15			0.32	270	
	LQM21NNR18K10D	0.18			0.35	250	
	LQM21NNR22K10D	0.22			0.38	220	
	LQM21NNR27K10D	0.27			0.42	200	
	LQM21NNR33K10D	0.33			0.48	180	
	LQM21NNR39K10D	0.39			0.53	165	
	LQM21NNR47K10D	0.47		0.57	150		
	LQM21NNR56K10D	0.56		0.63	140	150	
	LQM21NNR68K10D	0.68		0.72	125		
	LQM21NNR82K10D	0.82		0.81	115		
	LQM21NN1R0K10D	1.0		0.40	107	50	
	LQM21NN1R2K10D	1.2		0.47	97		
	LQM21NN1R5K10D	1.5		0.50	87		
	LQM21NN1R8K10D	1.8		0.57	80		
	LQM21NN2R2K10D	2.2		0.63	71	30	
	LQM21NN2R7K10L	2.7		0.69	66		
	LQM21NN3R3K10L	3.3		0.80	59		
	LQM21NN3R9K10L	3.9		0.89	53		
	LQM21NN4R7K10L	4.7	1.00	47			

**4. Testing Conditions**

《Unless otherwise specified》

Temperature : Ordinary Temperature / 15°C to 35°C  
 Humidity : Ordinary Humidity / 25%(RH) to 85%(RH)

《In case of doubt》

Temperature : 20°C± 2°C  
 Humidity : 60%(RH) to 70%(RH)  
 Atmospheric Pressure : 86kPa to 106kPa

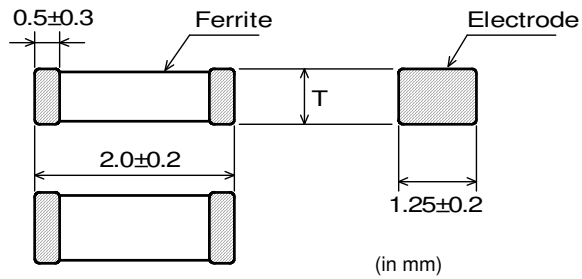
**5. Appearance and Dimensions**

Dimension of T	Inductance: 0.10 $\mu$ H to 2.2 $\mu$ H	0.85mm $\pm$ 0.2mm
	Inductance: 2.7 $\mu$ H to 4.7 $\mu$ H	1.25mm $\pm$ 0.2mm

Unit Mass (Typical value)	Inductance: 0.10 $\mu$ H to 2.2 $\mu$ H	0.010g
	Inductance: 2.7 $\mu$ H to 4.7 $\mu$ H	0.014g

**6. Electrical Performance**

No.	Item	Specification	Test Method
6.1	Inductance	Inductance shall meet item 3.	Measuring Equipment: Agilent 4291A or equivalent (1mA) Measuring Frequency: 25MHz/ 0.1 $\mu$ H to 0.82 $\mu$ H 10MHz/ 1.0 $\mu$ H to 4.7 $\mu$ H
6.2	Q	Q shall meet item 3.	
6.3	DC Resistance	DC Resistance shall meet item 3.	Measuring Equipment: Digital multi meter
6.4	Self Resonant Frequency (S.R.F)	S.R.F shall meet item 3.	Measuring Equipment: Agilent 4195A or equivalent (1mA)
6.5	Rated Current	Self temperature rise shall be limited to 25°C max. Inductance Change: within $\pm_5^0$ %	The rated current is applied.

**7. Mechanical Performance**

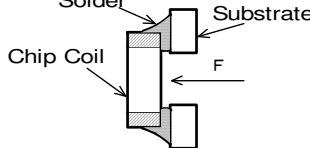
No.	Item	Specification	Test Method
7.1	Shear Test	Chip coil shall not be damaged after tested as test method.	Applied Direction:  Force: 10N Hold Duration: 5s $\pm$ 1s

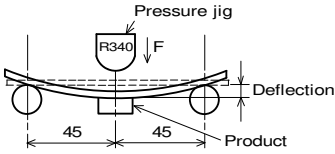
No.	Item	Specification	Test Method
7.2	Bending Test	Chip coil shall not be damaged after tested as test method.	Substrate: Glass-epoxy substrate (100mm×40mm×1.6mm)  Speed of Applying Force: 1mm/ s Deflection: 2mm Hold Duration: 30s (in mm)
7.3	Vibration	Appearance: No damage Inductance Change: within $\pm 10\%$	Oscillation Frequency: 10Hz to 55Hz to 10Hz for 1min Total Amplitude: 1.5mm Testing Time: A period of 2 h in each of 3 mutually Perpendicular directions.
7.4	Solderability	The wetting area of the electrode shall be at least 90% covered with new solder coating.	Flux: Ethanol solution of rosin 25(wt)% (Immersed for 5s to 10s) Solder: Sn-3.0Ag-0.5Cu Pre-Heating: $150^{\circ}\text{C} \pm 10^{\circ}\text{C}/60\text{s}$ to $90\text{s}$ Solder Temperature: $240^{\circ}\text{C} \pm 5^{\circ}\text{C}$ Immersion Time: $3\text{s} \pm 1\text{s}$
7.5	Resistance to Soldering Heat	Appearance: No damage Inductance Change: within $\pm 10\%$	Flux: Ethanol solution of rosin 25(wt)% (Immersed for 5s to 10s) Solder: Sn-3.0Ag-0.5Cu Pre-Heating: $150^{\circ}\text{C} \pm 10^{\circ}\text{C}/60\text{s}$ to $90\text{s}$ Solder Temperature: $270^{\circ}\text{C} \pm 5^{\circ}\text{C}$ Immersion Time: $10\text{s} \pm 1\text{s}$ Then measured after exposure in the room condition for $24\text{h} \pm 2\text{h}$ .

## 8. Environmental Performance

It shall be soldered on the substrate.

No.	Item	Specification	Test Method
8.1	Heat Resistance	Appearance: No damage Inductance Change: within $\pm 10\%$ Q Change: within $\pm 20\%$	Temperature: $85^{\circ}\text{C} \pm 2^{\circ}\text{C}$ Time: 1000 h (+48h, -0h) Then measured after exposure in the room condition for $48\text{h} \pm 2\text{h}$ .
8.2	Cold Resistance		Temperature: $-40^{\circ}\text{C} \pm 2^{\circ}\text{C}$ Time: 1000 h (+48h, -0h) Then measured after exposure in the room condition for $48\text{h} \pm 2\text{h}$ .
8.3	Humidity		Temperature: $40^{\circ}\text{C} \pm 2^{\circ}\text{C}$ Humidity: 90%(RH) to 95%(RH) Time: 1000 h (+48h, -0h) Then measured after exposure in the room condition for $48\text{h} \pm 2\text{h}$ .
8.4	Temperature Cycle		1 cycle: 1 step: $-40^{\circ}\text{C} \pm 2^{\circ}\text{C}/30\text{min} \pm 3\text{min}$ 2 step: Ordinary temp./ 10 min to 15 min 3 step: $+85^{\circ}\text{C} \pm 2^{\circ}\text{C}/30\text{min} \pm 3\text{min}$ 4 step: Ordinary temp./ 10 min to 15 min Total of 10 cycles Then measured after exposure in the room condition for $48\text{h} \pm 2\text{h}$ .

**9. Specification of Packaging**

**9.1 Appearance and Dimensions of paper tape,plastic tape (8mm-wide)**

P/N	Type	Dimensions (in mm)
LQM21NN R10K10D to 2R2K10D	8mm-wide Paper tape	
LQM21NN 2R7K10L 3R3K10L 3R9K10L 4R7K10L	8mm-wide Plastic tape	<p style="text-align: center;">*Dimension of the Cavity is measured at the bottom side.</p>

**9.2 Specification of Taping**

- (1) Packing quantity (standard quantity)
  - Inductance : 0.10μH to 2.2μH (Paper tape)    4,000 pcs./ reel
  - Inductance : 2.7μH to 4.7 μH (Plastic tape)    3,000 pcs./ reel
- (2) Packing Method
  - (Paper tape)  
Products shall be packed in the cavity of the base tape and sealed by top tape and bottom tape.
  - (Plastic tape)  
Products shall be packed in the each embossed cavity of plastic tape and sealed by cover tape.
- (3) Sprocket hole  
The sprocket holes are to the right as the tape is pulled toward the user.
- (4) Spliced point
  - (Paper tape)  
Base tape and Top tape has no spliced point.
  - (Plastic tape)  
Plastic tape and Cover tape has no spliced point.
- (5) Missing components number  
Missing components number within 0.1% of the number per reel or 1 pc., whichever is greater, and are not continuous. The Specified quantity per reel is kept.

**9.3 Pull Strength**

**【Case of Paper tape】**

Top tape	5N min.
Bottom tape	

**【Case of Plastic tape】**

Plastic tape	10N min.
Cover tape	5N min.

### 9.4 Peeling off force

【Case of Paper tape】

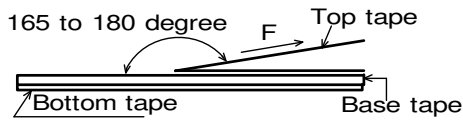

【Case of Plastic tape】

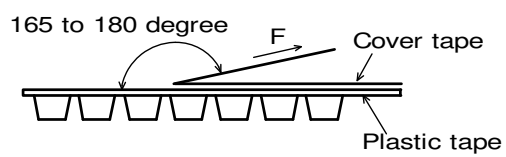

Speed of Peeling off	300mm/ min
Peeling off force	Paper tape: 0.1N to 0.6N Plastic tape: 0.2N to 0.7N (minimum value is typical)

### 9.5 Dimensions of Leader-tape, Trailer and Reel

There shall be leader-tape (top tape/cover tape and empty tape) and trailer-tape (empty tape) as follows.

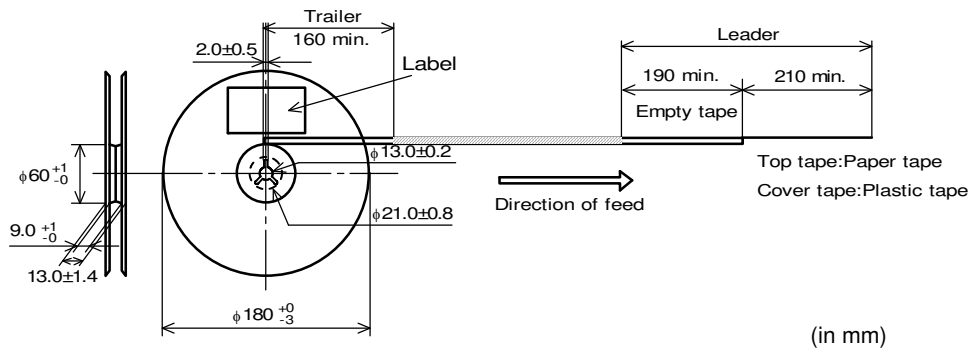

(in mm)

### 9.6 Marking for reel

Customer part number, MURATA part number, Inspection number (\*1), RoHS Marking (\*2), Quantity etc ...

\*1) <Expression of Inspection No.>

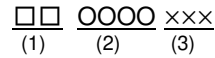

- (1) Factory Code
- (2) Date      First digit      : Year/ Last digit of year  
                  Second digit     : Month/ Jan. to Sep. → 1 to 9, Oct. to Dec. → O, N, D  
                  Third, Fourth digit : Day
- (3) Serial No.

\*2) <Expression of RoHS Marking >

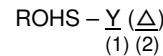

- (1) RoHS regulation conformity parts.
- (2) MURATA classification number

### 9.7 Marking for Outside package (corrugated paper box)

Customer name, Purchasing order number, Customer part number, MURATA part number, RoHS Marking (\*2), Quantity, etc ...

### 9.8. Specification of Outer Case

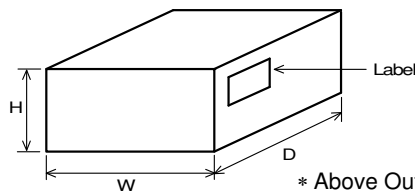

Outer Case Dimensions (mm)			Standard Reel Quantity in Outer Case (Reel)
W	D	H	
186	186	93	5

\* Above Outer Case size is typical. It depends on a quantity of an order.

**10. ⚠ Caution**

**Limitation of Applications**

Please contact us before using our products for the applications listed below which require especially high reliability for the prevention of defects which might directly cause damage to the third party's life, body or property.

- |                                   |  |
|-----------------------------------|--|
| (1) Aircraft equipment            | (6) Transportation equipment (vehicles, trains, ships, etc.)   |
| (2) Aerospace equipment           | (7) Traffic signal equipment   |
| (3) Undersea equipment            | (8) Disaster prevention / crime prevention equipment   |
| (4) Power plant control equipment | (9) Data-processing equipment  |
| (5) Medical equipment             | (10) Applications of similar complexity and /or reliability requirements to the applications listed in the above |

**11. Notice**

This product is designed for solder mounting.  
Please consult us in advance for applying other mounting method such as conductive adhesive.

**11.1 Land pattern designing**

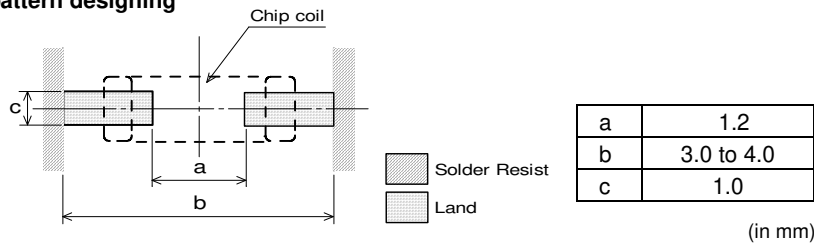

**11.2 Flux, Solder**

- Use rosin-based flux.  
Don't use highly acidic flux with halide content exceeding 0.2(wt) % (chlorine conversion value).  
Don't use water-soluble flux.
- Use Sn-3.0Ag-0.5Cu solder.
- Standard thickness of solder paste: 100μm to 150μm.

**11.3 Flow soldering/ Reflow soldering conditions**

- Pre-heating should be in such a way that the temperature difference between solder and product surface is limited to 150°C max. Cooling into solvent after soldering also should be in such a way that the temperature difference is limited to 100°C max.  
Insufficient pre-heating may cause cracks on the product, resulting in the deterioration of products quality.
- Standard soldering profile and the limit soldering profile is as follows.  
The excessive limit soldering conditions may cause leaching of the electrode and/or resulting in the deterioration of product quality.

Soldering profile

(1) Flow soldering profile

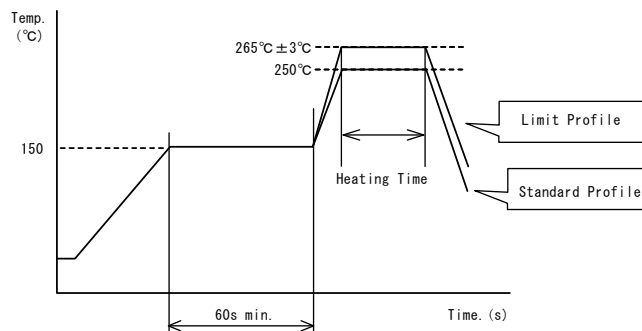

	Standard Profile	Limit Profile
Pre-heating	150°C, 60s min.	
Heating	250°C, 4s~6s	265°C±3°C, 5s
Cycle of flow	2 times	2 times

(2) Reflow soldering profile

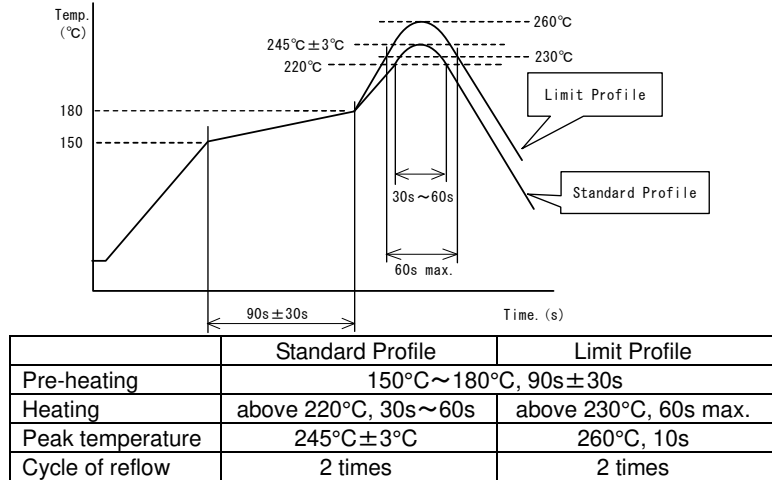

**11.4 Reworking with soldering iron.**

The following conditions must be strictly followed when using a soldering iron.

Pre-heating	150°C, 1 min
Tip temperature	350°C max.
Soldering iron output	80W max.
Tip diameter	φ 3mm max.
Soldering time	3(+1,-0)s
Time	2 times

Note : Do not directly touch the products with the tip of the soldering iron in order to prevent the crack on the products due to the thermal shock.

**11.5 Solder Volume**

- Solder shall be used not to be exceeded the upper limits as shown below.
- Accordingly increasing the solder volume, the mechanical stress to Chip is also increased. Exceeding solder volume may cause the failure of mechanical or electrical performance.

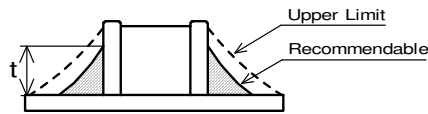

$$1/3T \leq t \leq T$$

T : thickness of product

**11.6 Product's location**

The following shall be considered when designing and laying out P.C.B.'s.

- (1) P.C.B. shall be designed so that products are not subject to the mechanical stress due to warping the board.

[Products direction]

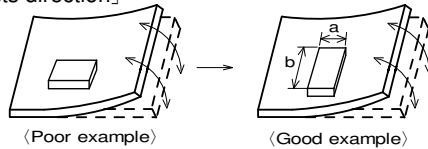

Products shall be located in the sideways direction (Length: a < b) to the mechanical stress.

- (2) Products location on P.C.B. separation

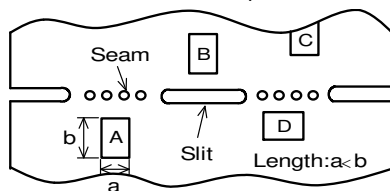

Products (A, B, C, D) shall be located carefully so that products are not subject to the mechanical stress due to warping the board. Because they may be subjected the mechanical stress in order of A > C > B ≅ D.



**11.7 Cleaning Conditions**

Products shall be cleaned on the following conditions.

- (1) Cleaning temperature shall be limited to 60°C max. (40°C max for IPA.)
- (2) Ultrasonic cleaning shall comply with the following conditions with avoiding the resonance phenomenon at the mounted products and P.C.B.  
Power : 20 W/ l max.      Frequency : 28kHz to 40kHz      Time : 5 min max.
- (3) Cleaner
  1. Alcohol type cleaner  
Isopropyl alcohol (IPA)
  2. Aqueous agent  
PINE ALPHA ST-100S
- (4) There shall be no residual flux and residual cleaner after cleaning. In the case of using aqueous agent, products shall be dried completely after rinse with de-ionized water in order to remove the cleaner.
- (5) Other cleaning    Please contact us.

**11.8 Resin coating**

The inductance value may change and/or it may affect on the product's performance due to high cure-stress of resin to be used for coating / molding products. So please pay your careful attention when you select resin.

In prior to use, please make the reliability evaluation with the product mounted in your application set.

**11.9 Caution for use**

There is possibility that the inductance value change due to magnetism. Don't use a magnet or a pair of tweezers with magnetism when chip coil are handled. (The tip of the tweezers should be molded with resin or pottery.)

**11.10 Magnetic Saturation**

When the excessive current over rated current is applied, the inductance value may change due to magnetism.

**11.11 Handling of a substrate**

After mounting products on a substrate, do not apply any stress to the product caused by bending or twisting to the substrate when cropping the substrate, inserting and removing a connector from the substrate or tightening screw to the substrate.

Excessive mechanical stress may cause cracking in the product.

Bending

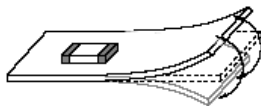

Twisting

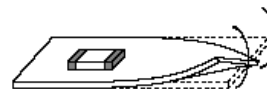

**11.12 Storage and Handling Requirements**

## (1) Storage period

Use the products within 6 months after delivered.  
Solderability should be checked if this period is exceeded.

## (2) Storage conditions

- Products should be stored in the warehouse on the following conditions.  
Temperature : -10°C to 40°C  
Humidity : 15% to 85% relative humidity No rapid change on temperature and humidity  
Don't keep products in corrosive gases such as sulfur, chlorine gas or acid, or it may cause oxidization of electrode, resulting in poor solderability.
- Products should be stored on the palette for the prevention of the influence from humidity, dust and so on.
  - Products should be stored in the warehouse without heat shock, vibration, direct sunlight and so on.
  - Products should be stored under the airtight packaged condition.

## (3) Handling Condition

Care should be taken when transporting or handling product to avoid excessive vibration or mechanical shock.

**12.  Note**

- (1) Please make sure that your product has been evaluated in view of your specifications with our product being mounted to your product.
- (2) You are requested not to use our product deviating from the reference specifications.
- (3) The contents of this reference specification are subject to change without advance notice.  
Please approve our product specifications or transact the approval sheet for product specifications before ordering.