



Chipsmall Limited consists of a professional team with an average of over 10 year of expertise in the distribution of electronic components. Based in Hongkong, we have already established firm and mutual-benefit business relationships with customers from,Europe,America and south Asia,supplying obsolete and hard-to-find components to meet their specific needs.

With the principle of “Quality Parts,Customers Priority,Honest Operation,and Considerate Service”,our business mainly focus on the distribution of electronic components. Line cards we deal with include Microchip,ALPS,ROHM,Xilinx,Pulse,ON,Everlight and Freescale. Main products comprise IC,Modules,Potentiometer,IC Socket,Relay,Connector.Our parts cover such applications as commercial,industrial, and automotives areas.

We are looking forward to setting up business relationship with you and hope to provide you with the best service and solution. Let us make a better world for our industry!



Contact us

Tel: +86-755-8981 8866 Fax: +86-755-8427 6832

Email & Skype: info@chipsmall.com Web: www.chipsmall.com

Address: A1208, Overseas Decoration Building, #122 Zhenhua RD., Futian, Shenzhen, China



CHIP COIL (CHIP INDUCTORS) LQW15AN□□□□80D Reference Specification

1.Scope

This Reference Specification applies to LQW15AN_80 series, Chip coil (Chip Inductors).

2.Part Numbering

(ex) $\frac{\text{LQ}}{\text{Product ID}}$ $\frac{\text{W}}{\text{Structure}}$ $\frac{15}{\text{Dimension (L} \times \text{W)}}$ $\frac{\text{A}}{\text{Applications and Characteristics}}$ $\frac{\text{N}}{\text{Category}}$ $\frac{1\text{N}3}{\text{Inductance}}$ $\frac{\text{C}}{\text{Tolerance}}$ $\frac{8}{\text{Features}}$ $\frac{0}{\text{Electrode}}$ $\frac{\text{D}}{\text{Packaging}}$
 *B: Bulk

* Bulk packing also available. (A product is put in the plastic bag under the taping conditions.)

3.Rating

- Operating Temperature Range. $-55^{\circ}\text{C} \sim +125^{\circ}\text{C}$
- Storage Temperature Range. $-55^{\circ}\text{C} \sim +125^{\circ}\text{C}$

Customer Part Number	MURATA Part Number	Inductance		Q (min.)	DC Resistance (Ω max.)	Self Resonant Frequency (GHz min.)	Rated Current (mA)		
		(nH)	Tolerance						
	LQW15AN1N3C80D	1.3	C: $\pm 0.2\text{nH}$ D: $\pm 0.5\text{nH}$	20	0.012	18.0	3150		
	LQW15AN1N3D80D								
	LQW15AN1N5C80D	1.5			0.028		20	0.045	2100
	LQW15AN1N5D80D								
	LQW15AN1N6C80D				1.6			0.065	
	LQW15AN1N6D80D								
	LQW15AN1N7C80D	1.7		0.065	20	0.065	1150		
	LQW15AN1N7D80D								
	LQW15AN2N2B80D	2.2		B: $\pm 0.1\text{nH}$ C: $\pm 0.2\text{nH}$ D: $\pm 0.5\text{nH}$ G: $\pm 2\%$	30	0.022	15.5	2530	
	LQW15AN2N2C80D								
	LQW15AN2N2D80D								
	LQW15AN2N2G80D								
	LQW15AN2N3B80D	2.3	0.022			30		0.022	2530
	LQW15AN2N3C80D								
	LQW15AN2N3D80D								
	LQW15AN2N3G80D								
	LQW15AN2N4B80D	2.4	0.030		30	0.030	2100		
	LQW15AN2N4C80D								
	LQW15AN2N4D80D								
	LQW15AN2N4G80D								
	LQW15AN2N5B80D	2.5	0.035		30	0.035	14.5		
	LQW15AN2N5C80D								
	LQW15AN2N5D80D								
	LQW15AN2N5G80D								
	LQW15AN2N6B80D	2.6	0.035	30	0.035	14.5			
	LQW15AN2N6C80D								
	LQW15AN2N6D80D								
	LQW15AN2N6G80D								
	LQW15AN2N7B80D	2.7	0.047	28	0.047	14.0			
	LQW15AN2N7C80D								
	LQW15AN2N7D80D								
	LQW15AN2N7G80D								
	LQW15AN2N8B80D	2.8	0.047	27	0.047	13.5			
	LQW15AN2N8C80D								
	LQW15AN2N8D80D								
	LQW15AN2N8G80D								
	LQW15AN2N9B80D	2.9	0.047	25	0.047	12.5			
	LQW15AN2N9C80D								
	LQW15AN2N9D80D								
	LQW15AN2N9G80D								

Customer Part Number	MURATA Part Number	Inductance		Q (min.)	DC Resistance (Ω max.)	Self Resonant Frequency (GHz min.)	Rated Current (mA)							
		(nH)	Tolerance											
	LQW15AN3N0B80D	3.0	B:±0.1nH C:±0.2nH D:±0.5nH G:±2%	20	0.063	12.5	1350							
	LQW15AN3N0C80D													
	LQW15AN3N0D80D													
	LQW15AN3N0G80D	3.3		B:±0.1nH C:±0.2nH D:±0.5nH G:±2%	30	0.030	14.0	2000						
	LQW15AN3N3B80D													
	LQW15AN3N3C80D													
	LQW15AN3N3D80D													
	LQW15AN3N3G80D	3.4			B:±0.1nH C:±0.2nH D:±0.5nH G:±2%	30	0.030	10.0	1950					
	LQW15AN3N4B80D													
	LQW15AN3N4C80D													
	LQW15AN3N4D80D													
	LQW15AN3N4G80D	3.5				B:±0.1nH C:±0.2nH D:±0.5nH G:±2%	30	0.030	10.0	1950				
	LQW15AN3N5B80D													
	LQW15AN3N5C80D													
	LQW15AN3N5D80D													
	LQW15AN3N5G80D	3.6					B:±0.1nH C:±0.2nH D:±0.5nH G:±2%	35	0.030	10.0	1950			
	LQW15AN3N6B80D													
	LQW15AN3N6C80D													
	LQW15AN3N6D80D													
	LQW15AN3N6G80D	3.7						B:±0.1nH C:±0.2nH D:±0.5nH G:±2%	35	0.030	10.0	1950		
	LQW15AN3N7B80D													
	LQW15AN3N7C80D													
	LQW15AN3N7D80D													
	LQW15AN3N7G80D	3.8							B:±0.1nH C:±0.2nH D:±0.5nH G:±2%	35	0.030	10.0	1950	
	LQW15AN3N8B80D													
	LQW15AN3N8C80D													
	LQW15AN3N8D80D													
	LQW15AN3N8G80D	3.9								B:±0.1nH C:±0.2nH D:±0.5nH G:±2%	35	0.030	10.0	1950
	LQW15AN3N9B80D													
	LQW15AN3N9C80D													
	LQW15AN3N9D80D													
	LQW15AN3N9G80D	4.0	B:±0.1nH C:±0.2nH D:±0.5nH G:±2%								30	0.044	9.6	1800
	LQW15AN4N0B80D													
	LQW15AN4N0C80D													
	LQW15AN4N0D80D													
	LQW15AN4N0G80D	4.1		B:±0.1nH C:±0.2nH D:±0.5nH G:±2%							30	0.044	9.6	1800
	LQW15AN4N1B80D													
	LQW15AN4N1C80D													
	LQW15AN4N1D80D													
	LQW15AN4N1G80D	4.2			B:±0.1nH C:±0.2nH D:±0.5nH G:±2%						30	0.044	9.6	1800
	LQW15AN4N2B80D													
	LQW15AN4N2C80D													
	LQW15AN4N2D80D													
	LQW15AN4N2G80D	4.3				B:±0.1nH C:±0.2nH D:±0.5nH G:±2%					32	0.052	1600	1600
	LQW15AN4N3B80D													
	LQW15AN4N3C80D													
	LQW15AN4N3D80D													
	LQW15AN4N3G80D	4.4					B:±0.1nH C:±0.2nH D:±0.5nH G:±2%				34	0.052	1600	1600
	LQW15AN4N4B80D													
	LQW15AN4N4C80D													
	LQW15AN4N4D80D													
	LQW15AN4N4G80D													

Customer Part Number	MURATA Part Number	Inductance		Q (min.)	DC Resistance (Ω max.)	Self Resonant Frequency (GHz min.)	Rated Current (mA)
		(nH)	Tolerance				
	LQW15AN4N5B80D	4.5		34	0.060	9.6	1450
	LQW15AN4N5C80D						
	LQW15AN4N5D80D						
	LQW15AN4N5G80D						
	LQW15AN4N6B80D	4.6		32			
	LQW15AN4N6C80D						
	LQW15AN4N6D80D						
	LQW15AN4N6G80D						
	LQW15AN4N7B80D	4.7		31			
	LQW15AN4N7C80D						
	LQW15AN4N7D80D						
	LQW15AN4N7G80D						
	LQW15AN4N8B80D	4.8		30	0.071	8.0	1200
	LQW15AN4N8C80D						
	LQW15AN4N8D80D						
	LQW15AN4N8G80D						
	LQW15AN4N9B80D	4.9		27			
	LQW15AN4N9C80D						
	LQW15AN4N9D80D						
	LQW15AN4N9G80D						
	LQW15AN5N0B80D	5.0		32		10.0	
	LQW15AN5N0C80D						
	LQW15AN5N0D80D						
	LQW15AN5N0G80D						
	LQW15AN5N1B80D	5.1	B: \pm 0.1nH C: \pm 0.2nH D: \pm 0.5nH G: \pm 2%				
	LQW15AN5N1C80D						
	LQW15AN5N1D80D						
	LQW15AN5N1G80D						
	LQW15AN5N2B80D	5.2					
	LQW15AN5N2C80D						
	LQW15AN5N2D80D						
	LQW15AN5N2G80D						
	LQW15AN5N3B80D	5.3		35			
	LQW15AN5N3C80D						
	LQW15AN5N3D80D						
	LQW15AN5N3G80D						
	LQW15AN5N4B80D	5.4			0.040	8.0	1770
	LQW15AN5N4C80D						
	LQW15AN5N4D80D						
	LQW15AN5N4G80D						
	LQW15AN5N5B80D	5.5					
	LQW15AN5N5C80D						
	LQW15AN5N5D80D						
	LQW15AN5N5G80D						
	LQW15AN5N6B80D	5.6					
	LQW15AN5N6C80D						
	LQW15AN5N6D80D						
	LQW15AN5N6G80D						
	LQW15AN5N7B80D	5.7		30			
	LQW15AN5N7C80D						
	LQW15AN5N7D80D						
	LQW15AN5N7G80D						
	LQW15AN5N8B80D	5.8					
	LQW15AN5N8C80D						
	LQW15AN5N8D80D						
	LQW15AN5N8G80D						

Customer Part Number	MURATA Part Number	Inductance		Q (min.)	DC Resistance (Ω max.)	Self Resonant Frequency (GHz min.)	Rated Current (mA)							
		(nH)	Tolerance											
	LQW15AN5N9B80D	5.9	B:±0.1nH C:±0.2nH D:±0.5nH G:±2%	30	0.040	8.0	1770							
	LQW15AN5N9C80D													
	LQW15AN5N9D80D													
	LQW15AN5N9G80D													
	LQW15AN6N0B80D	6.0		B:±0.1nH C:±0.2nH D:±0.5nH G:±2%	32	0.056	8.0	1600						
	LQW15AN6N0C80D													
	LQW15AN6N0D80D													
	LQW15AN6N0G80D													
	LQW15AN6N1B80D	6.1			B:±0.1nH C:±0.2nH D:±0.5nH G:±2%	32	0.056	8.0	1600					
	LQW15AN6N1C80D													
	LQW15AN6N1D80D													
	LQW15AN6N1G80D													
	LQW15AN6N2B80D	6.2	B:±0.1nH C:±0.2nH D:±0.5nH G:±2%			33	0.056	8.0	1600					
	LQW15AN6N2C80D													
	LQW15AN6N2D80D													
	LQW15AN6N2G80D													
	LQW15AN6N3G80D	6.3		B:±0.1nH C:±0.2nH D:±0.5nH G:±2%		32	0.057	7.8	1600					
	LQW15AN6N3J80D													
	LQW15AN6N4G80D									6.4	33	0.065	7.0	1380
	LQW15AN6N4J80D													
	LQW15AN6N5G80D	6.5			32	0.078	7.0	1280						
	LQW15AN6N5J80D													
	LQW15AN6N6G80D								6.6	30	0.068	7.0	1450	
	LQW15AN6N6J80D													
	LQW15AN6N7G80D	6.7	32		0.069	8.0	1420							
	LQW15AN6N7J80D													
	LQW15AN6N8G80D							6.8	33	0.069	8.0	1420		
	LQW15AN6N8J80D													
	LQW15AN6N9G80D	6.9	32	0.069	8.0	1420								
	LQW15AN6N9J80D													
	LQW15AN7N0G80D						7.0	33	0.069	8.0	1420			
	LQW15AN7N0J80D													
	LQW15AN7N1G80D	7.1	32	0.050	7.0	1700								
	LQW15AN7N1J80D													
	LQW15AN7N2G80D						7.2	30	0.050	7.0	1700			
	LQW15AN7N2J80D													
	LQW15AN7N3G80D	7.3	35	0.050	7.0	1700								
	LQW15AN7N3J80D													
	LQW15AN7N4G80D						7.4	30	0.050	7.0	1700			
	LQW15AN7N4J80D													
	LQW15AN7N5G80D	7.5	35	0.050	7.0	1700								
	LQW15AN7N5J80D													
	LQW15AN7N6G80D						7.6	30	0.050	7.0	1700			
	LQW15AN7N6J80D													
	LQW15AN7N7G80D	7.7	30	0.050	7.0	1700								
	LQW15AN7N7J80D													
	LQW15AN7N8G80D						7.8	30	0.050	7.0	1700			
	LQW15AN7N8J80D													
	LQW15AN7N9G80D	7.9	30	0.050	7.0	1700								
	LQW15AN7N9J80D													
	LQW15AN8N0G80D						8.0	30	0.050	7.0	1700			
	LQW15AN8N0J80D													
	LQW15AN8N1G80D	8.1	32	0.069	6.5	1500								
	LQW15AN8N1J80D													
	LQW15AN8N2G80D						8.2	32	0.069	6.5	1500			
	LQW15AN8N2J80D													

Customer Part Number	MURATA Part Number	Inductance		Q (min.)	DC Resistance (Ω max.)	Self Resonant Frequency (GHz min.)	Rated Current (mA)
		(nH)	Tolerance				
	LQW15AN8N3G80D	8.3	G:±2% J:±5%	32	0.069	6.5	1500
	LQW15AN8N3J80D						
	LQW15AN8N4G80D						
	LQW15AN8N4J80D						
	LQW15AN8N5G80D	8.5		31	0.070	6.5	1420
	LQW15AN8N5J80D						
	LQW15AN8N6G80D						
	LQW15AN8N6J80D						
	LQW15AN8N7G80D	8.7		30	0.080	6.0	1400
	LQW15AN8N7J80D						
	LQW15AN8N8G80D						
	LQW15AN8N8J80D						
	LQW15AN8N9G80D	8.9		32	0.081	6.0	1400
	LQW15AN8N9J80D						
	LQW15AN9N0G80D						
	LQW15AN9N0J80D						
	LQW15AN9N1G80D	9.1		34	0.083	5.2	1240
	LQW15AN9N1J80D						
	LQW15AN9N2G80D						
	LQW15AN9N2J80D						
	LQW15AN9N3G80D	9.3	33	0.111	5.5	1150	
	LQW15AN9N3J80D						
	LQW15AN9N4G80D						
	LQW15AN9N4J80D						
	LQW15AN9N5G80D	9.5	32	0.126	5.0	1000	
	LQW15AN9N5J80D						
	LQW15AN9N6G80D						
	LQW15AN9N6J80D						
	LQW15AN9N7G80D	9.7	31	0.130	5.2	1050	
	LQW15AN9N7J80D						
	LQW15AN9N8G80D						
	LQW15AN9N8J80D						
	LQW15AN9N9G80D	9.9	30	0.156	5.0	920	
	LQW15AN9N9J80D						
	LQW15AN10NG80D						
	LQW15AN10NJ80D						
	LQW15AN11NG80D	11	30	0.093	5.2	1240	
	LQW15AN11NJ80D						
	LQW15AN12NG80D						
	LQW15AN12NJ80D						
	LQW15AN13NG80D	13	31	0.114	5.5	1150	
	LQW15AN13NJ80D						
	LQW15AN14NG80D						
	LQW15AN14NJ80D						
	LQW15AN15NG80D	15	30	0.126	5.0	1000	
	LQW15AN15NJ80D						
	LQW15AN16NG80D						
	LQW15AN16NJ80D						
	LQW15AN17NG80D	17	30	0.130	5.2	1050	
	LQW15AN17NJ80D						
	LQW15AN18NG80D						
	LQW15AN18NJ80D						
	LQW15AN19NG80D	19	30	0.156	5.0	920	
	LQW15AN19NJ80D						

Customer Part Number	MURATA Part Number	Inductance		Q (min.)	DC Resistance (Ω max.)	Self Resonant Frequency (GHz min.)	Rated Current (mA)
		(nH)	Tolerance				
	LQW15AN20NG80D	20	G:±2% J:±5%	30	0.186	4.5	800
	LQW15AN20NJ80D						
	LQW15AN21NG80D	21			0.202		780
	LQW15AN21NJ80D						
	LQW15AN22NG80D	22		29	0.201	760	
	LQW15AN22NJ80D						
	LQW15AN23NG80D	23		31	0.212	4.0	770
	LQW15AN23NJ80D						
	LQW15AN24NG80D	24		31	0.221	4.1	750
	LQW15AN24NJ80D						
	LQW15AN25NG80D	25		29	0.282	4.1	720
	LQW15AN25NJ80D						
	LQW15AN26NG80D	26		30	0.288	4.0	680
	LQW15AN26NJ80D						
	LQW15AN27NG80D	27		30	0.309	3.8	660
	LQW15AN27NJ80D						
	LQW15AN30NG80D	30		30	0.336	3.6	620
	LQW15AN30NJ80D						
	LQW15AN33NG80D	33		30	0.431	3.5	540
	LQW15AN33NJ80D						
	LQW15AN36NG80D	36	28	0.456	3.4	530	
	LQW15AN36NJ80D						
	LQW15AN39NG80D	39	30	0.516	3.4	515	
	LQW15AN39NJ80D						
	LQW15AN43NG80D	43	47	0.648	3.2	440	
	LQW15AN43NJ80D						
	LQW15AN47NG80D	47	51	0.696	2.9	415	
	LQW15AN47NJ80D						
	LQW15AN51NG80D	51	53	0.996	2.9	340	
	LQW15AN51NJ80D						
	LQW15AN53NG80D	53	68	1.128	2.5	320	
	LQW15AN53NJ80D						
	LQW15AN56NG80D	56	75	1.224	2.4	320	
	LQW15AN56NJ80D						
	LQW15AN68NG80D	68	75	1.224	2.4	320	
	LQW15AN68NJ80D						
	LQW15AN75NG80D	75	75	1.224	2.4	320	
	LQW15AN75NJ80D						

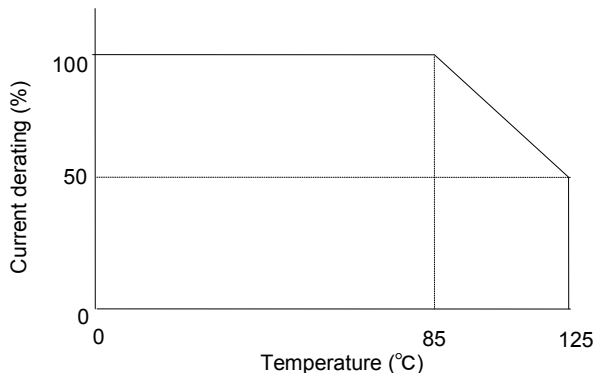

Derating of Rated Current depend on Operating Temperature

4. Testing Conditions

《Unless otherwise specified》

Temperature : Ordinary Temperature / 15°C to 35°C
 Humidity : Ordinary Humidity / 25%(RH) to 85%(RH)

《In case of doubt》

Temperature : 20°C±2°C
 Humidity : 60%(RH) to 70%(RH)
 Atmospheric Pressure : 86kPa to 106 kPa

5. Appearance and Dimensions

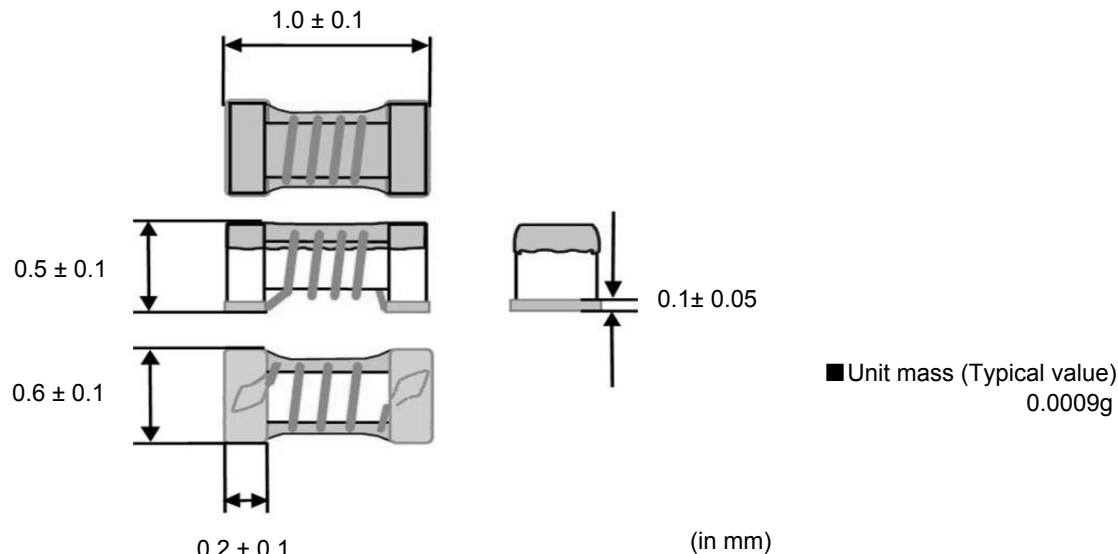

6. Electrical Performance

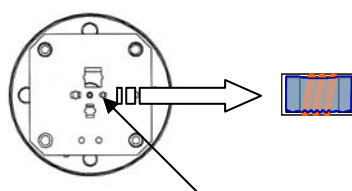
No.	Item	Specification	Test Method
6.1	Inductance	Inductance shall meet item 3.	Measuring Equipment: KEYSIGHT 4287A or equivalent Measuring Frequency: <Inductance> 100MHz <Q> 250MHz/1.3nH~43nH 200MHz/47nH~75nH Measuring Condition: Test signal level / about 0dBm Electrode spaces / 0.5mm Electrical length / 10mm Weight / about 1N~3N Measuring Fixture: KEYSIGHT 16197A
6.2	Q	Q shall meet item 3.	Position coil under test as shown in below and contact coil with each terminal by adding weight.  1005 Size Guide Measuring Method: See the endnote. <Electrical Performance: Measuring Method of Inductance/Q>
6.3	DC Resistance	DC Resistance shall meet item 3.	Measuring Equipment: Digital multi meter
6.4	Self Resonant Frequency(S.R.F)	S.R.F shall meet item 3.	Measuring Equipment: KEYSIGHT 8720C or equivalent
6.5	Rated Current	Self temperature rise shall be limited to 40°C max.	The rated current is applied.

7.Mechanical Performance

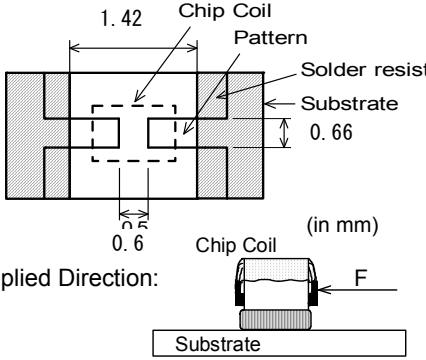
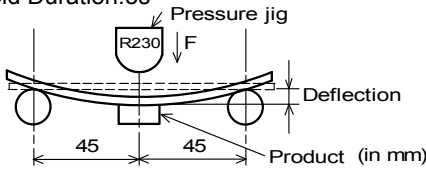
No.	Item	Specification	Test Method
7.1	Shear Test	Chip coil shall not be damaged after tested as test method.	<p>Substrate:Glass-epoxy substrate</p>  <p>Applied Direction:</p> <p>Force:5N Hold Duration:5s±1s</p>
7.2	Bending Test		<p>Substrate:Glass-epoxy substrate (100mm × 40mm × 0.8mm)</p> <p>Speed of Applying Force:1mm / s Deflection:2mm Hold Duration:5s</p> 
7.3	Vibration		<p>Oscillation Frequency: 10Hz~55Hz~10Hz for 1 min Total Amplitude:1.5mm Time : A period of 2 hours in each of 3 mutually perpendicular directions. (Total 6hours)</p>
7.4	Solderability	The wetting area of the electrode shall be at least 90% covered with new solder coating.	<p>Flux:Ethanol solution of rosin,25(wt)% Includes activator equivalent to 0.06(wt)% chlorine.(immersed for 5s to 10s) Solder:Sn-3.0Ag-0.5Cu Pre-Heating:150°C±10°C / 60s to 90s Solder Temperature:240°C±5°C Immersion Time:3s±1s</p>
7.5	Resistance to Soldering Heat	Appearance:No damage Inductance Change: within ±5%	<p>Flux:Ethanol solution of rosin,25(wt)% Includes activator equivalent to 0.06(wt)% Chlorine.(immersed for 5s to 10s) Solder:Sn-3.0Ag-0.5Cu Pre-Heating:150°C±10°C / 60s to 90s Solder Temperature:270°C±5°C Immersion Time:10s±1s Then measured after exposure in the room condition for 24h±2h.</p>

8.Environmental Performance

It shall be soldered on the substrate.

No.	Item	Specification	Test Method
8.1	Heat Resistance	Appearance:No damage Inductance Change: within $\pm 5\%$ Q Change: within $\pm 20\%$	Temperature: $125^{\circ}\text{C} \pm 2^{\circ}\text{C}$ Time: 1000h (+48h, 0h) Then measured after exposure in the room condition for $24\text{h} \pm 2\text{h}$.
8.2	Cold Resistance		Temperature: $-55^{\circ}\text{C} \pm 2^{\circ}\text{C}$ Time: 1000h (+48h, -0h) Then measured after exposure in the room condition for $24\text{h} \pm 2\text{h}$.
8.3	Humidity	Appearance:No damage Inductance Change: within $\pm 5\%$ Q Change: within $\pm 20\%$	Temperature: $70^{\circ}\text{C} \pm 2^{\circ}\text{C}$ Humidity: 90%(RH) to 95%(RH) Time: 1000h (+48h, -0h) Then measured after exposure in the room condition for $24\text{h} \pm 2\text{h}$.
8.4	Temperature Cycle		1 cycle: 1 step: $-55^{\circ}\text{C} \pm 2^{\circ}\text{C}$ / 30min ± 3 min 2 step: Ordinary temp. / 10min to 15 min 3 step: $+125^{\circ}\text{C} \pm 2^{\circ}\text{C}$ / 30min ± 3 min 4 step: Ordinary temp. / 10min to 15 min Total of 10 cycles Then measured after exposure in the room condition for $24\text{h} \pm 2\text{h}$.

9.Specification of Packaging

9.1 Appearance and Dimensions of paper tape (8mm-wide)

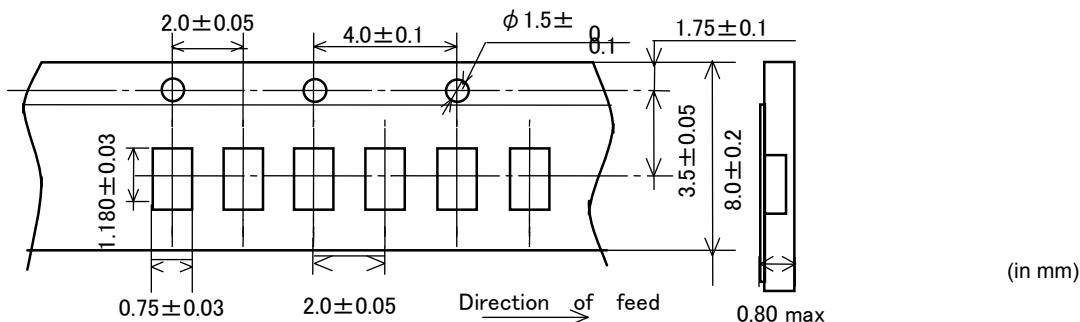

9.2 Specification of Taping

- (1) Packing quantity (standard quantity)
10,000 pcs. / reel
- (2) Packing Method
Products shall be packed in the cavity of the base tape and sealed by Cover tape.
- (3) Sprocket hole
The sprocket holes are to the right as the tape is pulled toward the user.
- (4) Spliced point
Base tape and Cover tape has no spliced point.
- (5) Missing components number
Missing components number within 0.1% of the number per reel or 1 pc., whichever is greater, and are not continuous. The Specified quantity per reel is kept.

9.3 Pull Strength

Cover tape	5N min.
------------	---------

9.4 Peeling off force of cover tape

Speed of Peeling off	300mm/min
Peeling off force	0.1 to 0.6N (minimum value is typical)

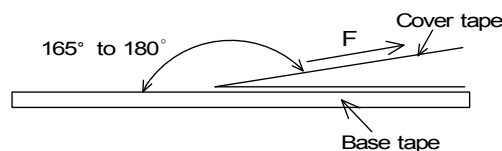

9.5 Dimensions of Leader-tape, Trailer and Reel

There shall be leader-tape (cover tape and empty tape) and trailer-tape (empty tape) as follows.

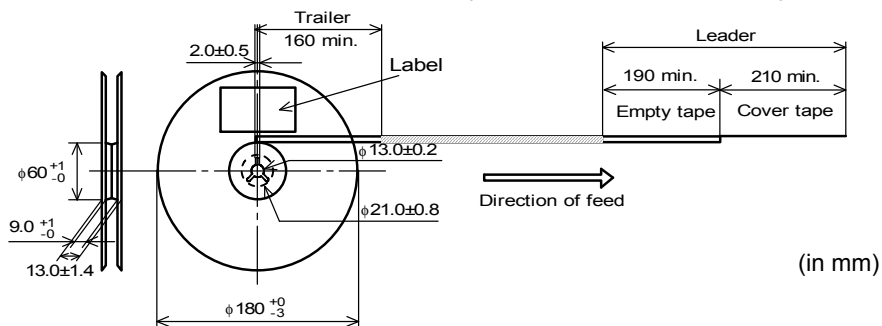

9.6 Marking for reel

Customer part number, MURATA part number, Inspection number(*1) ,RoHS Marking(*2), Quantity etc ...

*1) <Expression of Inspection No.>

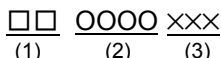

- (1) Factory Code
- (2) Date
 - First digit : Year / Last digit of year
 - Second digit : Month / Jan. to Sep. → 1 to 9, Oct. to Dec. → O, N, D
 - Third, Fourth digit : Day
- (3) Serial No.

*2) <Expression of RoHS Marking >

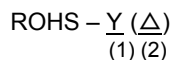

- (1) RoHS regulation conformity parts.
- (2) MURATA classification number

9.7 Marking for Outside package (corrugated paper box)

Customer name, Purchasing order number, Customer part number, MURATA part number, RoHS Marking (*2) ,Quantity, etc ...

9.8. Specification of Outer Case

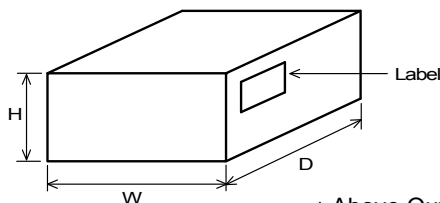

Outer Case Dimensions (mm)			Standard Reel Quantity in Outer Case (Reel)
W	D	H	
186	186	93	5

* Above Outer Case size is typical. It depends on a quantity of an order.

10. ⚠ Caution

Limitation of Applications

Please contact us before using our products for the applications listed below which require especially high reliability for the prevention of defects which might directly cause damage to the third party's life, body or property.

- (1) Aircraft equipment
- (2) Aerospace equipment
- (3) Undersea equipment
- (4) Power plant control equipment
- (5) Medical equipment
- (6) Transportation equipment (vehicles, trains, ships, etc.)
- (7) Traffic signal equipment
- (8) Disaster prevention / crime prevention equipment
- (9) Data-processing equipment
- (10) Applications of similar complexity and /or reliability requirements to the applications listed in the above

11. Notice

Products can only be soldered with reflow.
This product is designed for solder mounting.
Please consult us in advance for applying other mounting method such as conductive adhesive.

11.1 Land pattern designing

Recommended land patterns for reflow soldering are as follows:

These have been designed for Electric characteristics and solderability.

Please follow the recommended patterns. Otherwise, their performance which includes electrical performance or solderability may be affected, or result to "position shift" in soldering process.

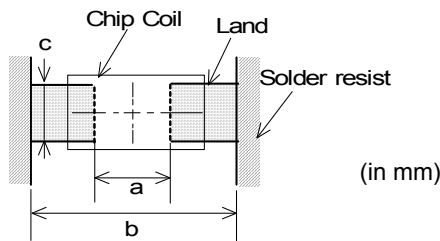

a	0.6
b	1.42
c	0.66

11.2 Flux, Solder

- Use rosin-based flux.

Includes middle activator equivalent to 0.06(wt)% to 0.1(wt) % Chlorine.

Don't use highly acidic flux with halide content exceeding 0.2(wt) % (chlorine conversion value).

Don't use water-soluble flux.

- Use Sn-3.0Ag-0.5Cu solder.

- Standard thickness of solder paste : 50 μm to 100 μm.

11.3 Reflow soldering conditions

- Pre-heating should be in such a way that the temperature difference between solder and product surface is limited to 150°C max. Cooling into solvent after soldering also should be in such a way that the temperature difference is limited to 100°C max.

Insufficient pre-heating may cause cracks on the product, resulting in the deterioration of products quality.

- Standard soldering profile and the limit soldering profile is as follows.

The excessive limit soldering conditions may cause leaching of the electrode and / or resulting in the deterioration of product quality.

- Reflow soldering profile

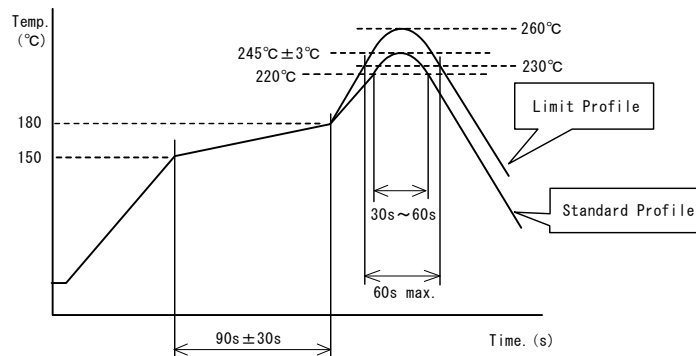

	Standard Profile	Limit Profile
Pre-heating	150°C ~ 180°C , 90s ± 30s	
Heating	above 220°C, 30s ~ 60s	above 230°C, 60s max.
Peak temperature	245°C ± 3°C	260°C, 10s
Cycle of reflow	2 times	

11.4 Solder Volume

- Solder shall be used not to be exceeded the upper limits as shown below.

- Accordingly increasing the solder volume, the mechanical stress to Chip is also increased.

Exceeding solder volume may cause the failure of mechanical or electrical performance.

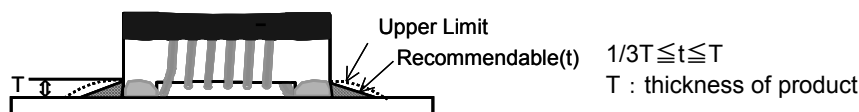

11.5 Product's location

The following shall be considered when designing and laying out P.C.B.'s.

- (1) P.C.B. shall be designed so that products are not subject to the mechanical stress due to warping the board.

[Products direction]

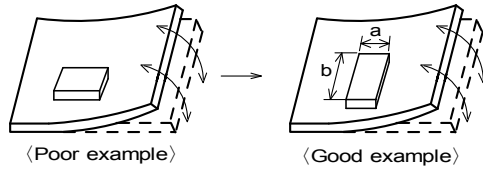

Products shall be located in the sideways direction (Length: $a < b$) to the mechanical stress.

- (2) Components location on P.C.B. separation.

It is effective to implement the following measures, to reduce stress in separating the board.

It is best to implement all of the following three measures; however, implement as many measures as possible to reduce stress.

Contents of Measures	Stress Level
(1) Turn the mounting direction of the component parallel to the board separation surface.	$A > D$ *1
(2) Add slits in the board separation part.	$A > B$
(3) Keep the mounting position of the component away from the board separation surface.	$A > C$

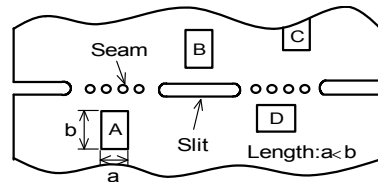

*1 $A > D$ is valid when stress is added vertically to the perforation as with Hand Separation.
If a Cutting Disc is used, stress will be diagonal to the PCB, therefore $A > D$ is invalid.

- (3) Mounting Components Near Screw Holes

When a component is mounted near a screw hole, it may be affected by the board deflection that occurs during the tightening of the screw. Mount the component in a position as far away from the screw holes as possible.

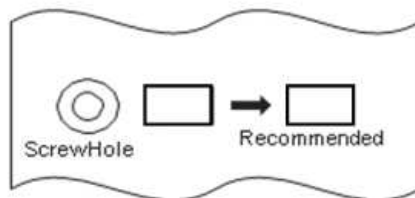

11.6 Cleaning Conditions

Products shall be cleaned on the following conditions.

- (1) Cleaning temperature shall be limited to 60°C max.(40°C max for IPA)
- (2) Ultrasonic cleaning shall comply with the following conditions with avoiding the resonance phenomenon at the mounted products and P.C.B.
Power : 20 W / l max. Frequency : 28kHz to 40kHz Time : 5 min max.
- (3) Cleaner
 1. Alcohol type cleaner
Isopropyl alcohol (IPA)
 2. Aqueous agent
PINE ALPHA ST-100S
- (4) There shall be no residual flux and residual cleaner after cleaning.
In the case of using aqueous agent, products shall be dried completely after rinse with de-ionized water in order to remove the cleaner.
- (5) Other cleaning Please contact us.

11.7 Resin coating

The inductance value may change due to high cure-stress of resin to be used for coating/molding products. An open circuit issue may occur by mechanical stress caused by the resin, amount/cured shape of resin, or operating condition etc. Some resin contains some impurities or chloride possible to generate chlorine by hydrolysis under some operating condition may cause corrosion of wire of coil, leading to open circuit. So, please pay your careful attention when you select resin in case of coating/molding the products with the resin. Prior to use the coating resin, please make sure no reliability issue is observed by evaluating products mounted on your board.

11.8 Caution for use

- Sharp material such as a pair of tweezers or other material such as bristles of cleaning brush , shall not be touched to the winding portion to prevent the breaking of wire.
- Mechanical shock should not be applied to the products mounted on the board to prevent the breaking of the core.

11.9 Notice of product handling at mounting

In some mounting machines,when picking up components support pin pushes up the components from the bottom of base tape. In this case, please remove the support pin. The support pin may damage the components and break wire.

In rare case ,the laser recognition can not recognize this component. Please contact us when you use laser recognition. (There is no problem with the permeation and reflection type.)

11.10 Handling of a substrate

After mounting products on a substrate, do not apply any stress to the product caused by bending or twisting to the substrate when cropping the substrate, inserting and removing a connector from the substrate or tightening screw to the substrate.

Excessive mechanical stress may cause cracking in the product.

Bending

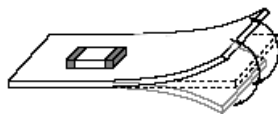

Twisting

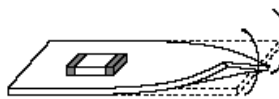
**11.11 Storage and Handling Requirements****(1) Storage period**

Use the products within 12 months after delivered.

Solderability should be checked if this period is exceeded.

(2) Storage conditions

• Products should be stored in the warehouse on the following conditions.

Temperature : -10°C to 40°C

Humidity : 15% to 85% relative humidity No rapid change on temperature and humidity

• Don't keep products in corrosive gases such as sulfur, chlorine gas or acid, or it may cause oxidization of electrode, resulting in poor solderability.

• Products should not be stored on bulk packaging condition to prevent the chipping of the core and the breaking of winding wire caused by the collision between the products.

• Products should be stored on the palette for the prevention of the influence from humidity, dust and so on.

• Products should be stored in the warehouse without heat shock, vibration, direct sunlight and so on.

(3) Handling Condition

Care should be taken when transporting or handling product to avoid excessive vibration or mechanical shock.

12. ⚠ Note

(1) Please make sure that your product has been evaluated in view of your specifications with our product being mounted to your product.

(2) You are requested not to use our product deviating from the reference specifications.

(3) The contents of this reference specification are subject to change without advance notice.

Please approve our product specifications or transact the approval sheet for product specifications before ordering.

<Electrical Performance:Measuring Method of Inductance/Q>

(1) Residual elements and stray elements of test fixture can be described by F-parameter shown in following.

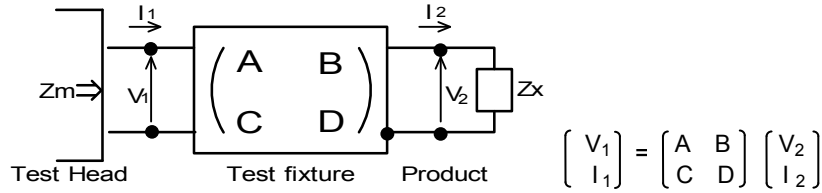

(2) The impedance of chip coil Zx and measured value Zm can be described by input/output current/voltage.

$$Z_m = \frac{V_1}{I_1} \quad , \quad Z_x = \frac{V_2}{I_2}$$

(3) Thus,the relation between Zx and Zm is following;

$$Z_x = \alpha \frac{Z_m - \beta}{1 - Z_m \Gamma} \quad \text{where, } \alpha = D / A = 1$$

$$\beta = B / D = Z_{sm} - (1 - Y_{om} Z_{sm}) Z_{ss}$$

$$\Gamma = C / A = Y_{om}$$

$\left\{ \begin{array}{l} Z_{sm}: \text{measured impedance of short chip} \\ Z_{ss}: \text{residual impedance of short chip (0.556nH)} \\ Y_{om}: \text{measured admittance when opening the fixture} \end{array} \right\}$

(4) Lx and Qx shall be calculated with the following equation.

$$L_x = \frac{\text{Im}(Z_x)}{2\pi f} \quad , \quad Q_x = \frac{\text{Im}(Z_x)}{\text{Re}(Z_x)}$$

Lx :Inductance of chip coil
 Qx:Q of chip coil
 f :Measuring frequency