



Chipsmall Limited consists of a professional team with an average of over 10 year of expertise in the distribution of electronic components. Based in Hongkong, we have already established firm and mutual-benefit business relationships with customers from,Europe,America and south Asia,supplying obsolete and hard-to-find components to meet their specific needs.

With the principle of “Quality Parts,Customers Priority,Honest Operation,and Considerate Service”,our business mainly focus on the distribution of electronic components. Line cards we deal with include Microchip,ALPS,ROHM,Xilinx,Pulse,ON,Everlight and Freescale. Main products comprise IC,Modules,Potentiometer,IC Socket,Relay,Connector.Our parts cover such applications as commercial,industrial, and automotives areas.

We are looking forward to setting up business relationship with you and hope to provide you with the best service and solution. Let us make a better world for our industry!



Contact us

Tel: +86-755-8981 8866 Fax: +86-755-8427 6832

Email & Skype: info@chipsmall.com Web: www.chipsmall.com

Address: A1208, Overseas Decoration Building, #122 Zhenhua RD., Futian, Shenzhen, China



CHIP COIL (CHIP INDUCTORS) LQW15AN□□□8ZD
Murata Standard Reference Specification 【AEC-Q200】

1.Scope

This reference specification applies to LQW15AN_8ZD series, Chip coil(Chip Inductors) for automotive Electronics based on AEC-Q200 except for Power train and Safety.

2.Part Numbering

(ex) LQ W 15 A N 1N3 C 8 Z D
 Product ID Structure Dimension (L×W) Applications and Characteristics Category Inductance Tolerance Features Application Packaging
 Z:Automotive D:Taping

3.Rating

- Operating Temperature Range. -55°C ~ +125°C
- Storage Temperature Range. -55°C ~ +125°C

Customer Part Number	MURATA Part Number	Inductance		Q (min.)	DC Resistance (Ω max.)	Self Resonant Frequency (GHz min.)	Rated Current (mA)	ESD Rank 6:25kV
		(nH)	Tolerance					
	LQW15AN1N3C8ZD	1.3	C:±0.2nH D:±0.5nH	20	0.012	18.0	3150	6
	LQW15AN1N3D8ZD							
	LQW15AN1N5C8ZD							
	LQW15AN1N5D8ZD							
	LQW15AN1N6C8ZD							
	LQW15AN1N6D8ZD	1.5	C:±0.2nH D:±0.5nH	20	0.028	18.0	2100	6
	LQW15AN1N6C8ZD							
	LQW15AN1N6D8ZD							
	LQW15AN1N7C8ZD							
	LQW15AN1N7D8ZD							
	LQW15AN2N2B8ZD	2.2	B:±0.1nH C:±0.2nH D:±0.5nH G:±2%	30	0.045	15.5	2530	6
	LQW15AN2N2C8ZD							
	LQW15AN2N2D8ZD							
	LQW15AN2N2G8ZD							
	LQW15AN2N3B8ZD							
	LQW15AN2N3C8ZD	2.3	B:±0.1nH C:±0.2nH D:±0.5nH G:±2%	30	0.065	15.5	2100	6
	LQW15AN2N3D8ZD							
	LQW15AN2N3G8ZD							
	LQW15AN2N4B8ZD							
	LQW15AN2N4C8ZD							
	LQW15AN2N4D8ZD	2.4	B:±0.1nH C:±0.2nH D:±0.5nH G:±2%	30	0.030	14.5	1950	6
	LQW15AN2N4G8ZD							
	LQW15AN2N5B8ZD							
	LQW15AN2N5C8ZD							
	LQW15AN2N5D8ZD							
	LQW15AN2N5G8ZD	2.5	B:±0.1nH C:±0.2nH D:±0.5nH G:±2%	28	0.035	14.5	1500	6
	LQW15AN2N6B8ZD							
	LQW15AN2N6C8ZD							
	LQW15AN2N6D8ZD							
	LQW15AN2N6G8ZD							
	LQW15AN2N7B8ZD	2.6	B:±0.1nH C:±0.2nH D:±0.5nH G:±2%	27	0.047	13.5	1500	6
	LQW15AN2N7C8ZD							
	LQW15AN2N7D8ZD							
	LQW15AN2N7G8ZD							
	LQW15AN2N8B8ZD							
	LQW15AN2N8C8ZD	2.7	B:±0.1nH C:±0.2nH D:±0.5nH G:±2%	25	12.5	12.5	1500	6
	LQW15AN2N8D8ZD							
	LQW15AN2N8G8ZD							
	LQW15AN2N9B8ZD							
	LQW15AN2N9C8ZD							
	LQW15AN2N9D8ZD	2.8	B:±0.1nH C:±0.2nH D:±0.5nH G:±2%	25	12.5	12.5	1500	6
	LQW15AN2N9G8ZD							

Customer Part Number	MURATA Part Number	Inductance		Q (min.)	DC Resistance (Ω max.)	Self Resonant Frequency (GHz min.)	Rated Current (mA)	ESD Rank 6:25kV
		(nH)	Tolerance					
	LQW15AN3N0B8ZD	3.0		20	0.063	12.5	1350	6
	LQW15AN3N0C8ZD							
	LQW15AN3N0D8ZD							
	LQW15AN3N0G8ZD							
	LQW15AN3N3B8ZD	3.3				14.0	2000	6
	LQW15AN3N3C8ZD							
	LQW15AN3N3D8ZD							
	LQW15AN3N3G8ZD							
	LQW15AN3N4B8ZD	3.4		30	0.030			6
	LQW15AN3N4C8ZD							
	LQW15AN3N4D8ZD							
	LQW15AN3N4G8ZD							
	LQW15AN3N5B8ZD	3.5				10.0	1950	6
	LQW15AN3N5C8ZD							
	LQW15AN3N5D8ZD							
	LQW15AN3N5G8ZD							
	LQW15AN3N6B8ZD	3.6						6
	LQW15AN3N6C8ZD							
	LQW15AN3N6D8ZD							
	LQW15AN3N6G8ZD							
	LQW15AN3N7B8ZD	3.7						6
	LQW15AN3N7C8ZD							
	LQW15AN3N7D8ZD							
	LQW15AN3N7G8ZD							
	LQW15AN3N8B8ZD	3.8	B:±0.1nH C:±0.2nH D:±0.5nH G:±2%	35	0.030	10.0	1950	6
	LQW15AN3N8C8ZD							
	LQW15AN3N8D8ZD							
	LQW15AN3N8G8ZD							
	LQW15AN3N9B8ZD	3.9						6
	LQW15AN3N9C8ZD							
	LQW15AN3N9D8ZD							
	LQW15AN3N9G8ZD							
	LQW15AN4N0B8ZD	4.0						6
	LQW15AN4N0C8ZD							
	LQW15AN4N0D8ZD							
	LQW15AN4N0G8ZD							
	LQW15AN4N1B8ZD	4.1		30				6
	LQW15AN4N1C8ZD							
	LQW15AN4N1D8ZD							
	LQW15AN4N1G8ZD							
	LQW15AN4N2B8ZD	4.2			0.044	9.6	1800	6
	LQW15AN4N2C8ZD							
	LQW15AN4N2D8ZD							
	LQW15AN4N2G8ZD							
	LQW15AN4N3B8ZD	4.3		32				6
	LQW15AN4N3C8ZD							
	LQW15AN4N3D8ZD							
	LQW15AN4N3G8ZD							
	LQW15AN4N4B8ZD	4.4		34	0.052		1600	6
	LQW15AN4N4C8ZD							
	LQW15AN4N4D8ZD							
	LQW15AN4N4G8ZD							

Customer Part Number	MURATA Part Number	Inductance		Q (min.)	DC Resistance (Ω max.)	Self Resonant Frequency (GHz min.)	Rated Current (mA)	ESD Rank 6:25kV
		(nH)	Tolerance					
	LQW15AN4N5B8ZD	4.5		34	0.060	9.6	1450	6
	LQW15AN4N5C8ZD							
	LQW15AN4N5D8ZD							
	LQW15AN4N5G8ZD							
	LQW15AN4N6B8ZD	4.6		32				
	LQW15AN4N6C8ZD							
	LQW15AN4N6D8ZD							
	LQW15AN4N6G8ZD							
	LQW15AN4N7B8ZD	4.7		31				
	LQW15AN4N7C8ZD							
	LQW15AN4N7D8ZD							
	LQW15AN4N7G8ZD							
	LQW15AN4N8B8ZD	4.8		30	0.071	8.0	1200	6
	LQW15AN4N8C8ZD							
	LQW15AN4N8D8ZD							
	LQW15AN4N8G8ZD							
	LQW15AN4N9B8ZD	4.9		27				
	LQW15AN4N9C8ZD							
	LQW15AN4N9D8ZD							
	LQW15AN4N9G8ZD							
	LQW15AN5N0B8ZD	5.0		32		10.0		
	LQW15AN5N0C8ZD							
	LQW15AN5N0D8ZD							
	LQW15AN5N0G8ZD							
	LQW15AN5N1B8ZD	5.1	B: \pm 0.1nH C: \pm 0.2nH D: \pm 0.5nH G: \pm 2%					
	LQW15AN5N1C8ZD							
	LQW15AN5N1D8ZD							
	LQW15AN5N1G8ZD							
	LQW15AN5N2B8ZD	5.2						
	LQW15AN5N2C8ZD							
	LQW15AN5N2D8ZD							
	LQW15AN5N2G8ZD							
	LQW15AN5N3B8ZD	5.3		35				
	LQW15AN5N3C8ZD							
	LQW15AN5N3D8ZD							
	LQW15AN5N3G8ZD							
	LQW15AN5N4B8ZD	5.4			0.040	8.0	1770	
	LQW15AN5N4C8ZD							
	LQW15AN5N4D8ZD							
	LQW15AN5N4G8ZD							
	LQW15AN5N5B8ZD	5.5						
	LQW15AN5N5C8ZD							
	LQW15AN5N5D8ZD							
	LQW15AN5N5G8ZD							
	LQW15AN5N6B8ZD	5.6						
	LQW15AN5N6C8ZD							
	LQW15AN5N6D8ZD							
	LQW15AN5N6G8ZD							
	LQW15AN5N7B8ZD	5.7						
	LQW15AN5N7C8ZD							
	LQW15AN5N7D8ZD							
	LQW15AN5N7G8ZD							
	LQW15AN5N8B8ZD	5.8		30				
	LQW15AN5N8C8ZD							
	LQW15AN5N8D8ZD							
	LQW15AN5N8G8ZD							

Customer Part Number	MURATA Part Number	Inductance		Q (min.)	DC Resistance (Ω max.)	Self Resonant Frequency (GHz min.)	Rated Current (mA)	ESD Rank 6:25kV										
		(nH)	Tolerance															
	LQW15AN5N9B8ZD	5.9	B: ± 0.1 nH C: ± 0.2 nH D: ± 0.5 nH G: $\pm 2\%$	30	0.040	8.0	1770	6										
	LQW15AN5N9C8ZD																	
	LQW15AN5N9D8ZD																	
	LQW15AN5N9G8ZD																	
	LQW15AN6N0B8ZD	6.0		B: ± 0.1 nH C: ± 0.2 nH D: ± 0.5 nH G: $\pm 2\%$	32	0.056	8.0		1600	6								
	LQW15AN6N0C8ZD																	
	LQW15AN6N0D8ZD																	
	LQW15AN6N0G8ZD																	
	LQW15AN6N1B8ZD	6.1			B: ± 0.1 nH C: ± 0.2 nH D: ± 0.5 nH G: $\pm 2\%$	32	0.056		8.0		1600	6						
	LQW15AN6N1C8ZD																	
	LQW15AN6N1D8ZD																	
	LQW15AN6N1G8ZD																	
	LQW15AN6N2B8ZD	6.2	B: ± 0.1 nH C: ± 0.2 nH D: ± 0.5 nH G: $\pm 2\%$			33	0.056	8.0	1600		6							
	LQW15AN6N2C8ZD																	
	LQW15AN6N2D8ZD																	
	LQW15AN6N2G8ZD																	
	LQW15AN6N3G8ZD	6.3		G: $\pm 2\%$ J: $\pm 5\%$		32	0.057	7.8	1380	6								
	LQW15AN6N3J8ZD																	
	LQW15AN6N4G8ZD	6.4				G: $\pm 2\%$ J: $\pm 5\%$	33	0.065	7.0				1280	6				
	LQW15AN6N4J8ZD																	
	LQW15AN6N5G8ZD	6.5			G: $\pm 2\%$ J: $\pm 5\%$		32	0.068	7.0			1450	6					
	LQW15AN6N5J8ZD																	
	LQW15AN6N6G8ZD	6.6					G: $\pm 2\%$ J: $\pm 5\%$	30	0.069			8.5			1420	6		
	LQW15AN6N6J8ZD																	
	LQW15AN6N7G8ZD	6.7	G: $\pm 2\%$ J: $\pm 5\%$					30	0.069		8.0	1700			6			
	LQW15AN6N7J8ZD																	
	LQW15AN6N8G8ZD	6.8						G: $\pm 2\%$ J: $\pm 5\%$	32		0.050	7.0					1500	6
	LQW15AN6N8J8ZD																	
	LQW15AN6N9G8ZD	6.9		G: $\pm 2\%$ J: $\pm 5\%$					32	0.050	7.0	1500					6	
	LQW15AN6N9J8ZD																	
	LQW15AN7N0G8ZD	7.0				G: $\pm 2\%$ J: $\pm 5\%$			33	0.069	8.0	1500		6				
	LQW15AN7N0J8ZD																	
	LQW15AN7N1G8ZD	7.1			G: $\pm 2\%$ J: $\pm 5\%$				32	0.069	6.5	1500	6					
	LQW15AN7N1J8ZD																	
	LQW15AN7N2G8ZD	7.2					G: $\pm 2\%$ J: $\pm 5\%$		30	0.069	6.5	1500				6		
	LQW15AN7N2J8ZD																	
	LQW15AN7N3G8ZD	7.3	G: $\pm 2\%$ J: $\pm 5\%$						30	0.069	6.5	1500			6			
	LQW15AN7N3J8ZD																	
	LQW15AN7N4G8ZD	7.4						G: $\pm 2\%$ J: $\pm 5\%$	35	0.069	6.5	1500						6
	LQW15AN7N4J8ZD																	
	LQW15AN7N5G8ZD	7.5		G: $\pm 2\%$ J: $\pm 5\%$					30	0.069	6.5	1500					6	
	LQW15AN7N5J8ZD																	
	LQW15AN7N6G8ZD	7.6				G: $\pm 2\%$ J: $\pm 5\%$			30	0.069	6.5	1500		6				
	LQW15AN7N6J8ZD																	
	LQW15AN7N7G8ZD	7.7			G: $\pm 2\%$ J: $\pm 5\%$				30	0.069	6.5	1500	6					
	LQW15AN7N7J8ZD																	
	LQW15AN7N8G8ZD	7.8					G: $\pm 2\%$ J: $\pm 5\%$		30	0.069	6.5	1500				6		
	LQW15AN7N8J8ZD																	
	LQW15AN7N9G8ZD	7.9	G: $\pm 2\%$ J: $\pm 5\%$						30	0.069	6.5	1500			6			
	LQW15AN7N9J8ZD																	
	LQW15AN8N0G8ZD	8.0						G: $\pm 2\%$ J: $\pm 5\%$	32	0.069	6.5	1500						6
	LQW15AN8N0J8ZD																	
	LQW15AN8N1G8ZD	8.1		G: $\pm 2\%$ J: $\pm 5\%$					32	0.069	6.5	1500					6	
	LQW15AN8N1J8ZD																	
	LQW15AN8N2G8ZD	8.2				G: $\pm 2\%$ J: $\pm 5\%$			32	0.069	6.5	1500		6				
	LQW15AN8N2J8ZD																	

Customer Part Number	MURATA Part Number	Inductance		Q (min.)	DC Resistance (Ω max.)	Self Resonant Frequency (GHz min.)	Rated Current (mA)	ESD Rank 6:25kV
		(nH)	Tolerance					
	LQW15AN8N3G8ZD	8.3	G: \pm 2% J: \pm 5%	32	0.069	6.5	1500	6
	LQW15AN8N3J8ZD							
	LQW15AN8N4G8ZD							
	LQW15AN8N4J8ZD							
	LQW15AN8N5G8ZD	8.5						
	LQW15AN8N5J8ZD							
	LQW15AN8N6G8ZD	8.6						
	LQW15AN8N6J8ZD							
	LQW15AN8N6G8ZD	8.6						
	LQW15AN8N6J8ZD							
	LQW15AN8N7G8ZD	8.7						
	LQW15AN8N7J8ZD							
	LQW15AN8N8G8ZD	8.8						
	LQW15AN8N8J8ZD							
	LQW15AN8N9G8ZD	8.9						
	LQW15AN8N9J8ZD							
	LQW15AN9N0G8ZD	9.0						
	LQW15AN9N0J8ZD							
	LQW15AN9N1G8ZD	9.1						
	LQW15AN9N1J8ZD							
	LQW15AN9N2G8ZD	9.2						
	LQW15AN9N2J8ZD							
	LQW15AN9N3G8ZD	9.3						
	LQW15AN9N3J8ZD							
	LQW15AN9N4G8ZD	9.4						
	LQW15AN9N4J8ZD							
	LQW15AN9N5G8ZD	9.5						
	LQW15AN9N5J8ZD							
	LQW15AN9N6G8ZD	9.6						
	LQW15AN9N6J8ZD							
	LQW15AN9N7G8ZD	9.7						
	LQW15AN9N7J8ZD							
	LQW15AN9N8G8ZD	9.8						
	LQW15AN9N8J8ZD							
	LQW15AN9N9G8ZD	9.9						
	LQW15AN9N9J8ZD							
	LQW15AN10NG8ZD	10						
	LQW15AN10NJ8ZD							
	LQW15AN11NG8ZD	11						
	LQW15AN11NJ8ZD							
	LQW15AN12NG8ZD	12						
	LQW15AN12NJ8ZD							
	LQW15AN13NG8ZD	13						
	LQW15AN13NJ8ZD							
	LQW15AN14NG8ZD	14						
	LQW15AN14NJ8ZD							
	LQW15AN15NG8ZD	15						
	LQW15AN15NJ8ZD							
	LQW15AN16NG8ZD	16						
	LQW15AN16NJ8ZD							
	LQW15AN17NG8ZD	17						
	LQW15AN17NJ8ZD							
	LQW15AN18NG8ZD	18						
	LQW15AN18NJ8ZD							
	LQW15AN19NG8ZD	19						
	LQW15AN19NJ8ZD							

Customer Part Number	MURATA Part Number	Inductance		Q (min.)	DC Resistance (Ω max.)	Self Resonant Frequency (GHz min.)	Rated Current (mA)	ESD Rank 6:25kV
		(nH)	Tolerance					
	LQW15AN20NG8ZD	20	G:±2% J:±5%	30	0.186	4.5	800	6
	LQW15AN20NJ8ZD							
	LQW15AN21NG8ZD	21			0.202		780	
	LQW15AN21NJ8ZD							
	LQW15AN22NG8ZD	22		0.201	760			
	LQW15AN22NJ8ZD							
	LQW15AN23NG8ZD	23		31	0.212	4.0	770	
	LQW15AN23NJ8ZD							
	LQW15AN24NG8ZD	24		31	0.221	4.1	750	
	LQW15AN24NJ8ZD							
	LQW15AN25NG8ZD	25		29	0.282		720	
	LQW15AN25NJ8ZD							
	LQW15AN26NG8ZD	26		29	0.288	4.0	680	
	LQW15AN26NJ8ZD							
	LQW15AN27NG8ZD	27		30	0.309	3.8	660	
	LQW15AN27NJ8ZD							
	LQW15AN30NG8ZD	30		30	0.336	3.6	620	
	LQW15AN30NJ8ZD							
	LQW15AN33NG8ZD	33		36	0.431	3.5	540	
	LQW15AN33NJ8ZD							
	LQW15AN36NG8ZD	36	28	0.456	3.4	530		
	LQW15AN36NJ8ZD							
	LQW15AN39NG8ZD	39	30	0.516	3.4	515		
	LQW15AN39NJ8ZD							
	LQW15AN43NG8ZD	43	47	0.648	3.2	440		
	LQW15AN43NJ8ZD							
	LQW15AN47NG8ZD	47	51	0.696	2.9	415		
	LQW15AN47NJ8ZD							
	LQW15AN51NG8ZD	51	53	0.996	2.5	340		
	LQW15AN51NJ8ZD							
	LQW15AN53NG8ZD	53	56	1.128	2.5	320		
	LQW15AN53NJ8ZD							
	LQW15AN56NG8ZD	56	68	1.224	2.4	320		
	LQW15AN56NJ8ZD							
	LQW15AN68NG8ZD	68	75	1.224	2.4	320		
	LQW15AN68NJ8ZD							
	LQW15AN75NG8ZD	75	75	1.224	2.4	320		
	LQW15AN75NJ8ZD							

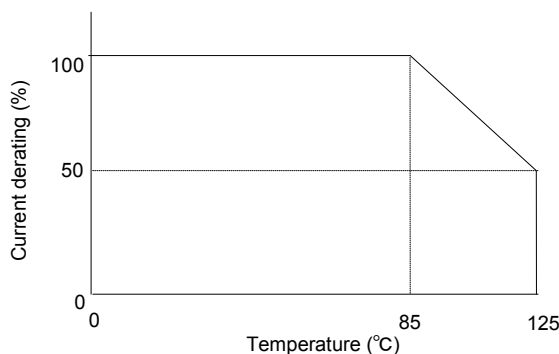

Derating of Rated Current depend on Operating Temperature

4. Testing Conditions

《Unless otherwise specified》

Temperature : Ordinary Temperature / 15°C to 35°C
 Humidity : Ordinary Humidity / 25%(RH) to 85%(RH)

《In case of doubt》

Temperature : 20°C±2°C
 Humidity : 60%(RH) to 70%(RH)
 Atmospheric Pressure : 86kPa to 106 kPa

5. Appearance and Dimensions

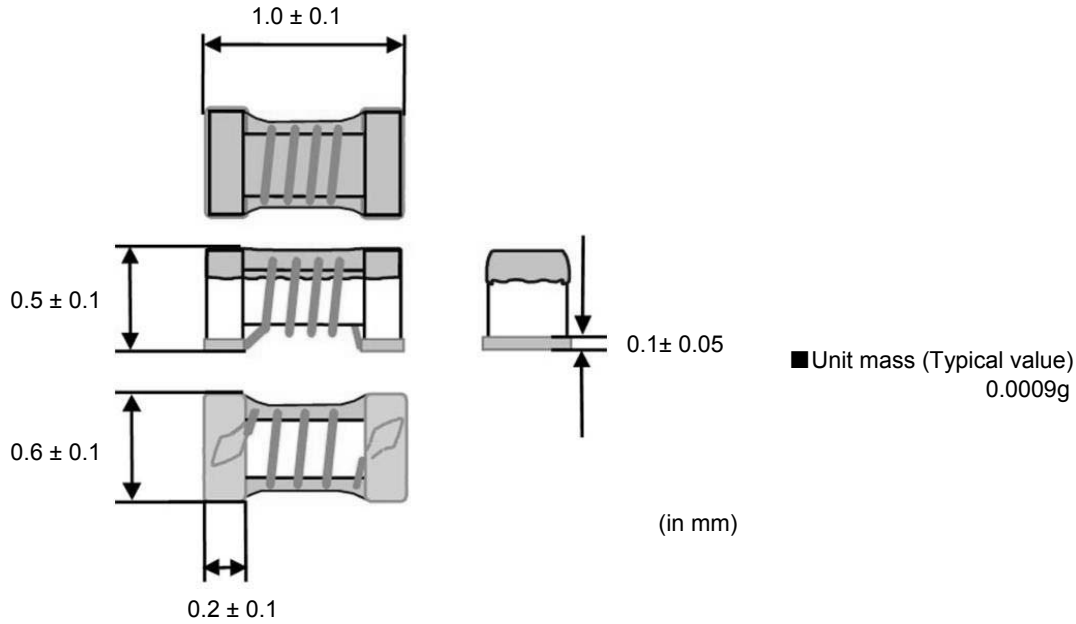

6. Electrical Performance

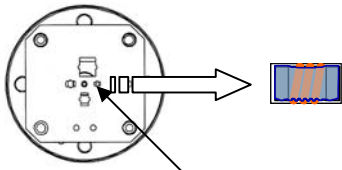
No.	Item	Specification	Test Method
6.1	Inductance	Inductance shall meet item 3.	Measuring Equipment: Agilent 4287A or equivalent Measuring Frequency: <Inductance> 100MHz <Q> 250MHz/1.3nH~43nH 200MHz/47nH~75nH Measuring Condition: Test signal level / about 0dBm Electrode spaces / 0.5mm Electrical length / 10mm
6.2	Q	Q shall meet item 3.	Measuring Fixture: Agilent 16197A Position coil under test as shown in below and contact coil with each terminal by adding weight.  <p style="text-align: center;">1005 Size Guide</p> Measuring Method: See P.14 <Electrical Performance: Measuring Method of Inductance/Q>
6.3	DC Resistance	DC Resistance shall meet item 3.	Measuring Equipment: Digital multi meter
6.4	Self Resonant Frequency(S.R.F)	S.R.F shall meet item 3.	Measuring Equipment: Agilent 5230A or equivalent
6.5	Rated Current	Self temperature rise shall be limited to 40°C max.	The rated current is applied.

7. Q200 Requirement**7.1.Performance (based on Table 5 for Magnetics(Inductors / Transformer)**

AEC-Q200 Rev.D issued June 1. 2010

AEC-Q200			Murata Specification / Deviation				
No	Stress	Test Method					
3	High Temperature Exposure	1000hours at 125 deg C Set for 24hours at room temperature, then measured.	Meet Table A after testing. Table A <table border="1"> <tr> <td>Appearance</td> <td>No damage</td> </tr> <tr> <td>Inductance (at 100MHz)</td> <td>Within ±5%</td> </tr> </table>	Appearance	No damage	Inductance (at 100MHz)	Within ±5%
Appearance	No damage						
Inductance (at 100MHz)	Within ±5%						
4	Temperature Cycling	1000cycles -40 deg C to +125 deg C Set for 24hours at room temperature, then measured.	Meet Table A after testing.				
7	Biased Humidity	1000hours at 85 deg C, 85%RH unpowered..	Meet Table A after testing.				
8	Operational Life	Apply 125 deg C 1000hours Set for 24hours at room temperature, then measured	Meet Table A after testing.				
9	External Visual	Visual inspection	No abnormalities				
10	Physical Dimension	Meet ITEM 5 (Style and Dimensions)	No defects				
12	Resistance to Solvents	Per MIL-STD-202 Method 215	Not Applicable				
13	Mechanical Shock	Per MIL-STD-202 Method 213 Condition C : 100g's(0.98N), 6ms, Half sine, 12.3ft/s	Meet Table A after testing.				
14	Vibration	5g's(0.049N) for 20 minutes, 12cycles each of 3 orientations Test from 10-2000Hz.	Meet Table A after testing.				
15	Resistance to Soldering Heat	No-heating Solder temperature 260C+/-5 deg C Immersion time 10s	Pre-heating: 150C +/-10 deg C, 60s to 90s Meet Table A after testing.				

AEC-Q200			Murata Specification / Deviation				
No	Stress	Test Method					
17	ESD	Per AEC-Q200-002	ESD Rank: Refer to Item 3. Rating. Meet Table A after testing				
18	Solderability	Per J-STD-002	Method b : Not Applicable 95% of the terminations is to be soldered. (Except exposed wire)				
19	Electrical Characterization	Measured : Inductance	No defects				
20	Flammability	Per UL-94	Not Applicable				
21	Board Flex	Epoxy-PCB(1.6mm) Deflection 2mm(min) Holding time 60s	Meet Table B after testing. Table B <table border="1" style="margin-left: auto; margin-right: auto;"> <tr> <td>Appearance</td> <td>No damage</td> </tr> <tr> <td>DC resistance change</td> <td>Within ±10%</td> </tr> </table>	Appearance	No damage	DC resistance change	Within ±10%
Appearance	No damage						
DC resistance change	Within ±10%						
22	Terminal Strength	Per AEC-Q200-006 A force of 17.7N for 60s	No defects Murata Deviation Request: 5N/60s				

8.Specification of Packaging

8.1 Appearance and Dimensions of paper tape (8mm-wide)

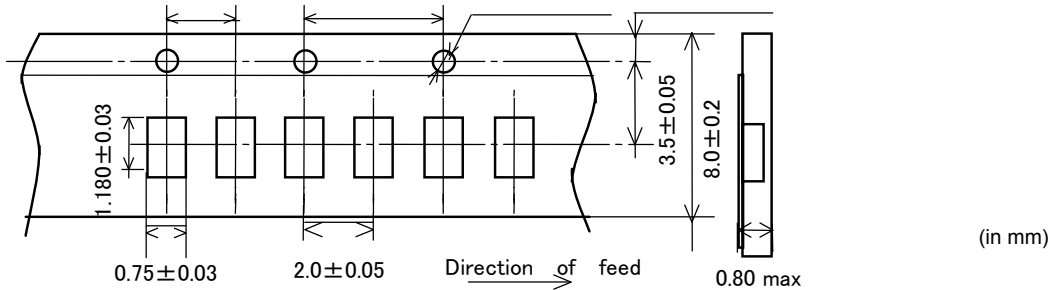

8.2 Specification of Taping

- (1) Packing quantity (standard quantity)
10,000 pcs. / reel
- (2) Packing Method
Products shall be packed in the cavity of the base tape and sealed by Cover tape.
- (3) Sprocket hole
The sprocket holes are to the right as the tape is pulled toward the user.
- (4) Spliced point
Base tape and Cover tape has no spliced point.
- (5) Missing components number
Missing components number within 0.1% of the number per reel or 1 pc., whichever is greater, and are not continuous. The Specified quantity per reel is kept.

8.3 Pull Strength

Cover tape	5N min.
------------	---------

10. Notice

Products can only be soldered with reflow.
This product is designed for solder mounting.
Please consult us in advance for applying other mounting method such as conductive adhesive.

10.1 Land pattern designing

Recommended land patterns for reflow soldering are as follows:

These have been designed for Electric characteristics and solderability.

Please follow the recommended patterns. Otherwise, their performance which includes electrical performance or solderability may be affected, or result to "position shift" in soldering process.

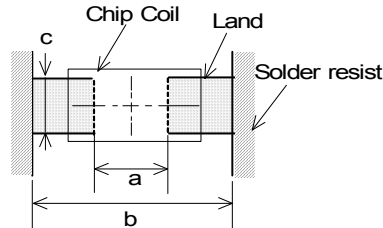

a	0.6
b	1.42
c	0.66

(in mm)

10.2 Flux, Solder

- Use rosin-based flux.
Includes middle activator equivalent to 0.06(wt)% to 0.1(wt)% Chlorine.
Don't use highly acidic flux with halide content exceeding 0.2(wt)% (chlorine conversion value).
Don't use water-soluble flux.
- Use Sn-3.0Ag-0.5Cu solder.
- Standard thickness of solder paste : 50 μ m to 100 μ m.

10.3 Reflow soldering conditions

- Pre-heating should be in such a way that the temperature difference between solder and product surface is limited to 150°C max. Cooling into solvent after soldering also should be in such a way that the temperature difference is limited to 100°C max.
Insufficient pre-heating may cause cracks on the product, resulting in the deterioration of products quality.
- Standard soldering profile and the limit soldering profile is as follows.
The excessive limit soldering conditions may cause leaching of the electrode and / or resulting in the deterioration of product quality.

- Reflow soldering profile

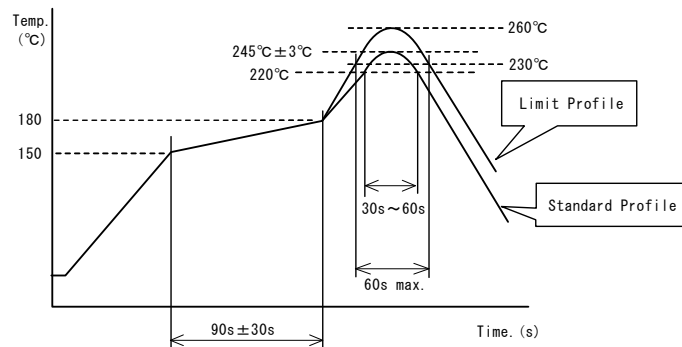

	Standard Profile	Limit Profile
Pre-heating	150°C ~ 180°C , 90s ± 30s	
Heating	above 220°C, 30s ~ 60s	above 230°C, 60s max.
Peak temperature	245°C ± 3°C	260°C, 10s
Cycle of reflow	2 times	2 times

10.4 Reworking with soldering iron

The following conditions must be strictly followed when using a soldering iron.

Pre-heating	150°C, 1 min
Tip temperature	350°C max.
Soldering iron output	80W max.
Tip diameter	φ 3mm max.
Soldering time	3(+1,-0)s
Time	2 times

Note :Do not directly touch the products with the tip of the soldering iron in order to prevent the crack on the products due to the thermal shock.

10.5 Solder Volume

- Solder shall be used not to be exceeded the upper limits as shown below.
- Accordingly increasing the solder volume, the mechanical stress to Chip is also increased. Exceeding solder volume may cause the failure of mechanical or electrical performance.

$$1/3T \leq t \leq T$$

T : thickness of product

10.6 Product's location

The following shall be considered when designing and laying out P.C.B.'s.

- (1) P.C.B. shall be designed so that products are not subject to the mechanical stress due to warping the board.

[Products direction]

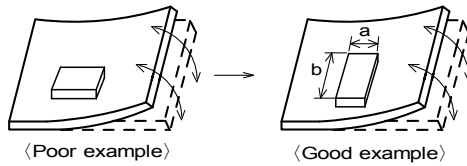

Products shall be located in the sideways direction (Length:a<b) to the mechanical stress.

- (2) Products location on P.C.B. separation

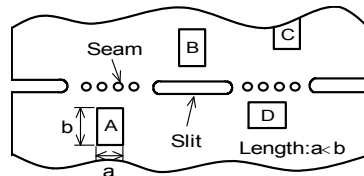

Products (A,B,C,D) shall be located carefully so that products are not subject to the mechanical stress due to warping the board. Because they may be subjected the mechanical stress in order of $A > C > B \cong D$.

10.7 Cleaning Conditions

Products shall be cleaned on the following conditions.

- (1) Cleaning temperature shall be limited to 60°C max.(40°C max for IPA)
- (2) Ultrasonic cleaning shall comply with the following conditions with avoiding the resonance phenomenon at the mounted products and P.C.B.
Power : 20 W / l max. Frequency : 28kHz to 40kHz Time : 5 min max.
- (3) Cleaner
 1. Alcohol type cleaner
Isopropyl alcohol (IPA)
 2. Aqueous agent
PINE ALPHA ST-100S
- (4) There shall be no residual flux and residual cleaner after cleaning.
In the case of using aqueous agent, products shall be dried completely after rinse with de-ionized water in order to remove the cleaner.
- (5) Other cleaning Please contact us.

10.8 Resin coating

The inductance value may change due to high cure-stress of resin to be used for coating/molding products. An open circuit issue may occur by mechanical stress caused by the resin, amount/cured shape of resin, or operating condition etc. Some resin contains some impurities or chloride possible to generate chlorine by hydrolysis under some operating condition may cause corrosion of wire of coil, leading to open circuit. So, please pay your careful attention when you select resin in case of coating/molding the products with the resin. Prior to use the coating resin, please make sure no reliability issue is observed by evaluating products mounted on your board.

10.9 Caution for use

- Sharp material such as a pair of tweezers or other material such as bristles of cleaning brush , shall not be touched to the winding portion to prevent the breaking of wire.
- Mechanical shock should not be applied to the products mounted on the board to prevent the breaking of the core.

10.10 Notice of product handling at mounting

In some mounting machines, when picking up components support pin pushes up the components from the bottom of base tape. In this case, please remove the support pin. The support pin may damage the components and break wire.

In rare case ,the laser recognition can not recognize this component. Please contact us when you use laser recognition. (There is no problem with the permeation and reflection type.)

10.11 Handling of a substrate

After mounting products on a substrate, do not apply any stress to the product caused by bending or twisting to the substrate when cropping the substrate, inserting and removing a connector from the substrate or tightening screw to the substrate.

Excessive mechanical stress may cause cracking in the product.

Bending

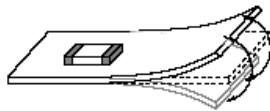

Twisting

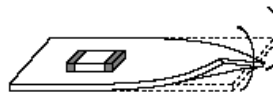
**10.12 Storage and Handling Requirements****(1) Storage period**

- Use the products within 12 months after delivered.
- Solderability should be checked if this period is exceeded.

(2) Storage conditions

- Products should be stored in the warehouse on the following conditions.
 - Temperature : -10°C to 40°C
 - Humidity : 15% to 85% relative humidity No rapid change on temperature and humidity
- Don't keep products in corrosive gases such as sulfur, chlorine gas or acid, or it may cause oxidization of electrode, resulting in poor solderability.
- Products should not be stored on bulk packaging condition to prevent the chipping of the core and the breaking of winding wire caused by the collision between the products.
- Products should be stored on the palette for the prevention of the influence from humidity, dust and so on.
- Products should be stored in the warehouse without heat shock, vibration, direct sunlight and so on.

(3) Handling Condition

- Care should be taken when transporting or handling product to avoid excessive vibration or mechanical shock.

11. ⚠ Note

- (1) Please make sure that your product has been evaluated in view of your specifications with our product being mounted to your product.
- (2) You are requested not to use our product deviating from the reference specifications.
- (3) The contents of this reference specification are subject to change without advance notice. Please approve our product specifications or transact the approval sheet for product specifications before ordering.

<Electrical Performance:Measuring Method of Inductance/Q>

(1) Residual elements and stray elements of test fixture can be described by F-parameter shown in following.

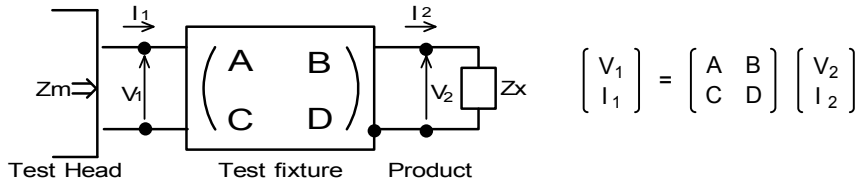

(2) The impedance of chip coil Z_x and measured value Z_m can be described by input/output current/voltage.

$$Z_m = \frac{V_1}{I_1} \quad , \quad Z_x = \frac{V_2}{I_2}$$

(3) Thus,the relation between Z_x and Z_m is following;

$$Z_x = \alpha \frac{Z_m - \beta}{1 - Z_m \Gamma} \quad \text{where, } \alpha = D / A = 1$$

$$\beta = B / D = Z_{sm} - (1 - Y_{om} Z_{sm}) Z_{ss}$$

$$\Gamma = C / A = Y_{om}$$

- Z_{sm} : measured impedance of short chip
- Z_{ssa} : residual impedance of short chip (0.556nH)
- Y_{om} : measured admittance when opening the fixture

(4) L_x shall be calculated with the following equation.

$$L_x = \frac{\text{Im}(Z_x)}{2\pi f} \quad , \quad Q_x = \frac{\text{Im}(Z_x)}{\text{Re}(Z_x)}$$

L_x : Inductance of chip coil
 Q_x : Q of chip coil
 f : Measuring frequency