



Chipsmall Limited consists of a professional team with an average of over 10 year of expertise in the distribution of electronic components. Based in Hongkong, we have already established firm and mutual-benefit business relationships with customers from,Europe,America and south Asia,supplying obsolete and hard-to-find components to meet their specific needs.

With the principle of "Quality Parts,Customers Priority,Honest Operation,and Considerate Service",our business mainly focus on the distribution of electronic components. Line cards we deal with include Microchip,ALPS,ROHM,Xilinx,Pulse,ON,Everlight and Freescale. Main products comprise IC,Modules,Potentiometer,IC Socket,Relay,Connector.Our parts cover such applications as commercial,industrial, and automotives areas.

We are looking forward to setting up business relationship with you and hope to provide you with the best service and solution. Let us make a better world for our industry!



Contact us

Tel: +86-755-8981 8866 Fax: +86-755-8427 6832

Email & Skype: info@chipsmall.com Web: www.chipsmall.com

Address: A1208, Overseas Decoration Building, #122 Zhenhua RD., Futian, Shenzhen, China



Reference Only

CHIP COIL (CHIP INDUCTORS) LQW15CA□□□□00D REFERENCE SPECIFICATION

1.Scope

This reference specification applies to LQW15CA_00 series, Chip coil (Chip Inductors).

2.Part Numbering

(ex)

LQ	W	15	C	A	R56	J	0	0	D
Product ID	Structure	Dimension (L×W)	Applications and Characteristics	Category	Inductance	Tolerance	Features	Electrode	Packaging D:Taping *B:Bulk

* Bulk packing also available. (A product is put in the plastic bag under the taping conditions.)

3.Rating

- Operating Temperature Range. −40°C to +125°C (includes self-heating)
- Storage Temperature Range. −55°C to +125°C

Customer Part Number	MURATA Part Number	Inductance		Impedance typ(Ω)		DC Resistance (Ωmax)	Self Resonant Frequency (MHz min.)	Rated Current (mA)	
		(nH)	Tolerance	900MHz	1700MHz				
	LQW15CA22NJ00D	22	J:±5% K:±10%		100	150	0.060	3000	1300
	LQW15CA22NK00D								
	LQW15CA39NJ00D	39			180	280	0.075	2700	1100
	LQW15CA39NK00D								
	LQW15CA59NJ00D	59			290	360	0.095	2300	1000
	LQW15CA59NK00D								
	LQW15CA83NJ00D	83			430	750	0.120	1700	970
	LQW15CA83NK00D								
	LQW15CAR11J00D	110			580	1000	0.130	1600	900
	LQW15CAR11K00D								
	LQW15CAR14J00D	140			780	1300	0.180	1400	680
	LQW15CAR14K00D								
	LQW15CAR18J00D	180			1000	1700	0.210	1300	640
	LQW15CAR18K00D								
	LQW15CAR22J00D	220			1400	2000	0.290	1300	540
	LQW15CAR22K00D								
	LQW15CAR27J00D	270			1800	2100	0.380	1200	480
	LQW15CAR27K00D								
	LQW15CAR32J00D	320			2200	2300	0.410	1100	420
	LQW15CAR32K00D								
	LQW15CAR37J00D	370	2800	2350	0.575	1000	360		
	LQW15CAR37K00D								
	LQW15CAR43J00D	430	3400	2400	0.680	920	360		
	LQW15CAR43K00D								
	LQW15CAR50J00D	500	4250	2400	0.97	900	270		
	LQW15CAR50K00D								
	LQW15CAR56J00D	560	4950	2350	1.00	900	270		
	LQW15CAR56K00D								
	LQW15CAR64J00D	640	5800	2400	1.40	870	240		
	LQW15CAR64K00D								
	LQW15CAR73J00D	730	6500	2450	1.95	810	200		
	LQW15CAR73K00D								
	LQW15CAR80J00D	800	7000	2500	2.10	770	190		
	LQW15CAR80K00D								
	LQW15CA1R0K00D	1000	K:±10%	5200	1600	2.2	400	180	
	LQW15CA2R0K00D	2000		510	610	3.2	120	130	

Reference Only

SpecNo.JELF243A-0140A-01

P.2/10

4. Testing Conditions

《Unless otherwise specified》

Temperature : Ordinary Temperature / 15°C to 35°C
 Humidity : Ordinary Humidity / 25%(RH) to 85%(RH)

《In case of doubt》

Temperature : 20°C±2°C
 Humidity : 60%(RH) to 70%(RH)
 Atmospheric Pressure : 86kPa to 106 kPa

5. Appearance and Dimensions

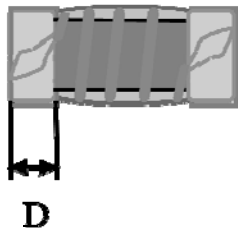
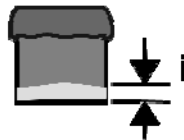
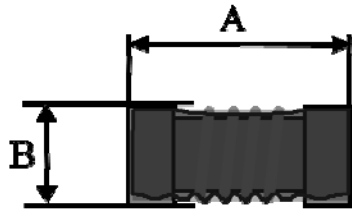

A	1.02 ± 0.10
B	0.55 ± 0.06
C	0.56 ± 0.1
D	0.3 ± 0.1
i	0.10 +0.2/-0.05

■ Unit Mass (Typical value)
0.0012g

6. Electrical Performance

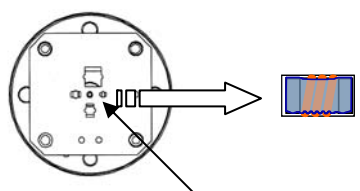
No.	Item	Specification	Test Method
6.1	Inductance	Inductance shall meet item 3.	Measuring Equipment: KEYSIGHT 4991A or equivalent Measuring Frequency: 10MHz Measuring Condition: Test signal level / about 0dBm Electrode spaces / 0.5mm Electrical length / 10mm Measuring Fixture: KEYSIGHT 16197A Position coil under test as shown in below and contact coil with each terminal by adding weight.  1005 Size Guide Measuring Method: See the endnote. <Electrical Performance:Measuring Method of Inductance>
6.2	DC Resistance		Measuring Equipment:Digital multi meter
6.3	Self Resonant Frequency (S.R.F)		Measuring Equipment: KEYSIGHT 5230A or equivalent
6.4	Rated Current	Self temperature rise shall be limited to 40°C max.	The rated current is applied.

7.Mechanical Performance

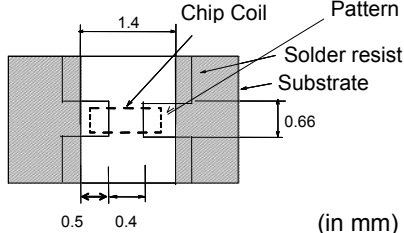
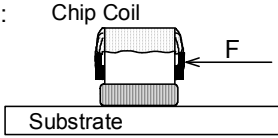
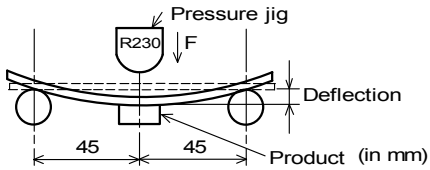
No.	Item	Specification	Test Method
7.1	Shear Test	Chip coil shall not be damaged after tested as test method.	<p>Substrate:Glass-epoxy substrate</p>  <p style="text-align: right;">(in mm)</p> <p>Applied Direction: </p> <p>Force:2.5N Hold Duration:60s±1s</p>
7.2	Bending Test		<p>Substrate:Glass-epoxy substrate (100mm×40mm×1.0mm)</p> <p>Speed of Applying Force:1mm / s Deflection:2mm Hold Duration:5s</p>  <p style="text-align: right;">Product (in mm)</p>
7.3	Vibration	Chip coil shall not be damaged after tested as test method.	<p>Oscillation Frequency : 10 to 2000 to 10Hz for 15 minutes.</p> <p>Total amplitude: 3 mm or Acceleration amplitude 196m/s² whichever is smaller.</p> <p>Time : A period of 2 hours in each of 3 mutually perpendicular directions. (Total 6hours)</p>
7.4	Solderability	The wetting area of the electrode shall be at least 90% covered with new solder coating.	<p>Flux:Ethanol solution of rosin,25(wt)% Includes activator equivalent to 0.06(wt)% chlorine.(immersed for 5s to 10s)</p> <p>Solder:Sn-3.0Ag-0.5Cu Pre-Heating:150°C±10°C / 60s to 90s Solder Temperature:240°C±5°C Immersion Time:3s±1s</p>
7.5	Resistance to Soldering Heat	Appearance:No damage Inductance Change: within ±5%	<p>Flux:Ethanol solution of rosin,25(wt)% Includes activator equivalent to 0.06(wt)% chlorine.(immersed for 5s to 10s)</p> <p>Solder:Sn-3.0Ag-0.5Cu Pre-Heating:150°C±10°C / 60s to 90s Solder Temperature:260°C±5°C Immersion Time:5s±1s Then measured after exposure in the room condition for 24h±2h.</p>

Reference Only

8.Environmental Performance

It shall be soldered on the substrate.

No.	Item	Specification	Test Method
8.1	Heat Resistance	Appearance:No damage Inductance Change: within $\pm 5\%$	Temperature: $125^{\circ}\text{C}\pm 2^{\circ}\text{C}$ Time:1000h (+48h,0h) Then measured after exposure in the room condition for 24h \pm 2h.
8.2	Cold Resistance		Temperature: $-55^{\circ}\text{C}\pm 2^{\circ}\text{C}$ Time:1000h (+48h,-0h) Then measured after exposure in the room condition for 24h \pm 2h.
8.3	Humidity		Temperature: $85^{\circ}\text{C}\pm 2^{\circ}\text{C}$ Humidity:80%(RH) to 85%(RH) Time:1000h (+48h,-0h) Then measured after exposure in the room condition for 24h \pm 2h.
8.4	Temperature Cycle		1 cycle: 1 step: $-55^{\circ}\text{C}\pm 2^{\circ}\text{C}$ / 30min \pm 3 min 2 step:Ordinary temp. / 10min to 15 min 3 step: $+125^{\circ}\text{C}\pm 2^{\circ}\text{C}$ / 30min \pm 3 min 4 step:Ordinary temp. / 10min to 15 min Total of 100 cycles Then measured after exposure in the room condition for 24h \pm 2h.

9.Specification of Packaging

9.1 Appearance and Dimensions of paper tape (8mm-wide, 2mm pitch)

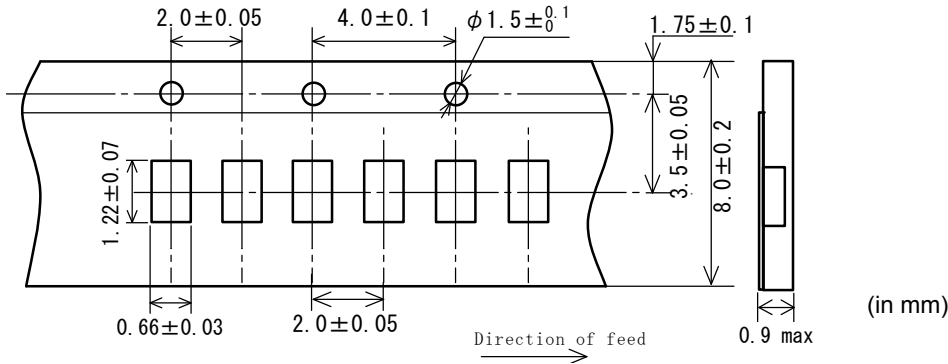

9.2 Specification of Taping

- (1) Packing quantity (standard quantity)
10,000 pcs. / reel
- (2) Packing Method
Products shall be packed in the cavity of the base tape and sealed by Cover tape.
- (3) Sprocket hole
The sprocket holes are to the right as the tape is pulled toward the user.
- (4) Spliced point
Base tape and Cover tape has no spliced point.
- (5) Missing components number
Missing components number within 0.1% of the number per reel or 1 pc., whichever is greater, and are not continuous. The Specified quantity per reel is kept.

9.3 Pull Strength

Cover tape	5N min.
------------	---------

9.4 Peeling off force of cover tape

Speed of Peeling off	300mm/min
Peeling off force	0.1N to 0.6N (minimum value is typical)

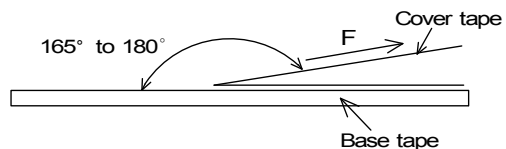

Reference Only

9.5 Dimensions of Leader-tape, Trailer and Reel

There shall be leader-tape (cover tape and empty tape) and trailer-tape (empty tape) as follows.

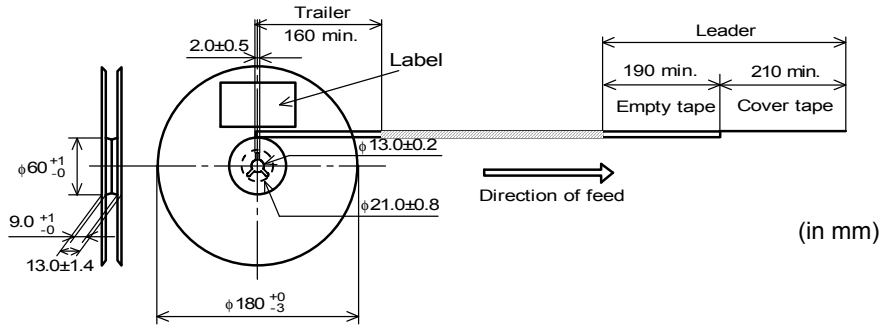

9.6 Marking for reel

Customer part number, MURATA part number, Inspection number(·1) ,RoHS Marking(·2), Quantity etc ...

· 1) <Expression of Inspection No.>

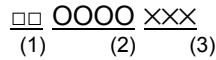

- (1) Factory code
- (2) Date First digit : Year / Last digit of year
 Second digit : Month / Jan. to Sep. · 1 to 9, Oct. to Dec. · O, N, D
 Third, Fourth digit : Day
- (3) Serial No.

· 2) <Expression of RoHS Marking >

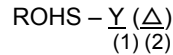

- (1) RoHS regulation conformity parts.
- (2) MURATA classification number

9.7 Marking for Outside package (corrugated paper box)

Customer name, Purchasing order number, Customer part number, MURATA part number, RoHS Marking (·2) ,Quantity, etc ...

9.8. Specification of Outer Case

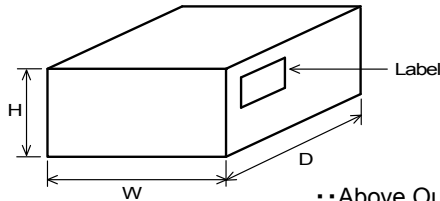

Outer Case Dimensions (mm)			Standard Reel Quantity in Outer Case (Reel)
W	D	H	
186	186	93	5

· · Above Outer Case size is typical. It depends on a quantity of an order.

10. ⚠ Caution

Limitation of Applications

Please contact us before using our products for the applications listed below which require especially high reliability for the prevention of defects which might directly cause damage to the third party's life, body or property.

- | | |
|-----------------------------------|--|
| (1) Aircraft equipment | (6) Transportation equipment (vehicles, trains, ships, etc.) |
| (2) Aerospace equipment | (7) Traffic signal equipment |
| (3) Undersea equipment | (8) Disaster prevention / crime prevention equipment |
| (4) Power plant control equipment | (9) Data-processing equipment |
| (5) Medical equipment | (10) Applications of similar complexity and /or reliability requirements to the applications listed in the above |

11. Notice

Products can only be soldered with reflow.
 This product is designed for solder mounting.
 Please consult us in advance for applying other mounting method such as conductive adhesive.

11.1 Land pattern designing

Recommended land patterns for reflow soldering are as follows:
 These have been designed for Electric characteristics and solderability.
 Please follow the recommended patterns. Otherwise, their performance which includes electrical performance or solderability may be affected, or result to "position shift" in soldering process.

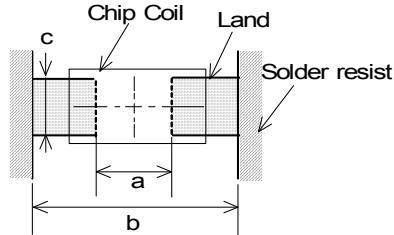

a	0.45
b	1.45
c	0.64

(in mm)

11.2 Flux, Solder

- Use rosin-based flux.
 Includes middle activator equivalent to 0.06(wt)% to 0.1(wt) % Chlorine.
 Don't use highly acidic flux with halide content exceeding 0.2(wt) % (chlorine conversion value).
 Don't use water-soluble flux.
- Use Sn-3.0Ag-0.5Cu solder.
- Standard thickness of solder paste : 50µm to 100µm.
- Please pay attention to solder paste's penetrating in order to avoid short circuit between the lines.

11.3 Reflow soldering conditions

- Pre-heating should be in such a way that the temperature difference between solder and product surface is limited to 100°C max. Cooling into solvent after soldering also should be in such a way that the temperature difference is limited to 100°C max.
 Insufficient pre-heating may cause cracks on the product, resulting in the deterioration of products quality.
- Standard soldering profile and the limit soldering profile is as follows.
 The excessive limit soldering conditions may cause leaching of the electrode and / or resulting in the deterioration of product quality.
- Reflow soldering profile

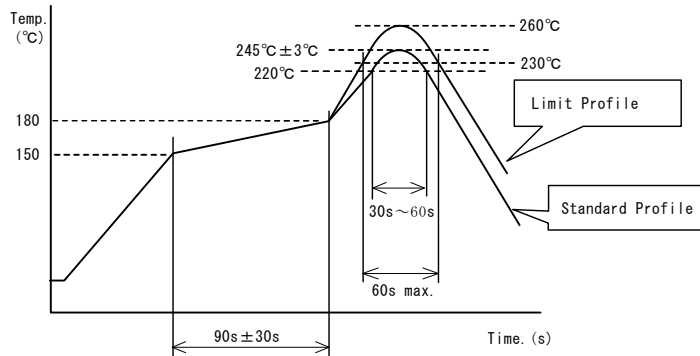

	Standard Profile	Limit Profile
Pre-heating	150°C~180°C , 90s±30s	
Heating	above 220°C, 30s~60s	above 230°C, 60s max.
Peak temperature	245°C±3°C	260°C, 10s
Cycle of reflow	2 times	2 times

Reference Only

11.4 Reworking with soldering iron

The following conditions must be strictly followed when using a soldering iron.

Pre-heating	150°C, 1 min
Tip temperature	350°C max.
Soldering iron output	80W max.
Tip diameter	φ3mm max.
Soldering time	3(+1,-0)s
Time	2 times

Note :Do not directly touch the products with the tip of the soldering iron in order to prevent the crack on the products due to the thermal shock.

11.5 Solder Volume

- Solder shall be used not to be exceed the upper limits as shown below.
- Accordingly increasing the solder volume, the mechanical stress to Chip is also increased. Exceeding solder volume may cause the failure of mechanical or electrical performance.

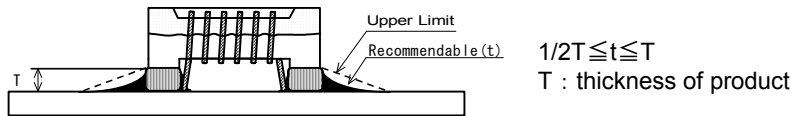

11.6 Product's location

The following shall be considered when designing and laying out P.C.B.'s.

- (1) P.C.B. shall be designed so that products are not subject to the mechanical stress due to warping the board.

[Products direction]

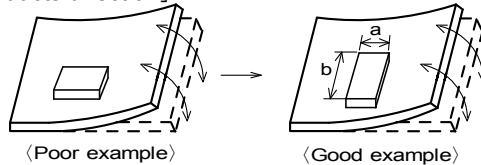

Products shall be located in the sideways direction (Length:a < b) to the mechanical stress.

- (2) Components location on P.C.B. separation.

It is effective to implement the following measures, to reduce stress in separating the board.

It is best to implement all of the following three measures; however, implement as many measures as possible to reduce stress.

Contents of Measures	Stress Level
(1) Turn the mounting direction of the component parallel to the board separation surface.	A > D *1
(2) Add slits in the board separation part.	A > B
(3) Keep the mounting position of the component away from the board separation surface.	A > C

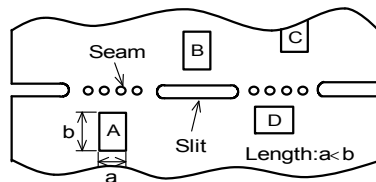

*1 A > D is valid when stress is added vertically to the perforation as with Hand Separation. If a Cutting Disc is used, stress will be diagonal to the PCB, therefore A > D is invalid.

(3) Mounting Components Near Screw Holes

When a component is mounted near a screw hole, it may be affected by the board deflection that occurs during the tightening of the screw. Mount the component in a position as far away from the screw holes as possible.

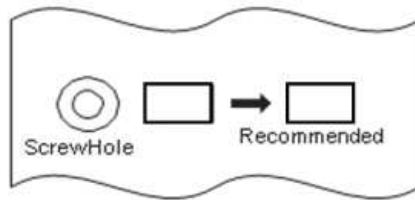

11.7 Cleaning Conditions

Products shall be cleaned on the following conditions.

(1) Cleaning temperature shall be limited to 60°C max.(40°C max for IPA)

(2) Ultrasonic cleaning shall comply with the following conditions with avoiding the resonance phenomenon at the mounted products and P.C.B.

Power : 20 W / l max. Frequency : 28kHz to 40kHz Time : 5 min max.

(3) Cleaner

1. Alcohol type cleaner
Isopropyl alcohol (IPA)

2. Aqueous agent
PINE ALPHA ST-100S

(4) There shall be no residual flux and residual cleaner after cleaning.

In the case of using aqueous agent, products shall be dried completely after rinse with de-ionized water in order to remove the cleaner.

(5) Other cleaning Please contact us.

11.8 Resin coating

The inductance value may change due to high cure-stress of resin to be used for coating/molding products.

An open circuit issue may occur by mechanical stress caused by the resin, amount/cured shape of resin, or operating condition etc. Some resin contains some impurities or chloride possible to generate chlorine by hydrolysis under some operating condition may cause corrosion of wire of coil, leading to open circuit.

So, please pay your careful attention when you select resin in case of coating/molding the products with the resin.

Prior to use the coating resin, please make sure no reliability issue is observed by evaluating products mounted on your board.

11.9 Caution for use

- Sharp material such as a pair of tweezers or other material such as bristles of cleaning brush , shall not be touched to the winding portion to prevent the breaking of wire.
- Mechanical shock should not be applied to the products mounted on the board to prevent the breaking of the core.

11.10 Notice of product handling at mounting

In some mounting machines,when picking up components support pin pushes up the components from the bottom of base tape. In this case, please remove the support pin. The support pin may damage the components and break wire.

In rare case ,the laser recognition can not recognize this component. Please contact us when you use laser recognition. (There is no problem with the permeation and reflection type.)

11.11 Handling of a substrate

After mounting products on a substrate, do not apply any stress to the product caused by bending or twisting to the substrate when cropping the substrate, inserting and removing a connector from the substrate or tightening screw to the substrate.

Excessive mechanical stress may cause cracking in the product.

Bending

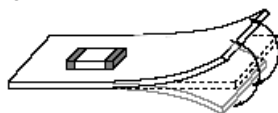

Twisting

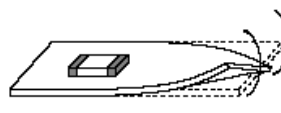

Reference Only

SpecNo.JELF243A-0140A-01

P.9/10

11.12 Storage and Handling Requirements

(1) Storage period

Use the products within 12 months after delivered.
Solderability should be checked if this period is exceeded.

(2) Storage conditions

- Products should be stored in the warehouse on the following conditions.
 - Temperature : -10°C to 40°C
 - Humidity : 15% to 85% relative humidity No rapid change on temperature and humidity
- Don't keep products in corrosive gases such as sulfur, chlorine gas or acid, or it may cause oxidization of electrode, resulting in poor solderability.
- Products should not be stored on bulk packaging condition to prevent the chipping of the core and the breaking of winding wire caused by the collision between the products.
- Products should be stored on the palette for the prevention of the influence from humidity, dust and so on.
- Products should be stored in the warehouse without heat shock, vibration, direct sunlight and so on.

(3) Handling Condition

Care should be taken when transporting or handling product to avoid excessive vibration or mechanical shock.

12. Note

- (1) Please make sure that your product has been evaluated in view of your specifications with our product being mounted to your product.
- (2) You are requested not to use our product deviating from the reference specifications.
- (3) The contents of this reference specification are subject to change without advance notice.

Please approve our product specifications or transact the approval sheet for product specifications before ordering.

Reference Only

<Electrical Performance:Measuring Method of Inductance >

(1) Residual elements and stray elements of test fixture can be described by F-parameter shown in following.

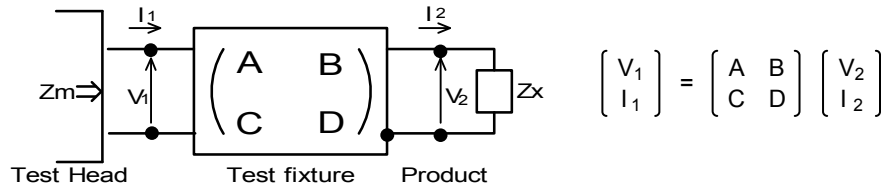

(2) The impedance of chip coil Z_x and measured value Z_m can be described by input/output current/voltage.

$$Z_m = \frac{V_1}{I_1}, \quad Z_x = \frac{V_2}{I_2}$$

(3) Thus,the relation between Z_x and Z_m is following;

$$Z_x = \alpha \frac{Z_m - \beta}{1 - Z_m \Gamma}$$

where, $\alpha = D / A = 1$
 $\beta = B / D = Z_{sm} - (1 - Y_{om} Z_{sm}) Z_{ss}$
 $\Gamma = C / A = Y_{om}$

- Z_{sm} : measured impedance of short chip
- Z_{ss} : residual impedance of short chip (0.556nH)
- Y_{om} : measured admittance when opening the fixture

(4) L_x shall be calculated with the following equation.

$$L_x = \frac{\text{Im}(Z_x)}{2\pi f}$$

L_x : Inductance of chip coil
 f : Measuring frequency