



Chipsmall Limited consists of a professional team with an average of over 10 year of expertise in the distribution of electronic components. Based in Hongkong, we have already established firm and mutual-benefit business relationships with customers from,Europe,America and south Asia,supplying obsolete and hard-to-find components to meet their specific needs.

With the principle of “Quality Parts,Customers Priority,Honest Operation,and Considerate Service”,our business mainly focus on the distribution of electronic components. Line cards we deal with include Microchip,ALPS,ROHM,Xilinx,Pulse,ON,Everlight and Freescale. Main products comprise IC,Modules,Potentiometer,IC Socket,Relay,Connector.Our parts cover such applications as commercial,industrial, and automotives areas.

We are looking forward to setting up business relationship with you and hope to provide you with the best service and solution. Let us make a better world for our industry!



## Contact us

Tel: +86-755-8981 8866 Fax: +86-755-8427 6832

Email & Skype: info@chipsmall.com Web: www.chipsmall.com

Address: A1208, Overseas Decoration Building, #122 Zhenhua RD., Futian, Shenzhen, China



# Reference Only

## CHIP COIL (CHIP INDUCTORS) LQW18AN□□□□10D REFERENCE SPECIFICATION

### 1.Scope

This reference specification applies to LQW18AN\_10D series, Chip coil(Chip Inductors).

### 2.Part Numbering

(ex)   LQ     W     18     A     N     2N2     D     1     0     D    
 Product ID Structure Dimension Applications Category Inductance Tolerance Features Electrode Packaging  
 (L×W) and Characteristics D:Taping  
 \*B:Bulk

\* Bulk packing also available. (A product is put in the plastic bag under the taping conditions.)

### 3.Rating

- Operating Temperature Range.  $-55^{\circ}\text{C}_{\text{to}} +125^{\circ}\text{C}$
- Storage Temperature Range.  $-55^{\circ}\text{C}_{\text{to}} +125^{\circ}\text{C}$

Customer Part Number	MURATA Part Number	Inductance		Q (min.)	DC Resistance ( $\Omega$ max.)	Self Resonant Frequency (MHz min.)	Rated Current (mA)
		(nH)	Tolerance				
	LQW18AN2N2D10D	2.2	D: $\pm 0.5\text{nH}$	25	0.018	18000	1400
	LQW18AN3N9C10D	3.9	C: $\pm 0.2\text{nH}$	38	0.032	11000	1000
	LQW18AN3N9D10D		D: $\pm 0.5\text{nH}$				
	LQW18AN5N6D10D	5.6	D: $\pm 0.5\text{nH}$		0.045	10000	900
	LQW18AN6N8C10D	6.8	C: $\pm 0.2\text{nH}$				
	LQW18AN6N8D10D		D: $\pm 0.5\text{nH}$				
	LQW18AN8N2D10D	8.2	D: $\pm 0.5\text{nH}$		0.058	7000	800
	LQW18AN10NG10D	10	G: $\pm 2\%$ J: $\pm 5\%$				
	LQW18AN10NJ10D						
	LQW18AN12NG10D	12	G: $\pm 2\%$ J: $\pm 5\%$		0.071	5000	750
	LQW18AN12NJ10D						
	LQW18AN15NJ10D	15	J: $\pm 5\%$	0.085	4500	700	
	LQW18AN18NG10D	18	G: $\pm 2\%$ J: $\pm 5\%$				
	LQW18AN18NJ10D						
	LQW18AN22NG10D	22	G: $\pm 2\%$ J: $\pm 5\%$	0.099	3200	640	
	LQW18AN22NJ10D						
	LQW18AN27NG10D	27	G: $\pm 2\%$ J: $\pm 5\%$	0.116	2800	590	
	LQW18AN27NJ10D						
	LQW18AN33NJ10D	33	J: $\pm 5\%$	0.132	2500	550	

### 4. Testing Conditions

《Unless otherwise specified》

Temperature : Ordinary Temperature /  $15^{\circ}\text{C}$  to  $35^{\circ}\text{C}$   
 Humidity : Ordinary Humidity / 25%(RH) to 85%(RH)

《In case of doubt》

Temperature :  $20^{\circ}\text{C} \pm 2^{\circ}\text{C}$   
 Humidity : 60%(RH) to 70%(RH)  
 Atmospheric Pressure : 86kPa to 106 kPa

### 5. Appearance and Dimensions

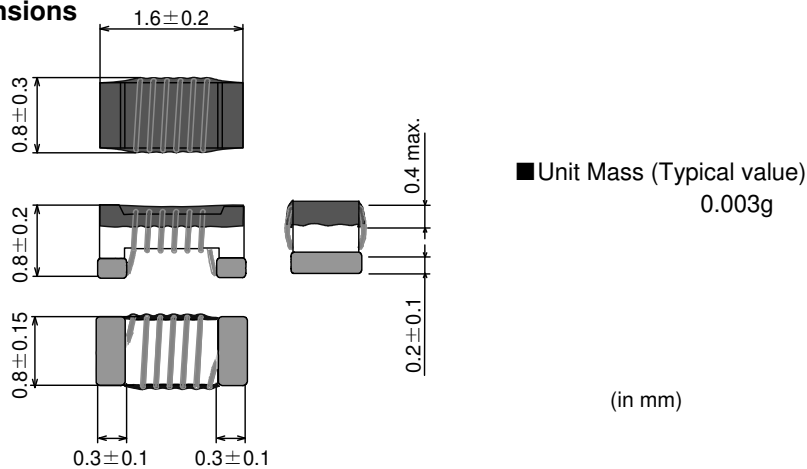

# Reference Only

## 6. Electrical Performance

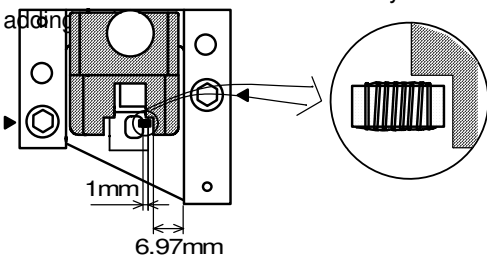
No.	Item	Specification	Test Method
6.1	Inductance	Inductance shall meet item 3.	Measuring Equipment: Agilent 4991A or equivalent Measuring Frequency: <Inductance> 100MHz <Q> 250MHz Measuring Condition: Test signal level / about 0dBm Electrode spaces / 1.0mm Electrical length / 0.94cm Measuring Fixture: Agilent 16193A Position coil under test as shown in below and contact coil with each terminal by
6.2	Q	Q shall meet item 3.	 Measuring Method: See P.9 <Electrical Performance: Measuring Method of Inductance/Q>
6.3	DC Resistance	DC Resistance shall meet item 3.	Measuring Equipment: Digital multi meter
6.4	Self Resonant Frequency(S.R.F)	S.R.F shall meet item 3.	Measuring Equipment: Agilent 5230A or equivalent
6.5	Rated Current	Self temperature rise shall be limited to 20°C max. Inductance Change: within ±10%	The rated current is applied.

## 7. Mechanical Performance

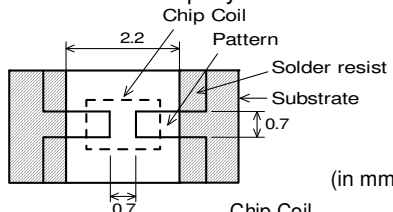
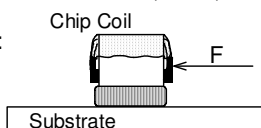
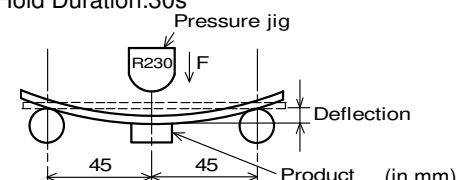
No.	Item	Specification	Test Method
7.1	Shear Test	Chip coil shall not be damaged after tested as test method.	Substrate: Glass-epoxy substrate Chip Coil  Applied Direction:  Force: 5N Hold Duration: 5s±1s
7.2	Bending Test	Chip coil shall not be damaged after tested as test method.	Substrate: Glass-epoxy substrate (100mm × 40mm × 1.6mm) Speed of Applying Force: 1mm / s Deflection: 2mm Hold Duration: 30s 

# Reference Only

No.	Item	Specification	Test Method
7.3	Vibration	Chip coil shall not be damaged after tested as test method.	Oscillation Frequency: 10Hz~55Hz~10Hz for 1 min Total Amplitude:1.5mm Testing Time: A period of 2 hours in each of mutually perpendicular directions.
7.4	Solderability	The wetting area of the electrode shall be at least 90% covered with new solder coating.	Flux:Ethanol solution of rosin,25(wt)% Includes activator equivalent to 0.06(wt)% chlorine.(immersed for 5s to 10s) Solder:Sn-3.0Ag-0.5Cu Pre-Heating:150°C±10°C / 60s to 90s Solder Temperature:240°C±5°C Immersion Time:3s±1s
7.5	Resistance to Soldering Heat	Appearance:No damage Inductance Change: within ±5%	Flux:Ethanol solution of rosin,25(wt)% Includes activator equivalent to 0.06(wt)% Chlorine.(immersed for 5s to 10s) Solder:Sn-3.0Ag-0.5Cu Pre-Heating:150°C±10°C / 60s to 90s Solder Temperature:270°C±5°C Immersion Time:10s±1s Then measured after exposure in the room condition for 24h±2h.

## 8.Environmental Performance

It shall be soldered on the substrate.

No.	Item	Specification	Test Method
8.1	Heat Resistance	Appearance:No damage Inductance Change: within ±5% Q Change: within ±20%	Temperature:125°C±2°C Time:1000h (+48h,0h) Then measured after exposure in the room condition for 24h±2h.
8.2	Cold Resistance		Temperature:-55°C±2°C Time:1000h (+48h,-0h) Then measured after exposure in the room condition for 24h±2 h.
8.3	Humidity		Temperature:40°C±2°C Humidity:90%(RH) to 95%(RH) Time:1000h (+48h,-0h) Then measured after exposure in the room condition for 24h±2h.
8.4	Temperature Cycle		1 cycle: 1 step:-55°C±2°C / 30min±3 min 2 step:Ordinary temp. / 10min to 15 min 3 step:+125°C±2°C / 30min±3 min 4 step:Ordinary temp. / 10min to15 min Total of 10 cycles Then measured after exposure in the room condition for 24h±2h.

## 9.Specification of Packaging

### 9.1 Appearance and Dimensions of paper tape (8mm-wide)

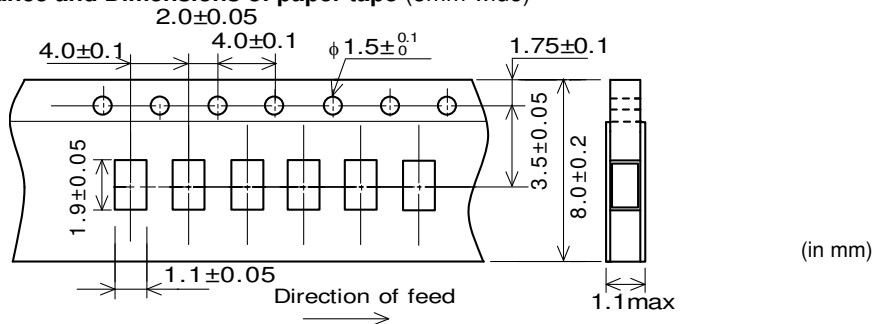

# Reference Only

## 9.2 Specification of Taping

- (1) Packing quantity (standard quantity)  
4,000 pcs. / reel
- (2) Packing Method  
Products shall be packed in the cavity of the base tape and sealed by top tape and bottom tape.
- (3) Sprocket hole  
The sprocket holes are to the right as the tape is pulled toward the user.
- (4) Spliced point  
Base tape and Top tape has no spliced point.
- (5) Missing components number  
Missing components number within 0.1 % of the number per reel or 1 pc., whichever is greater, and are not continuous. The Specified quantity per reel is kept.

## 9.3 Pull Strength

Top tape	5N min.
Bottom tape	

## 9.4 Peeling off force of cover tape

Speed of Peeling off	300mm/min
Peeling off force	0.1N to 0.6N (minimum value is typical)

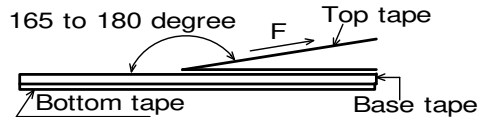

## 9.5 Dimensions of Leader-tape, Trailer and Reel

There shall be leader-tape ( top tape and empty tape) and trailer-tape (empty tape) as follows.

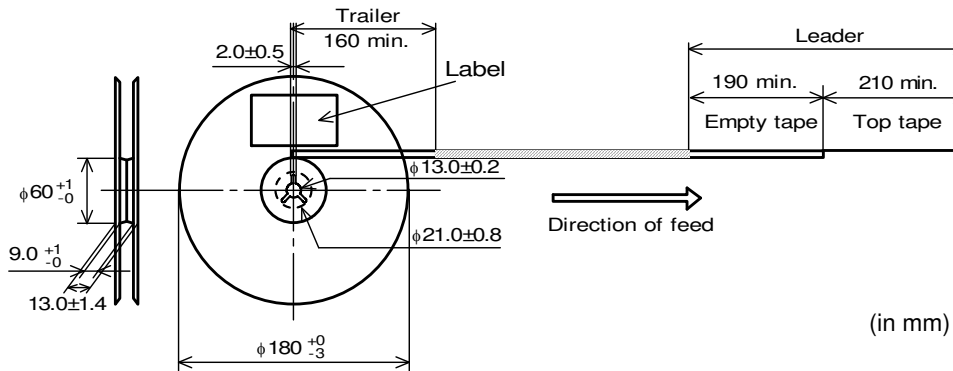

## 9.6 Marking for reel

Customer part number, MURATA part number, Inspection number(\*1) ,RoHS Marking(\*2), Quantity etc ...

\*1) <Expression of Inspection No.>

□□ 0000 XXX  
(1) (2) (3)

(1) Factory Code

(2) Date First digit : Year / Last digit of year

Second digit : Month / Jan. to Sep. → 1 to 9, Oct. to Dec. → O, N, D

Third, Fourth digit : Day

(3) Serial No.

\*2) <Expression of RoHS Marking >

ROHS - Y (Δ)  
(1) (2)

(1) RoHS regulation conformity parts.

(2) MURATA classification number

## 9.7 Marking for Outside package (corrugated paper box)

Customer name, Purchasing order number, Customer part number, MURATA part number, RoHS Marking (\*2) ,Quantity, etc ...

### 9.8. Specification of Outer Case

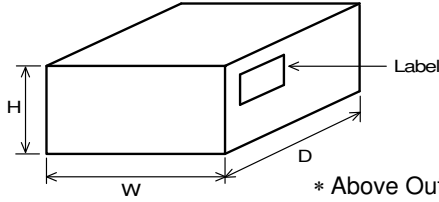

Outer Case Dimensions (mm)			Standard Reel Quantity in Outer Case (Reel)
W	D	H	
186	186	93	5

\* Above Outer Case size is typical. It depends on a quantity of an order.

### 10. ⚠ Caution

#### Limitation of Applications

Please contact us before using our products for the applications listed below which require especially high reliability for the prevention of defects which might directly cause damage to the third party's life, body or property.

- |                                   |  |
|-----------------------------------|--|
| (1) Aircraft equipment            | (6) Transportation equipment (vehicles, trains, ships, etc.)   |
| (2) Aerospace equipment           | (7) Traffic signal equipment   |
| (3) Undersea equipment            | (8) Disaster prevention / crime prevention equipment   |
| (4) Power plant control equipment | (9) Data-processing equipment  |
| (5) Medical equipment             | (10) Applications of similar complexity and /or reliability requirements to the applications listed in the above |

### 11. Notice

Products can only be soldered with reflow.

This product is designed for solder mounting.

Please consult us in advance for applying other mounting method such as conductive adhesive.

#### 11.1 Land pattern designing

Recommended land patterns for reflow soldering are as follows:

These have been designed for Electric characteristics and solderability.

Please follow the recommended patterns. Otherwise, their performance which includes electrical performance or solderability may be affected, or result to "position shift" in soldering process.

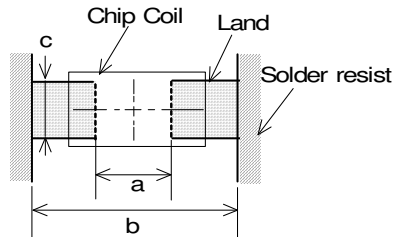

a	0.6 to 0.8
b	1.9 to 2.0
c	0.7 to 1.0

(in mm)

#### 11.2 Flux, Solder

- Use rosin-based flux.

Includes middle activator equivalent to 0.06(wt)% to 0.1(wt) % Chlorine.

Don't use highly acidic flux with halide content exceeding 0.2(wt) % (chlorine conversion value).

Don't use water-soluble flux.

- Use Sn-3.0Ag-0.5Cu solder.

- Standard thickness of solder paste : 100 μm to 150 μm.

### 11.3 Reflow soldering conditions

- Pre-heating should be in such a way that the temperature difference between solder and product surface is limited to 150°C max. Cooling into solvent after soldering also should be in such a way that the temperature difference is limited to 100°C max. Insufficient pre-heating may cause cracks on the product, resulting in the deterioration of products quality.
- Standard soldering profile and the limit soldering profile is as follows. The excessive limit soldering conditions may cause leaching of the electrode and / or resulting in the deterioration of product quality.
- Reflow soldering profile

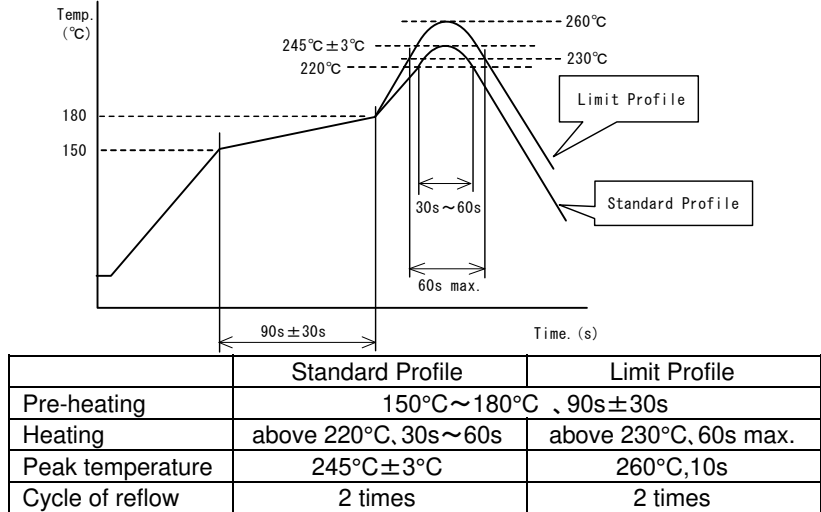

### 11.4 Reworking with soldering iron

The following conditions must be strictly followed when using a soldering iron.

Pre-heating	150°C, 1 min
Tip temperature	350°C max.
Soldering iron output	80W max.
Tip diameter	φ 3mm max.
Soldering time	3(+1, -0)s
Time	2 times

Note :Do not directly touch the products with the tip of the soldering iron in order to prevent the crack on the products due to the thermal shock.

### 11.5 Solder Volume

- Solder shall be used not to be exceeded the upper limits as shown below.
- Accordingly increasing the solder volume, the mechanical stress to Chip is also increased. Exceeding solder volume may cause the failure of mechanical or electrical performance.

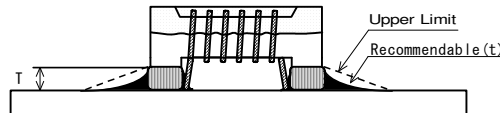

$$1/3T \leq t \leq T$$

T : thickness of product



### 11.6 Product's location

The following shall be considered when designing and laying out P.C.B.'s.

- (1) P.C.B. shall be designed so that products are not subject to the mechanical stress due to warping the board.

[Products direction]

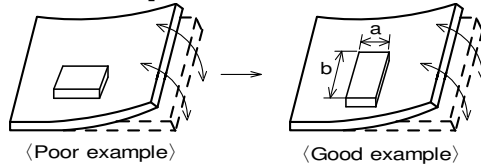

Products shall be located in the sideways direction (Length: $a < b$ ) to the mechanical stress.

- (2) Products location on P.C.B. separation

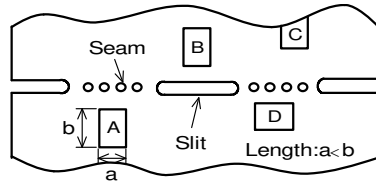

Products (A,B,C,D) shall be located carefully so that products are not subject to the mechanical stress due to warping the board. Because they may be subjected the mechanical stress in order of  $A > C > B \cong D$ .

### 11.7 Cleaning Conditions

Products shall be cleaned on the following conditions.

- (1) Cleaning temperature shall be limited to 60°C max.(40°C max for IPA)
- (2) Ultrasonic cleaning shall comply with the following conditions with avoiding the resonance phenomenon at the mounted products and P.C.B.  
Power : 20 W / l max.    Frequency : 28kHz to 40kHz    Time : 5 min max.
- (3) Cleaner
  1. Alcohol type cleaner  
Isopropyl alcohol (IPA)
  2. Aqueous agent  
PINE ALPHA ST-100S
- (4) There shall be no residual flux and residual cleaner after cleaning.  
In the case of using aqueous agent, products shall be dried completely after rinse with de-ionized water in order to remove the cleaner.
- (5) Other cleaning    Please contact us.

### 11.8 Resin coating

The inductance value may change due to high cure-stress of resin to be used for coating/molding products. An open circuit issue may occur by mechanical stress caused by the resin, amount/cured shape of resin, or operating condition etc. Some resin contains some impurities or chloride possible to generate chlorine by hydrolysis under some operating condition may cause corrosion of wire of coil, leading to open circuit. So, please pay your careful attention when you select resin in case of coating/molding the products with the resin. Prior to use the coating resin, please make sure no reliability issue is observed by evaluating products mounted on your board.

### 11.9 Caution for use

- Sharp material such as a pair of tweezers or other material such as bristles of cleaning brush , shall not be touched to the winding portion to prevent the breaking of wire.
- Mechanical shock should not be applied to the products mounted on the board to prevent the breaking of the core.

### 11.10 Notice of product handling at mounting

In some mounting machines,when picking up components support pin pushes up the components from the bottom of base tape. In this case, please remove the support pin. The support pin may damage the components and break wire.

In rare case ,the laser recognition can not recognize this component. Please contact us when you use laser recognition. (There is no problem with the permeation and reflection type.)



## 11.11 Handling of a substrate

After mounting products on a substrate, do not apply any stress to the product caused by bending or twisting to the substrate when cropping the substrate, inserting and removing a connector from the substrate or tightening screw to the substrate.

Excessive mechanical stress may cause cracking in the product.

Bending

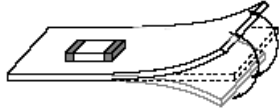

Twisting

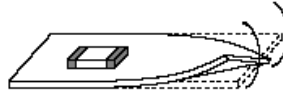

## 11.12 Storage and Handling Requirements

### (1) Storage period

Use the products within 12 months after delivered.

Solderability should be checked if this period is exceeded.

### (2) Storage conditions

•Products should be stored in the warehouse on the following conditions.

Temperature : -10°C to 40°C

Humidity : 15% to 85% relative humidity No rapid change on temperature and humidity

•Don't keep products in corrosive gases such as sulfur, chlorine gas or acid, or it may cause oxidization of electrode, resulting in poor solderability.

•Products should not be stored on bulk packaging condition to prevent the chipping of the core and the breaking of winding wire caused by the collision between the products.

•Products should be stored on the palette for the prevention of the influence from humidity, dust and so on.

•Products should be stored in the warehouse without heat shock, vibration, direct sunlight and so on.

### (3) Handling Condition

Care should be taken when transporting or handling product to avoid excessive vibration or mechanical shock.

## 12. Notes

(1) Please make sure that your product has been evaluated in view of your specifications with our product being mounted to your product.

(2) You are requested not to use our product deviating from the reference specifications.

(3) The contents of this reference specification are subject to change without advance notice.

Please approve our product specifications or transact the approval sheet for product specifications before ordering.

**<Electrical Performance:Measuring Method of Inductance/Q>**

(1) Residual elements and stray elements of test fixture can be described by F-parameter shown in following.

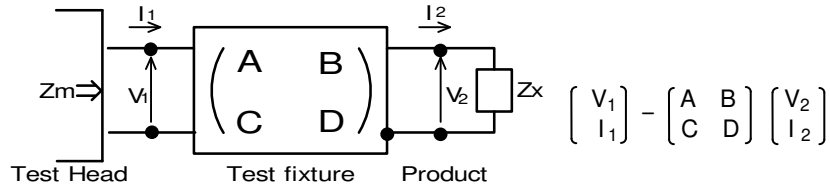

(2) The impedance of chip coil  $Z_x$  and measured value  $Z_m$  can be described by input/output current/voltage.

$$Z_m = \frac{V_1}{I_1} \quad , \quad Z_x = \frac{V_2}{I_2}$$

(3) Thus,the relation between  $Z_x$  and  $Z_m$  is following;

$$Z_x = \alpha \frac{Z_m - \beta}{1 - Z_m \Gamma} \quad \text{where, } \alpha = D / A = 1$$

$$\beta = B / D = Z_{sm} - (1 - Y_{om}) Z_{sm} Z_{ss}$$

$$\Gamma = C / A = Y_{om}$$

$Z_{sm}$ :measured impedance of short chip  
 $Z_{ss}$ :residual impedance of short chip (0.771 nH)  
 $Y_{om}$ :measured admittance when opening the fixture

(4)  $L_x$  and  $Q_x$  shall be calculated with the following equation.

$$L_x = \frac{\text{Im}(Z_x)}{2\pi f} \quad , \quad Q_x = \frac{\text{Im}(Z_x)}{\text{Re}(Z_x)}$$

$L_x$  :Inductance of chip coil  
 $Q_x$ :Q of chip coil  
 $f$  :Measuring frequency