



Chipsmall Limited consists of a professional team with an average of over 10 year of expertise in the distribution of electronic components. Based in Hongkong, we have already established firm and mutual-benefit business relationships with customers from,Europe,America and south Asia,supplying obsolete and hard-to-find components to meet their specific needs.

With the principle of "Quality Parts,Customers Priority,Honest Operation,and Considerate Service",our business mainly focus on the distribution of electronic components. Line cards we deal with include Microchip,ALPS,ROHM,Xilinx,Pulse,ON,Everlight and Freescale. Main products comprise IC,Modules,Potentiometer,IC Socket,Relay,Connector.Our parts cover such applications as commercial,industrial, and automotives areas.

We are looking forward to setting up business relationship with you and hope to provide you with the best service and solution. Let us make a better world for our industry!



Contact us

Tel: +86-755-8981 8866 Fax: +86-755-8427 6832

Email & Skype: info@chipsmall.com Web: www.chipsmall.com

Address: A1208, Overseas Decoration Building, #122 Zhenhua RD., Futian, Shenzhen, China



CHIP COIL (CHIP INDUCTORS) LQW18AN□□□□ 8ZD
Murata Standard Reference Specification 【AEC-Q200】

1.Scope

This reference specification applies to LQW18AN_8ZD series, Chip coil(Chip Inductors) for automotive Electronics based on AEC-Q200 except for Power train and Safety.

2.Part Numbering

(ex)	LQ	W	18	A	N	2N2	C	8	Z	D
	Product ID	Structure	Dimension (L×W)	Applications and Characteristics	Category	Inductance	Tolerance	Features	Application Z:Automotive	Packaging D:Taping

3.Rating

- Operating Temperature Range. -55°C to $+125^{\circ}\text{C}$
- Storage Temperature Range. -55°C to $+125^{\circ}\text{C}$

Customer Part Number	MURATA Part Number	Inductance		Q (min.)	DC Resistance (Ω max.)	Self Resonant Frequency (MHz min.)	Rated Current (mA)	ESD Rank 6: 25kV	
		(nH)	Tolerance						
	LQW18AN2N2C8ZD	2.2	C:±0.2nH	24	0.018	15000	3200	6	
	LQW18AN2N4C8ZD	2.4		18	0.026		2400		
	LQW18AN3N0C8ZD	3.0		13	0.17		670		
	LQW18AN3N9B8ZD	3.9	B:±0.1nH C:±0.2nH G:±2%						
	LQW18AN3N9C8ZD								
	LQW18AN3N9G8ZD								
	LQW18AN4N1B8ZD	4.1			30	0.028	10000		2200
	LQW18AN4N1C8ZD								
	LQW18AN4N1G8ZD								
	LQW18AN4N2B8ZD	4.2							
	LQW18AN4N2C8ZD								
	LQW18AN4N2G8ZD								
	LQW18AN4N3B8ZD	4.3			35	0.036	11600		2100
	LQW18AN4N3C8ZD								
	LQW18AN4N3G8ZD								
	LQW18AN4N7B8ZD	4.7			25	0.054	10400	1500	
	LQW18AN4N7C8ZD								
	LQW18AN4N7G8ZD								
	LQW18AN4N9B8ZD	4.9		23	0.081	7300	1200		
	LQW18AN4N9C8ZD								
	LQW18AN4N9G8ZD								
	LQW18AN5N6C8ZD	5.6	C:±0.2nH G:±2%	38	0.040	6650	1900		
	LQW18AN5N6G8ZD								
	LQW18AN6N0C8ZD	6							
	LQW18AN6N0G8ZD								
	LQW18AN6N5C8ZD	6.5						40	
	LQW18AN6N5G8ZD								
	LQW18AN6N8C8ZD	6.8							
	LQW18AN6N8G8ZD								
	LQW18AN7N2C8ZD	7.2	C:±0.2nH G:±2%	38					
	LQW18AN7N2C8ZD								

Customer Part Number	MURATA Part Number	Inductance		Q (min.)	DC Resistance (Ω max.)	Self Resonant Frequency (MHz min.)	Rated Current (mA)	ESD Rank 6: 25kV
		(nH)	Tolerance					
	LQW18AN7N5C8ZD	7.5	C: \pm 0.2nH G: \pm 2%	35	0.048	7000	1500	6
	LQW18AN7N5G8ZD							
	LQW18AN8N2C8ZD	8.2						
	LQW18AN8N2G8ZD							
	LQW18AN8N4C8ZD	8.4						
	LQW18AN8N4G8ZD							
	LQW18AN8N7C8ZD	8.7						
	LQW18AN8N7G8ZD							
	LQW18AN9N1C8ZD	9.1						
	LQW18AN9N1G8ZD							
	LQW18AN9N5C8ZD	9.5						
	LQW18AN9N5G8ZD							
	LQW18AN9N9C8ZD	9.9						
	LQW18AN9N9G8ZD							
	LQW18AN10NG8ZD	10						
	LQW18AN10NJ8ZD							
	LQW18AN11NG8ZD	11						
	LQW18AN11NJ8ZD							
	LQW18AN12NG8ZD	12						
	LQW18AN12NJ8ZD							
	LQW18AN13NG8ZD	13						
	LQW18AN13NJ8ZD							
	LQW18AN15NG8ZD	15						
	LQW18AN15NJ8ZD							
	LQW18AN16NG8ZD	16						
	LQW18AN16NJ8ZD							
	LQW18AN17NG8ZD	17						
	LQW18AN17NJ8ZD							
	LQW18AN18NG8ZD	18						
	LQW18AN18NJ8ZD							
	LQW18AN19NG8ZD	19						
	LQW18AN19NJ8ZD							
	LQW18AN22NG8ZD	22						
	LQW18AN22NJ8ZD							
	LQW18AN23NG8ZD	23						
	LQW18AN23NJ8ZD							
	LQW18AN24NG8ZD	24						
	LQW18AN24NJ8ZD							
	LQW18AN25NG8ZD	25						
	LQW18AN25NJ8ZD							
	LQW18AN27NG8ZD	27						
	LQW18AN27NJ8ZD							
	LQW18AN28NG8ZD	28						
	LQW18AN28NJ8ZD							
	LQW18AN30NG8ZD	30						
	LQW18AN30NJ8ZD							

Customer Part Number	MURATA Part Number	Inductance		Q (min.)	DC Resistance (Ω max.)	Self Resonant Frequency (MHz min.)	Rated Current (mA)	ESD Rank 6: 25kV
		(nH)	Tolerance					
	LQW18AN31NG8ZD	31	G: \pm 2% J: \pm 5%	40	0.11	3150	1100	6
	LQW18AN31NJ8ZD							
	LQW18AN33NG8ZD	33			0.15	1050		
	LQW18AN33NJ8ZD							
	LQW18AN34NG8ZD	34		37	0.20	3000	910	
	LQW18AN34NJ8ZD							
	LQW18AN36NG8ZD	36		40	0.16	3280	1000	
	LQW18AN36NJ8ZD							
	LQW18AN37NG8ZD	37		0.21	2780	840		
	LQW18AN37NJ8ZD							
	LQW18AN39NG8ZD	39		32	0.23	2700	830	
	LQW18AN39NJ8ZD							
	LQW18AN41NG8ZD	41		35	0.27	2750	750	
	LQW18AN41NJ8ZD							
	LQW18AN43NG8ZD	43		38	0.26	2600	770	
	LQW18AN43NJ8ZD							
	LQW18AN44NG8ZD	44		35	0.30	2400	700	
	LQW18AN44NJ8ZD							
	LQW18AN47NG8ZD	47		37	0.38	2380	630	
	LQW18AN47NJ8ZD							
	LQW18AN48NG8ZD	48	34	0.47	2330	560		
	LQW18AN48NJ8ZD							
	LQW18AN51NG8ZD	51	28	0.41	2280	590		
	LQW18AN51NJ8ZD							
	LQW18AN52NG8ZD	52	34	0.5	2230	550		
	LQW18AN52NJ8ZD							
	LQW18AN56NG8ZD	56	33	0.54	1900	520		
	LQW18AN56NJ8ZD							
	LQW18AN58NG8ZD	58						
	LQW18AN58NJ8ZD							
	LQW18AN68NG8ZD	68						
	LQW18AN68NJ8ZD							
	LQW18AN69NG8ZD	69						
	LQW18AN69NJ8ZD							
	LQW18AN72NG8ZD	72						
	LQW18AN72NJ8ZD							
	LQW18AN73NG8ZD	73						
	LQW18AN73NJ8ZD							
	LQW18AN75NG8ZD	75						
	LQW18AN75NJ8ZD							
	LQW18AN78NG8ZD	78						
	LQW18AN78NJ8ZD							
	LQW18AN82NG8ZD	82						
	LQW18AN82NJ8ZD							
	LQW18AN83NG8ZD	83						
	LQW18AN83NJ8ZD							
	LQW18AN91NG8ZD	91						
	LQW18AN91NJ8ZD							

Customer Part Number	MURATA Part Number	Inductance		Q (min.)	DC Resistance (Ω max.)	Self Resonant Frequency (MHz min.)	Rated Current (mA)	ESD Rank 6: 25kV
		(nH)	Tolerance					
	LQW18AN94NG8ZD	94	G: \pm 2% J: \pm 5%	34	0.63	1750	490	6
	LQW18AN94NJ8ZD							
	LQW18ANR10G8ZD	100		32	0.7	1730	450	
	LQW18ANR10J8ZD							
	LQW18ANR11G8ZD	110		28	0.87	1580	420	
	LQW18ANR11J8ZD							
	LQW18ANR12G8ZD	120		25	1.65	1380	310	
	LQW18ANR12J8ZD							
	LQW18ANR15G8ZD	150		27	1.98	1330	280	
	LQW18ANR15J8ZD							
	LQW18ANR18G8ZD	180		25	2.08	1330	250	
	LQW18ANR18J8ZD							
	LQW18ANR20G8ZD	200		24	2.28	1250	260	
	LQW18ANR20J8ZD							
	LQW18ANR21G8ZD	210		25	3.12	1200	220	
	LQW18ANR21J8ZD							
	LQW18ANR22G8ZD	220		25	3.84	1100	190	
	LQW18ANR22J8ZD							
	LQW18ANR25G8ZD	250		24	3.98	1050	190	
	LQW18ANR25J8ZD							
	LQW18ANR27G8ZD	270	25	4.23	1100	190		
	LQW18ANR27J8ZD							
	LQW18ANR30G8ZD	300	25	3.12	1200	220		
	LQW18ANR30J8ZD							
	LQW18ANR33G8ZD	330	25	3.84	1100	190		
	LQW18ANR33J8ZD							
	LQW18ANR36G8ZD	360	25	3.98	1050	190		
	LQW18ANR36J8ZD							
	LQW18ANR39G8ZD	390	25	4.23	1100	190		
	LQW18ANR39J8ZD							

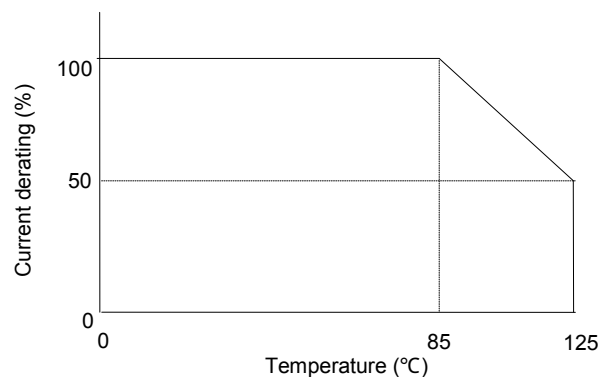

Derating of Rated Current depend on Operating Temperature

4. Testing Conditions

《Unless otherwise specified》

Temperature : Ordinary Temperature / 15°C to 35°C
 Humidity : Ordinary Humidity / 25%(RH) to 85%(RH)

《In case of doubt》

Temperature : 20°C \pm 2°C
 Humidity : 60%(RH) to 70%(RH)
 Atmospheric Pressure : 86kPa to 106 kPa

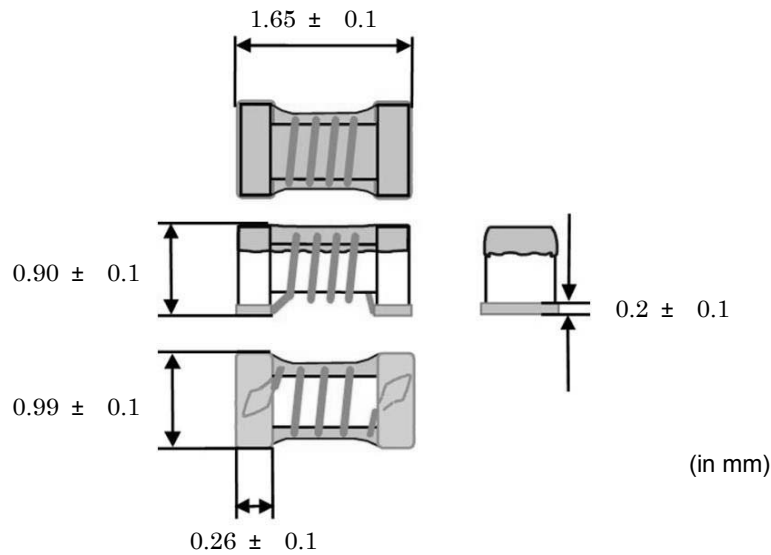
5. Appearance and Dimensions

■ Unit Mass (Typical value)
0.0034g

6. Electrical Performance

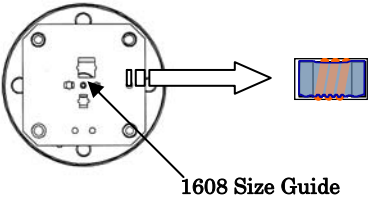
No.	Item	Specification	Test Method
6.1	Inductance	Inductance shall meet item 3.	Measuring Equipment: Agilent 4287A or equivalent Measuring Frequency: <Inductance> 100MHz <Q> 250MHz/ 2.2nH~44nH 200MHz/ 47nH~69nH 150MHz/ 72nH~150nH 100MHz/ 180nH~390nH Measuring Condition: Test signal level / about 10mA Electrical length / 0.94 cm Measuring Fixture: Agilent 16197A
6.2	Q	Q shall meet item 3.	Position coil under test as shown in below and contact coil with each terminal by adding weight.  1608 Size Guide Measuring Method: See P.11 <Electrical Performance: Measuring Method of Inductance/Q>
6.3	DC Resistance	DC Resistance shall meet item 3.	Measuring Equipment: Digital multi meter
6.4	Self Resonant Frequency(S.R.F)	S.R.F shall meet item 3.	Measuring Equipment: Agilent 5230A or equivalent
6.5	Rated Current	Self temperature rise shall be limited to 40°C max.	The rated current is applied.

7. Q200 Requirement**7.1.Performance (based on Table 5 for Magnetics(Inductors / Transformer)****AEC-Q200 Rev.D issued June 1. 2010**

AEC-Q200			Murata Specification / Deviation				
No	Stress	Test Method					
3	High Temperature Exposure	1000hours at 125 deg C Set for 24hours at room temperature, then measured.	Meet Table A after testing. Table A <table border="1" data-bbox="959 296 1386 401"> <tr> <td>Appearance</td> <td>No damage</td> </tr> <tr> <td>Inductance (at 100MHz)</td> <td>Within $\pm 5\%$</td> </tr> </table>	Appearance	No damage	Inductance (at 100MHz)	Within $\pm 5\%$
Appearance	No damage						
Inductance (at 100MHz)	Within $\pm 5\%$						
4	Temperature Cycling	1000cycles -40 deg C to +125 deg C Set for 24hours at room temperature, then measured.	Meet Table A after testing.				
7	Biased Humidity	1000hours at 85 deg C, 85%RH unpowered..	Meet Table A after testing.				
8	Operational Life	Apply Rated Current 125 deg C 1000hours Set for 24hours at room temperature, then measured	Meet Table A after testing.				
9	External Visual	Visual inspection	No abnormalities				
10	Physical Dimension	Meet ITEM 4 (Style and Dimensions)	No defects				
12	Resistance to Solvents	Per MIL-STD-202 Method 215	Not Applicable				
13	Mechanical Shock	Per MIL-STD-202 Method 213 Condition C : 100g's(0.98N), 6ms, Half sine, 12.3ft/s	Meet Table A after testing.				
14	Vibration	5g's(0.049N) for 20 minutes, 12cycles each of 3 orientations Test from 10-2000Hz.	Meet Table A after testing.				
15	Resistance to Soldering Heat	No-heating Solder temperature 260C+/-5 deg C Immersion time 10s	Pre-heating: 150C +/-10 deg C, 60s to 90s Meet Table A after testing.				
17	ESD	Per AEC-Q200-002	ESD Rank: Refer to Item 3. Rating. Meet Table A after testing.				
18	Solderability	Per J-STD-002	Method b : Not Applicable 95% of the terminations is to be soldered. (Except exposed wire)				

AEC-Q200			Murata Specification / Deviation				
No	Stress	Test Method					
19	Electrical Characterization	Measured : Inductance	No defects				
20	Flammability	Per UL-94	Not Applicable				
21	Board Flex	Epoxy-PCB(1.6mm) Deflection 2mm(min) Holding time 60s	Meet Table B after testing. <u>Table B</u> <table border="1" style="margin-left: auto; margin-right: auto; border-collapse: collapse;"> <tr> <td style="padding: 2px;">Appearance</td> <td style="padding: 2px;">No damage</td> </tr> <tr> <td style="padding: 2px;">DC resistance change</td> <td style="padding: 2px;">Within ±10%</td> </tr> </table>	Appearance	No damage	DC resistance change	Within ±10%
Appearance	No damage						
DC resistance change	Within ±10%						
22	Terminal Strength	Per AEC-Q200-006 A force of 17.7N for 60s	Murata Deviation Request: 10N/5s No defect				

8.Specification of Packaging

8.1 Appearance and Dimensions of paper tape (8mm-wide).

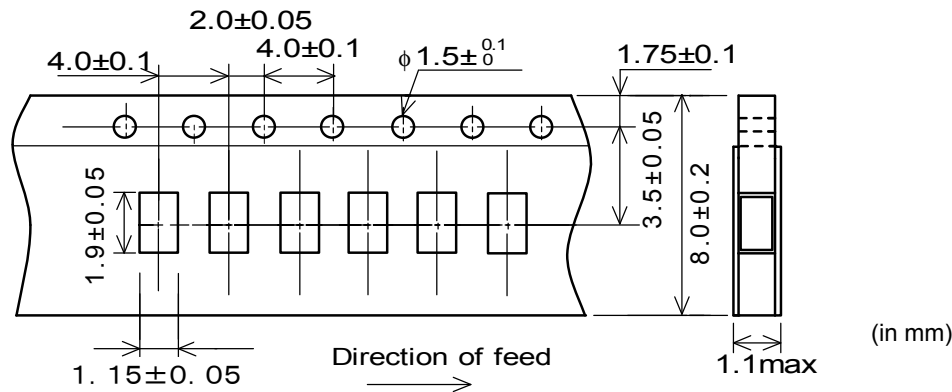

8.2 Specification of Taping

- (1) Packing quantity (standard quantity)
4,000 pcs. / reel
- (2) Packing Method
Products shall be packed in the cavity of the base tape and sealed by top tape and bottom tape.
- (3) Sprocket hole
The sprocket holes are to the right as the tape is pulled toward the user.
- (4) Spliced point
Base tape and Top tape has no spliced point.
- (5) Missing components number
Missing components number within 0.1 % of the number per reel or 1 pc., whichever is greater, and are not continuous. The Specified quantity per reel is kept.

8.3 Pull Strength

Top tape	5N min.
Bottom tape	

8.4 Peeling off force of cover tape

Speed of Peeling off	300mm/min
Peeling off force	0.1N to 0.6N (minimum value is typical)

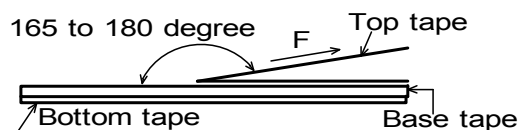

8.5 Dimensions of Leader-tape,Trailer and Reel

There shall be leader-tape (top tape and empty tape) and trailer-tape (empty tape) as follows.

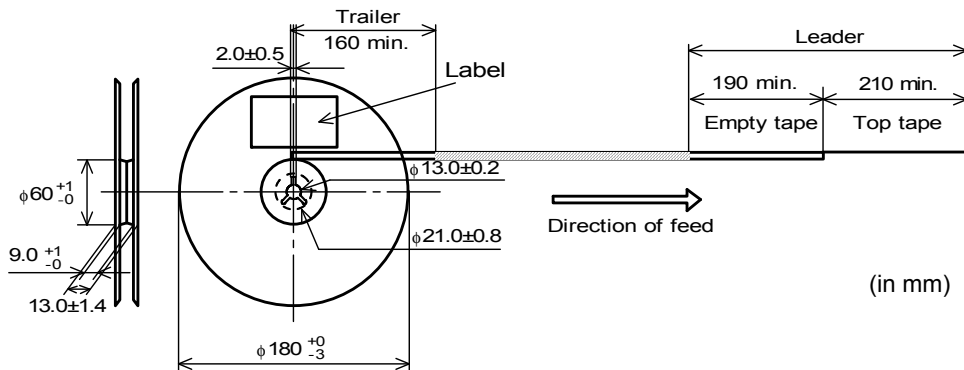

8.6 Marking for reel

Customer part number, MURATA part number, Inspection number(*1) ,RoHS Marking (*2), Quantity etc ...

*1) <Expression of Inspection No.>

$\square\square$ OOOO XXX
 (1) (2) (3)

- (1) Factory code
- (2) Date First digit: Year / Last digit of year
 Second digit: Month / Jan. to Sep. → 1 to 9, Oct. to Dec. → O, N, D
 Third, Fourth digit : Day
- (3) Serial No.

*2) <Expression of RoHS Marking >

ROHS - Y (△)
 (1) (2)

- (1) RoHS regulation conformity parts.
- (2) MURATA classification number

8.7 Marking for Outside package (corrugated paper box)

Customer name, Purchasing order number, Customer part number, MURATA part number, RoHS Marking (*2) ,Quantity, etc ...

8.8. Specification of Outer Case

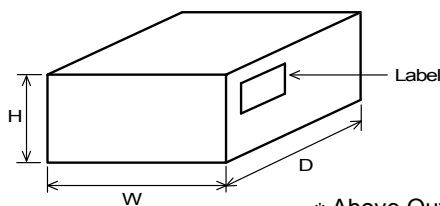

Outer Case Dimensions (mm)			Standard Reel Quantity in Outer Case (Reel)
W	D	H	
186	186	93	5

* Above Outer Case size is typical. It depends on a quantity of an order.

9. ⚠ Caution**9.1 Rating**

Do not exceed maximum rated current of the product. Thermal stress may be transmitted to the product and short/open circuit of the product or falling off the product may be occurred.

9.2 Surge current

Excessive surge current (pulse current or rush current) than specified rated current applied to the product may cause a critical failure, such as an open circuit, burnout caused by excessive temperature rise. Please contact us in advance in case of applying the surge current.

9.3 Fail-safe

Be sure to provide an appropriate fail-safe function on your product to prevent a second damage that may be caused by the abnormal function or the failure of our product.

9.4 Limitation of Applications

Please contact us before using our products for the applications listed below which require especially high reliability for the prevention of defects which might directly cause damage to the third party's life, body or property.

- | | |
|-----------------------------------|--|
| (1) Aircraft equipment | (6) Transportation equipment (trains, ships, etc.) |
| (2) Aerospace equipment | (7) Traffic signal equipment |
| (3) Undersea equipment | (8) Disaster prevention / crime prevention equipment |
| (4) Power plant control equipment | (9) Data-processing equipment |
| (5) Medical equipment | (10) Applications of similar complexity and /or reliability requirements to the applications listed in the above |

10. Notice

Products can only be soldered with reflow.

This product is designed for solder mounting.

Please consult us in advance for applying other mounting method such as conductive adhesive.

10.1 Land pattern designing

Recommended land patterns for reflow soldering are as follows:

These have been designed for Electric characteristics and solderability.

Please follow the recommended patterns. Otherwise, their performance which includes electrical performance or solderability may be affected, or result to "position shift" in soldering process.

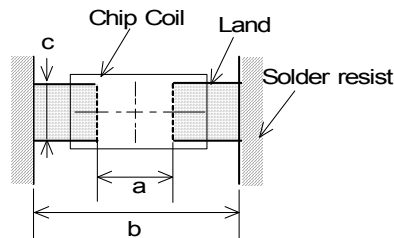

a	0.86
b	2.00
c	1.15

(in mm)

10.2 Flux, Solder

- Use rosin-based flux.
Includes middle activator equivalent to 0.06(wt)% to 0.1(wt)% Chlorine.
Don't use highly acidic flux with halide content exceeding 0.2(wt)% (chlorine conversion value).
Don't use water-soluble flux.
- Use Sn-3.0Ag-0.5Cu solder.
- Standard thickness of solder paste : 100μ m to 150μ m.

10.3 Reflow soldering conditions

- Pre-heating should be in such a way that the temperature difference between solder and product surface is limited to 150°C max. Cooling into solvent after soldering also should be in such a way that the temperature difference is limited to 100°C max.
Insufficient pre-heating may cause cracks on the product, resulting in the deterioration of products quality.
- Standard soldering profile and the limit soldering profile is as follows.
The excessive limit soldering conditions may cause leaching of the electrode and / or resulting in the deterioration of product quality.

• Reflow soldering profile

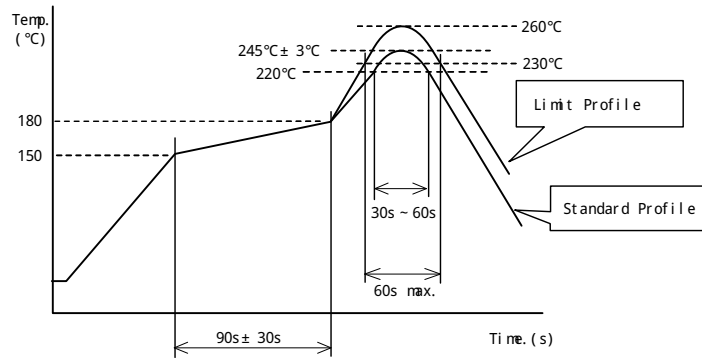

	Standard Profile	Limit Profile
Pre-heating	150°C~180°C , 90s±30s	
Heating	above 220°C, 30s~60s	above 230°C, 60s max.
Peak temperature	245°C±3°C	260°C, 10s
Cycle of reflow	2 times	2 times

10.4 Reworking with soldering iron

The following conditions must be strictly followed when using a soldering iron.

Pre-heating	150°C, 1 min
Tip temperature	350°C max.
Soldering iron output	80W max.
Tip diameter	φ 3mm max.
Soldering time	3(+1,-0)s
Time	2 times

Note :Do not directly touch the products with the tip of the soldering iron in order to prevent the crack on the products due to the thermal shock.

10.5 Solder Volume

- Solder shall be used not to be exceeded the upper limits as shown below.
- Accordingly increasing the solder volume, the mechanical stress to Chip is also increased. Exceeding solder volume may cause the failure of mechanical or electrical performance.

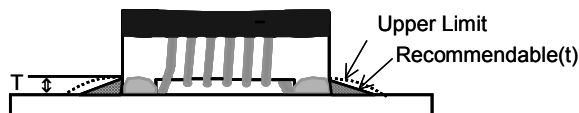

$$1/3T \leq t \leq T$$

T : thickness of product

10.6 Product's location

The following shall be considered when designing and laying out P.C.B.'s.

- (1) P.C.B. shall be designed so that products are not subject to the mechanical stress due to warping the board.

[Products direction]

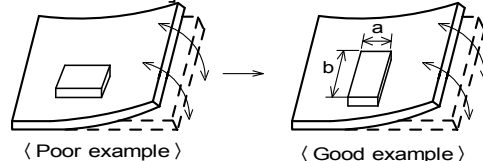

Products shall be located in the sideways direction (Length:a < b) to the mechanical stress.

- (2) Products location on P.C.B. separation

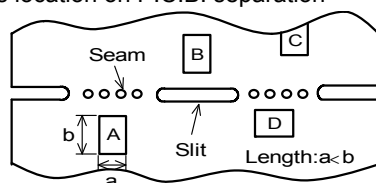

Products (A,B,C,D) shall be located carefully so that products are not subject to the mechanical stress due to warping the board. Because they may be subjected the mechanical stress in order of A > C > B ≅ D.

10.7 Cleaning Conditions

Products shall be cleaned on the following conditions.

- (1) Cleaning temperature shall be limited to 60°C max.(40°C max for IPA)
- (2) Ultrasonic cleaning shall comply with the following conditions with avoiding the resonance phenomenon at the mounted products and P.C.B.
Power : 20 W / l max. Frequency : 28kHz to 40kHz Time : 5 min max.
- (3) Cleaner
 1. Alcohol type cleaner
Isopropyl alcohol (IPA)
 2. Aqueous agent
PINE ALPHA ST-100S
- (4) There shall be no residual flux and residual cleaner after cleaning.
In the case of using aqueous agent, products shall be dried completely after rinse with de-ionized water in order to remove the cleaner.
- (5) Other cleaning Please contact us.

10.8 Resin coating

The inductance value may change due to high cure-stress of resin to be used for coating/molding products. An open circuit issue may occur by mechanical stress caused by the resin, amount/cured shape of resin, or operating condition etc. Some resin contains some impurities or chloride possible to generate chlorine by hydrolysis under some operating condition may cause corrosion of wire of coil, leading to open circuit. So, please pay your careful attention in when you select resin in case of coating/molding the products with the resin.

Prior to use the coating resin, please make sure no reliability issue is observed by evaluating products mounted on your board.

10.9 Caution for use

- Sharp material such as a pair of tweezers or other material such as bristles of cleaning brush , shall not be touched to the winding portion to prevent the breaking of wire.
- Mechanical shock should not be applied to the products mounted on the board to prevent the breaking of the core.

10.10 Notice of product handling at mounting

In some mounting machines,when picking up components support pin pushes up the components from the bottom of base tape. In this case, please remove the support pin. The support pin may damage the components and break wire.

In rare case ,the laser recognition can not recognize this component. Please contact us when you use laser recognition. (There is no problem with the permeation and reflection type.)

10.11 Handling of a substrate

After mounting products on a substrate, do not apply any stress to the product caused by bending or twisting to the substrate when cropping the substrate, inserting and removing a connector from the substrate or tightening screw to the substrate.

Excessive mechanical stress may cause cracking in the product.

Bending

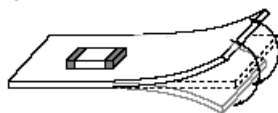

Twisting

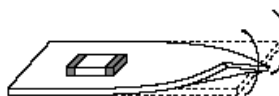

10.12 Storage and Handling Requirements

(1) Storage period

Use the products within 12 months after delivered.
Solderability should be checked if this period is exceeded.

(2) Storage conditions

- Products should be stored in the warehouse on the following conditions.
 - Temperature : -10°C to 40°C
 - Humidity : 15% to 85% relative humidity No rapid change on temperature and humidity
- Don't keep products in corrosive gases such as sulfur, chlorine gas or acid, or it may cause oxidization of electrode, resulting in poor solderability.
- Products should not be stored on bulk packaging condition to prevent the chipping of the core and the breaking of winding wire caused by the collision between the products.
- Products should be stored on the palette for the prevention of the influence from humidity, dust and so on.
- Products should be stored in the warehouse without heat shock, vibration, direct sunlight and so on.

(3) Handling Condition

Care should be taken when transporting or handling product to avoid excessive vibration or mechanical shock.

11. ⚠ Note

- (1) Please make sure that your product has been evaluated in view of your specifications with our product being mounted to your product.
- (2) You are requested not to use our product deviating from the reference specifications.
- (3) The contents of this reference specification are subject to change without advance notice.
Please approve our product specifications or transact the approval sheet for product specifications before ordering.

<Electrical Performance: Measuring Method of Inductance / Q>

(1) Residual elements and stray elements of test fixture can be described by F-parameter shown in following.

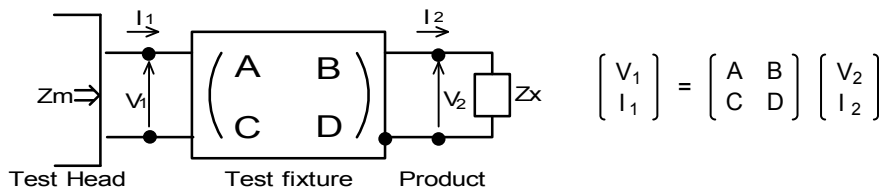

(2) The impedance of chip coil Z_x and measured value Z_m can be described by input/output current/voltage.

$$Z_m = \frac{V_1}{I_1}, \quad Z_x = \frac{V_2}{I_2}$$

(3) Thus, the relation between Z_x and Z_m is following;

$$Z_x = \alpha \frac{Z_m - \beta}{1 - Z_m \Gamma} \quad \text{where, } \alpha = D / A = 1$$

$$\beta = B / D = Z_{sm} - (1 - Y_{om} Z_{sm}) Z_{ss}$$

$$\Gamma = C / A = Y_{om}$$

Z_{sm} : measured impedance of short chip
 Z_{ss} : residual impedance of short chip (0.771nH)
 Y_{om} : measured admittance when opening the fixture

(4) L_x shall be calculated with the following equation.

$$L_x = \frac{\text{Im}(Z_x)}{2\pi f}, \quad Q_x = \frac{\text{Im}(Z_x)}{\text{Re}(Z_x)} \quad \begin{array}{l} L_x : \text{Inductance of chip coil} \\ Q_x : \text{Q of chip coil} \\ f : \text{Measuring frequency} \end{array}$$