



Chipsmall Limited consists of a professional team with an average of over 10 year of expertise in the distribution of electronic components. Based in Hongkong, we have already established firm and mutual-benefit business relationships with customers from,Europe,America and south Asia,supplying obsolete and hard-to-find components to meet their specific needs.

With the principle of “Quality Parts,Customers Priority,Honest Operation,and Considerate Service”,our business mainly focus on the distribution of electronic components. Line cards we deal with include Microchip,ALPS,ROHM,Xilinx,Pulse,ON,Everlight and Freescale. Main products comprise IC,Modules,Potentiometer,IC Socket,Relay,Connector.Our parts cover such applications as commercial,industrial, and automotives areas.

We are looking forward to setting up business relationship with you and hope to provide you with the best service and solution. Let us make a better world for our industry!



Contact us

Tel: +86-755-8981 8866 Fax: +86-755-8427 6832

Email & Skype: info@chipsmall.com Web: www.chipsmall.com

Address: A1208, Overseas Decoration Building, #122 Zhenhua RD., Futian, Shenzhen, China



6-lead MULTILED

Enhanced optical Power LED (ThinFilm / ThinGaN)

Lead (Pb) Free Product - RoHS Compliant

LRTB G6SG



Vorläufige Daten nach OS-PCN-2006-006-A1-B /
Preliminary Data acc. to OS-PCN-2006-006-A1-B

Besondere Merkmale

- **Gehäusetyp:** weißes P-LCC-6 Gehäuse, (RGB-Displays) und diffussem Silikon Verguss
- **Besonderheit des Bauteils:** additive Farbmischung durch unabhängige Ansteuerung aller Chips
- **Wellenlänge:** 625 nm (rot), 528 nm (true green), 458 nm (blau)
- **Abstrahlwinkel:** Lambertscher Strahler (120°)
- **Technologie:** ThinFilm (rot), ThinGaN (true green, blau)
- **optischer Wirkungsgrad:** 43 lm/W (rot), 36 lm/W (true green), 11 lm/W (blau)
- **Gruppierungsparameter:** Lichtstärke, Wellenlänge
- **Verarbeitungsmethode:** für alle SMT-Bestücktechniken geeignet
- **Lötmethode:** Reflow Löten
- **Vorbehandlung:** nach JEDEC Level 4
- **Gurtung:** 12 mm Gurt mit 1000/Rolle, ø180 mm oder 4000/Rolle, ø330 mm
- **ESD-Festigkeit:** ESD-sensitives Bauteil

Anwendungen

- Anzeigen im Innen- und Außenbereich (z.B. im Verkehrsbereich; Laufschriftanzeigen)
- Getrennte Antsteuerung der Leuchtdiodenchips zur Darstellung verschiedener Farben inklusive weiß
- Vollfarbdisplays bzw. RGB-Displays
- Blitzlicht im Handy
- Hinterleuchtung (LCD, Schalter, Tasten, Werbebeleuchtung, Allgemeinbeleuchtung)
- Einkopplung in Lichtleiter

Features

- **package:** white P-LCC-6 package, diffused silicone resin
- **feature of the device:** additive mixture of color stimuli by independent driving of each chip
- **wavelength:** 625 nm (red), 528 nm (true green), 458 nm (blue)
- **viewing angle:** Lambertian Emitter (120°)
- **technology:** ThinFilm (red), ThinGaN (true green, blue)
- **optical efficiency:** 43 lm/W (red), 36 lm/W (true green), 11 lm/W (blue)
- **grouping parameter:** luminous intensity, wavelength
- **assembly methods:** suitable for all SMT assembly methods
- **soldering methods:** reflow soldering
- **preconditioning:** acc. to JEDEC Level 4
- **taping:** 12 mm tape with 1000/reel, ø180 mm or 4000/reel, ø330 mm
- **ESD-withstand voltage:** ESD sensitive Device

Applications

- indoor and outdoor displays (e.g. displays for traffic; light writing displays)
- LED chips can be controlled separately to display various colors including white
- full color displays, RGB-Displays
- strobe light for cellular phones
- backlighting (LCD, switches, keys, illuminated advertising, general lighting)
- coupling into light guides

Bestellinformation
Ordering Information

Typ	Emissionsfarbe	Lichtstärke ¹⁾ Seite 23		
Type	Color of Emission	Luminous Intensity ¹⁾ page 23		
		$I_F = 20 \text{ mA}$		
		$I_V \text{ (mcd)}$		
		red	true green	blue
LRTB G6SG	red true green blue	502 ...1400	900 ...2500	180 ...900

Bestellinformation
Ordering Information

Typ	Bestellnummer
Type	Ordering Code
LRTB G6SG-U4AA-1+V2B4-25+S1U2-35	Q65110A9417
LRTB G6SG-U4AA-1+V2B4-25+S1V1-68	Q65110A9441

*Anm: Die oben genannten Typbezeichnungen umfassen die bestellbaren Selektionen. Diese bestehen aus wenigen Helligkeitsgruppen (siehe **Seite 7** für nähere Informationen). Es wird nur eine einzige Helligkeitsgruppe pro Gurt geliefert. Z.B.: LRTB G6SG-U4AA-1+V2B4-25+S1V1-68 bedeutet, dass auf dem Gurt nur eine der Helligkeitsgruppen U4, U2, U6, V1, V4, V2, V6 oder AA enthalten ist. Um die Liefersicherheit zu gewährleisten, können einzelne Helligkeitsgruppen nicht bestellt werden.*

*Gleiches gilt für die Farben, bei denen Wellenlängengruppen gemessen und gruppiert werden. Pro Gurt wird nur eine Wellenlängengruppe geliefert. Z.B.: LRTB G6SG-U4AA-1+V2B4-25+S1V1-68 bedeutet, dass auf dem Gurt nur eine der Wellenlängengruppen -2, -3, -4, oder -5 enthalten ist (siehe **Seite 8** für nähere Information). Z.B.: LRTB G6SG-U4AA-1+V2B4-25+S1V1-68 bedeutet, dass das Bauteil innerhalb der auf **Seite 4** spezifizierten Grenzen geliefert wird. Um die Liefersicherheit zu gewährleisten, können einzelne Wellenlängengruppen nicht bestellt werden.*

*Note: The above Type Numbers represent the order groups which include only a few brightness groups (see **page 7** for explanation). Only one group will be shipped on each reel (there will be no mixing of two groups on each reel). E.g. LRTB G6SG-U4AA-1+V2B4-25+S1V1-68 means that only one group U4, U2, U6, V1, V4, V2, V6 or AA will be shippable for any one reel. In order to ensure availability, single brightness groups will not be orderable.*

*In a similar manner for colors where wavelength groups are measured and binned, single wavelength groups will be shipped on any one reel. E.g. LRTB G6SG-U4AA-1+V2B4-25+S1V1-68 means that only 1 wavelength group -2, -3, -4, or -5 will be shippable (see **page 8** for explanation). E.g. LRTB G6SG-U4AA-1+V2B4-25+S1V1-68 means that the device will be shipped within the specified limits as stated on **page 4**. In order to ensure availability, single wavelength groups will not be orderable.*

Grenzwerte
Maximum Ratings

Bezeichnung Parameter	Symbol Symbol	Werte Values			Einheit Unit
		red	true green	blue	
Betriebstemperatur Operating temperature range	T_{op}	- 40 ... + 110			°C
Lagertemperatur Storage temperature range	T_{stg}	- 40 ... + 110			°C
Sperrschichttemperatur Junction temperature	T_j	+ 125			°C
Durchlassstrom Forward current ($T_A=25^\circ\text{C}$)	I_F	70	50		mA
Stoßstrom Surge current $t_p = 10 \mu\text{s}$, $D = 0.005$, $T_A=25^\circ\text{C}$	I_{FM}	100	300	300	mA
Sperrspannung ^{2) Seite 23} Reverse voltage ^{2) page 23} ($T_A=25^\circ\text{C}$)	V_R	12	5		V
Leistungsaufnahme Power consumption ($T_A=25^\circ\text{C}$)	P_{tot}	195	210		mW
Wärmewiderstand Thermal resistance Sperrschicht/Umgebung ^{3) Seite 23} Junction/ambient ^{3) page 23} Sperrschicht/Löt看 Junction/solder point					
	1 chip on $R_{th JA}$	340	340	340	K/W
	3 chips on $R_{th JA}$	600	600	600	K/W
	$R_{th JS}$	180	180	180	K/W

Kennwerte
Characteristics
 $(T_A = 25\text{ °C})$

Bezeichnung Parameter	Symbol Symbol	Werte Values			Einheit Unit
		red	true green	blue	
Wellenlänge des emittierten Lichtes Wavelength at peak emission $I_F = 20\text{ mA}$	(typ.) λ_{peak}	632	523	453	nm
Dominantwellenlänge ⁴⁾ Seite 23 Dominant wavelength ⁴⁾ page 23 $I_F = 20\text{ mA}$	(min.) λ_{dom} (typ.) (max.)	620.0 625 629.0	518.5 528 541.5	448.5 458 472.5	nm nm nm
Spektrale Bandbreite bei 50 % $I_{\text{rel max}}$ Spectral bandwidth at 50 % $I_{\text{rel max}}$ $I_F = 20\text{ mA}$	(typ.) $\Delta\lambda$	18	33	25	nm
Abstrahlwinkel bei 50 % I_V (Vollwinkel) Viewing angle at 50 % I_V	(typ.) 2φ	120	120	120	Grad deg.
Durchlassspannung ⁵⁾ Seite 23 Forward voltage ⁵⁾ page 23 $I_F = 20\text{ mA}$	(min.) V_F (typ.) (max.) V_F	1.8 2.1 2.4	2.9 3.2 3.7	2.9 3.2 3.7	V V V
Sperrstrom Reverse current $V_R = 5\text{ V}$ (blue / true green); 12 V (red)	(typ.) I_R (max.) I_R	0.02 10	0.01 10	0.01 10	μA μA
Temperaturkoeffizient von λ_{peak} Temperature coefficient of λ_{peak} $I_F = 20\text{ mA}$; $-10\text{ °C} \leq T \leq 100\text{ °C}$	(typ.) $TC_{\lambda_{\text{peak}}}$	0.14	0.04	0.04	nm/K
Temperaturkoeffizient von λ_{dom} Temperature coefficient of λ_{dom} $I_F = 20\text{ mA}$; $-10\text{ °C} \leq T \leq 100\text{ °C}$	(typ.) $TC_{\lambda_{\text{dom}}}$	0.07	0.03	0.02	nm/K
Temperaturkoeffizient von V_F Temperature coefficient of V_F $I_F = 20\text{ mA}$; $-10\text{ °C} \leq T \leq 100\text{ °C}$	(typ.) TC_V	- 4.7	- 3.6	- 4.0	mV/K
Optischer Wirkungsgrad Optical efficiency $I_F = 20\text{ mA}$	(typ.) η_{opt}	43	36	11	lm/W

* Einzelgruppen siehe Seite 8
Individual groups on page 8

Farbortgruppen^{6) 7)} Seite 23

Chromaticity Coordinate Groups^{6) 7)} page 23

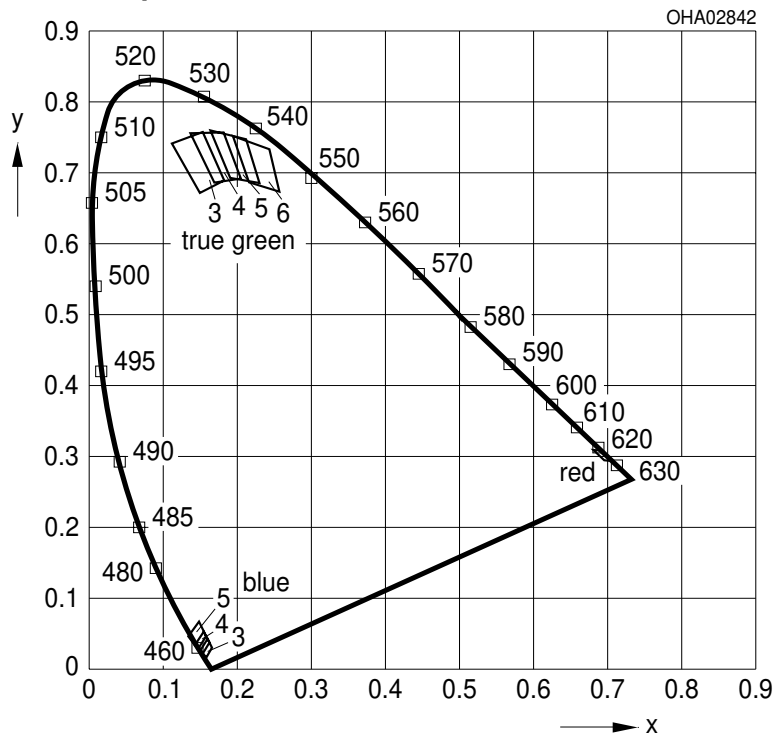

Gruppe Group	Cx	Cy	Gruppe Group	Cx	Cy
3	0.112	0.741	3	0.158	0.017
	0.150	0.672		0.166	0.030
	0.182	0.689		0.160	0.043
	0.153	0.757		0.150	0.026
4	0.137	0.756	4	0.153	0.022
	0.169	0.686		0.162	0.038
	0.205	0.692		0.155	0.053
	0.181	0.757		0.143	0.034
5	0.164	0.760	5	0.147	0.028
	0.190	0.693		0.158	0.047
	0.230	0.686		0.148	0.067
	0.212	0.747		0.134	0.046
6	0.194	0.752	red	0.692	0.308
	0.216	0.687		0.681	0.309
	0.257	0.673		0.695	0.295
	0.243	0.733		0.707	0.293

Anm.: Die Farbkoordinaten des Mischlichtes können innerhalb des gekennzeichneten Bereichs des Farbdreiecks erwartet werden.

Note: The color coordinates of the mixed light can be expected within the marked area of the color triangle

Floating Bins

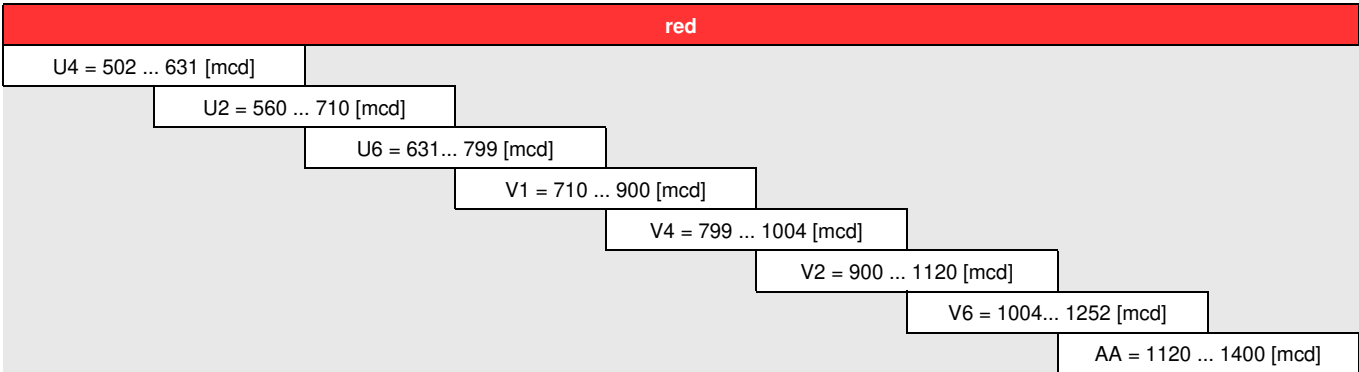

Floating Bins

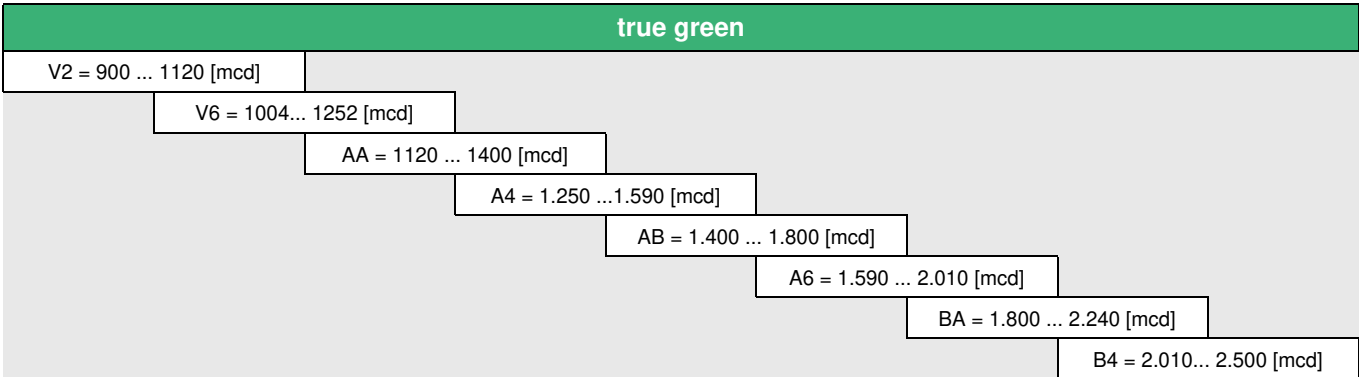

Floating Bins

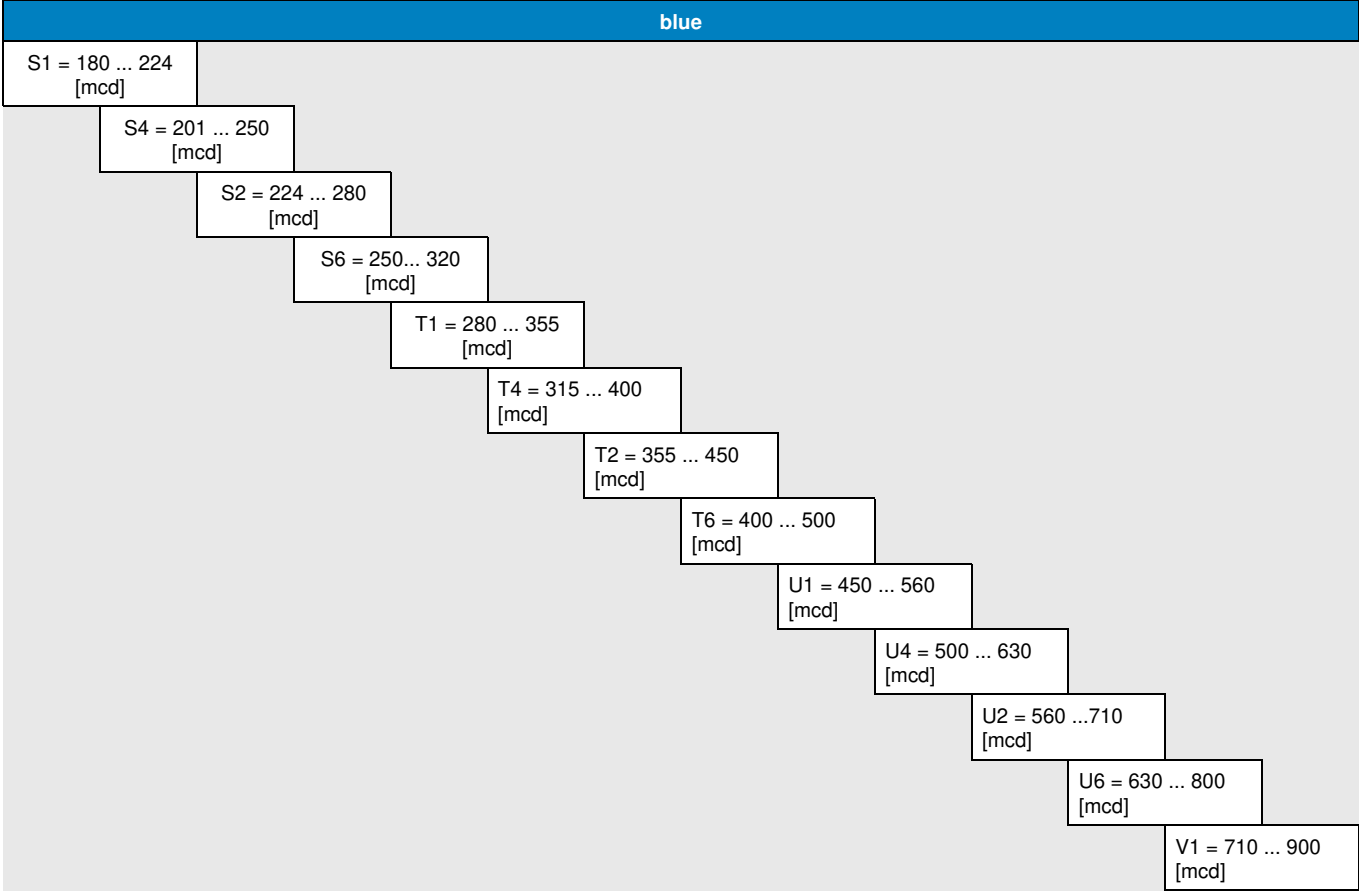

Wellenlängengruppen (Dominantwellenlänge)⁴⁾ Seite 23
Wavelength Groups (Dominant Wavelength)⁴⁾ page 23

Gruppe Group	true green		Einheit Unit
	min.	max.	
3	518.5	526.5	nm
4	523.5	531.5	nm
5	528.5	536.5	nm
6	533.5	541.5	nm

Gruppe Group	blue		Einheit Unit
	min.	max.	
3	448.5	456.5	nm
4	453.5	461.5	nm
5	458.5	466.5	nm
6	463.5	467.5	nm
7	467.5	471.0	nm
8	468.5	472.5	nm

Gruppenbezeichnung auf Etikett
Group Name on Label

Beispiel: T2-1+U2-4+R2-7

Example: T2-1+U2-4+R2-7

Helligkeits- gruppe Brightness Group (red)	Wellenlänge (keine Gruppierung) Wavelength (no grouping) (red)	Helligkeits- gruppe Brightness Group (true green)	Wellenlänge Wavelength (true green)	Helligkeits- gruppe Brightness Group (blue)	Wellenlänge Wavelength (blue)
T2	1	U2	4	R2	7

Anm.: In einer Verpackungseinheit / Gurt ist immer nur eine Helligkeitsgruppe pro Farbe enthalten.

Note: No packing unit / tape ever contains more than one brightness group per color.

Relative spektrale Emission^{6) Seite 23}

Relative Spectral Emission^{6) page 23}

$V(\lambda)$ = spektrale Augenempfindlichkeit / Standard eye response curve

$I_{rel} = f(\lambda); T_A = 25\text{ °C}; I_F = 20\text{ mA}$

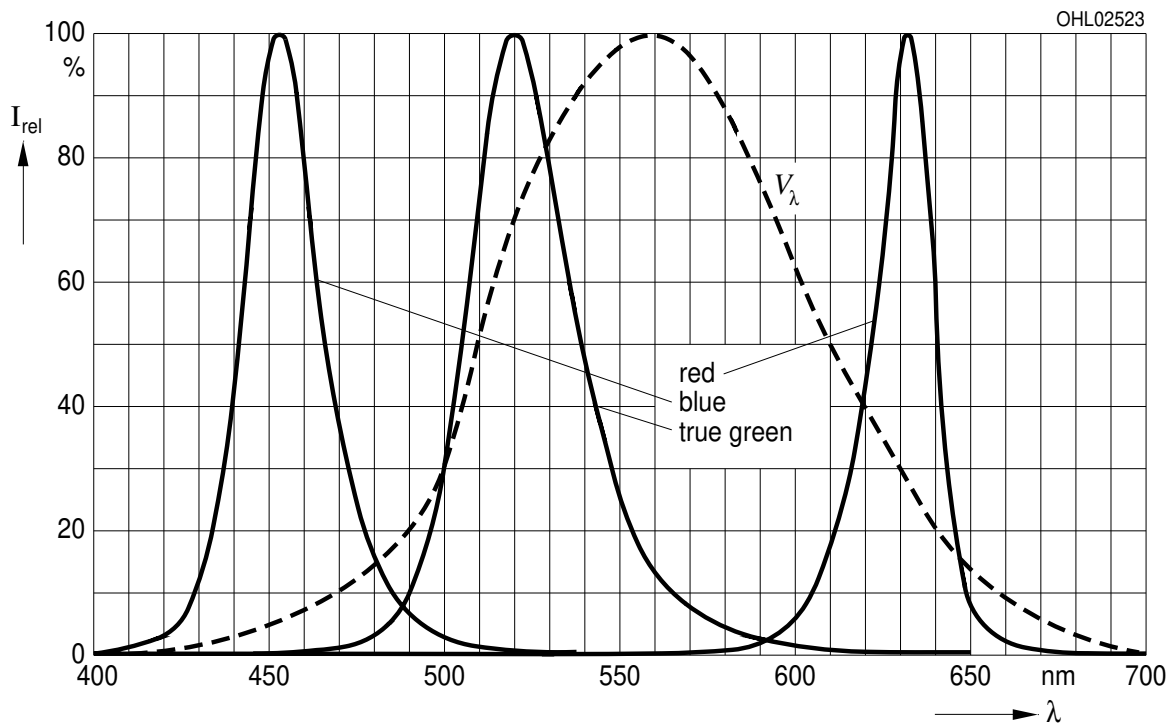

Abstrahlcharakteristik^{6) Seite 23}

Radiation Characteristic^{6) page 23}

$I_{rel} = f(\varphi); T_A = 25\text{ °C}$

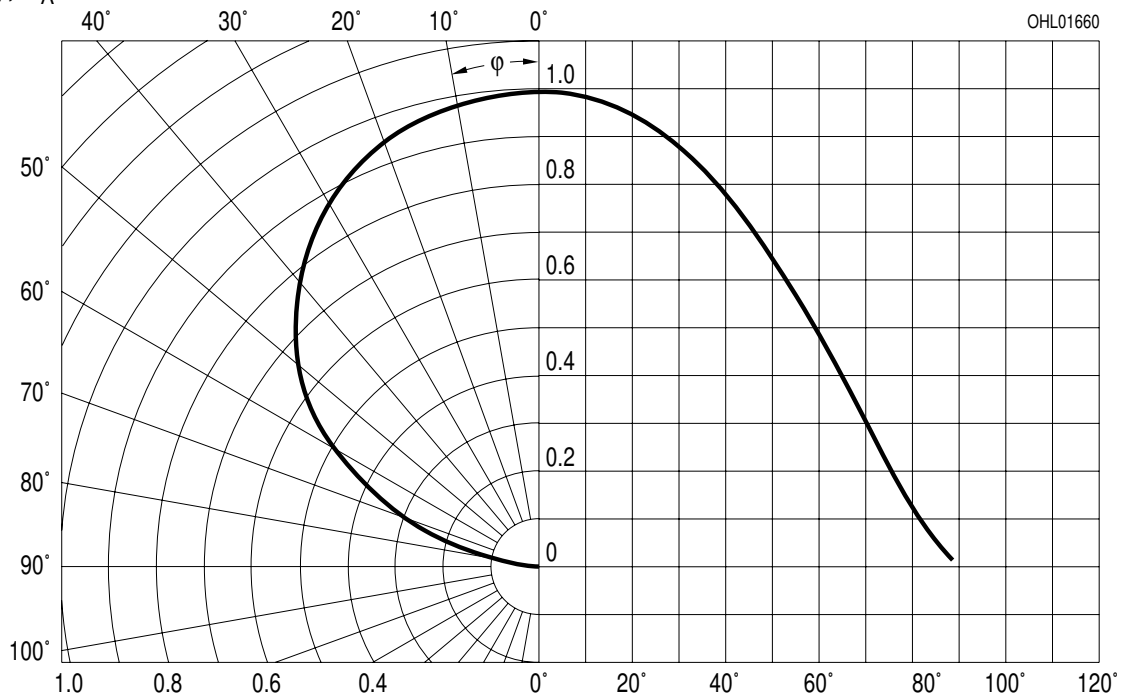

Durchlassstrom⁶⁾ Seite 23

Forward Current⁶⁾ page 23

$I_F = f(V_F); T_A = 25\text{ °C}; \text{red}$

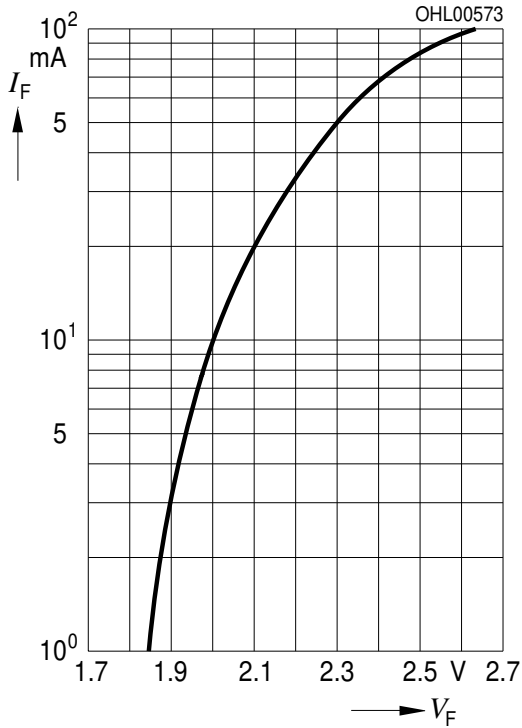

Relative Lichtstärke^{6) 7)} Seite 23

Relative Luminous Intensity^{6) 7)} page 23

$I_V/I_{V(20\text{ mA})} = f(I_F); T_A = 25\text{ °C}$

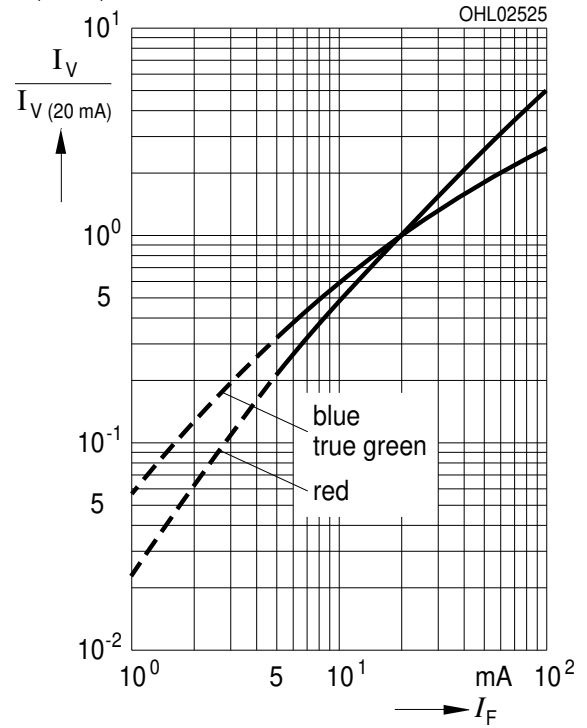

Durchlassstrom⁶⁾ Seite 23

Forward Current⁶⁾ page 23

$I_F = f(V_F); T_A = 25\text{ °C}; \text{blue, true green}$

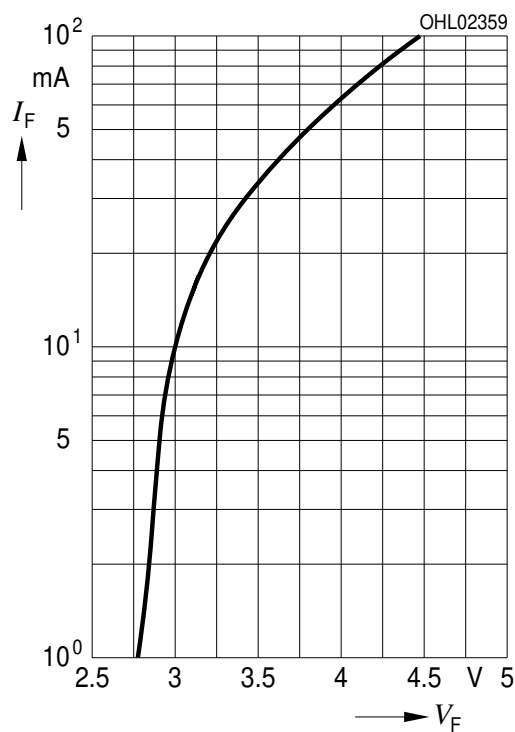

Relative Lichtstärke⁶⁾ Seite 23

Relative Luminous Intensity⁶⁾ page 23

$I_V/I_{V(25\text{ °C})} = f(T_A); I_F = 20\text{ mA}$

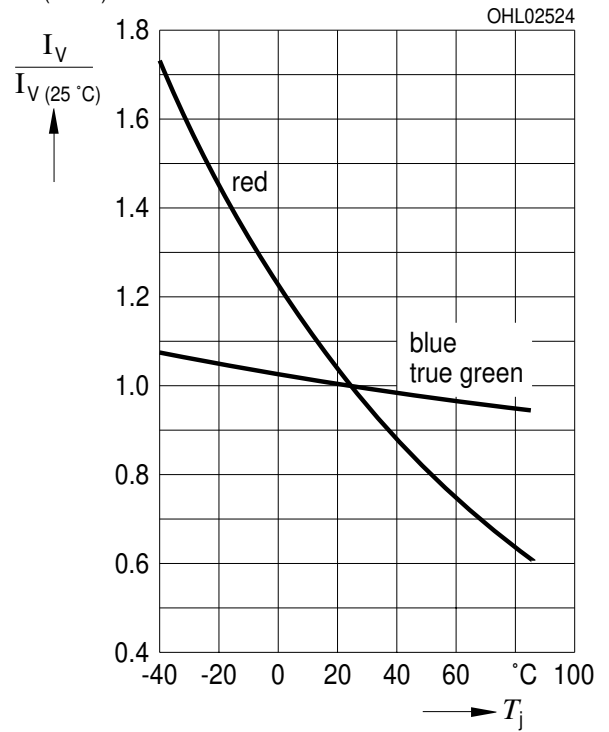

Dominante Wellenlänge⁶⁾ Seite 23

Dominant Wavelength⁶⁾ page 23

blue, $\lambda_{\text{dom}} = f(I_F); T_A = 25 \text{ }^\circ\text{C}$

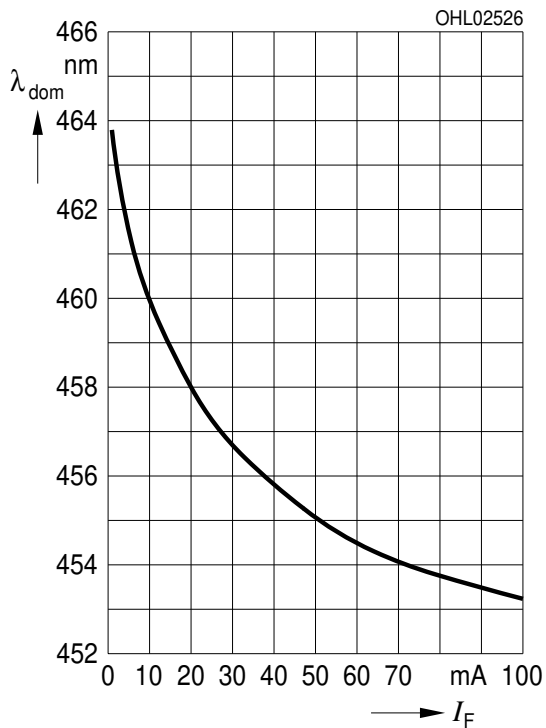

Dominante Wellenlänge⁶⁾ Seite 23

Dominant Wavelength⁶⁾ page 23

true green, $\lambda_{\text{dom}} = f(I_F); T_A = 25 \text{ }^\circ\text{C}$

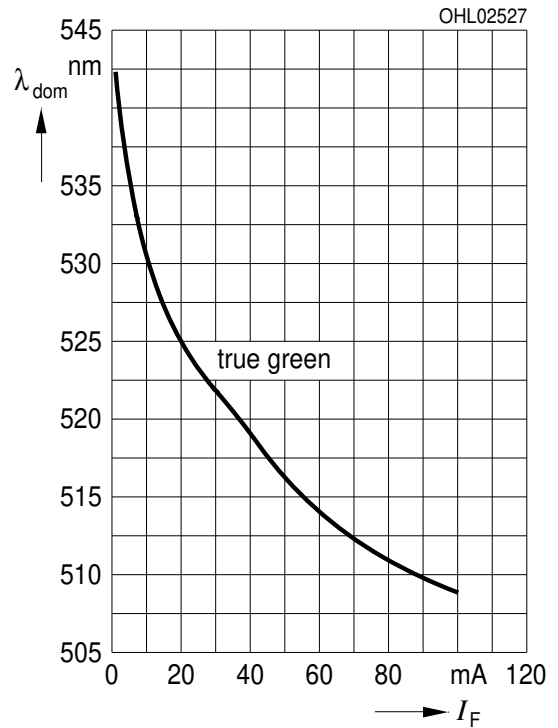

Maximal zulässiger Durchlassstrom rot
Max. Permissible Forward Current red
 $I_F = f(T)$; 1 chip on

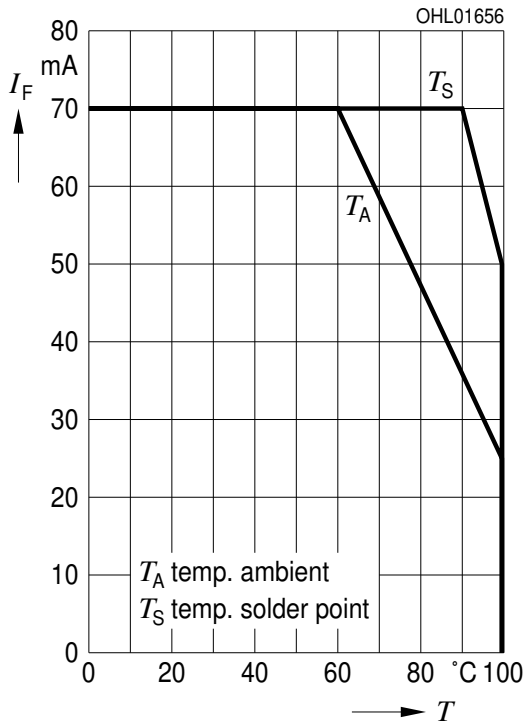

Maximal zulässiger Durchlassstrom rot
Max. Permissible Forward Current red
 $I_F = f(T)$; 3 chips on

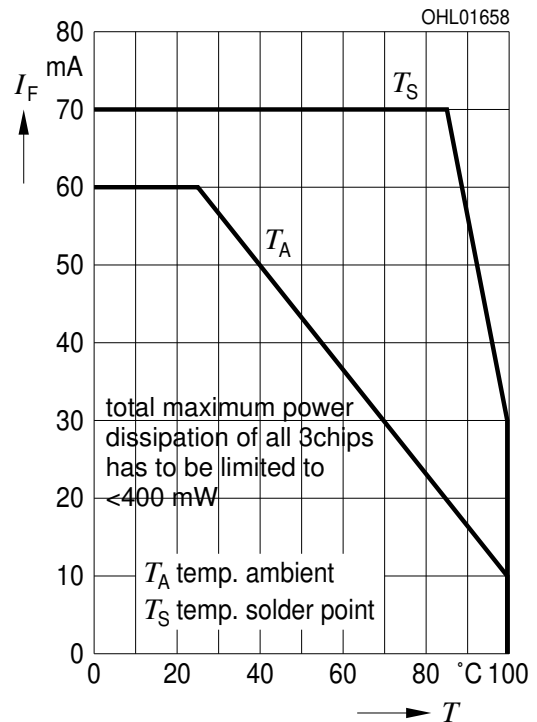

Maximal zulässiger Durchlassstrom true grün
Max. Permissible Forward Current true green
 $I_F = f(T)$; 1 chip on

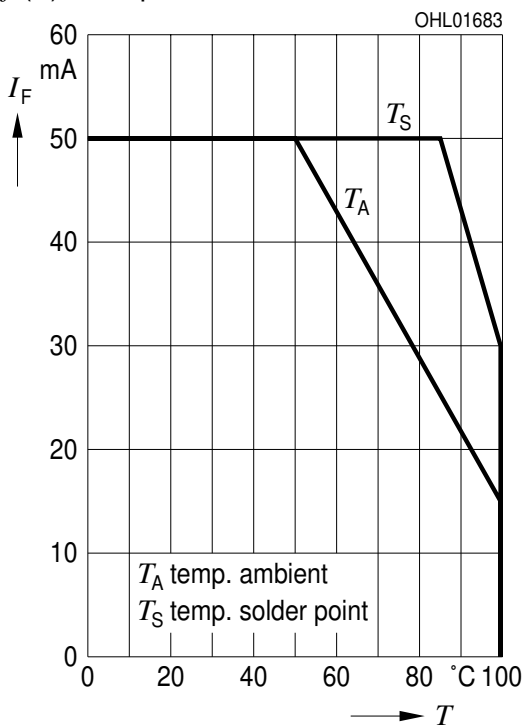

Maximal zulässiger Durchlassstrom true grün
Max. Permissible Forward Current true green
 $I_F = f(T)$; 3 chips on

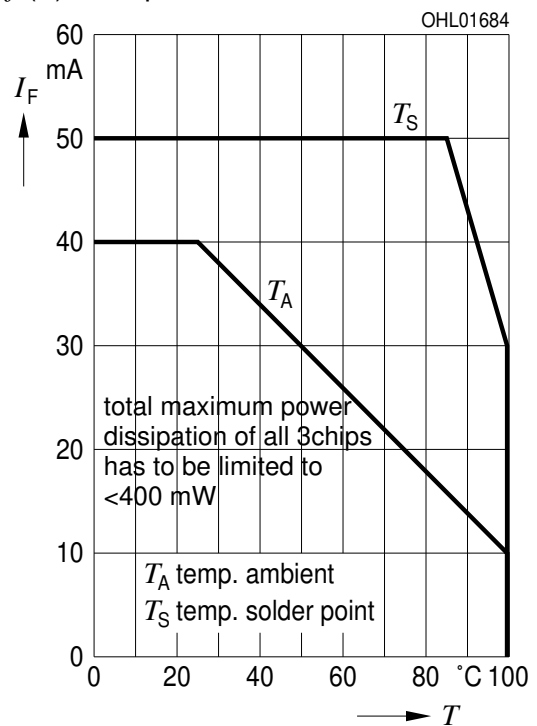

Maximal zulässiger Durchlassstrom blau
Max. Permissible Forward Current blue
 $I_F = f(T)$; 1 chip on

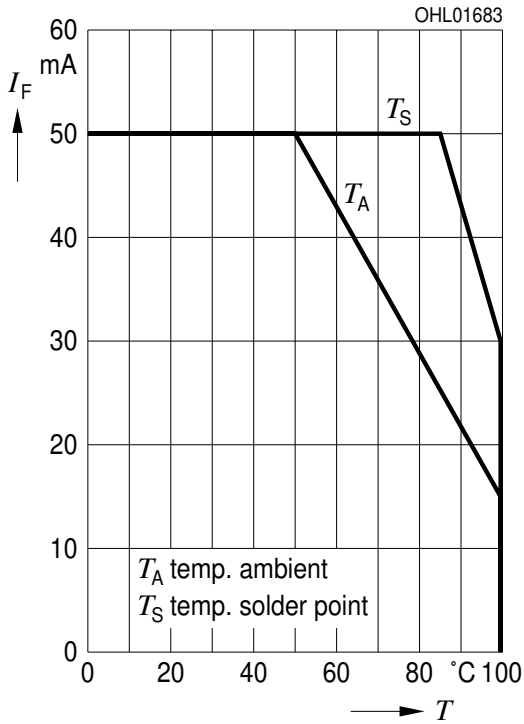

Maximal zulässiger Durchlassstrom blau
Max. Permissible Forward Current blue
 $I_F = f(T)$; 3 chips on

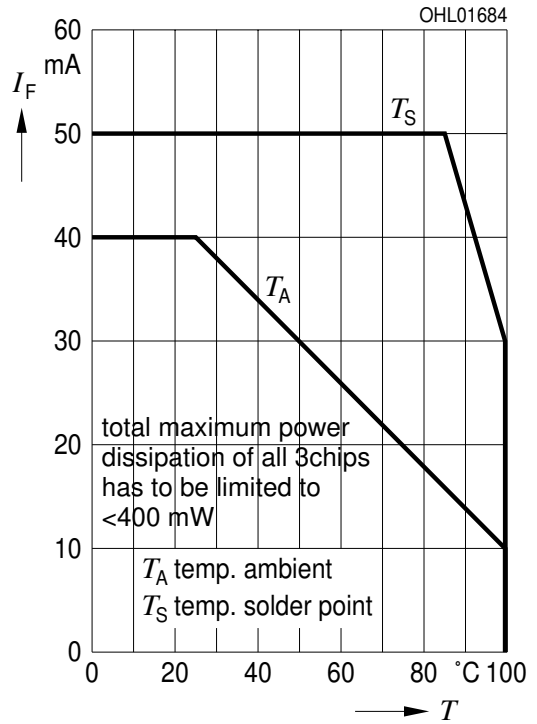

Zulässige Impulsbelastbarkeit
Permissible Pulse Handling Capability

Duty cycle $D = \text{parameter}$, $T_A = 25\text{ °C}$

$I_F = f(t_p)$; red (1 Chip on)

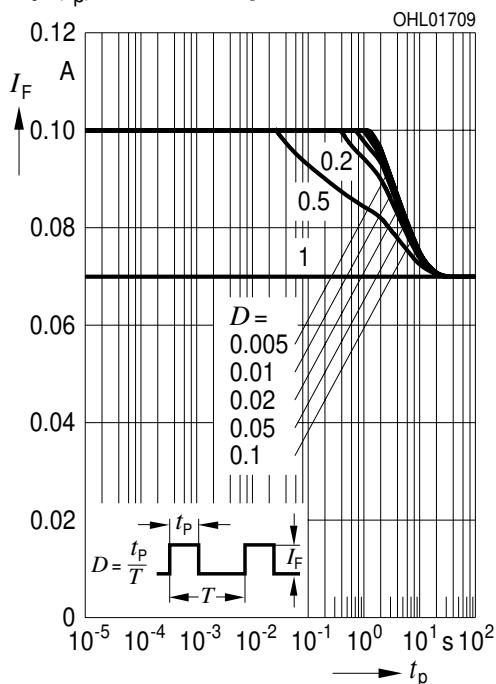

Zulässige Impulsbelastbarkeit
Permissible Pulse Handling Capability

Duty cycle $D = \text{parameter}$, $T_A = 85\text{ °C}$

$I_F = f(t_p)$; red (1 Chip on)

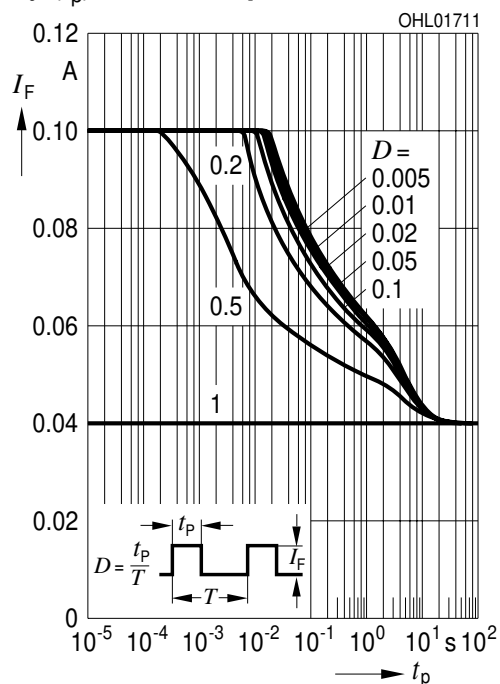

Zulässige Impulsbelastbarkeit
Permissible Pulse Handling Capability

Duty cycle $D = \text{parameter}$, $T_A = 25\text{ °C}$

$I_F = f(t_p)$; red (3 Chips on)

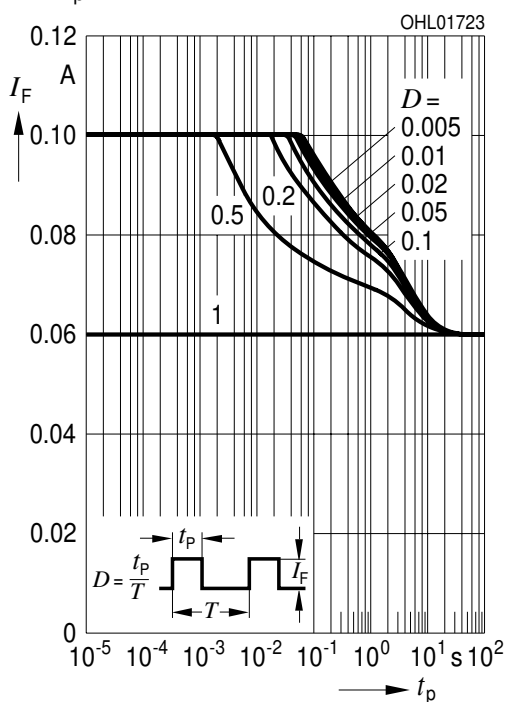

Zulässige Impulsbelastbarkeit
Permissible Pulse Handling Capability

Duty cycle $D = \text{parameter}$, $T_A = 85\text{ °C}$

$I_F = f(t_p)$; red (3 Chips on)

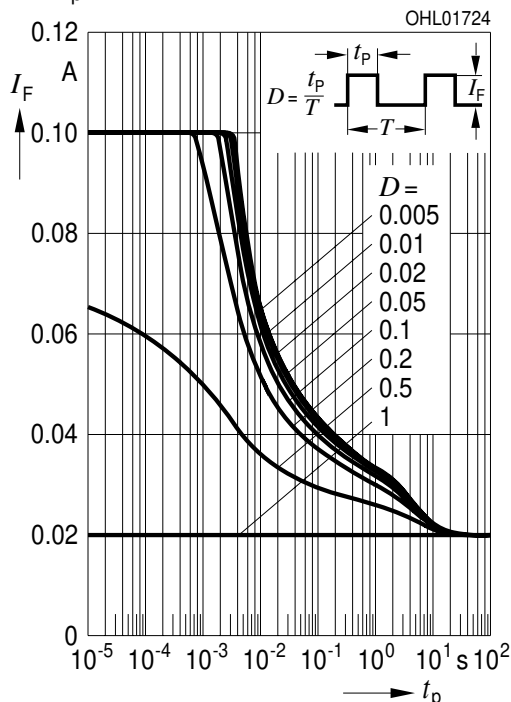

Zulässige Impulsbelastbarkeit
Permissible Pulse Handling Capability

Duty cycle $D =$ parameter, $T_A = 25\text{ °C}$

$I_F = f(t_p)$; true green (1 Chip on)

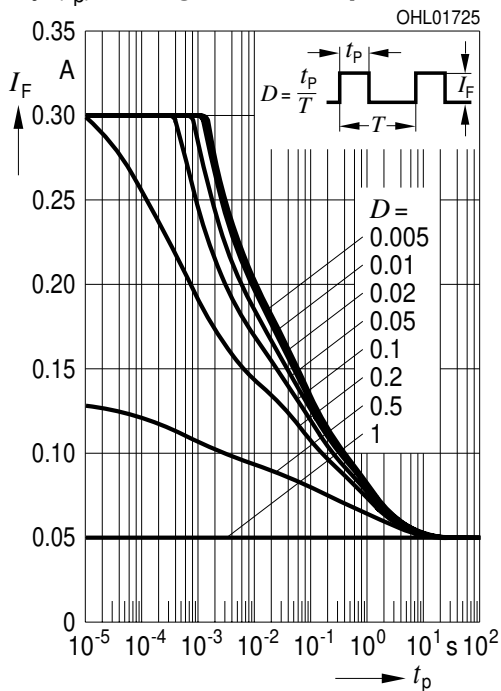

Zulässige Impulsbelastbarkeit
Permissible Pulse Handling Capability

Duty cycle $D =$ parameter, $T_A = 85\text{ °C}$

$I_F = f(t_p)$; true green (1 Chip on)

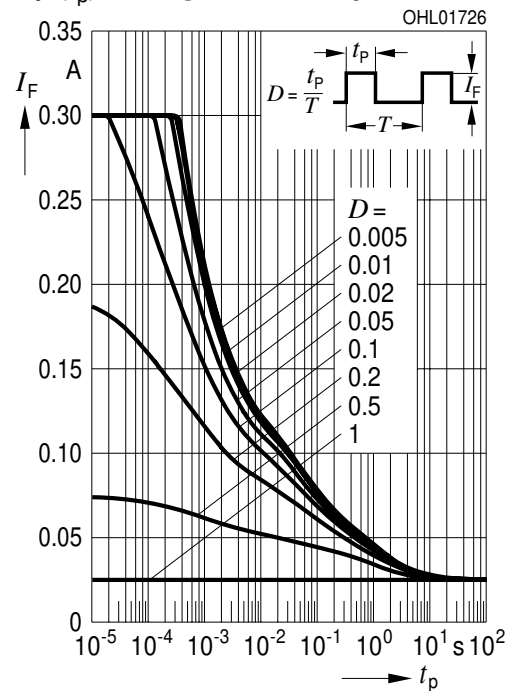

Zulässige Impulsbelastbarkeit
Permissible Pulse Handling Capability

Duty cycle $D =$ parameter, $T_A = 25\text{ °C}$

$I_F = f(t_p)$; true green (3 Chips on)

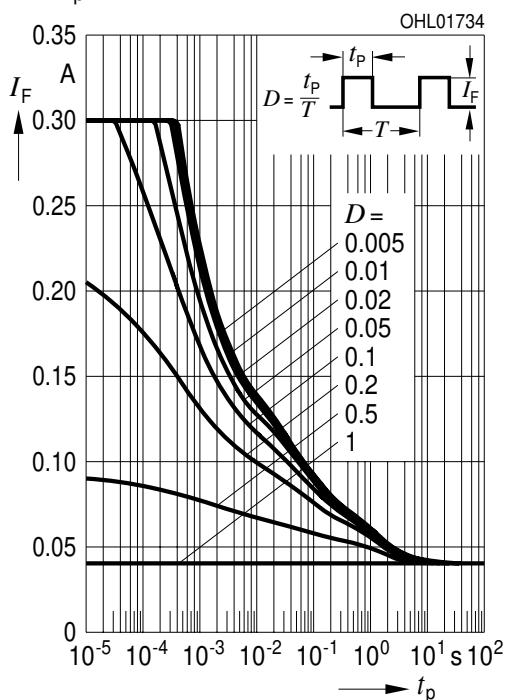

Zulässige Impulsbelastbarkeit
Permissible Pulse Handling Capability

Duty cycle $D =$ parameter, $T_A = 85\text{ °C}$

$I_F = f(t_p)$; true green (3 Chips on)

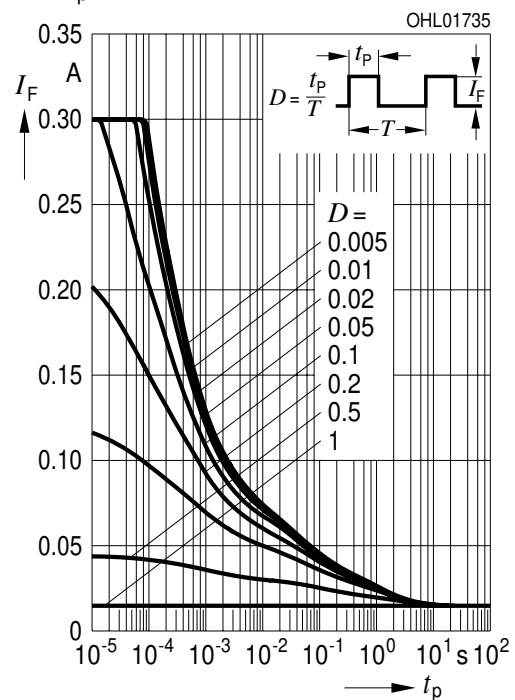

Zulässige Impulsbelastbarkeit
Permissible Pulse Handling Capability

Duty cycle $D = \text{parameter}$, $T_A = 25\text{ °C}$

$I_F = f(t_p)$; blue (1 Chip on)

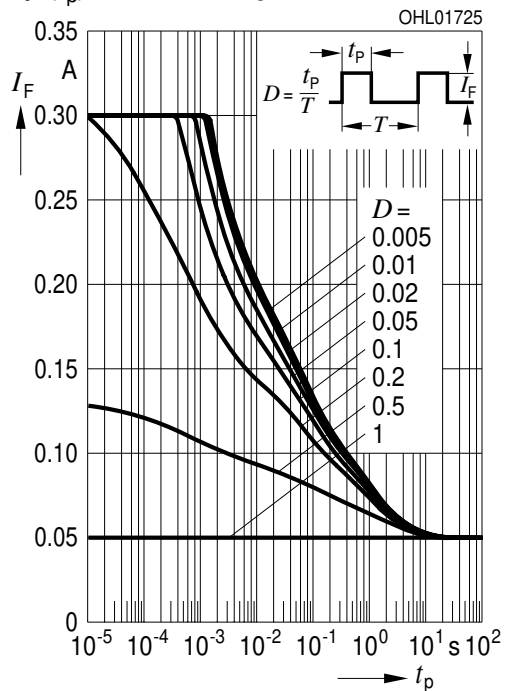

Zulässige Impulsbelastbarkeit
Permissible Pulse Handling Capability

Duty cycle $D = \text{parameter}$, $T_A = 85\text{ °C}$

$I_F = f(t_p)$; blue (1 Chip on)

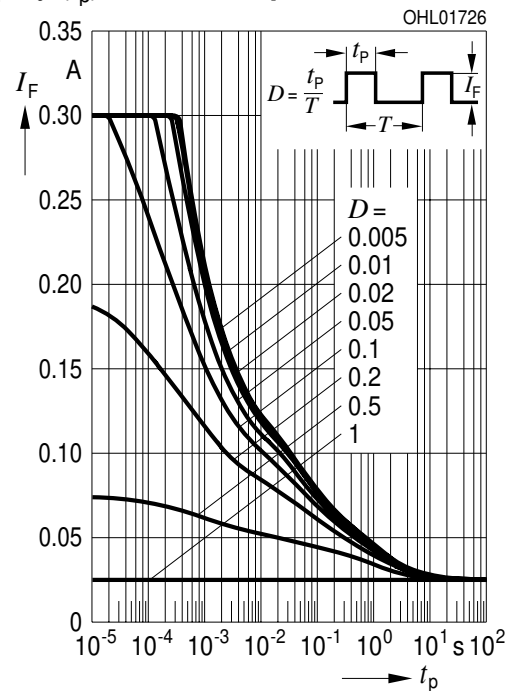

Zulässige Impulsbelastbarkeit
Permissible Pulse Handling Capability

Duty cycle $D = \text{parameter}$, $T_A = 25\text{ °C}$

$I_F = f(t_p)$; blue (3 Chips on)

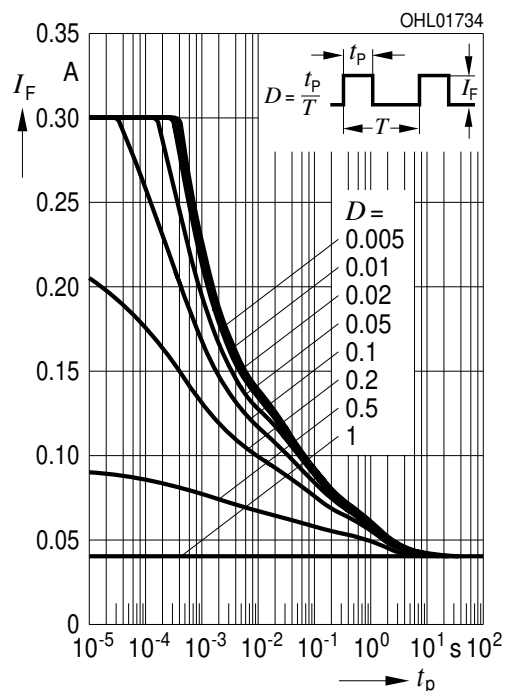

Zulässige Impulsbelastbarkeit
Permissible Pulse Handling Capability

Duty cycle $D = \text{parameter}$, $T_A = 85\text{ °C}$

$I_F = f(t_p)$; blue (3 Chips on)

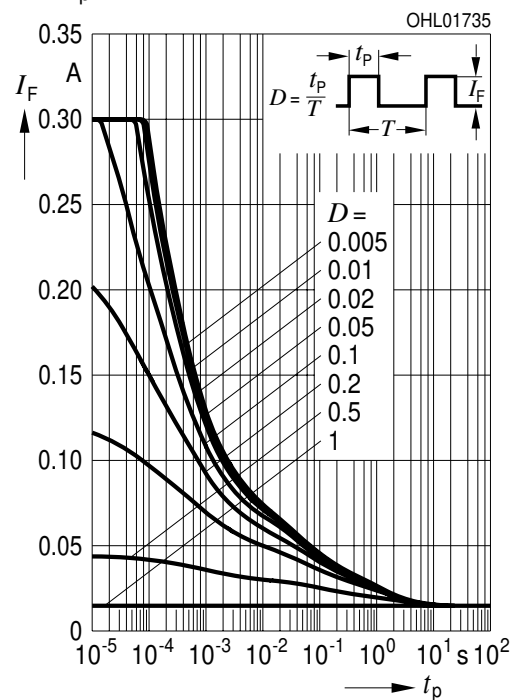

Maßzeichnung⁸⁾ Seite 23
 Package Outlines⁸⁾ page 23

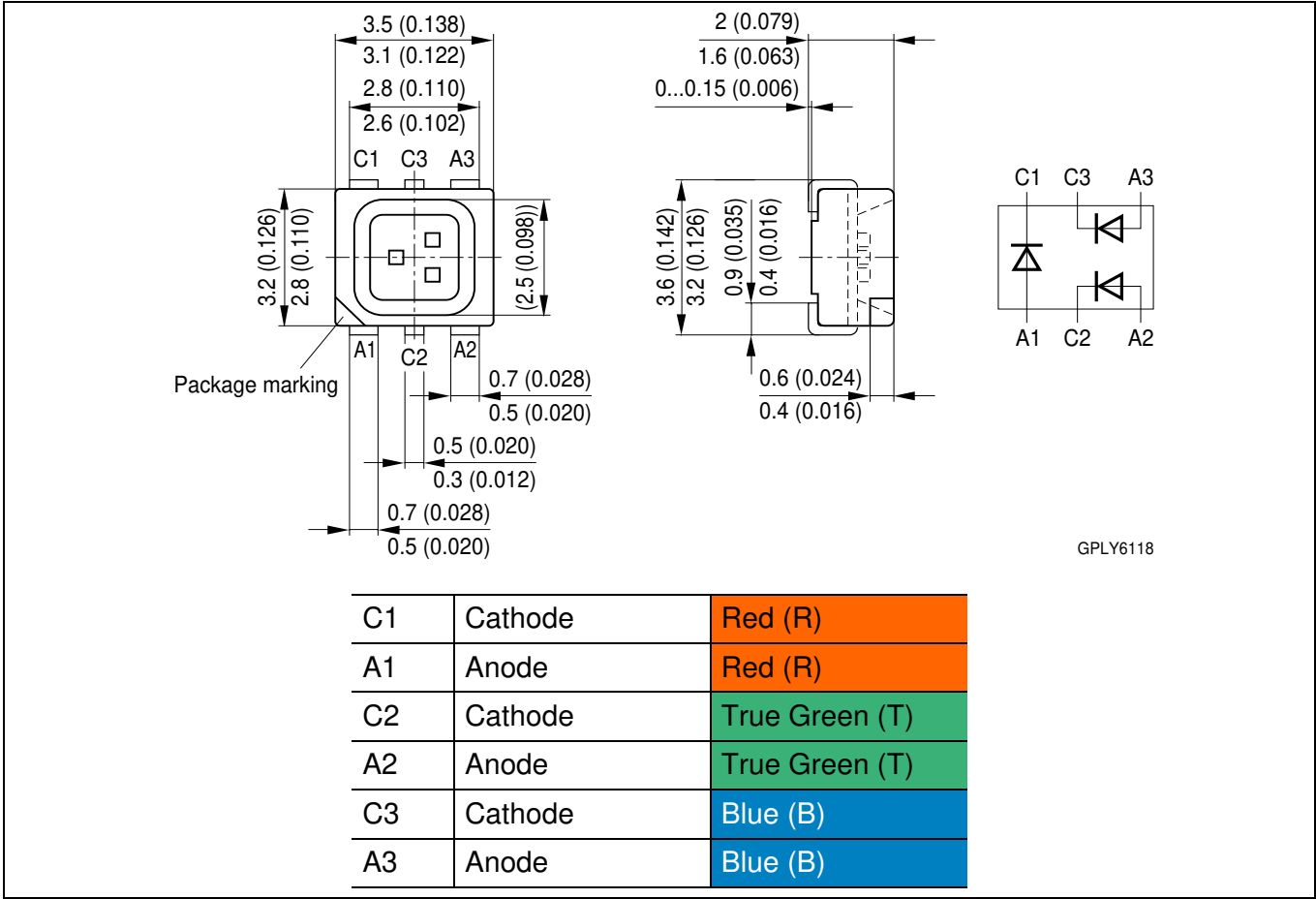

GPLY6118

Gewicht / Approx. weight: 40 mg

Gurtung / Polarität und Lage⁸⁾ Seite 23

Verpackungseinheit 1000/Rolle, ø180 mm
 oder 4000/Rolle, ø330 mm

Method of Taping / Polarity and Orientation⁸⁾ page 23

Packing unit 1000/reel, ø180 mm
 or 4000/reel, ø330 mm

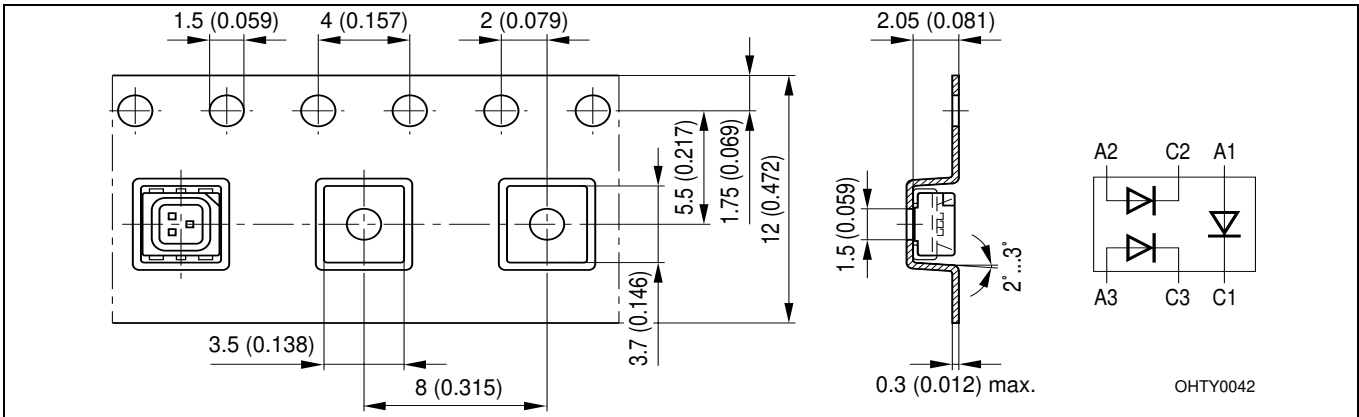

Empfohlenes Lötpaddesign^{8) 9) Seite 23}
Recommended Solder Pad^{8) 9) page 23}

Reflow Löten
 Reflow Soldering

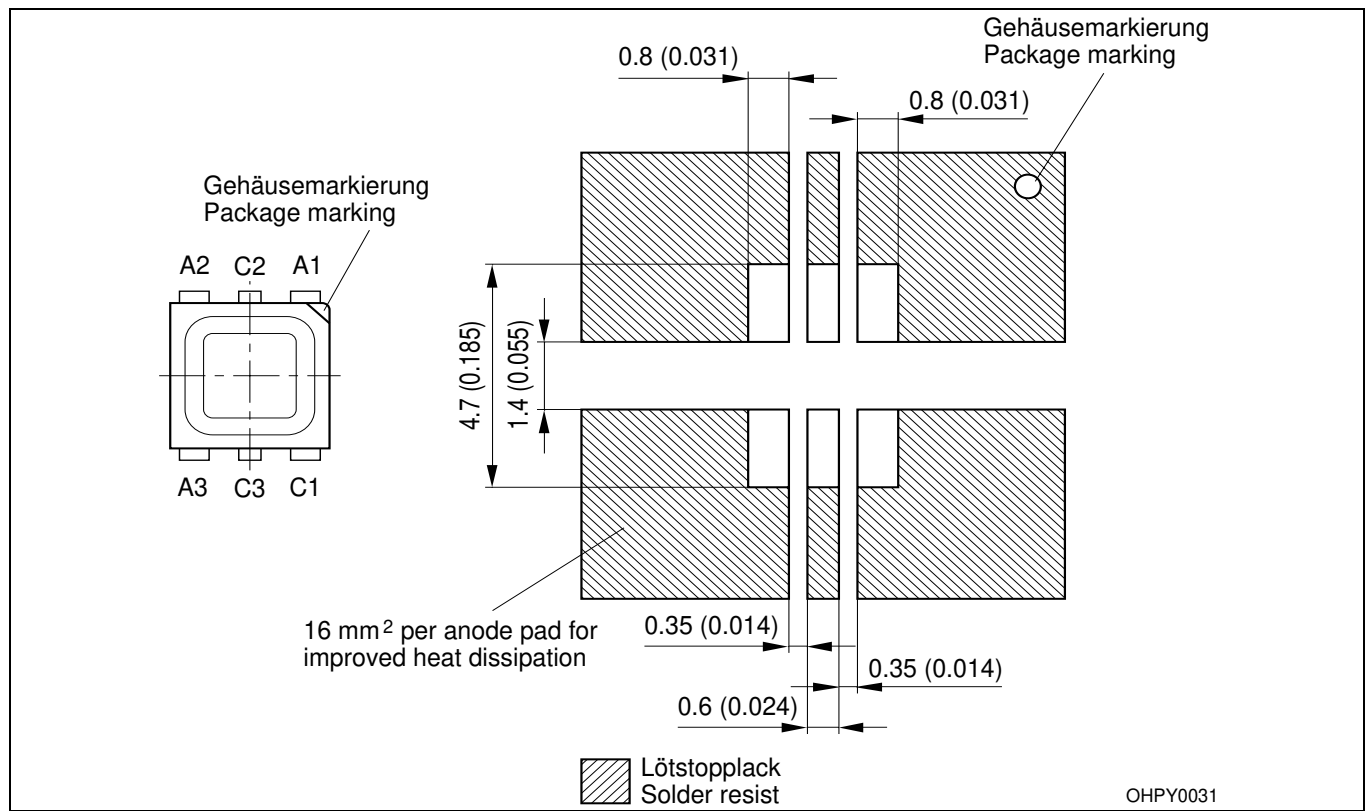

Empfohlenes Platinendesign für cluster mit 6-lead TOPLLED in Serienschaltung
Recommended PCB-Design for cluster with 6-lead TOPLLED in Series Connection

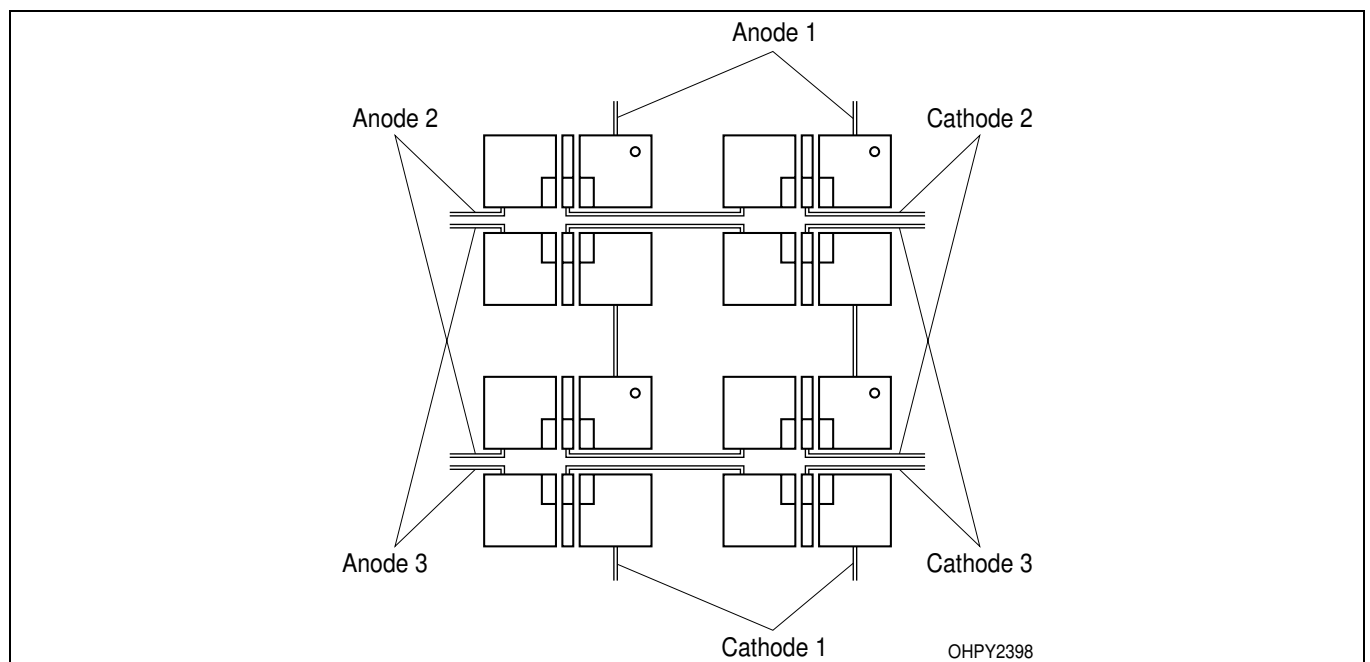

Lötbedingungen
Soldering Conditions

Vorbehandlung nach JEDEC Level 4
 Preconditioning acc. to JEDEC Level 4

Reflow Lötprofil für bleifreies Löten
Reflow Soldering Profile for lead free soldering

(nach J-STD-020D)
 (acc. to J-STD-020D)

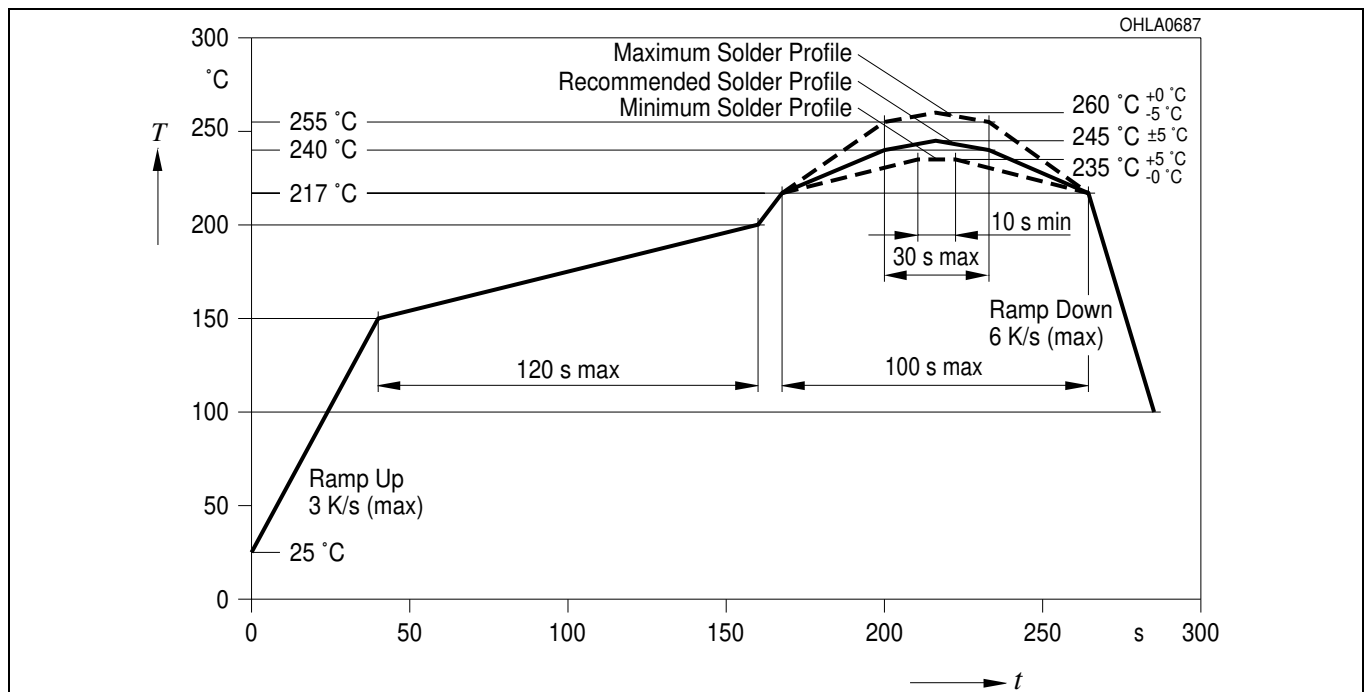

Barcode-Produkt-Etikett (BPL)
Barcode-Product-Label (BPL)

OSRAM Opto Semiconductors

Lxxx xxxx Bin1: Bin Information Color 1
 Product Name Bin2: Bin Information Color 2
 Bin3: Bin Information Color 3

(6P) BATCH NO: Batch Number
Bar Code

RoHS Compliant ML Temp ST
 2 245 C RT

(1T) LOT NO: Lot Number (9D) D/C: Date Code
Bar Code

Additional TEXT
 R077 DEMY
 PACKVAR: Packing Type

(X) PROD NO: Product Code (Q) QTY: Product Quantity per Reel (G) GROUP: X-X-X+X-X-X+X-X-X
 Color 1 Color 2 Color 3
 Forward Voltage Group
 Wavelength Group
 Brightness Group

OHA32043

Gurtverpackung
Tape and Reel

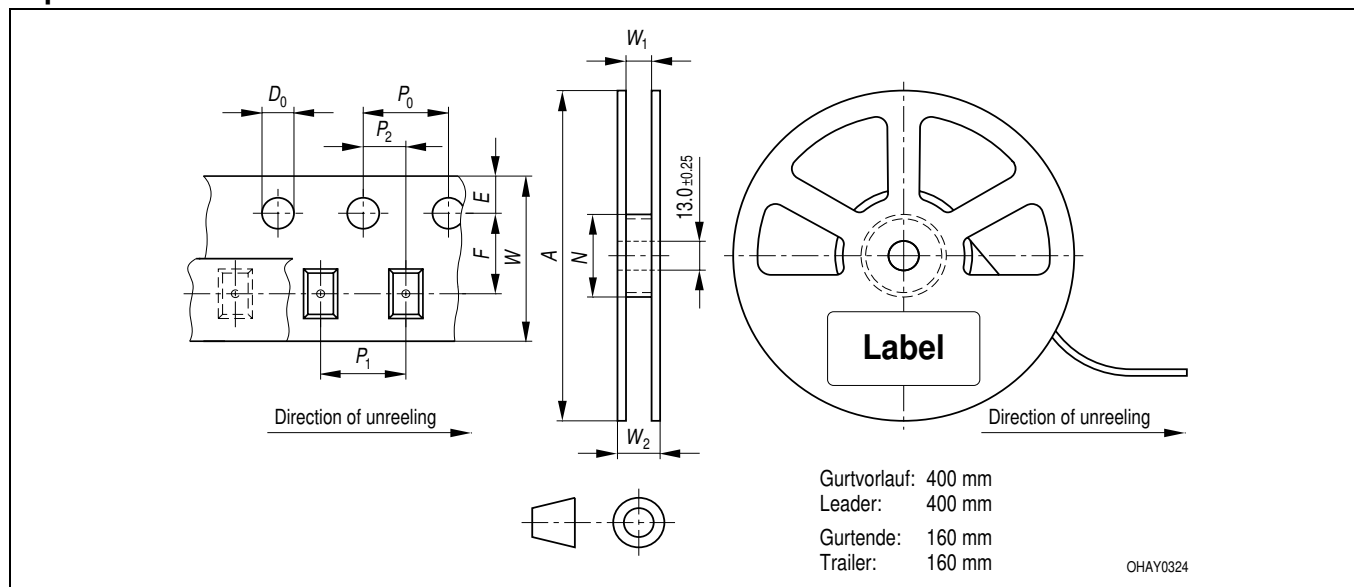

Tape dimensions in mm (inch)

W	P ₀	P ₁	P ₂	D ₀	E	F
12 ^{+0.3} _{-0.1}	4 ± 0.1 (0.157 ± 0.004)	8 ± 0.1 (0.315 ± 0.004)	2 ± 0.05 (0.079 ± 0.002)	1.5 ± 0.1 (0.059 ± 0.004)	1.75 ± 0.1 (0.069 ± 0.004)	5.5 ± 0.05 (0.217 ± 0.002)

Reel dimensions in mm (inch)

A	W	N _{min}	W ₁	W _{2 max}
180 (7)	12 (0.472)	60 (2.362)	12.4 + 2 (0.488 + 0.079)	18.4 (0.724)
330 (13)	12 (0.472)	60 (2.362)	12.4 + 2 (0.488 + 0.079)	18.4 (0.724)

Trockenverpackung und Materialien Dry Packing Process and Materials

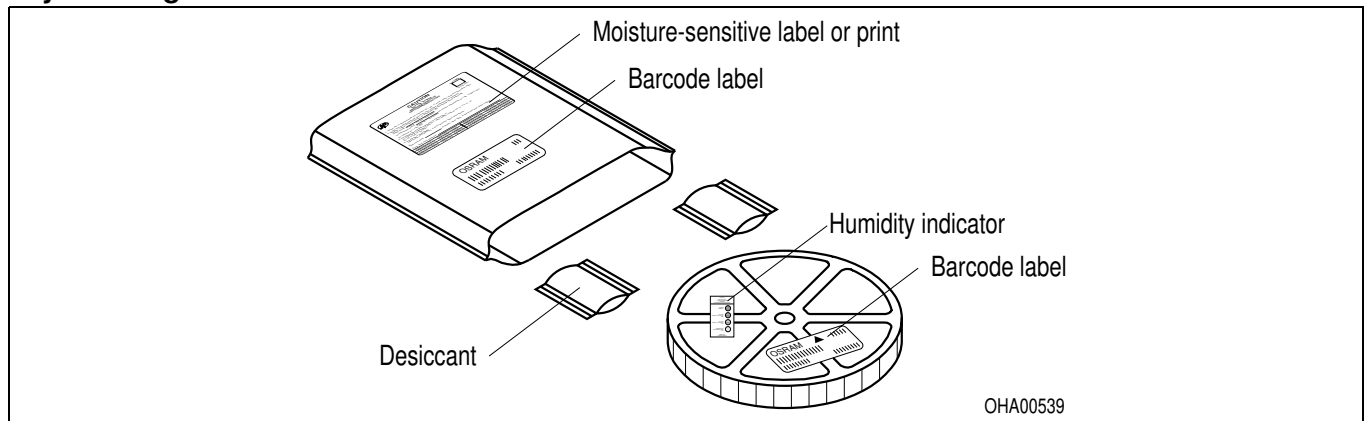

Anm.: Feuchteempfindliche Produkte sind verpackt in einem Trockenbeutel zusammen mit einem Trockenmittel und einer Feuchteindikatorkarte
Bezüglich Trockenverpackung finden Sie weitere Hinweise im Internet und in unserem Short Form Catalog im Kapitel "Gurtung und Verpackung" unter dem Punkt "Trockenverpackung". Hier sind Normenbezüge, unter anderem ein Auszug der JEDEC-Norm, enthalten.

Note: Moisture-sensitive product is packed in a dry bag containing desiccant and a humidity card.
Regarding dry pack you will find further information in the internet and in the Short Form Catalog in chapter "Tape and Reel" under the topic "Dry Pack". Here you will also find the normative references like JEDEC.

Kartonverpackung und Materialien Transportation Packing and Materials

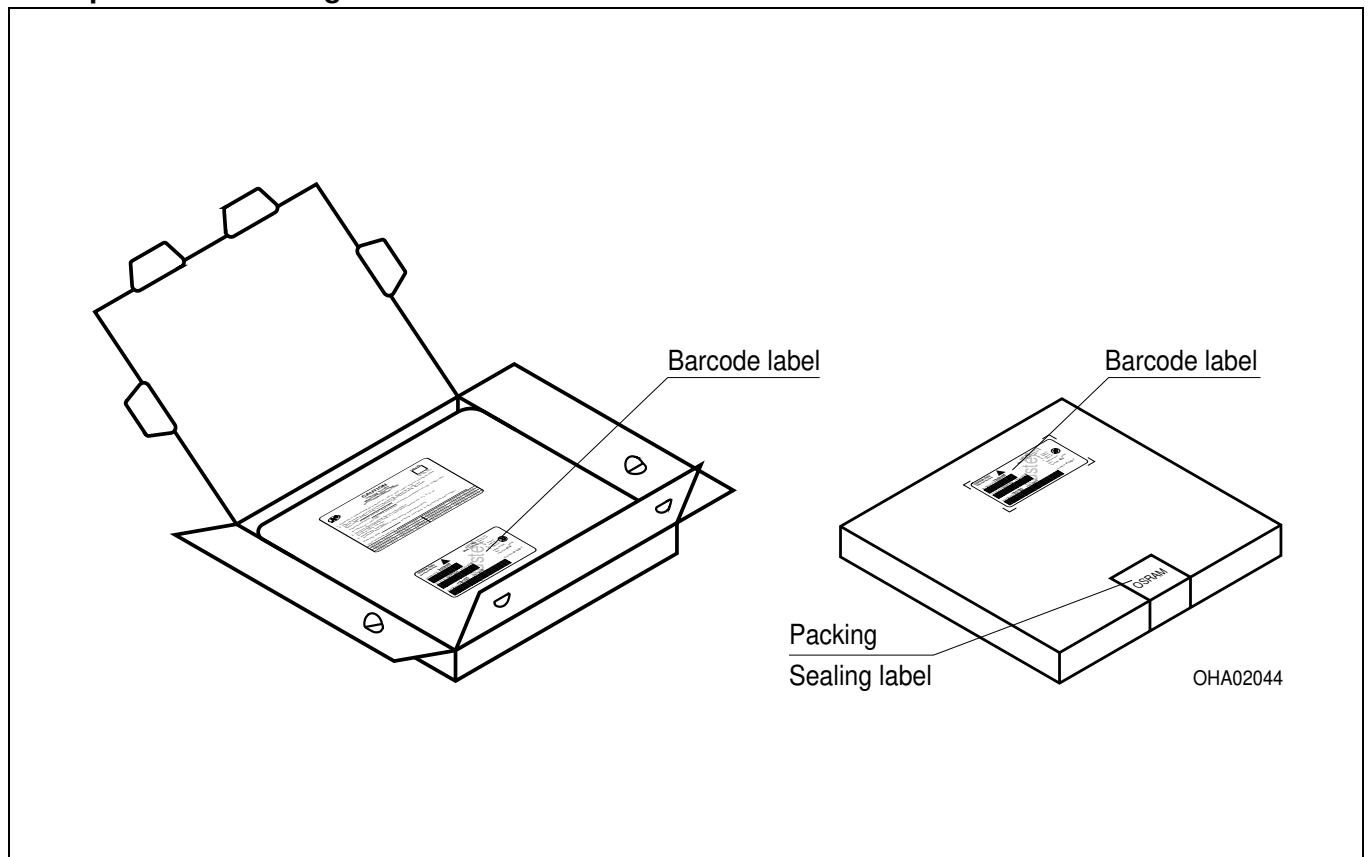

Revision History: 2009-10-14

Previous Version: 2007-08-08

Page	Subjects (major changes since last revision)	Date of change
1	acc. to OS-PCN-2006-006-A	2006-02-01
9	Relative Luminous Intensity	2006-03-31
4	acc. to OS-PCN-2006-006-A1-B	2006-05-04
2, 4, 7,8	new ordering code	2007-08-08
2, 6, 7	new ordering codes	2009-10-14

Attention please!

The information describes the type of component and shall not be considered as assured characteristics. Terms of delivery and rights to change design reserved. Due to technical requirements components may contain dangerous substances. For information on the types in question please contact our Sales Organization. If printed or downloaded, please find the latest version in the Internet.

Packing

Please use the recycling operators known to you. We can also help you – get in touch with your nearest sales office. By agreement we will take packing material back, if it is sorted. You must bear the costs of transport. For packing material that is returned to us unsorted or which we are not obliged to accept, we shall have to invoice you for any costs incurred.

Components used in life-support devices or systems must be expressly authorized for such purpose! Critical components^{10) page 23} may only be used in life-support devices or systems^{11) page 23} with the express written approval of OSRAM OS.

Fußnoten:

- 1) Helligkeitswerte werden mit einer Stromeinprägedauer von 25 ms und einer Genauigkeit von $\pm 11\%$ ermittelt.
- 2) Die LED kann kurzzeitig in Sperrichtung betrieben werden.
- 3) R_{thJA} ergibt sich bei Montage auf PC-Board FR 4 (Padgröße $\geq 16 \text{ mm}^2$ je Pad)
- 4) Wellenlängen werden mit einer Stromeinprägedauer von 25 ms und einer Genauigkeit von $\pm 1 \text{ nm}$ ermittelt.
- 5) Spannungswerte werden mit einer Stromeinprägedauer von 1 ms und einer Genauigkeit von $\pm 0,1 \text{ V}$ ermittelt.
- 6) Wegen der besonderen Prozessbedingungen bei der Herstellung von LED können typische oder abgeleitete technische Parameter nur aufgrund statistischer Werte wiedergegeben werden. Diese stimmen nicht notwendigerweise mit den Werten jedes einzelnen Produktes überein, dessen Werte sich von typischen und abgeleiteten Werten oder typischen Kennlinien unterscheiden können. Falls erforderlich, z.B. aufgrund technischer Verbesserungen, werden diese typischen Werte ohne weitere Ankündigung geändert.
- 7) Im gestrichelten Bereich der Kennlinien muss mit erhöhten Helligkeitsunterschieden zwischen Leuchtdioden innerhalb einer Verpackungseinheit gerechnet werden.
Dimmverhältnis im Gleichstrom-Betrieb max. 5:1 für red
- 8) Maße werden wie folgt angegeben: mm (inch)
- 9) Gehäuse hält TTW-Löthitze aus nach CECC 00802
- 10) Ein kritisches Bauteil ist ein Bauteil, das in lebenserhaltenden Apparaten oder Systemen eingesetzt wird und dessen Defekt voraussichtlich zu einer Fehlfunktion dieses lebenserhaltenden Apparates oder Systems führen wird oder die Sicherheit oder Effektivität dieses Apparates oder Systems beeinträchtigt.
- 11) Lebenserhaltende Apparate oder Systeme sind für
 - (a) die Implantierung in den menschlichen Körper oder
 - (b) für die Lebenserhaltung bestimmt.
 Falls sie versagen, kann davon ausgegangen werden, dass die Gesundheit und das Leben des Patienten in Gefahr ist.

Remarks:

- 1) Brightness groups are tested at a current pulse duration of 25 ms and a tolerance of $\pm 11\%$.
- 2) Driving the LED in reverse direction is suitable for short term application.
- 3) R_{thJA} results from mounting on PC board FR 4 (pad size $\geq 16 \text{ mm}^2$ per pad)
- 4) Wavelengths are tested at a current pulse duration of 25 ms and a tolerance of $\pm 1 \text{ nm}$.
- 5) Forward voltages are tested at a current pulse duration of 1 ms and a tolerance of $\pm 0.1 \text{ V}$.
- 6) Due to the special conditions of the manufacturing processes of LED, the typical data or calculated correlations of technical parameters can only reflect statistical figures. These do not necessarily correspond to the actual parameters of each single product, which could differ from the typical data and calculated correlations or the typical characteristic line. If requested, e.g. because of technical improvements, these typ. data will be changed without any further notice.
- 7) In the range where the line of the graph is broken, you must expect higher brightness differences between single LEDs within one packing unit.
Dimming range for direct current mode max. 5:1 for red
- 8) Dimensions are specified as follows: mm (inch)
- 9) Package able to withstand TTW-soldering heat acc. to CECC 00802
- 10) A critical component is a component used in a life-support device or system whose failure can reasonably be expected to cause the failure of that life-support device or system, or to affect its safety or the effectiveness of that device or system.
- 11) Life support devices or systems are intended
 - (a) to be implanted in the human body, or
 - (b) to support and/or maintain and sustain human life.
 If they fail, it is reasonable to assume that the health and the life of the user may be endangered.

Published by
OSRAM Opto Semiconductors GmbH
 Wernerwerkstrasse 2, D-93049 Regensburg
www.osram-os.com
 © All Rights Reserved.

EU RoHS and China RoHS compliant product



此产品符合欧盟 RoHS 指令的要求；

按照中国的相关法规和标准，不含有毒有害物质或元素。